

Poznoantična  
utrjena naselbina  
**Tonovcov grad**  
pri Kobaridu

Late Antique fortified settlement  
**Tonovcov grad**  
near Kobarid

**Najdbe**  
**Finds**

Zvezdana Modrijan  
Tina Milavec



Zbirka / Series  
Uredniki zbirke / Editors of the series

OPERA INSTITUTI ARCHAEOLOGICI SLOVENIAE 24  
Jana Horvat, Andrej Pleterski, Anton Velušček

Zvezdana Modrijan in / and  
Tina Milavec

POZNOANTIČNA UTRJENA NASELBINA TONOVCOV GRAD PRI KOBARIDU.  
NAJDBE  
LATE ANTIQUE FORTIFIED SETTLEMENT TONOVCOV GRAD NEAR KOBARID.  
FINDS

Recenzenta / Reviewed by  
Prevod / Translation  
Jezikovni pregled / Language Editors  
Tehnična ureditev / Technical Editor  
Oblikovanje ovitka /  
Front cover design  
Risbe / Drawings  
Računalniški prelom / DTP  
Priprava slikovnega gradiva /  
Preparation of illustrations  
Izdala in založila / Published by  
Zanju / Represented by  
Glavni urednik / Editor-in-Chief  
Tisk / Printed by

Jana Horvat, Mitja Guštin  
Sunčan Patrick Stone, Maja Sužnik, Tina Milavec, Zvezdana Modrijan, Borut Toškan  
Sonja Likar, Tinka H. Selič  
Mateja Belak  
Tamara Korošec  
Dragica Knific Lunder, Tamara Korošec  
Mateja Belak  
Drago Valoh, Mateja Belak  
Inštitut za arheologijo ZRC SAZU, Založba ZRC  
Oto Luthar, Jana Horvat  
Aleš Pogačnik  
Formatisk d. o. o., Ljubljana

Izid knjige sta podprla /  
Published with the support of

Javna agencija za knjigo RS, Znanstvenoraziskovalni center SAZU

Fotografija na ovitku /  
Front Cover photo

Tomaž Lauko

CIP - Kataložni zapis o publikaciji  
Narodna in univerzitetna knjižnica, Ljubljana

903/904(497.4Tonovcov grad)

MODRIJAN, Zvezdana

Poznoantična utrjena naselbina Tonovcov grad pri Kobaridu. Najdbe = Late antique fortified settlement Tonovcov grad near Kobarid. Finds / Zvezdana Modrijan, Tina Milavec; sodelavci Peter Kos ... [et al.]; [prevod Sunčan Patrick Stone ... [et al.]; risbe Dragica Knific Lunder, Tamara Korošec]. - Ljubljana : Inštitut za arheologijo ZRC SAZU, Založba ZRC, 2011. - (Opera Instituti Archaeologici Sloveniae, ISSN 1408-5208 ; 24)

ISBN 978-961-254-352-5

1. Milavec, Tina, 1979-

259569664

© 2011, ZRC SAZU, Inštitut za arheologijo, Založba ZRC

Vse pravice pridržane. Noben del te knjige ne sme biti reproduciran, shranjen ali prepisan v kateri koli obliki oz. na kateri koli način, bodisi elektronsko, mehansko, s fotokopiranjem, snemanjem ali kako drugače, brez predhodnega pisnega dovoljenja lastnikov avtorskih pravic.

All rights reserved. No part of this publication may be reproduced, stored in a retrieval system or transmitted, in any form or by any means, electronic, mechanical, photocopying, recording or otherwise, without the prior permission of the publisher.

Zvezdana Modrijan  
Tina Milavec

**POZNOANTIČNA UTRJENA NASELBINA  
TONOVCOV GRAD PRI KOBARIDU.  
NAJDBE**

Sodelavci: Peter KOS, Dragan BOŽIČ, Matija TURK, Petra LEBEN SELJAK,  
Borut TOŠKAN, Janez DIRJEC, Francesco BOSCHIN in K. Patrick FAZIOLI

**LATE ANTIQUE FORTIFIED SETTLEMENT  
TONOVCOV GRAD NEAR KOBARID.  
FINDS**

With contributions of Peter KOS, Dragan BOŽIČ, Matija TURK, Petra LEBEN SELJAK,  
Borut TOŠKAN, Janez DIRJEC, Francesco BOSCHIN and K. Patrick FAZIOLI



LJUBLJANA 2011

# VSEBINA

Predgovor (Zvezdana MODRIJAN in Tina MILAVEC).....	9
1. Uvod (Zvezdana MODRIJAN) .....	11
1.1 Kronologija .....	11
1.2 Stavbe .....	13
1.3 Grobovi .....	18
1.4 Literatura .....	20
2. Kovinske najdbe (Tina MILAVEC) .....	21
2.1 Stavba 1 .....	21
2.2 Stavbi 2 in 3 .....	64
2.3 Sklop cerkva, vmesni prostor in grobovi .....	68
2.4 Vodni zbiralnik .....	75
2.5 Literatura .....	75
3. Steklene najdbe (Tina MILAVEC) .....	83
3.1 Stavba 1 .....	83
3.2 Stavbi 2 in 3 .....	89
3.3 Sklop cerkva .....	89
3.4 Vodni zbiralnik .....	94
3.5 Okensko steklo .....	94
3.6 Sklep .....	95
3.7 Poznoantično steklo v Sloveniji .....	97
3.8 Literatura .....	115
4. Keramika (Zvezdana MODRIJAN) .....	121
4.1 Uvožena keramika .....	123
4.2 Groba keramika .....	158
4.3 Sklep .....	204
4.4 Literatura .....	212
5. Novčne najdbe (Peter KOS) .....	221
5.1 Katalog .....	221
5.2 Ovrednotenje novčnih najdb .....	229
5.3 Literatura .....	238
6. Prazgodovinske najdbe s Tonovcovega gradu in železnodobna kulturna mesta v Posočju (Dragan BOŽIČ) .....	239
6.1 Uvod .....	239
6.2 Najdbe iz starejše železne dobe .....	241
6.3 Najdbe iz mlajše železne dobe .....	251
6.4 Železnodobne najdbe s Tonovcovega gradu v primerjavi z najdbami v svetiščih in na kulturnih mestih .....	260
6.5 Kamniti artefakti s Tonovcovega gradu (Matija TURK) .....	269
6.6 Katalog .....	271
6.7 Literatura .....	273

# CONTENTS

Foreword (Zvezdana MODRIJAN and Tina MILAVEC) .....	9
1. Introduction (Zvezdana MODRIJAN) .....	11
1.1 Chronology .....	11
1.2 Structures .....	13
1.3 Graves .....	18
1.4 Bibliography .....	20
2. Metal finds (Tina MILAVEC) .....	21
2.1 Building 1 .....	21
2.2 Buildings 2 and 3 .....	64
2.3 The ecclesiastical complex, space between the churches and graves .....	69
2.4 Water cistern .....	75
2.5 Bibliography .....	75
3. Glass finds (Tina MILAVEC) .....	83
3.1 Building 1 .....	84
3.2 Buildings 2 and 3 .....	89
3.3 The ecclesiastical complex .....	91
3.4 Water cistern .....	95
3.5 Window glass .....	95
3.6 Conclusion .....	96
3.7 Late Antique glass in Slovenia .....	97
3.8 Bibliography .....	115
4. Pottery (Zvezdana MODRIJAN) .....	121
4.1 Imported pottery .....	123
4.2 Coarse ware .....	158
4.3 Conclusion .....	204
4.4 Bibliography .....	212
5. Coin finds (Peter KOS) .....	221
5.1 Catalogue .....	221
5.2 Evaluation of the coin finds .....	229
5.3 Bibliography .....	238
6. Prehistoric finds from Tonovcov grad and iron age cult places in the Posočje area (Dragan BOŽIČ) .....	239
6.1 Introduction .....	239
6.2 Early Iron Age finds .....	241
6.3 Late Iron Age finds .....	251
6.4 Iron Age finds from Tonovcov grad near Kobarid in comparison to finds from sanctuaries and cult places .....	260
6.5 Stone artefacts from Tonovcov grad (Matija TURK) .....	269
6.6 Catalogue .....	271
6.7 Bibliography .....	273

7. Antropološka analiza poznoantičnih skeletov (Petra LEBEN SELJAK) .....	279
7.1 Uvod, material in metode dela .....	279
7.2 Rezultati .....	280
7.3 Razprava in sklepi .....	295
7.4 Literatura .....	301
8. Sesalska makrofavna (Borut TOŠKAN in Janez DIRJEC) .....	303
8.1 Material in metode .....	303
8.2 Taksonomija .....	306
8.3 Porazdelitev najdb v času .....	315
8.4 Porazdelitev najdb v prostoru .....	325
8.5 Analiza velikosti .....	333
8.6 Paleoekonomija .....	350
8.7 Sklep .....	368
8.8 Literatura .....	370
8.9 Prilogi .....	375
9. Kratke ugotovitve o ptičjih ostankih (Francesco BOSCHIN) .....	389
10. Rezultati mikroskopske analize grobe keramike (K. Patrick FAZIOLI) .....	395
10.1 Uvod .....	395
10.2 Strategija vzorčenja .....	395
10.3 Metodologija .....	396
10.4 Rezultati .....	397
10.5 Tehnološke izbire .....	398
10.6 Sklepi .....	400
10.7 Literatura .....	405
11. Katalog (Zvezdana MODRIJAN in Tina MILAVEC) .....	407
Table .....	451
Seznam avtorjev .....	557

7. Anthropological analysis of the skeletons (Petra LEBEN SELJAK) .....	279
7.1 Introduction, material and methods .....	279
7.2 Results .....	280
7.3 Discussion and conclusions .....	296
7.4 Bibliography .....	301
8. Mammalian macrofauna (Borut TOŠKAN and Janez DIRJEC) .....	303
8.1 Materials and methods .....	304
8.2 Taxonomy .....	306
8.3 Diachronic distribution of finds .....	315
8.4 The spatial distribution of finds .....	325
8.5 Size analysis .....	333
8.6 Paleoeconomy .....	350
8.7 Conclusions .....	368
8.8 Bibliography .....	370
8.9 Appendices .....	375
9. Short considerations on the bird remains (Francesco BOSCHIN) .....	389
10. Results of microscopic compositional analysis on coarse-ware ceramics (K. Patrick FAZIOLI) .....	395
10.1 Introduction .....	395
10.2 Sampling Strategy .....	395
10.3 Methodology .....	396
10.4 Results .....	397
10.5 Technological Choices .....	398
10.6 Conclusions .....	400
10.7 Bibliography .....	405
11. Catalogue (Zvezdana MODRIJAN and Tina MILAVEC) .....	407
Plates .....	451
List of contributors .....	557





# PREDGOVOR

## FOREWORD

Zvezdana MODRIJAN, Tina MILAVEC

Pričujoča monografija je drugi od dveh delov objave rezultatov raziskav poznoantične višinske naselbine Tonovcov grad pri Kobaridu. Raziskave, ki jih je izvajal Inštitut za arheologijo ZRC SAZU, so s presledki potekale med letoma 1993 in 2004.

V prvem delu (S. Ciglencečki, Z. Modrijan, T. Milavec, *Poznoantična utrjena naselbina Tonovcov grad pri Kobaridu. Naselbinske najdbe in interpretacija / Late antique fortified settlement Tonovcov grad near Kobarid. Settlement remains and interpretation.* – Opera Instituti Archaeologici 23, 2011) so predstavljeni terenski izvidi, interpretacija izkopanih stavb in analiza pomena naselbine v času pozne antike. V pričujoči knjigi pa predstavljamo drobne najdbe, odkrite med izkopavanji.

Te zajemajo predvsem kovinske, steklene in keramične najdbe, obravnavani pa so tudi novci ter človeški in živalski kostni ostanki. Posebno poglavje je posvečeno prazgodovinskim najdbam.

Obdelava številnih najdb je zahtevala sodelovanje mnogih posameznikov in inštitucij. Najprej bi se radi zahvalili sodelavcem Kobariškega muzeja, posebej direktorju Jožetu Šerbcu, za razumevanje in podporo med izkopavanji in med prvo postizkopavalno obdelavo najdb. Jana Šubic Prisljan iz Goriškega muzeja je opravila konservacijo vsega kovinskega gradiva. Večina dela pa je bilo opravljenega v okviru Inštituta za arheologijo ZRC SAZU. Dragica Knific Lunder in Tamara Korošec sta gradivo zrisali, Mateja Belak in Drago Valoh pa pripravila karte in ostalo slikovno gradivo. Tekste sta skrbno prebrali in predlagali mnoge izboljšave Jana Horvat in Andreja Dolenc Vičič. Posamezni poglavji sta prebrala še Laszlo Bartosiewicz (Sesalska makrofavna) in Irena Lazar (Steklene najdbe).

Najdbe s Tonovcovega gradu so bile tema dveh doktorskih nalog na Oddelku za arheologijo Filozofske fakultete umiverze v Ljubljani (Tina Milavec, Primerjalna analiza kovinskega gradiva poznoantičnih naselbin vzhodnoalpskega prostora, Ljubljana 2008; Zvezdana Modrijan, Poznoantična groba kuhinjska keramika ter uvoženo posodje z območja Slovenije in Furlanije, Ljubljana 2008). Pri tem bi se radi zahvalili mentorju Slavku

This book is the second of two volumes of the research results from the Late Antique fortified hilltop settlement of Tonovcov grad near Kobarid. The excavations, led by the Institute of archaeology at ZRC SAZU, were performed between 1993 and 2005 with short discontinuations.

In the first volume (S. Ciglencečki, Z. Modrijan, T. Milavec, *Poznoantična utrjena naselbina Tonovcov grad pri Kobaridu. Naselbinske najdbe in interpretacija / Late antique fortified settlement Tonovcov grad near Kobarid. Settlement remains and interpretation.* – Opera Instituti Archaeologici 23, 2011) the field reports, interpretation of the excavated structures and the analysis of the importance of the settlement in Late Antiquity are presented.

The present volume presents small finds discovered during the excavations. These are represented mostly by metal, glass and pottery but also by human and animal remains. One chapter is devoted to the prehistoric finds.

The processing of numerous finds demanded the cooperation of many individuals and institutions. Firstly we would like to thank the colleagues from the Kobariški muzej in Kobarid, especially the director Jože Šerbec, for their understanding and support. Jana Šubic Prisljan from Goriški muzej in Nova Gorica undertook the conservation of all the metal finds. Most of the work was done at the Institute of archaeology at ZRC SAZU. The finds were drawn by Dragica Knific Lunder and Tamara Korošec and the maps and graphic material were prepared by Mateja Belak and Drago Valoh. The texts were read and improved by Jana Horvat and Andreja Dolenc Vičič. Chapter Mammalian macrofauna was read by Laszlo Bartosiewicz and chapter Glass finds was read by Irena Lazar.

The finds from Tonovcov grad were the topic of two doctoral theses at the Department of Archaeology at the Faculty of Arts, University of Ljubljana (Tina Milavec, Primerjalna analiza kovinskega gradiva poznoantičnih naselbin vzhodnoalpskega prostora, Ljubljana 2008; Zvezdana Modrijan, Poznoantična groba kuhinjska keramika ter uvoženo posodje z območja Slovenije in Furlanije, Ljubljana 2008). We would like to thank our

Ciglencečkemu za pomoč in razumevanje ob nastajanju nalog ter Vereni Vidrih Perko za pomoč pri obdelavi keramičnega gradiva.

Vsem naštetim, pa tudi mnogim neomenjenim, še enkrat iskrena hvala.

supervisor Slavko Ciglencečki for his help and understanding during the writing and to Verena Vidrih Perko for her help with the evaluation of the pottery.

To all mentioned, and also to many others, we are sincerely grateful.

# 1. UVOD

## 1. INTRODUCTION

Zvezdana MODRIJAN

Velika večina vseh najdb je bila odkrita v izkopnem polju bivalne stavbe 1. V ostalih objektih, stavbah 2 in 3, sklopu treh cerkva in v vodnem zbiralniku (*sl. 1.1*) je bilo drobnega gradiva bistveno manj, kar lahko pojasnimo z namembnostjo objektov in njihovo ohranjenostjo. Stavba 2 glede na odsotnost ognjišča v njeni notranjosti verjetno ni bila namenjena bivanju. Stavbi 3 pripadajoče kulturne plasti so zelo skromno ohranjene, saj jih je bila večina uničena ob izgradnji stavbe 2. Cerkve kot javne zgradbe pa so že v osnovi opremljene drugače kot bivalni objekti. Tudi v vodnih zbiralnikih predstavljajo drobne najdbe izjemo, zato njihovo skromno število ne preseneča.

Zaradi boljše preglednosti bodo v tem uvodu kratko povzeta kronologija najdišča z glavnimi fazami poselitve, opis raziskanih stavbnih ostankov in grobov. Širši opisi in opredelitve so zbrani v prvi knjigi (Tonovcov grad. Naselbinski ostanki in interpretacija, pogl. 2.2).

### 1.1 KRONOLOGIJA

Prostor naselbine Tonovcov grad pri Kobaridu je bil s prekinitvami poseljen od prazgodovine do srednjega veka. Glavno obdobje uporabe naselbine, iz katerega so bile raziskane tudi stavbne ostaline, spada v poznoantično obdobje, ki je razdeljeno v dve poselitveni fazi.

Iz prazgodovinskega obdobja so bile raziskane plasti brez stavbnih ostankov. Drobne najdbe spadajo v dolgo obdobje med paleolitikom in bronasto dobo (glej pogl. 6).

V mlajših, antičnih in poznoantičnih plasteh je bilo odkritih nekaj posameznih drobnih najdb, ki spadajo v starejšo in mlajšo železno dobo, vendar nismo naleteli na pripadajoče plasti ali arhitekturo (glej pogl. 6.1–6.3).

Iz 1. in 2. st. je bilo v poznoantičnih plasteh odkritih nekaj novcev in drobnih najdb. V ta čas lahko spadajo tudi najstarejše antične plasti pod stavbo 3, vendar tega zaradi pogostega pojavljanja starejših predmetov v mlajših plasteh ne moremo potrditi. Podobno velja za obdobje prve faze poselitve višinskih naselbin v Sloveniji, ki spada v zadnjo tretjino 3. st. (Ciglenečki 1990,

The large majority of all finds was discovered in the excavation area of the dwelling house (building 1). In other structures, buildings 2 and 3, the ecclesiastical complex of three churches and in the water cistern (*Fig. 1.1*), much less material was found which can be explained by the function and state of preservation of the structures. Building 2 had no fireplace and consequently probably did not function as a dwelling house. The cultural layers belonging to structure 3 were only modestly preserved as most of them were destroyed during the construction of building 2. Churches are public buildings and therefore differently equipped than dwelling houses. Also in water cisterns finds are generally rare so their small number is not surprising.

For better understanding of this volume chronology of this site with the main occupation phases, the description of the excavated structures and graves will be shortly summarized. Comprehensive descriptions and definitions are available in the first volume (Tonovcov grad. Settlement remains and interpretation, chapter 2.2).

### 1.1 CHRONOLOGY

The site of Tonovcov grad near Kobarid was – with discontinuations – settled from the prehistory to the Middle Ages. The architectural remains belong to Late Antiquity which is the main period of occupation and can be divided into two settlement phases.

From prehistory only layers and no structures are known. Discovered small finds belong to the long period between Palaeolithic and Bronze Age (see chapter 6).

In younger, Antique and Late Antique layers, some individual finds from the early and late Iron Age were found but no stratigraphy or architecture (see chapters 6.1–6.3).

Some coins and small finds, found in Late Antiquity layers, belong to the 1<sup>st</sup> and 2<sup>nd</sup> centuries. Also the earliest Antique layers under building 3 could belong to this period but as older objects are very often found in younger layers on the site this cannot be confirmed with certainty. The situation is similar with the period

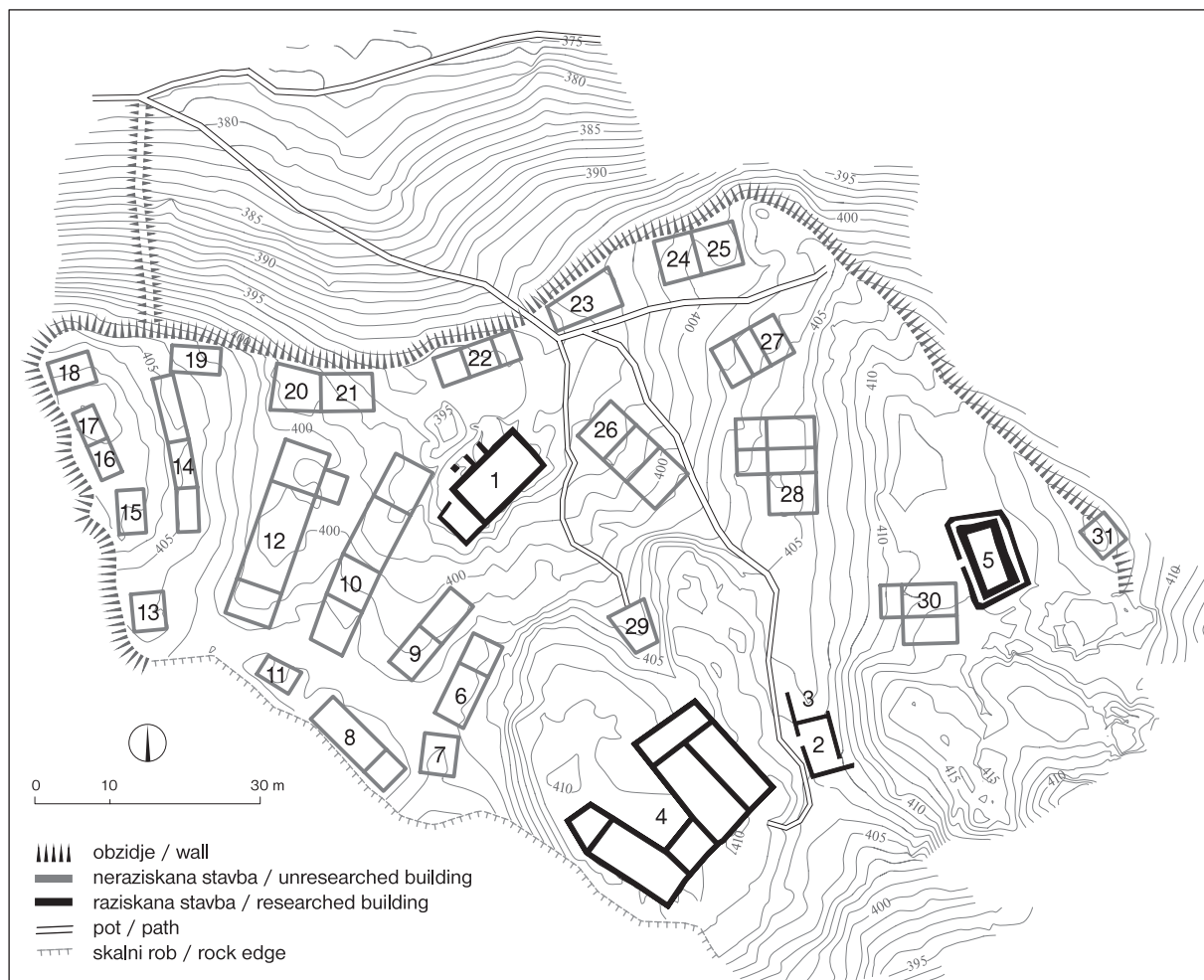

Sl. 1.1: Tonovcov grad. Načrt najdišča z raziskanimi (št. 1–5) in v reliefu površine (št. 6–31) nakazanimi stavbami (Tonovcov grad. Naselbinski ostanki in interpretacija, sl. 1.7).

Fig. 1.1: Tonovcov grad. Site plan of the settlement with the researched buildings (Nos. 1-5) and the buildings (Nos. 6-31) that can be seen in the surface (Tonovcov grad. Settlement remains and interpretation, Fig. 1.7).

154–156; 1999, 292). Iz tega časa so pogosti predvsem novci (13,5 % vseh najdenih novcev; glej pogl. 5.2).

Prve zanesljive ostanke arhitekture poznamo iz poznoantičnega obdobja, v katerega spadata dve poselitveni fazi Tonovcovega gradu. Iz prve poznoantične faze (druga polovica 4. in začetek 5. st.) so bili poleg novcev in drobnih najdb odkriti tudi ostanke zidanih objektov, to so zidovi ene ali dveh stavb pod kasnejšo stavbo 1, in stavba 3. Skoraj polovica vseh rimskih novcev iz obdobja 1.–5. stoletja (48 %) je bila kovana v drugi polovici 4. stoletja, novčni obtok pa je dokaj močan še v prvi četrtini 5. st (glej pogl. 5.2.1)

Druga in glavna poselitvena faza, v katero spada večina odkritih objektov, je datirana med konec 5. in začetek 7. st. V tem času so stali stavbi 1 in 2, sklop treh cerkva z "memorijo" in v skalo vklesanim vmesnim prostorom ter vodni zbiralnik. Faza je datirana na podlagi bogatih kovinskih in keramičnih najdb, medtem ko

of the first occupation phase of the hilltop settlements in Slovenia from the last third of the 3<sup>rd</sup> century (Ciglencečki 1990, 154–156; 1999, 292). Mostly coins were discovered from this period (13.5 % of all found coins; see chapter 5.2).

First definite architectural remains belong to the Late Antiquity, which is divided into two settlement phases. Beside coins and small finds, found in younger layers, wall remains of one or two structures under later building 1 and building 3 belong to the first Late Antiquity phase (second half of the 4<sup>th</sup>-beginning of the 5<sup>th</sup> century). Almost a half of all discovered coins from the time between the 1<sup>st</sup>-5<sup>th</sup> century (48%) was minted in the second half of the 4<sup>th</sup> century and the coin circulation remained strong even in the first quarter of the 5<sup>th</sup> century (see chapter 5.2.1).

The second and main settlement phase, where most of the excavated structures belong to, is dated between

novčni obtok v tem času skoraj presahne (iz konca 5. in iz 6. st. je bilo najdenih le pet vzhodnogotskih in en bizantinski novce; glej pogl. 5.2.2).

Iz zgodnjerednjeveškega obdobja je bilo raziskanih nekaj plasti in grobov vkopanih v delno porušene ostanke poznoantične naselbine. Spadajo grobo v čas med 7. in 9. st. in lahko predstavljajo eno ali več kratkih obdobij zadrževanja ljudi na prostoru naselbine (Tonovcov grad. Naselbinski ostanke in interpretacija, pogl. 2.2.4).

V srednjeveško obdobje spada le nekaj posamičnih drobnih najdb ter morda še neraziskani ostanke arhitekture na zahodnem robu naselbine, ki bi lahko predstavljali obrambni stolp (objekt št. 13; *sl. 1.1*; Tonovcov grad. Naselbinski ostanke in interpretacija, pogl. 2.2.5).

## 1.2 STAVBE

Na Tonovcovem gradu so bile raziskane stavbe 1, 2 in 3, sklop treh cerkva z vmesnim prostorom in vodni zbiralnik (*sl. 1.1*; glej Tonovcov grad. Naselbinski ostanke in interpretacija, pogl. 2, 3).

### 1.2.1 STAVBA 1

V prvi poznoantični fazi so na prostoru kasnejše stavbe 1 ob vhodu v naselbino stali zidani objekti, ki pa jih natančno ne moremo rekonstruirati, saj jih je v večini uničila gradnja kasnejše stavbe. Najdeni ostanke treh zidov kažejo, da sta morda na tem območju stali dve stavbi.

V drugi poznoantični fazi je bila sezidana stavba 1 s prizidkom in vetrolovom (*sl. 1.2*; glej tudi Tonovcov grad. Naselbinski ostanke in interpretacija, pogl. 2.3, 3.1; pril. 1). Ognjišči v glavnem prostoru in v prizidku ter velika količina najdb kažejo, da je šlo za stanovanjski objekt. Med najdbami prevladuje keramika (glej pogl.

the end of the 5<sup>th</sup> and the beginning of the 7<sup>th</sup> century. In this period buildings 1 and 2, the ecclesiastical complex with a 'memoria' and a space cut into the bedrock between the churches as well as the water cistern functioned. The phase is dated using rich metal and pottery finds whereas coin circulation was discontinued in this period (only one Byzantine and five Ostrogothic coins were discovered from the end of the 5<sup>th</sup> and from the 6<sup>th</sup> century; see chapter 5.2.2).

Some small finds, layers and graves, dug into at least partly demolished remains of the Late Antique settlement, belong to the Early Medieval period. Roughly they can be dated between the 7<sup>th</sup> and 9<sup>th</sup> century and can represent one or several short occupations of the site (Tonovcov grad. Settlement remains and interpretation, chapter 2.2.4).

Some individual finds and perhaps also an unresearched structure on the western edge of the settlement, which could represent a defence tower, belong to the Middle Ages (building No. 13; *Fig. 1.1*; Tonovcov grad. Settlement remains and interpretation, chapter 2.2.5).

## 1.2 BUILDINGS

Buildings 1, 2, 3, an ecclesiastical complex with a space cut into the bedrock between the churches and a water cistern were excavated on Tonovcov grad (*Fig. 1.1*; see Tonovcov grad. Settlement remains and interpretation, chapters 2, 3).

### 1.2.1 BUILDING 1

In the first Late Antiquity phase masonry structures stood in the area of the later building 1 by the settlement entrance but as they were mostly destroyed by the construction of the later building they cannot be

*Tab. 1.1:* Stavba 1. Preglednica stratigrafskih enot (SE) (Tonovcov grad. Naselbinski ostanke in interpretacija, tab. 2.1).

*Tab. 1.1:* Building 1. Table of stratigraphic units (SU) (Tonovcov grad. Settlement remains and interpretation, tab. 2.1).

Opredeflitev / Definition	SE / SU
Sterilna / Sterile	40
Prazgodovina / Prehistory	33, 39
PA 1 / LA 1	04, 16, 17, 20, 29a, 30, 31, 32, 36=68, 36a, 36b, 51, 53, 54, 57, 66, 68, 75, 76, 77, 78; zidovi / walls 13, 14, 15
PA 1/ PA 2 / LA 1/ LA 2	18, 21, 22, 24, 63, 74
PA 2 / LA 2	03, 05, 12, 14, 23=26, 25, 28, 29, 35a, 50, 55, 56, 62, 64, 67; zidovi / walls 1, 2, 3, 4, 5, 6, 7, 8, 9, 10, 11, 12
Rušenje / Destruction	01, 08, 11, 13
ZSV / EMP	09, 10
Premešano / Mixed	02, 06, 34

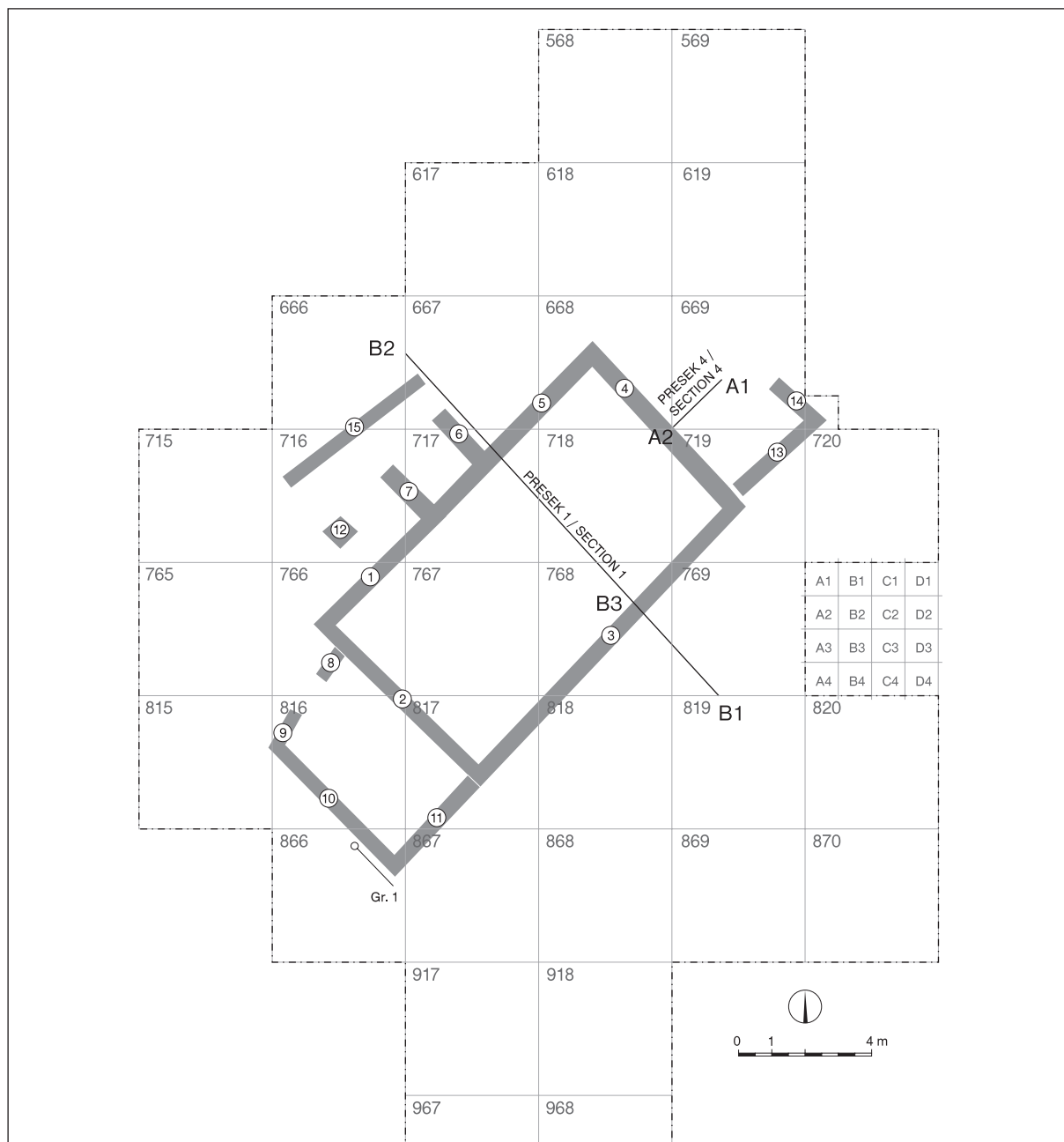

Sl. 1.2: Tloris stavbe 1 z mejo izkopnega polja in mrežo kvadrantov. M. = 1:200 (Tonovcov grad. Naselbinski ostanki in interpretacija, sl. 2.2).

Fig. 1.2: Ground plan of building 1 with the excavation area and quadrant grid. Scale = 1:200 (Tonovcov grad. Settlement remains and interpretation, Fig. 2.2).

4), med katero je daleč največ grobega hišnega posodja (glej pogl. 4.2). Uvožena keramika pa kaže, da je tudi v drugi poznoantični fazi naselbina še vedno vzdrževala stike s sredozemskim prostorom.

Nekeramično gradivo, najdeno znotraj stavbe 1 in v njeni neposredni okolici, je značilno za samooskrbne staroselske naselbine jugovzhodnoalpskega prostora: kovinski deli hišne opreme, orodje, moška in ženska noša, orožje (glej pogl. 2) ter stekleni kozarci na visoki

precisely reconstructed. Found remains of three walls indicate that two buildings could have stood in the area.

In the second Late Antiquity phase building 1 with an outhouse and a wind shield was built (Fig. 1.2; see also Tonovcov grad. Settlement remains and interpretation, chapters 2.3, 3.1; insert 1). Fireplaces in both the house and the outhouse and a large quantity of finds point to the dwelling character of the building. Pottery prevails among the finds (see chapter 4) and among pottery

nogi (glej pogl. 3). Prestižnejši uvoženi predmeti ter predmeti germanskega značaja niso pogosti.

Potem ko je bila stavba 1 deloma že porušena, je bila še enkrat uporabljena za bivanje. Zgodnjersrednjeveške plasti so bile na izkopnem polju stavbe 1 ugotovljene samo v notranjosti objekta 1 in tu so bile zgoščene tudi vse značilne zgodnjersrednjeveške najdbe (Tonovcov grad. Naselbinski ostanki in interpretacija, pogl. 3.1.4; sl. 3.16).

### 1.2.2 STAVBI 2 IN 3

Pod skalnim platojem, na katerem stoji sklop cerkva, so bili odkriti ostanki zidov, ki pripadajo dvema različnima stavbama (sl. 1.3). Stavbi sta bili povezani med seboj, čeprav sta živeli v časovno različnih obdobjih. Najprej je bila v prvi poznoantični fazi postavljena stavba 3, od katere se je v celotni dolžini ohranil le južni zid, delno pa še dva nanj prizidana zidova. Na južni zid stavbe 3 so bili, ko je bil ta že delno porušen, prizidani zidovi stavbe 2, ki je živela v času druge poznoantične faze (glej Tonovcov grad. Naselbinski ostanki in interpretacija, pogl. 2.4, 3.2). Odsotnost ognjišča ter skromne najdbe v notranjosti stavbe 2 kažejo, da ta verjetno ni bila namenjena bivanju. Po drugi strani so bile dokaj bogate drobne najdbe iz časa 6. in začetka 7. st. na njeni severni

coarse ware is predominant (see chapter 4.2). Imported pottery shows that in the second Late Antiquity phase the settlement still retained contacts with the Mediterranean.

Metal finds from building 1 and the area around it is characteristic of the autarkic Romanized settlements of the Southeastern Alps: architectural fittings, tools, male and female attire, weapons (see chapter 2) and glass stemmed goblets (see chapter 3). Luxurious imported and Germanic objects are not numerous.

After the building had been partly demolished it was once again used for dwelling. Early Medieval layers were only discovered inside building 1 and all the characteristic Early Medieval finds were concentrated there (Tonovcov grad. Settlement remains and interpretation, chapter 3.1.4; Fig. 3.16).

### 1.2.2 BUILDINGS 2 AND 3

Under the rocky plateau with the ecclesiastical complex remains of walls belonging to two different buildings were discovered (Fig. 1.3). The buildings were connected even though they functioned in two different periods of time. In the first Late Antiquity phase building 3 was erected of which only the southern wall was preserved in its entire length with two partly preserved ones added to it. After building 3 was demolished walls of structure 2, which functioned in the second Late Antiquity phase, were added to the southern wall of building 3 (see Tonovcov grad. Settlement remains and interpretation, chapters 2.4, 3.2). The lack of a fireplace and modest finds inside building 2 indicate that it was probably not used for dwelling. On the other hand rather numerous finds from the 6<sup>th</sup> and the beginning of the 7<sup>th</sup> century were found on its northern side, in the area of the former building 3 (SU 150). Some tools,

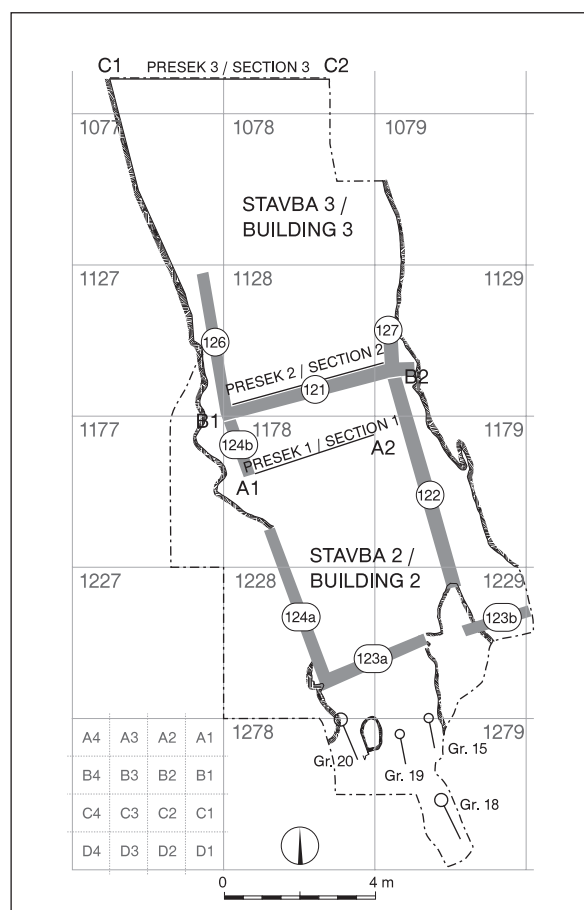

Sl. 1.3: Stavbi 2 in 3 z mejo izkopnega polja in mrežo kvadrantov. M. = 1:200 (Tonovcov grad. Naselbinski ostanki in interpretacija, sl. 2.34).

Fig. 1.3: Ground plan of building 1 with the excavation area and quadrant grid. Scale = 1:200 (Tonovcov grad. Settlement remains and interpretation, Fig. 2.34).

Tab. 1.2: Stavbi 2 in 3. Preglednica stratigrafskih enot (SE) (Tonovcov grad. Naselbinski ostanki in interpretacija, tab. 2.2).

Tab. 1.2: Buildings 2 and 3. Table of stratigraphic units (SU) (Tonovcov grad. Settlement remains and interpretation, tab. 2.2).

Opredelitev / Definition	SE / SU
Sterilna / Sterile	117, 139, 143, 151, 157, 173, 176, 178, 183
Prazgodovina / Prehistory	180=140
Antika / Antiquity	171, 172=165, 177, 179
PA 1 / LA 1	121, 126, 127, 160, 170, 175
PA 1/PA 2 / LA 1/LA 2	142, 174
PA 2 / LA 2	103, 106, 108, 110, 111, 112, 113, 120, 122, 123, 124, 147, 150=144, 152, 155, 158, 161, 162, 164, 166, 169
ZSV / EM	grob / grave 18, grobovi / graves 15?, 19?, 20?
Premešano / Mixed	135, 137

zunanj strani, na območju starejše stavbe 3 (SE 150). Nekaj kosov orodja, več koščkov bronaste in svinčene pločevine, stari predmeti in polizdelek sponke verižice bi morda lahko kazali na izdelavo ali vsaj predelavo manjših bronastih predmetov na tem prostoru (glej pogl. 2.2.1).

Za južnim zidom stavbe 2 je bila najdena skupina grobov, med katerimi lahko enega (grob 18) na podlagi pridatkov okvirno datiramo v 8. st. (glej pogl. 2.2).

fragments of bronze and lead sheet, old objects and a half-finished necklace clasp could indicate manufacture or at least mending of small bronze objects in this area (see chapter 2.2.1).

Behind the southern wall of building 2 a group of graves was found, according to the grave goods one of them could be roughly dated to the 8<sup>th</sup> century (see chapter 2.2).

### 1.2.3 SKLOP CERKVA

Na skalnem platoju na južnem delu naselbine so bile v drugi poznoantični fazi postavljene tri cerkve (sl. 1.4). Vse tri sodijo med preproste pravokotne enoladijske cerkve s prosto stoječo klopjo za duhovnike. Severna in osrednja cerkev sta bili med seboj povezani v celotni dolžini, prezbiterij južne cerkve pa je s prezbiterijem osrednje povezoval štirikoten zidan vmesni prostor. Prostor med ladjama je bil vglobljen v skalno osnovo, vendar nepozidan (sl. 1.5). Vse tri cerkve so imele prizidane nartekse (glej Tonovcov grad. Naselbinski ostanki in interpretacija, pogl. 2.5, 3.3; pril. 4).

Ruševine cerkve so bile v zgodnjem srednjem veku ponovno izkoriščene. Na to kaže ostanek kurišča s keramiko v osrednji cerkvi ter v ruševino vkopan grob 21 (Tonovcov grad. Naselbinski ostanki in interpretacija, pogl. 3.3.6).

### 1.2.3 ECCLESIASTICAL COMPLEX

On the rocky plateau in the southern part of the settlement three churches were built in the second Late Antiquity phase (Fig. 1.4). All of them are simple hall one-nave churches with a free standing clergy bank. The north and the main church are connected along their entire length while the presbytery of the south church is linked to the presbytery of the main church by a lateral square space in-between. The space between the naves was cut into the bedrock but unbuilt (Fig. 1.5). All three churches had narthices added to them (see Tonovcov grad. Settlement remains and interpretation, chapters 2.5, 3.3; insert 4).

Ruins of the churches were used again in the Early Middle Ages. This is indicated by a fireplace with pottery finds in the main church and a grave (grave 21) dug into the destruction layer (Tonovcov grad. Settlement remains and interpretation, chapter 3.3.6).

### 1.2.4 VODNI ZBIRALNIK

Na najvišjem, vzhodnem platoju naselbine, je bil postavljen vodni zbiralnik (sl. 1.6) pravokotnega tlorisa z dvojnimi zidovi, obdaja pa ga še en zid, ki je predstavljal ograjo (glej Tonovcov grad. Naselbinski ostanki in interpretacija, pogl. 2.6, 3.4; pril. 5).

Tudi vodni zbiralnik je bil po tem, ko ni več služil prvotnemu namenu, uporabljen kot zatočišče v zgodnjem srednjem veku, na kar kaže močna žganinska plast in ostanki več posod v jugovzhodnem vogalu.

### 1.2.4 WATER CISTERN

On the highest eastern plateau of the settlement a water cistern (Fig. 1.6) of a rectangular ground plan was constructed. It was encircled by another wall which represents the fence (see Tonovcov grad. Settlement remains and interpretation, chapters 2.6, 3.4; insert 5).

A strong layer of charred remains and pottery fragments in the southeastern corner show that after it had been abandoned the water cistern was also used as a shelter in the Early Middle Ages.



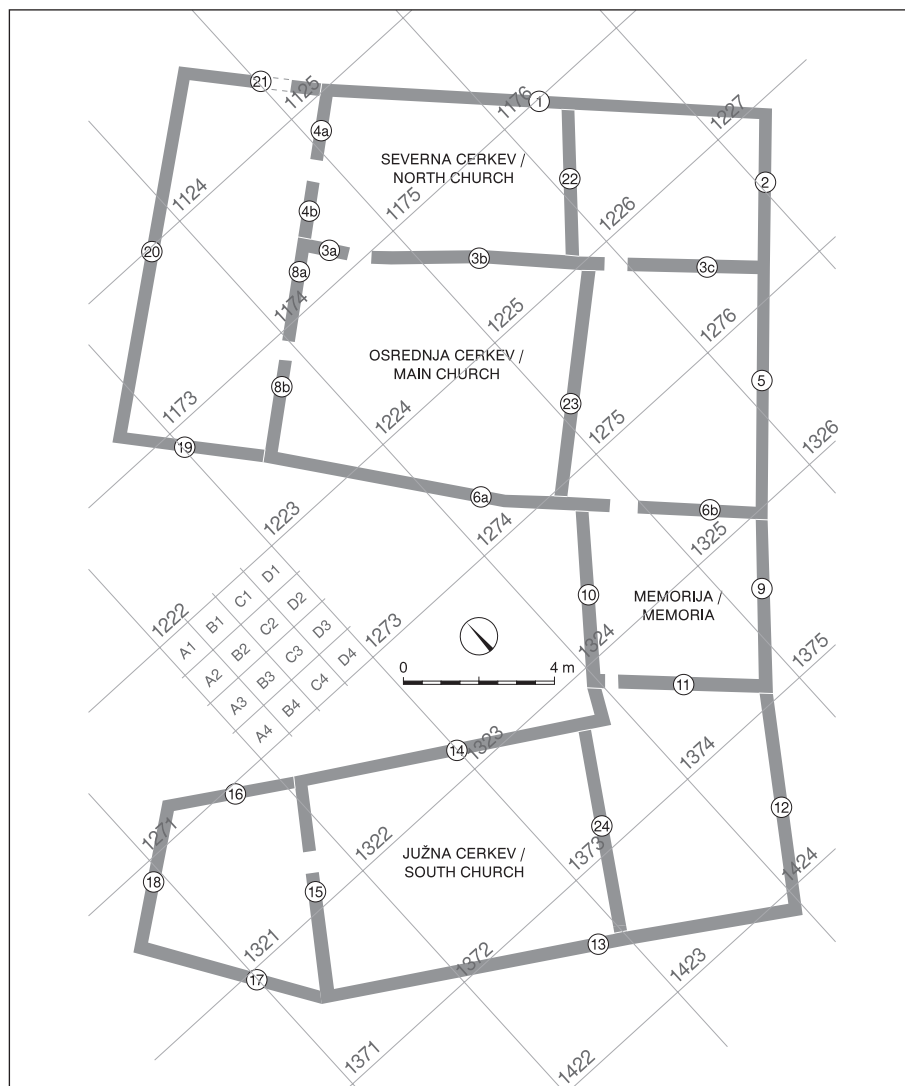

Sl. 1.4: Shematični tloris cerkva z mrežo kvadrantov. M. = 1:200 (Tonovcov grad. Naselbinski ostanki in interpretacija, sl. 2.47).  
 Fig. 1.4: Ground plan of churches with quadrant grid. Scale = 1:200 (Tonovcov grad. Settlement remains and interpretation, Fig. 2.47).

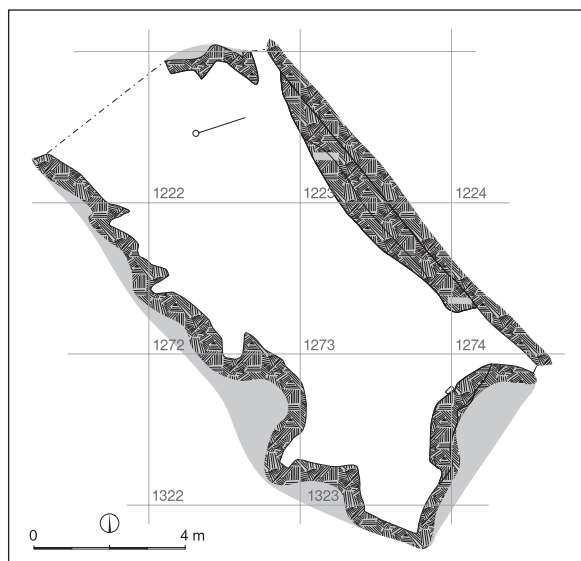
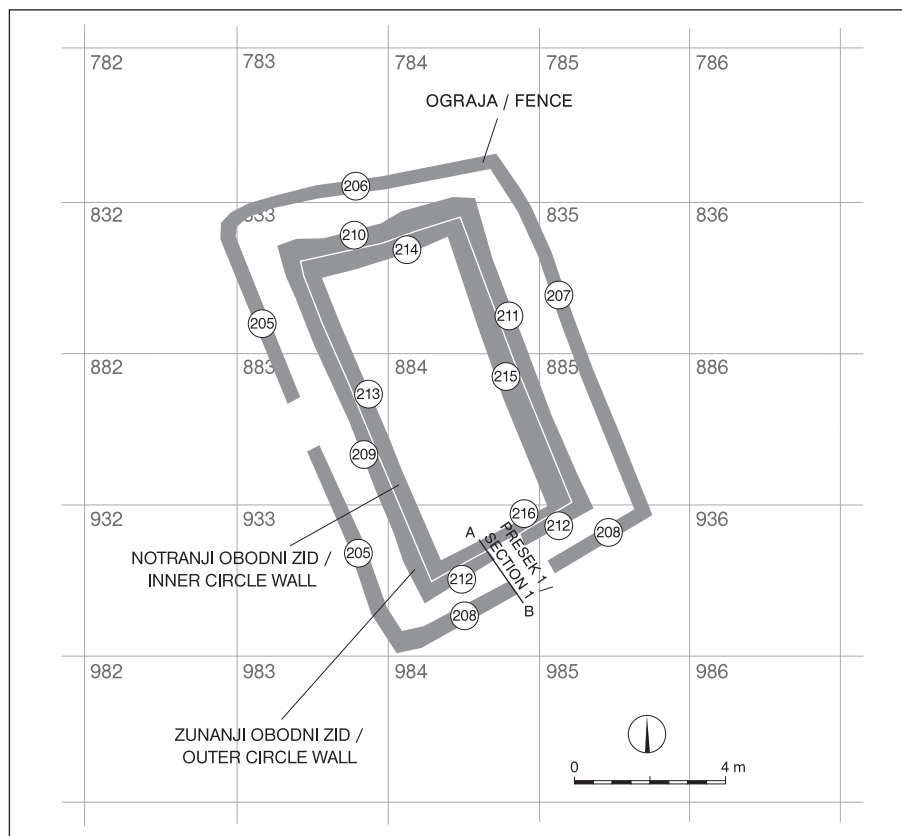

Fig. 1.5: Shematični tloris prostora med osrednjo in južno cerkvi. M. = 1:200 (po Tonovcov grad. Naselbinski ostanki in interpretacija, sl. 2.80).

Fig. 1.5: Ground plan of the space between the main and south church. Scale = 1:200 (after Tonovcov grad. Settlement remains and interpretation, Fig. 2.80).



Sl. 1.6: Shematični tloris cisterne. M. = 1:200 (Tonovcov grad. Naselbinski ostanki in interpretacija, sl. 2.97).

Fig. 1.6: Schematic ground plan of the cistern. Scale = 1:200 (Tonovcov grad. Settlement remains and interpretation, Fig. 2.97).

### 1.3 GROBOVI

V naselbini je bilo odkritih 22 struktur, interpretiranih kot grobovi, vendar sta bila dva prazna (grobova 2 in 14), v dveh pa so bile najdene samo živalske kosti (grobova 16 in 17). Človeških okostij je bilo torej 18, večina izmed njih je bila ohranjena v celoti, vendar so bile kosti v zelo slabem stanju.

Dva skeleta sta po pridatkih iz zgodnjega srednjega veka (grobova 18 in 21; konec 7. do začetka 9. stoletja), glede na lego pa v ta čas sodita tudi grobova 15 in 20, morda pa tudi grob 1a ob stavbi 1. Preostalih 14 skeletov je iz pozne antike, verjetno pripadajo drugi poznoantični fazi (konec 5., 6. st.). V seznamu so zajeti osnovni podatki o grobovih in njihove omembe v pričujoči knjigi ter v prvem zvezku (Tonovcov grad. Naselbinski ostanki in interpretacija). Antropološka analiza je predstavljena v poglavju 7.

Seznam je urejen v naslednjem vrstnem redu:

Št. groba: spol; lega; pridatki; omembe groba.  
Omembe groba v prvi knjigi (Tonovcov grad. Naselbinski ostanki in interpretacija).

### 1.3 GRAVES

The settlement revealed 22 structures that have been interpreted as graves. Two of them were empty (graves 2 and 14), and two contained only animal bones (graves 16 and 17). This means that there were 18 human skeletons, most of which were preserved in entirety, however the bones were in a very poor condition. Two skeletons were buried together with Early Medieval grave goods (graves 18 and 21; end of the 7<sup>th</sup> to the beginning of the 9<sup>th</sup> century); taking into account the location of graves 15 and 23 it seems that they could also belong into this period, as could grave 1a next to building 1. The remaining 14 skeletons were dated to Late Antiquity, most likely they originated to the Late Antiquity 2 phase (end of the 5<sup>th</sup> and 6<sup>th</sup> century). Elementary data on the graves as well as their mention in this volume and in the volume one (Tonovcov grad. Settlement remains and interpretation) are included in the list. Anthropological analysis is presented in chapter 7.

The graves are listed in the following order:

No. of the grave: sex; position; grave goods; quotations of the grave. Quotation of the grave in the

Grob 1a: moški; ob stavbi 1; brez pridakov; 280. Tonovcov grad. Naselbinski ostanki in interpretacija, sl. 2.2, 2.23; str. 86, **95**, 189.

Grob 1: moški; južna cerkev – prezbiterij; brez pridakov; 280–281; *sl. 7.4*; Tonovcov grad. Naselbinski ostanki in interpretacija, pril. 3–4; sl. 2.74, 2.75; str. 136, 205, **209**, 227, 234.

Grob 2: prazen grob – kenotaf; “memorija”. Tonovcov grad. Naselbinski ostanki in interpretacija, pril. 3, 4; sl. 2.71; str. **204**.

Grob 3: ženski; ob južni cerkvi; pridatki: *t. 51*: 4–7; pogl. 2.7.3; str. 69–71, *sl. 2.13, 2.14*; 281. Tonovcov grad. Naselbinski ostanki in interpretacija, pril. 3–4; sl. 2.76; str. 139, 207, **209**.

Grob 4: domnevno moški; v narteksu severne cerkve; brez pridakov; 281–282, *sl. 7.3–7.4*. Tonovcov grad. Naselbinski ostanki in interpretacija, pril. 4; sl. 2.69, 2.70; str. 132, 206, **209**.

Grob 5: otroški; v osrednji cerkvi; brez pridakov; 282. Tonovcov grad. Naselbinski ostanki in interpretacija, pril. 2, 4; sl. 2.67; str. 129, **209**.

Grob 6: otroški; za severno cerkvijo; brez pridakov; 282–283. Tonovcov grad. Naselbinski ostanki in interpretacija, pril. 2, 4; sl. 2.77; str. **140**.

Grob 7: otroški; za osrednjo cerkvijo; brez pridakov; 283. Tonovcov grad. Naselbinski ostanki in interpretacija, pril. 2, 4; sl. 2.77; str. **140**.

Grob 8: otroški; za osrednjo cerkvijo; brez pridakov; 283. Tonovcov grad. Naselbinski ostanki in interpretacija, pril. 2, 4; sl. 2.78; str. **141**.

Grob 9: otroški; za osrednjo cerkvijo; brez pridakov; 283. Tonovcov grad. Naselbinski ostanki in interpretacija, pril. 2, 4; sl. 2.78; str. **141**.

Grob 10: otroški; za osrednjo cerkvijo; brez pridakov; 283–284. Tonovcov grad. Naselbinski ostanki in interpretacija, pril. 2, 4; sl. 2.79; str. **141**.

Grob 11: otroški grob; za “memorijo”; brez pridakov; 284. Tonovcov grad. Naselbinski ostanki in interpretacija, pril. 4; sl. 2.79; str. **141–142**.

Grob 12: otroški grob; za “memorijo”; brez pridakov; 284. Tonovcov grad. Naselbinski ostanki in interpretacija, pril. 4; sl. 2.79; str. **141–142**.

first volume (Tonovcov grad. Settlement remains and interpretation).

Grave 1a: male; alongside the building 1; without grave goods; 280. Tonovcov grad. Settlement remains and interpretation, Figs. 2.2, 2.23; pgs. 86, **95**, 189.

Grave 1: male; south church – presbytery; without grave goods; 280; *Fig. 7.4*. Tonovcov grad. Settlement remains and interpretation, Inserts 3–4; Figs. 2.74, 2.75; pgs. 136, 205, **209**, 227, 234.

Grave 2: empty grave – cenotaph; ‘memoria’. Tonovcov grad. Settlement remains and interpretation, Inserts 3–4; *Fig. 2.71*; pg. **204**.

Grave 3: female; alongside the south church; grave goods: *Pl. 51*: 4–7; chapter. 2.7.3; pgs. 69–71; *Fig. 2.13, 2.14*; 281. Tonovcov grad. Settlement remains and interpretation, Inserts 3, 4; *Fig. 2.76*; pgs. 139, 207, **209**.

Grave 4: presumably male; in the narthex of the south church; without grave goods; 281–282; *Figs. 7.3–7.4*. Tonovcov grad. Settlement remains and interpretation, Insert 4; Figs. 2.69, 2.70; pgs. 132, 206, **209**.

Grave 5: child; in the main church; without grave goods; 283. Tonovcov grad. Settlement remains and interpretation, Inserts 2, 4; *Fig. 2.67*; pgs. 129, **209**.

Grave 6: infant; behind the north church; without grave goods; 283. Tonovcov grad. Settlement remains and interpretation, Inserts 2, 4; *Fig. 2.77*; pg. **140**.

Grave 7: infant; behind the north church; without grave goods; 283. Tonovcov grad. Settlement remains and interpretation, Inserts 2, 4; *Fig. 2.77*; pg. **140**.

Grave 8: infant; behind the north church; without grave goods; 283. Tonovcov grad. Settlement remains and interpretation, Inserts 2, 4; *Fig. 2.78*; pg. **141**.

Grave 9: child; behind the main church; without grave goods; 283–284. Tonovcov grad. Settlement remains and interpretation, Inserts 2, 4; *Fig. 2.78*; pg. **141**.

Grave 10: infant; behind the main church; without grave goods; 284. Tonovcov grad. Settlement remains and interpretation, Inserts 2, 4; *Fig. 2.79*; pg. **141**.

Grave 11: infant; behind the ‘memoria’; without grave goods; 284. Tonovcov grad. Settlement remains and interpretation, Insert 4; *Fig. 2.79*; pgs. **141–142**.

Grob 13: otroški; v narteksu severne cerkve; brez pridatkov; 284. Tonovcov grad. Naselbinski ostanki in interpretacija, pril 4; sl. 2.69; str. 132, 206, **209**.

Grob 14: domneven prazen grob; v prezbitერიju južne cerkve; Tonovcov grad. Naselbinski ostanki in interpretacija, pril. 3; sl. 2.75; str. 137, **205**.

Grob 15: ženski; ob stavbi 2; brez pridatkov; 284–285. Tonovcov grad. Naselbinski ostanki in interpretacija, sl. 2.44; str. **110**, 198, 199.

Grob 18: moški; ob stavbi 2; pridatki: *t. 44: 22–24, sl. 2.10: 2*; str. **65**, 66, 285. Tonovcov grad. Naselbinski ostanki in interpretacija, sl. 2.44; str. 71, 98, **110**, 198.

Grob 19: otroški; ob stavbi 2; brez pridatkov; 285. Tonovcov grad. Naselbinski ostanki in interpretacija, sl. 2.44; str. **110**, 199.

Grob 20: moški; ob stavbi 2; brez pridatkov; 285–286. Tonovcov grad. Naselbinski ostanki in interpretacija, sl. 2.44; str. **110**, 199.

Grob 21: ženski; med osrednjo in južno cerkvijo; pridatki: *t. 53: 10–12*; str. 67, **71**, 72, 286. Tonovcov grad. Naselbinski ostanki in interpretacija, sl. 2.95; str. 71, **153**, 210, 235.

Grave 12: child; behind the 'memoria'; without grave goods; 284. Tonovcov grad. Settlement remains and interpretation, Insert 4; Fig. 2.79; pgs. **141–142**.

Grave 13: child or adolescent; in the narthex of the north church; without grave goods; 284–285. Tonovcov grad. Settlement remains and interpretation, Insert 4; Fig. 2.69; pgs. 132, 206, **209**.

Grave 14: : presumably empty grave; in the presbytery of the south church. Tonovcov grad. Settlement remains and interpretation, Insert 3; Fig. 2.75; pgs. 137, **205**.

Grave 15: female; by the building 2; without grave goods; 285. Tonovcov grad. Settlement remains and interpretation, Fig. 2.44; pgs. **110**, 198, 199.

Grave 18: male; by the building 2; grave goods: *Pl. 44: 22–24, Fig. 2.10: 2*; pg. **65**, 66, 285–286. Tonovcov grad. Settlement remains and interpretation, Fig. 2.44; pgs. 71, 98, **110**, 198.

Grave 19: child; by the building 2; without grave goods; 286. Tonovcov grad. Settlement remains and interpretation, Fig. 2.44; pgs. **110**, 199.

Grave 20: male; by the building 2; without grave goods; 286. Tonovcov grad. Settlement remains and interpretation, Fig. 2.44; pgs. **110**, 199.

Grave 21: female; between the main and south church; grave goods: *t. 53: 10–12*; pgs. 67, **71**, 72, 287. Tonovcov grad. Settlement remains and interpretation, Fig. 2.95; pgs. 71, **153**, 210, 235.

## 1.4 LITERATURA / BIBLIOGRAPHY

Tonovcov grad. Naselbinski ostanki in interpretacija / Tonovcov grad. Settlement remains and interpretation = Ciglencečki, Modrijan, Milavec 2011.

CIGLENEČKI, S. 1990, K problemu datacije nastanka rimskodobnih višinskih utrd v jugovzhodnoalpskem prostoru. – *Arheološki vestnik* 41, 147–176.

CIGLENEČKI, S. 1999, Results and Problems in the Archaeology of the Late Antiquity in Slovenia / Izsledki in problemi poznoantične arheologije v Sloveniji. – *Arheološki vestnik* 50, 287–309.

CIGLENEČKI, S., Z. MODRIJAN in / and T. MILAVEC 2011, *Tonovcov grad. Naselbinski ostanki in interpretacija / Tonovcov grad. Settlement remains and interpretation*. – Opera Instituti Archaeologici 23.

## 2. KOVINSKE NAJDBE

### 2. METAL FINDS

Tina MILAVEC

Na Tonovcovem gradu je bilo odkrito veliko število drobnih najdb. V tem poglavju so predstavljeni železni, bronasti, srebrni in svinčeni predmeti, iz praktičnih razlogov pa so zajete tudi nekatere rogovinaste, kamnite in keramične najdbe.

Daleč največ drobnih najdb je bilo najdenih v izkopnem polju stavbe 1, v vseh ostalih stavbah jih je bilo bistveno manj. Časovno velika večina najdb pripada poznoantičnemu obdobju (med drugo polovico 4. in začetkom 7. st.). Prazgodovinske najdbe niso zajete v tem poglavju, temveč so obravnavane posebej (glej pogl. 6).

Predmeti so predstavljeni po stavbah (stavbe 1, 2, 3, cerkveni sklop in vodni zbiralnik). Zaradi preglednosti so v najbolj obsežnem podpoglavju (stavba 1) razdeljeni v skupine: fibule, nakit, pasne sponse in okovi, orožje, orodje, stavbno železo (ključi, zapahi, tečaji, žebli ipd.), toaletni pribor (pincete, glavniki) in odlomki bronastega posodja. Predmeti iz grobov, ki so vsebovali grobne pridatki, so obdelani v okviru stavb, kjer so bili grobovi najdeni (grobovi 3, 18, 21).

Z izjemo popolnoma brezobličnih kosov kovine so predstavljene vse najdbe, odkrite med izkopavanji in že pred njimi (pribl. 800 predmetov). Stratigrafski podatki so v besedilu navedeni le takrat, kadar pripomorejo k izpovednosti, za vse predmete pa so zbrani v katalogu. Prav tako so v katalogu zbrane navedbe dosedanjih objav nekaterih najdb.

#### 2.1 STAVBA 1

V izkopnem polju stavbe 1 so bili odkriti ostanki več faz poselitve. V prazgodovinsko in antično obdobje spada le nekaj plasti in drobnih najdb. Prva intenzivna poselitev sega v pozno antiko, delimo pa jo na prvo (PA 1; druga polovica 4.–začetek 5. st.) in drugo poznoantično fazo (PA 2; konec 5.–začetek 7. st.). Iz PA 1 je ohranjenih nekaj zidov in plasti, ki so pripadali eni ali več stavbam na tem mestu. V PA 2 so zgradili veliko stavbo 1 s prizidkom in vetrolovom. Večina drobnih najdb je iz te faze (Tonovcov grad. Naselbinski ostanki in interpretacija, sl. 3.15).

A large number of small finds was discovered at Tonovcov grad. This chapter presents the iron, bronze, silver and lead objects and for practical reasons also selected antler and pottery ones.

By far the most material was found in the excavation area of building 1, all the other structures revealed much less finds. Most of them belong to the Late Antique period (between second half of the 4<sup>th</sup> and the beginning of the 7<sup>th</sup> century). Prehistoric finds are not included here but evaluated separately (see chapter 6).

The small finds are presented within buildings where they were found (buildings 1, 2, 3, ecclesiastical complex, water cistern). In the subchapter on building 1 they are divided into groups for reasons of clarity (fibulae, jewellery, belt buckles and fittings, weaponry, tools, architectural fittings (keys, locks, hinges, nails, etc.), toilet instruments (combs and tweezers) and fragments of bronze vessels). Objects from graves which contained grave goods (graves 3, 18, 21) are included in the subchapters about structures where they were discovered.

With the exception of the completely amorphous pieces of metal all the discovered finds are presented here (ca. 800 objects). In the texts stratigraphic data is given only when especially meaningful, for all objects the data is included in the catalogue. Also, the information about previous publications of certain finds is listed in the catalogue.

#### 2.1 BUILDING 1

In the excavation area of building 1 remains of several settlement phases were discovered. Only few layers and small finds are assigned to the prehistoric and Early Antique periods. The first intensive settlement belongs to Late Antiquity, which is divided into the first (LA 1; second half of the 4<sup>th</sup> - beginning of the 5<sup>th</sup> century) and the second Late Antiquity phase (LA 2; end of the 5<sup>th</sup> - beginning of the 7<sup>th</sup> century). Some walls and layers belonging to one or several buildings in this location are preserved from LA 1. During LA 2 big building 1 with an outhouse and a wind shield was built. Most of the

Nekaj mlajših plasti kaže na zadrževanje ljudi v ruševinah stavbe 1 tudi v zgodnesrednjeveškem obdobju (glej Tonovcov grad. Naselbinski ostanki in interpretacija, pogl. 2.2, 2.3, 3.1).

### 2.1.1 FIBULE

#### FIBULE 1.–3. ST.

Tri bronaste fibule (*t. I: 1–3*) spadajo med močno profilirane fibule tipa Almgren 68, ki je bil zelo široko razprostranjen, izviral je iz Norika in Panonije in je datiran v drugo in tretjo četrtino 1. st. (Jobst 1975, 33; Gugl 1995, 12).

Pogoste so fibule široko razprostranjenega tipa Almgren 69 (*t. I: 4–10*), ki je datiran v konec 1. in 2. st. (Jobst 1975, 33).

Fibula (*t. I: 11*) spada v tip Almgren 84, ki je bil razprostranjen v Noriku, Reciji in ob limesu, datiran pa je v drugo polovico 2. st. (Jobst 1975, 40).

Z eno fibulo je zastopan tip Almgren 70/73c (*t. I: 12*), razprostranjen večinoma v Noriku in Panoniji in datiran med drugo polovico 1. in prvo polovico 2. st. (Gugl 1995, 15–16).

Pet odlomkov močno profiliranih fibul je natančneje nedoločljivih (*t. I: 13–17*).

Močno profilirana fibula s plosko trapezasto nogo (*t. I: 18*, detektorska najdba) spada v tip Jobst 4F. Ta tip fibul je bil v Evropi zelo razširjen, časovno ga umeščamo v drugo polovico 1. do tretje četrtine 2. st. (Jobst 1975, 140).

Razen fibule (*t. I: 3*), ki je bila najdena v plasti faze PA 1, so močno profilirane fibule (*t. I: 1–2,4–18*) ležale v plasteh faze PA 2 (*t. I: 7–8,10–13*), ruševini (*t. I: 9*) in premešani plasti (*t. I: 5–6,14–15*).

Med noriško-panonske fibule spada primerek tipa Almgren 236 (*t. I: 19*), ki je ležal v plasti faze PA 1. Datiran je v 1.–2. st. (Garbsch 1965, 26–43), zaradi slabe ohranjenosti fibule pa podtipa ne moremo določiti.

Z niellom okrašena fibula z živalsko glavico (*t. I: 20*) je ležala v plasti zunanje hodne površine stavbe 1. Spada v skupino 5, tip 15 po E. Riha, to so z niellom okrašene fibule s šarnirjem. Obstaja veliko različic tega tipa, vendar niso razvrščene v podtipe. Te fibule so bile najpogosteje v uporabi v Britaniji, Galiji, Švici in srednjem Porenju, datirane pa so v drugo polovico 1. in na začetek 2. st. (Riha 1994, 133–134).

Fibule iz 3. stoletja so zastopane z dvema primerkoma (*t. 2: 5–6*) tipa Jobst 13D, ki sta ležala v plasti faze PA 2. Za ta podtip, ki je datiran v čas med drugo četrtino 2. in prvo polovico 3. st., je značilna polkrožna glava, okrašena z motivom volčjih zob (Jobst 1975, 24, 165–168). Tonovski fibuli imata ena (*t. 2: 6*) enojno vrsto motiva, druga (*t. 2: 5*) dvojno, od klasičnega tipa se razlikujeta le po tem, da imata fasetiran lok, kar je sicer značilnost nekaterih primerkov malce kasnejšega podtipa 13E.

small finds originate from this phase (Tonovcov grad. Settlement remains and interpretation, Fig. 3.15).

A few later layers indicate that people have dwelt in the ruins of building 1 also in the Early Medieval period (see Tonovcov grad. Settlement remains and interpretation, chapters 2.2, 2.3, 3.1).

### 2.1.1 FIBULAE

#### FIBULAE OF THE 1<sup>ST</sup> - 3<sup>RD</sup> CENTURY

Three bronze fibulae (*Pl. I: 1–3*) belong among the strongly profiled fibulae of type Almgren 68, which is very widely distributed. It originates from Noricum and Pannonia and is dated to the second and third quarter of the 1<sup>st</sup> century (Jobst 1975, 33; Gugl 1995, 12).

Fibulae of the widely distributed type Almgren 69 (*Pl. I: 4–10*) which is dated to the end of the 1<sup>st</sup> and the 2<sup>nd</sup> century (Jobst 1975, 33) are also frequent.

A fibula (*Pl. I: 11*) belongs to type Almgren 84 which is distributed along Noricum, Raetia, and the Danubian limes. It is dated to the second half of the 2<sup>nd</sup> century (Jobst 1975, 40).

One fibula represents type Almgren 70/73c (*Pl. I: 12*) which is distributed mostly along Noricum and Pannonia and is dated between the second half of the 1<sup>st</sup> and the first half of the 2<sup>nd</sup> century (Gugl 1995, 15–16).

Five fragments of strongly profiled fibulae are impossible to classify more precisely (*Pl. I: 13–17*).

A strongly profiled fibula with a flat trapezoid foot (*Pl. I: 18*, metal detector find) belongs to type Jobst 4F. This fibula type is widely distributed in Europe and belongs to the time between the second half of the 1<sup>st</sup> and the third quarter of the 2<sup>nd</sup> century (Jobst 1975, 140).

Except for a fibula (*Pl. I: 3*) which was found in a layer of phase LA 1, strongly profiled fibulae (*Pl. I: 1–2,4–18*) were lying in layers of phase LA 2 (*Pl. I: 7–8,10–13*), the destruction layer (*Pl. I: 9*), and a mixed layer (*Pl. I: 5–6,14–15*).

An example of type Almgren 236 (*Pl. I: 19*) which was found in a layer of phase LA 1 belongs among Norico-Pannonian fibulae. It is dated to the 1<sup>st</sup>-2<sup>nd</sup> century (Garbsch 1965, 26–43) but cannot be attributed a subtype due to poor preservation of the fibula.

Niello-decorated fibula with an animal head (*Pl. I: 20*) was lying in the outer walking surface of building 1. It belongs to group 5 of type 15 according to E. Riha, i.e. niello-decorated fibulae with a hinge. There are many variants of this type which is in general not subdivided into variants. These fibulae most frequently appear in Britain, Gaul, Switzerland, and central Rhine region. They are dated to the second half of the 1<sup>st</sup> and the beginning of the 2<sup>nd</sup> century (Riha 1994, 133–134).

### OBROČASTE FIBULE Z NAVZNOTER ZAVITIMI KONCI

Pri stavbi 1 so bile najdene bronasta obročasta fibula s trakastim presekom obroča (*t. 2: 1*) in tri železne, od katerih ima ena ima trakast (*t. 2: 2*), dve pa rombast preseki obroča (*t. 2: 3–4*). Ležale so v plasteh faze PA 2 (*t. 3: 1–3*) in zgodnjerednjeveški plasti (*t. 3: 4*).

Obročaste fibule z navznoter zavitim konci spadajo v varianto A po J. Garbschu. W. Jobst jih je uvrstil v svoj tip 36 A, E. Riha pa v skupino 8.2.4. Datirane so v 3. in 4. stoletje, znane iz srednje in vzhodne Evrope, in to v bronasti ter železni različici s trakastim ali rombastim presekom obroča (Garbsch 1965, 125; Jobst 1975, 217; Riha 1979, 209).

### FIBULE S ČEBULASTIMI GUMBI

Najdeni so bili trije odlomki fibul s čebulastimi gumbi (*t. 2: 7–9*). Čebulica (*t. 2: 8*) je bila najdena v plasti faze PA 2, noga (*t. 2: 7*) je ključna najdba, druga noga (*t. 2: 9*) pa je ležala v plasti zunanje hodne površine faze PA 2. Čebulica (*t. 2: 8*) spada najverjetneje k tipu Keller 4 oz. enemu od podtipov Pröttel 3/4, noga (*t. 2: 7*) pa k tipu 3/4 D, ki ga je E. Keller datiral med 350–380 (Keller 1971, 35), P. Pröttel pa je to datacijo razširil na čas med 330–410 (Pröttel 1988, 363, 372). Noga (*t. 2: 9*) je preslabo ohranjena za določitev.

### FIBULE TIP A HRUŠICA

Najdenih je bilo pet fibul tipa Hrušica (*t. 2: 10–14*). Dva primerka sta neokrašena (*t. 2: 12–13*), prvi je bil najden v plasti faze PA 2, za drugega pa ni najdiščnih podatkov. Fibula (*t. 2: 10*) ima lok ob straneh okrašen z vrezi ter po sredini s tremi vtisnjenimi krožci s piko. S tremi krožci s piko je okrašena tudi glava fibule. Ta fibula je ležala v plasti faze PA 1, po okrasu pa ji lahko najdemo primerjave v fibulah iz Strassolda in Percota pri Vidmu (Buora, Candussio, Pröttel 1990, sl. 6: 6; 8: 5) ter Campi Neri in Sanzena (Höck 2003, sl. 44: 4,6). Fibula (*t. 2: 11*) je okrašena z dvema črtama in tremi krožci s piko na loku ter tremi krožci na glavi, z dvema vrezoma in dvema krožcema na eni in petimi krožci na drugi strani je okrašena tudi noga. Ta fibula je ležala v plasti faze PA 2, najbližjo primerjavo pa ji lahko najdemo v fibuli iz Obermauern (Höck 2003, sl. 44: 1).

Fibula (*t. 2: 14*) je bila najdena z iskalcem kovin.

K objavljenim najdbam fibul tega tipa iz Slovenije (Buora, Candussio, Pröttel 1990, kat. 73–76) lahko dodamo še fragmentiran primerek s Krvavice pri Vranskem (Krempuš 2000, sl. 4: 27) in del fibule s Selc nad Zatoľminom (Mlinar 2010, 254–255, sl. 2; Cunja, Mlinar 2010, 126, kat. 195).

Fibulae of the 3<sup>rd</sup> century are represented by two examples (*Pl. 2: 5–6*) of type Jobst 13D and were found in a layer of phase LA 2. For this subtype which is dated to the time between the second quarter of the 2<sup>nd</sup> and the first half of the 3<sup>rd</sup> century a semicircular head ornamented by a motif of wolf's teeth (Jobst 1975, 24, 165–168) is typical. One (*Pl. 2: 6*) of the two fibulae from Tonovcov grad has a single line of the motif while the other (*Pl. 2: 5*) has a double line. They differ from the classical type only in that they have a faceted bow, which is generally a characteristic of certain examples of a somewhat later subtype 13E.

### PENANNULAR FIBULAE WITH ROLLED ENDS

Near building 1 one bronze penannular fibula with a strap-shaped cross section of the ring (*Pl. 2: 1*) and three iron ones, of which one has a strap shaped (*Pl. 2: 2*) and the other two have a rhombic cross section of the ring (*Pl. 2: 3–4*), were found. They were found in layers of phase LA 2 (*Pl. 3: 1–3*) and in the Early Medieval layer (*Pl. 3: 4*).

Penannular fibulae with rolled ends belong to variant A according to J. Garbsch. W. Jobst assigns them to his type 36 A and E. Riha to group 8.2.4. They are dated to the 3<sup>rd</sup> and 4<sup>th</sup> century and appear in central and eastern Europe in the bronze and iron versions with a strap-shaped or rhombic cross section of the ring (Garbsch 1965, 125; Jobst 1975, 217; Riha 1979, 209).

### ROMAN CROSSBOW FIBULAE

Three fragments of Roman crossbow fibulae (*Pl. 2: 7–9*) were found. The onion-shaped knob (*Pl. 2: 8*) was found in a layer of phase LA 2, a foot (*Pl. 2: 7*) is a chance find, while a foot (*Pl. 2: 9*) was lying on the outer walking surface of phase LA 2. The onion-shaped knob (*Pl. 2: 8*) most probably belongs to type Keller 4 or to one of the subtypes of Pröttel 3/4 and a foot (*Pl. 2: 7*) to type 3/4 D, which E. Keller dated between 350 and 380 (Keller 1971, 35) and P. Pröttel extended this dating to the time between 330 and 410 (Pröttel 1988, 363, 372). A foot (*Pl. 2: 9*) is too poorly preserved to be classified precisely.

### FIBULAE OF HRUŠICA TYPE

Five Hrušica type fibulae (*Pl. 2: 10–14*) were found. Two examples are undecorated (*Pl. 2: 12–13*), the first was found in a layer of phase LA 2, while for the other there are no find spot data. A fibula (*Pl. 2: 10*) has a bow which is on the sides decorated by incisions and in the middle by three impressed ring-and-dots. Three ring-and-dots also decorate the head of this fibula. It lay in a layer of phase LA 1. Considering the decoration it can be paralleled with

Tip Hrušica se pojavlja v glavnem na severnoital-skem področju, v Furlaniji, nekaj primerkov pa sega še do donavskega limesa (Buora, Candussio, Pröttel 1990, 616–617). A. Höck je dopolnil karto razprostranjenosti teh fibul in ugotovil, da se kronološko večinoma uvrščajo v čas med zgodnjim 4. in zgodnjim 5. stoletjem, z močnim poudarkom na drugi polovici 4. stoletja. Poskusil jih je razvrstiti glede na razmerje med dolžino in višino loka, tako je dobil podtype Hrušica a (vrednosti med 2,3/2,42–3,29), Hrušica b (vrednosti 1,7–2,3/2,42) in Hrušica a/b (vrednosti med 1,7–2,3). Ti podtipi se delijo dalje glede na to, ali imajo okras ali ne, na varianti 1 (z okrasom) in 2 (brez okrasa). Delitev za zdaj ni dala posebnih rezultatov (Höck 2003, 43–48).

### SAMOSTRELNE FIBULE

Obravnavamo samostrelne fibule dveh skupin. Prvo predstavljajo fibule s trdnim nosilcem igle<sup>1</sup> pozne sheme z različicami Invillino, Lauriacum in Siscia. Zanj sta značilna dolga noga s trdnim nosilcem igle in kratek gladek lok. Druga skupina so samostrelne fibule s trdnim nosilcem igle in gumbom na loku<sup>2</sup> z različico Gurina. Obe skupini sta datirani v drugo polovico 5. in prvo polovico 6. st. Najdene v Sloveniji so bile pred kratkim predstavljene v samostojnem članku, v katerem smo se osredotočili na njihovo pojavljanje v jugovzhodnih Alpah. Različice iz tega prostora najverjetneje pripadajo staroselskemu prebivalstvu (Milavec 2009).<sup>3</sup>

Tovrstne fibule, predvsem tip Invillino, so bile pogoste tudi na območju Bosne in Dalmacije (Busuladžić 2010). Žal jih je veliko objavljenih brez konteksta, tako da ne pripomorejo k njihovemu boljšemu razumevanju. Objava A. Busuladžića (2010), v kateri se je avtor uspešno izognil prej pogostim zamenjavam med sicer slabo ohranjenimi in težko razpoznavnimi fibulami, kljub temu jasno kaže, da je prav ta prostor (predvsem Hrvaška, Bosna in Srbija) stičišče jugovzhodnoalpskih in bizantinskih tipov samostrelnih fibul, za katere je značilna nazaj zavita noga.

### Samostrelne fibule s trdnim nosilcem igle pozne sheme

#### Tip Invillino

Zanj so značilni kratka peresovina, polkrožen kratek lok in dolga noga s trdnim nosilcem igle (Schul-

fibulae from Strassold and Percoto near Udine (Buora, Candussio, Pröttel 1990, Figs. 6: 6; 8: 5), from Campi Neri and Sanzeno (Höck 2003, Fig. 44: 4,6). A fibula (*Pl.* 2: 11) is decorated by two lines and three ring-and-dots on the bow and by three rings on the head, the foot is also decorated by two incisions and two rings on one side and five rings on the other. The foot was found in a layer of phase LA 2, the closest analogy for it can be found in the fibula from Obermauern (Höck 2003, Fig. 44: 1).

A fibula (*Pl.* 2: 14) was found by a metal detector.

Another fragmented example from Krvavica near Vransko (Krempeš 2000, Fig. 4: 27) and a part of a fibula from Selce above Zatoľmin (Mlinar 2010, 254-255, Fig. 2; Cunja, Mlinar 2010, 126, cat. no. 195) can be added to the published finds of fibulae of this type in Slovenia (Buora, Candussio, Pröttel 1990, cat. nos. 73-76).

Type Hrušica mainly appears in the northern Italic area and in Friuli, some examples extend to the Danubian limes (Buora, Candussio, Pröttel 1990, 616-617). A. Höck supplemented the distribution chart and discovered that chronologically they mostly belong to the time between the early 4<sup>th</sup> and the early 5<sup>th</sup> century, with strong emphasis on the second half of the 4<sup>th</sup> century. He tried to classify fibulae according to the ratio between the length and height of the bow, thus getting subtypes Hrušica a (values between 2.3/2.42 and 3.29), Hrušica b (values 1.7-2.3/2.42), and Hrušica a/b (values between 1.7 and 2.3). These subtypes are divided further according to whether they have an ornament or not to variants 1 (with ornament) and 2 (without ornament). The division has so far not yielded any particular results (Höck 2003, 43-48).

### CROSSBOW FIBULAE

Here we discuss crossbow fibulae of two groups. The first group is represented by crossbow fibulae with firm catch plate<sup>1</sup> of the late scheme with variants Invillino, Lauriacum, and Siscia. A long foot with firm catch plate and a short, smooth bow are characteristic of them. The second group are crossbow knob bow fibulae<sup>2</sup> (also with a firm catch plate) with the variant Gurina. Both groups are dated to the second half of the 5<sup>th</sup> and the first half of the 6<sup>th</sup> century. Those found in Slovenia were recently presented in an independent article where we focused on their appearance in the Southeastern Alps. Variants from this territory most probably belong to the Romanized autochthonous inhabitants (Milavec 2009).<sup>3</sup>

<sup>1</sup> Nem. Armbrustfibel.

<sup>2</sup> Nem. Bügelknopffibel.

<sup>3</sup> V članku smo obravnavali tudi v Sloveniji redke najdbe balkanskih samostrelnih fibul z nazaj zavito nogo. Pri tem smo med domnevne fibule 6. st. šteli tudi dva odlomka, ki dejansko pripadata prazgodovinskim tipom (Milavec 2009, t. 2: 10,12); prim. pogl. 6, sl. 6.2: 17–18.

<sup>1</sup> German: Armbrustfibel.

<sup>2</sup> German: Bügelknopffibel.

<sup>3</sup> The article also discusses finds of Balkan crossbow fibulae with an inverted foot rare in Slovenia. Two fragments which actually belong to prehistoric types (Milavec 2009, Pl. 2: 10,12) were here also assigned among the supposed fibulae of the 6<sup>th</sup> century; cf. chapter 6, Fig. 6.2: 17.



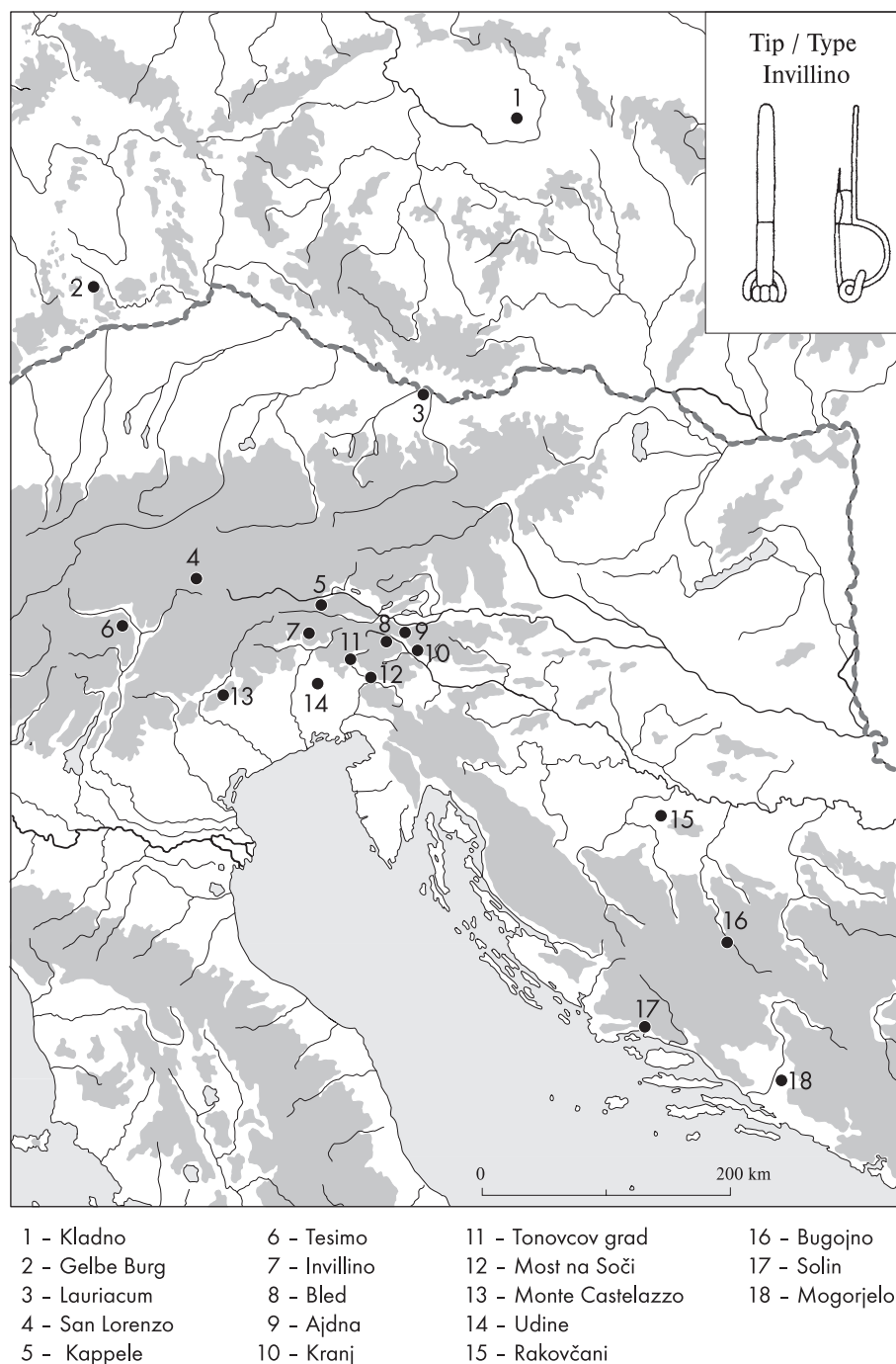

Sl. 2.1: Karta razprostranjenosti samostrelnih fibul tipa Invillino (po Milavec 2009, sl. 4).

Fig. 2.1: Distribution of crossbow fibulae type Invillino (after Milavec 2009, Fig. 4).

ze-Dörrlamm 1986, 639–641; Milavec 2009, 226–227). Na Tonovcovem gradu so bile najdene tri fibule tega tipa (*t. 2:* 15–16; 3: 2) v plasteh faze PA 2 in ruševini. En primerek (*t. 2:* 15) ima nenavadno dolg nosilec igle, obrnjen na drugo stran noge kot pri večini fibul. Fibula (*t. 2:* 16) glede na proporce in obliko noge verjetno pripada temu tipu, vendar ima rahlo privihan zaključek noge, tako da bi lahko spadala tudi k tipu Lauriacum,

Such fibulae, especially type Invillino, frequently appear also in the area of Bosnia and Dalmatia (Busulažić 2010). Unfortunately, many are published without their contexts and thus do not contribute to a better understanding of this type of fibulae. The publication of A. Busulažić (2010), where there no longer occur previously very frequent exchanges between poorly preserved and hardly recognisable fibulae, nevertheless

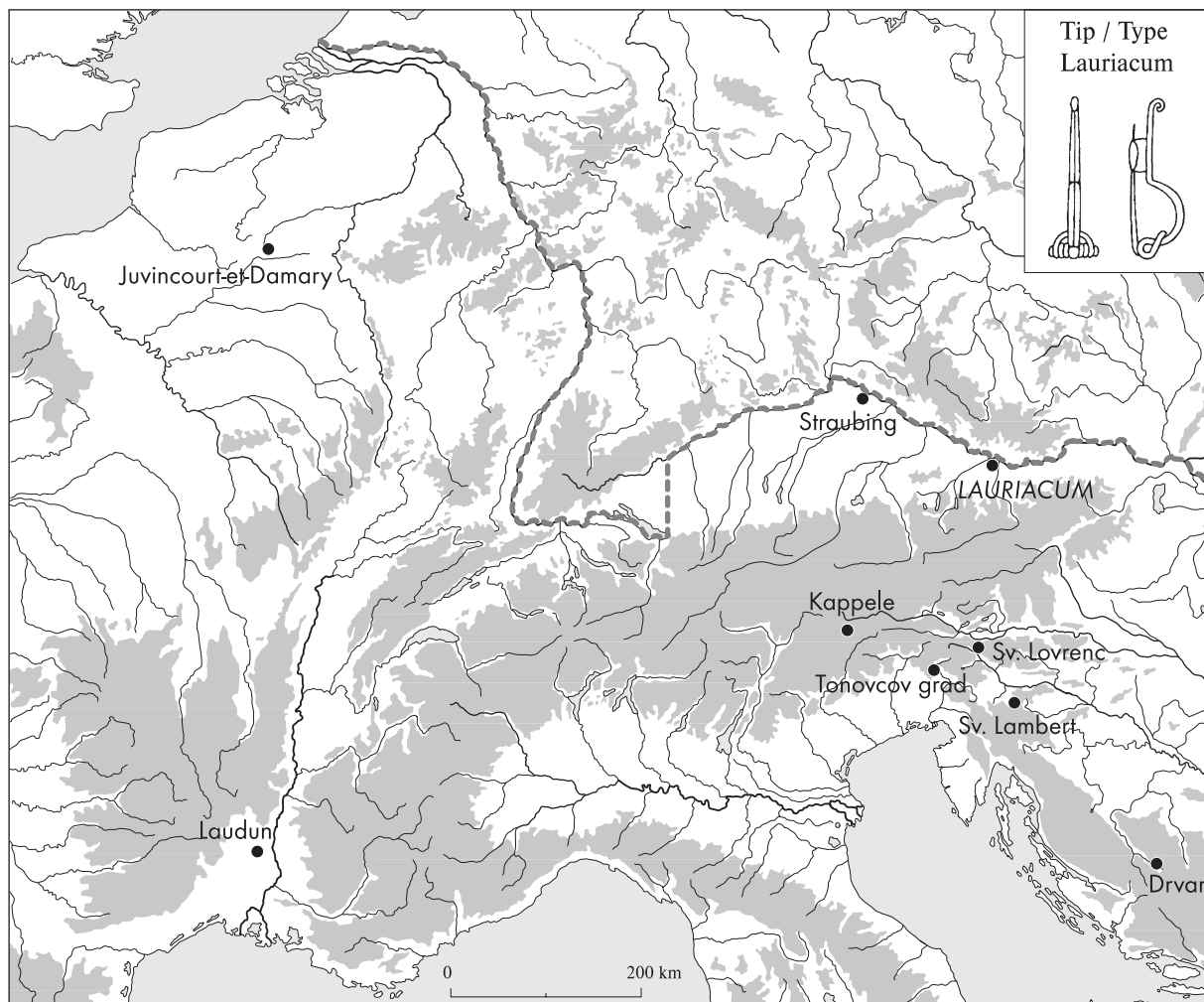

Sl. 2.2: Karta razprostranjenosti samostrelnih fibul tipa Lauriacum (po Milavec 2009, sl. 7).

Fig. 2.2: Distribution of crossbow fibulae type Lauriacum (after Milavec 2009, Fig. 7).

za katerega je značilen uvit, zapognjen ali gumbast zaključek noge.

K fibulam, predstavljenim v članku (Milavec 2009), lahko dodamo še pred kratkim objavljeno fibulo tipa Invillino iz naselbine na Mostu na Soči (Cunja, Mlinar 2010, 129, kat. 210; brez najdiščnih podatkov). Najdeni novci kažejo na trajanje te naselbine vsaj do prve polovice 5. st. (Kos 1988, 23–33; Kos, Šemrov 1995, 19–20), fibula pa morda še do konca 5. ali celo v 6. st.

Poleg jugovzhodnoalpskih primerkov (Milavec 2009) je bilo nekaj fibul tega tipa najdenih tudi na zahodnem Balkanu, v Mogoerjelu in Rakovčanih (Busulažić 2010, kat. 339, 340, 342, 343). Na Gospinem otoku v Solinu je bila fibula tipa Invillino kot edina najdba odkrita pri desnem boku skeleta v grobu, ki je bil sestavljen iz neobdelanih kamnitih plošč in tegul. Avtor prispevka skupino treh grobov, od katerih sta dva povsem brez pridatkov, tretji pa vsebuje omenjeno fibulo, na podlagi grobne arhitekture in dejstva, da je bil pokojnik iz groba 1 obglavljen, pripisuje Germanom (Vzhodnim Gotom;

clearly shows that this exact place (mostly Croatia, Bosnia, and Serbia) is the juncture of southeastern Alpine types and the Byzantine types of crossbow fibulae, for which an inverted foot is characteristic.

#### Crossbow fibulae with firm catch plate of the late scheme

##### Type Invillino

For this type a short spring, a semicircular short bow, and a long foot with firm catch plate are characteristic (Schulze-Dörrlamm 1986, 639–641; Milavec 2009, 226–227). At Tonovcov grad three fibulae of this type were found (*Pls.* 2: 15–16; 3: 2) in layers of phase LA 2 and in the destruction layer. One example (*Pl.* 2: 15) has an unusually long catch plate on the other side of the foot than with most fibulae. A fibula (*Pl.* 2: 16), considering the proportions and shape of the

Katić 1996–1997, sl. 6). Prav zaradi grobne arhitekture iz plošč in tegul ter pomanjkanja pridakov se vendarle zdi verjetneje, da gre za staroselce.

Dopolnjena karta razprostranjenosti (sl. 2.1) še vedno poudarja jugovzhodnoalpski značaj tega tipa samostrelnih fibul.<sup>4</sup>

#### Tip Lauriacum

Od tipa Invillino se razlikuje le v tem, da ima uvit, zapognjen ali gumbast zaključek noge (Schulze-Dörrlamm 1986, 642–643; Milavec 2009, 228). K temu tipu lahko zagotovo štejemo fibulo z območja stavbe 1 (t. 3: 3), najdeno v premešani plasti.

K že obravnavanim (Milavec 2009, 228) lahko dodamo še posamezno najdbo iz Drvarja pri Bosanskem Petrovcu (Busuladžić 2010, kat. 338) ter fibulo iz groba 474 v Straubingu (Geisler 1998, t. 170: gr. 474: 1)<sup>5</sup>. Grob iz Straubinga vsebuje veliko črno jagodo z belimi linijami (Geisler 1998, t. 170: gr. 474: 9), ki je datirana v konec 5. in začetek 6. stoletja (Losert, Pleterški 2003, 255–257, sl. 55: 2). Tako ta grob kot ena redkih zaključenih celot potrdjuje datacijo obravnavanih fibul v konec 5. in začetek 6. st.

Težišče njihove razširjenosti je jugovzhodnoalpski prostor (sl. 2.2).

#### Tip Siscia

Zanj so značilni kratka peresovina, kratek lok in dolga stožčasta noga (Schulze-Dörrlamm 1986, 635; Milavec 2009, 228–229).

Dve železni fibuli (t. 2: 17; 3: 1) sta ležali v ruševinskih plasteh faze PA 2. Pri drugi fibuli je noga sicer slabo ohranjena, vendar dovolj, da jo uvrstimo v ta tip.

Tudi pri tem tipu fibul se je izkazalo, da je središče njegove razprostranjenosti v jugovzhodnih Alpah (Milavec 2009, sl. 8).

### Samostrelne fibule z gumbom na loku

#### Tip Gurina

Za ta tip so značilni kratka peresovina, kratek polkrožen lok z zanko za os peresovine in dolga noga z gumbom in trdnim nosilcem igle. Gumbi na nogi, na osi peresovine in na loku so lahko zelo različno oblikovani. Vse fibule so bronaste z železno peresovino. Razširjene so bile večinoma na jugovzhodnoalpskem območju,

<sup>4</sup> Na karti (Milavec 2009, sl. 4) je fibula tipa Invillino z najdišča Brozany. V resnici izvira iz Kladna, na kar me je prijazno opozoril E. Droberjahr.

<sup>5</sup> Na ta grob (in druge s samostrelnimi fibulami) iz Straubinga me je prijazno opozoril H. Geisler.

foot, probably belongs to this type. But it has a slightly rolled foot ending thus it could also belong to type Lauriacum, for which a rolled, bent or knobbed foot ending is typical.

To fibulae presented in the article (Milavec 2009) we can add a recently published fibula of type Invillino from the settlement at Most na Soči (Cunja, Mlinar 2010, 129, cat. no. 210; without findspot data). Coins indicate that the settlement lasted at least until the first half of the 5<sup>th</sup> century (Kos 1988, 23–33; Kos, Šemrov 1995, 19–20), and this fibula possibly also until the end of the 5<sup>th</sup> or even the 6<sup>th</sup> century.

Besides southeastern Alpine fibulae (Milavec 2009) some fibulae of this type were also found in the western Balkans, in Mogorjelo and Rakovčani (Busuladžić 2010, cat. nos. 339, 340, 342, 343). At Gospiin Otok in Solin, one fibula of type Invillino was found as the only find along the right hip of a skeleton in a grave assembled of unworked stone plates and tegulae. The author of the article, on the basis of the grave architecture and the fact that the deceased from grave 1 was decapitated, assigns the group of three graves (from which two are completely without grave goods and the third includes the above-mentioned fibula), to Germanic people (Eastern Goths; Katić 1996–1997, Fig. 6). On the basis of the grave architecture made of plates and tegulae and the lack of grave goods it seems more probable that we are dealing with Romanized autochthonous people.

The supplemented distribution map (Fig. 2.1) still emphasizes the southeastern Alpine character of this type of crossbow fibulae.<sup>4</sup>

#### Type Lauriacum

This type differs from type Invillino in that it has a rolled, bent or knobbed foot ending (Schulze-Dörrlamm 1986, 642–643; Milavec 2009, 228). One fibula from the area of building 1 (Pl. 3: 3) found in a mixed layer can certainly be assigned to this type.

To the above-discussed (Milavec 2009, 228) an individual find from Drvar near Bosanski Petrovac (Busuladžić 2010, cat. no. 338) and a fibula from grave 474 in Straubing (Geisler 1998, Pl. 170: gr. 474: 1)<sup>5</sup> can be added. The grave from Straubing contains a big black bead with white lines (Geisler 1998, Pl. 170: gr. 474: 9) which is dated to the end of the 5<sup>th</sup> and the beginning of the 6<sup>th</sup> century (Losert, Pleterški 2003, 255–257, Fig. 55: 2). Thus this grave, as one of the rare closed contexts,

<sup>4</sup> On distribution map (Milavec 2009, Fig. 4) a fibula of type Invillino from the site Brozany appears. It actually originates from Kladno, to which my attention was kindly brought by E. Droberjahr.

<sup>5</sup> My attention was kindly drawn to this grave (and other with crossbow fibulae) from Straubing by H. Geisler.

štirje primerki pa so bili najdeni v Španiji. Datirane so v drugo polovico 5. in v začetek 6. stoletja (Schulze-Dörrlamm 1986, 663–668).

V ta tip spadajo štirje primerki z območja stavbe 1 (*t. 3: 7–10*). Fibula (*t. 3: 10*) je bila najdena v plasti hodne površine v stavbi 1, druga (*t. 3: 9*) v plasti faze PA 2, za ostali dve pa ni podatka.

Kot prejšnji tipi je tudi tip Gurina zgoščen na jugovzhodnoalpskem območju (Milavec 2009, sl. 11), pojavlja pa se tudi na Pirenejskem polotoku.

### Neopredeljene fibule

Najdenih je bilo še več fragmentov fibul s trdnim nosilcem igle (*t. 3: 4–6,14*), vendar so preslabo ohranjeni, da bi jih lahko razvrstili v tipe, še posebej zato, ker se nekateri tipi med seboj tako malo razlikujejo. Ležali so v plasteh faze PA 2 in v premešani plasti.

Del železne peresovine in loka fibule s Tonovcovega gradu pripada samostrelni fibuli z gumbom na loku (*t. 3: 11*), ki pa se loči od ostalih tovrstnih fibul, ki imajo na loku zanko za os peresovine. Pri tonovski fibuli os peresovine drži lok, ki sega okrog osi od spodaj navzven in navzgor, kar je sicer značilnost samostrelnih fibul tipov Siscia, Passau, Invillino in nekaterih primerkov tipov Praga in Viminacium. Ti tipi se pojavljajo v Meziji I in II, Daciji, Dalmaciji in Noriku (Schulze-Dörrlamm 1986, 675). Zaradi slabe ohranjenosti fibule s Tonovcovega gradu ne moremo uvrstiti v noben navedeni tip.

### Sklep

Samostrelne fibule s trdnim nosilcem igle so se razvile pri barbarških in germanskih ljudstvih v 2.–3. st. (Ioniță 1998, 232–233; Schulze 1977, 167–168), samostrelne fibule z gumbom na loku pa v 4. in 5. st. (Schulze-Dörrlamm 1986, 593, 677; Voss 1998, 276).

Konec 5. in na začetku 6. st. so bile tovrstne fibule razširjene na prostoru rimskega imperija le na omejenih območjih. Samostrelne fibule s trdnim nosilcem igle tipov Estagel in Duratón so bile razširjene v Španiji in jugozahodni Franciji in so pripisane Zahodnim Gotom (Schulze-Dörrlamm 1986, 692–694, sl. 108). Drugo področje razširjenosti samostrelnih fibul s trdnim nosilcem igle so jugovzhodne Alpe. Tu se pojavljajo različice tipov Invillino, Lauriacum in Siscia, ki jih srečamo na Tonovcovem gradu (*sl. 2.1, 2.2; t. 2: 15–17; 3: 1–3*), in Passau, ki ga na Tonovcovem gradu ni (Milavec 2009, 226–229). Od samostrelnih fibul z gumbom na loku se v jugovzhodnih Alpah pojavljajo tipi Gurina, ki ga najdemo tudi na Tonovcovem gradu (*t. 3: 7–10*), Desana, Altenerding in Grepault (Milavec 2009, 230–231).

Samostrelne fibule, znane s staroselskih naselbin v jugovzhodnih Alpah, kažejo, da so bile del noše roman-

confirms the dating of the discussed fibulae to the end of the 5<sup>th</sup> and the beginning of the 6<sup>th</sup> century.

The centre of their distribution is the southeastern Alpine territory (*Fig. 2.2*).

### Type Siscia

For this type a short spring, a short bow, and a long conical foot are characteristic (Schulze-Dörrlamm 1986, 635; Milavec 2009, 228–229).

Two iron fibulae (*Pls. 2: 17; 3: 1*) were lying in the destruction layers of phase LA 2. The foot of the second fibula is poorly preserved yet still enough to enable the classification into this type.

It was also proven for this type that the centre of its distribution lies in the Southeastern Alps (Milavec 2009, *Fig. 8*).

### Crossbow knob bow fibulae

#### Type Gurina

For this type a short spring, a short semicircular bow with a loop for the spring axle, and a long knobbed foot and a firm catch plate are characteristic. Knobs on the foot, on the spring axle, and on the bow can be of very different shapes. All fibulae are bronze with an iron spring. They are mostly distributed along the southeastern Alpine area, four examples were found also in Spain. They are dated to the second half of the 5<sup>th</sup> and the beginning of the 6<sup>th</sup> century (Schulze-Dörrlamm 1986, 663–668).

Four examples from the area of building 1 (*Pl. 3: 7–10*) belong to this type. A fibula (*Pl. 3: 10*) was found on the walking surface inside building 1, another one (*Pl. 3: 9*) in a layer of phase LA 2, while there are no data for the remaining two.

The same as the previous types, the type Gurina is also concentrated in the Southeastern Alps (Milavec 2009, *Fig. 11*) but appears also on the Iberian Peninsula.

### Unclassified fibulae

Several more fragments of fibulae with firm catch plate (*Pl. 3: 4–6,14*) were also found but these are too poorly preserved to be classified into types, especially because some types only slightly differ amongst each other. They were lying in layers of phase LA 2 and in a mixed layer.

A part of an iron spring and a bow of a fibula from Tonovcov grad belong to a crossbow knob bow fibula (*Pl. 3: 11*). It is different from other such fibulae which have a loop for the spring axle on the bow. In fibula from

skih staroselcev. Le nekateri primerki samostrelnih fibul z gumbom na loku tipov Gurina in Desana lahko glede na najdbe v grobnih celotah pripadajo tudi Germanom (Schulze-Dorrlamm 1986, 665–666; Glaser 2002, t. 4.).

Zelo verjetno so tovrstne fibule torej nosili tako Romani kot Germani (Milavec 2009, 233), bile pa so del moške in ženske noše (Schulze-Dorrlamm 1986, 686–687).

Fibule istih tipov kot v jugovzhodnih Alpah so bile razširjene tudi na zahodnem Balkanu (*sl.* 2.1, 2.2; Busuladžić 2010).

### OKROGLA FIBULA

Srebrna okrogla fibula s kamnom ali stekelcem v sredini (*t.* 4: 2), ki je ležala v plasti faze PA 2, je podobna fibulama, ki sta bili najdeni v langobardskih grobovih 24 v Nikitschu (Beninger, Mitscha-Märheim 1970, 29; t. 10: 6) in 21 v Hegyköju (Werner 1962, t. 36: 24–25). J. Werner je ti fibuli štel med langobardske. V grobu iz Nikitscha sta bili poleg okrogle fibule najdeni tudi dve S-fibuli tipa Nikitsch-Kranj, ki je datiran v prvo tretjino 6. stoletja (Beninger, Mitscha-Märheim 1970, 29).

Tonovski podobne fibule, s kamnom v sredini in drugačnim okrasom (grebeni v obliki trikotnikov ali cvetnih listov namesto radialnih grebenov okrog kamna), se pojavljajo na frankovsko-alamanskem področju. Zbrane so v tipih Thalmässing ali Kelheim, ki sta oba datirana v prvo polovico 6. stoletja (Koch 1968, t. 95: 9; Losert, Pleterski 2003, 139–143). Dva primerka (eden je zdaj izgubljen) tipa Thalmässing sta bila najdena tudi v grobu 43 na Lajhu v Kranju, ki je z verjetno Teodatovim novcem datiran v čas po 534–536 (Knific 2005, 336).

Fibulo na podlagi teh primerjav oblikovno sicer lahko umestimo v prvo polovico 6. st., vendar je na Tonovcovem gradu verjetneje povezana z obdobjem langobardske prisotnosti po sredini 6. st.

### ROMANSKA LOČNA FIBULA TIPVA VOLTAGO

Bronasta ločna fibula (*t.* 3: 16), okrašena s krožci s piko, je bila najdena v premešani plasti. Spada med staroselske ločne fibule, kakršne so pogosto najdene v Sloveniji, Furlaniji in Benečiji in so opredeljene kot del romanske ženske noše. Med njimi so izločeni trije tipi, Voltago, Trient in Lenzumo, nekatere pa niso uvrščene v tipe (Bierbrauer 1992a). Fibule s trapezasto in trikotno nogo so skupaj poimenovane tip Voltago. Od slovenskih lahko k temu tipu štejemo fibule s Tonovcovega gradu (*t.* 3: 16), Gore nad Polhovim Gradcem (Petru 1967, t. 1: 1; Knific 2004, sl. 7: 1) in z Zidanega gabra (Bitenc 2001, kat. 130; Knific 2004, sl. 7: 3). Kot posnetki germanskih ločnih fibul so datirane v čas po prvi polovici 6. st. ter morda še v 7. st. (Bierbrauer 1992a, 57; Knific 2004, 98).

Tonovcov grad the spring axle is held by the bow which reaches around the axle from the bottom out and up, which is generally characteristic of crossbow fibulae of types Siscia, Passau, Invillino, and certain examples of types Prague and Viminacium and appears in Moesia I and II, Dacia, Dalmatia, and Noricum (Schulze-Dorrlamm 1986, 675). Due to poor preservation the fibula cannot be assigned to any type.

### Conclusion

Crossbow fibulae with firm catch plate developed with Barbaric and German peoples in the 2<sup>nd</sup>-3<sup>rd</sup> century (Ioniță 1998, 232–233; Schulze 1977, 167–168) and crossbow knob bow fibulae in the 4<sup>th</sup> and 5<sup>th</sup> century (Schulze-Dorrlamm 1986, 593, 677; Voss 1998, 276).

At the end of the 5<sup>th</sup> and the beginning of the 6<sup>th</sup> century these fibulae appear only at limited areas in the Roman Empire. Crossbow fibulae with firm catch plate of types Estagel and Duratón are distributed in Spain and southwestern France and are attributed to Western Goths (Schulze-Dorrlamm 1986, 692–694, Fig. 108). The second distribution area of crossbow fibulae with firm catch plate is the Southeastern Alps. Variants Invillino, Lauriacum, and Siscia appear here and also at Tonovcov grad (*Figs.* 2.1, 2.2; *Pls.* 2: 15–17; 3: 1–3), where variant Passau does not appear (Milavec 2009, 226–229). From crossbow knob bow fibulae types Gurina, which is found also at Tonovcov grad (*Pl.* 3: 7–10), Desana, Altenerding, and Grepault appear in the Southeastern Alps (Milavec 2009, 230–231).

Crossbow fibulae appear at the Romanized autochthonous settlements in the Southeastern Alps which indicates that they were part of attire of the Romanized autochthonous people. Only certain examples of crossbow knob bow fibulae of types Gurina and Desana can, considering the finds in grave groups, also belong to Germanic people (Schulze-Dorrlamm 1986, 665–666; Glaser 2002, Pl. 4.).

Thus very probably these fibulae were worn by both, the Roman and Germanic people (Milavec 2009, 233), and were part of the female as well as the male attire (Schulze-Dorrlamm 1986, 686–687).

Fibulae of the same types as in the Southeastern Alps were distributed also in the western Balkans (*Figs.* 2.1, 2.2; Busuladžić 2010).

### ROUND FIBULA

A silver round fibula with a gemstone or glass in the centre (*Pl.* 4: 2), which lay in a layer of phase LA 2, resembles two fibulae found in the Lombard graves 24 in Nikitsch (Beninger, Mitscha-Märheim 1970, 29; Pl. 10: 6) and 21 in Hegykö (Werner 1962, Pl. 36: 24–25). J. Werner classified these two fibulae among the Lombard

## ŽIVALSKA FIBULA V OBLIKI GOLOBA

Srebrna polnoplastična fibula v obliki goloba z neizraženimi krili (*t. 4: 1*) je bila najdena v plasti faze PA 2. Spada med živalske fibule, ki so večinoma datirane v 6. stoletje. V Sloveniji je bila najdena le ena primerljiva bronasta fibula na Trnju pri Škofji Loki (Knific, Sagadin 1991, kat. 72). Pogostejše so na tem prostoru fibule v obliki ploščatih in polplastičnih pavov s trikotno nogo ter petelinov (Knific 2004, 97, sl. 6). V nasprotju z drugimi fibulami v obliki ptic (npr. z omenjenimi ploščatimi in polplastičnimi pavi in petelini) tip polnoplastičnih golobov ni omejen na jugovzhodnoalpski prostor ter staroselske kontekste. Pojavlja se na širokem območju bivšega imperija in tudi v verjetnih germanskih kontekstih. Z nekaj zaključenimi celotami je datiran v čas med sredino 5. in sredino 7. stoletja (Ibler 1991, 21–23, Liste 1c).

## FIBULA V OBLIKI KRIŽA

Fibula iz bronaste pločevine v obliki enakokrakega križa (*t. 3: 15*) je bila najdena v plasti faze PA 2. Fibule v obliki enakokrakega križa so posebej pogoste v severni Italiji (Bierbrauer 1992b, 3), v Sloveniji so dokaj redke. Poleg fibule s Tonovcovega gradu sta znani še fibuli z Rifnika (Pirkmajer 2001, kat. 161) in Svetega Lamberta pri Pristavi nad Stično (Cipot 2003, kat. 4), ki imata sicer obliko grškega križa, vendar sta precej drobnejši.

Fibule v obliki križa so bile najverjetneje značilne za žensko staroselsko nošo med koncem 5. in 7. stoletjem na območju severne Italije, predvsem Furlanije, v uporabi pa so bile tudi drugod v Italiji, Istri in Dalmaciji. Z. Vinski je obravnaval do tedaj znane fibule v obliki križa z območja bivše Jugoslavije in jih datiral v čas med 6. in začetkom 7. st., predvsem pa v drugo polovico 6. stoletja (Vinski 1968, 127–128, 148–149). Enako jih je datirala tudi U. Ibler (Ibler 1991, 31).

## SKLEP

Pri fibulah preseneča količina najdenih rimskih fibul iz časa 1.–2. stoletja (*t. 1: 1–20*). Toliko ni bilo nobene druge vrste zgodnjega gradiva. Ležale so na celotnem območju stavbe 1 brez izrazite koncentracije. Zgodnje-rimske fibule so razmeroma pogoste na poznoantičnih naselbinah in grobiščih (npr. Stare 1980, t. 41: 1; 55: 6; 63: 3; Ciglencečki 1994a, sl. 5: 1–2; 7: 1–2; t. 4: 1–2; 8: 1–2; 9: 1; 11: 1; 12: 1). Na Sv. Hemi so bile najdene na kupu, predvidoma namenjene nadaljnji predelavi (Schretter 1993, 198–199).

Očitno so jih zbirali, težko pa je predvideti zakaj. Morda so jih zbirali zaradi njihove vrednosti, preuporabe ali kot amulete. Na Tonovcovem gradu je bila

fibulae. In the grave from Nikitsch, two S-fibulae of type Nikitsch-Kranj, which is dated to the first third of the 6<sup>th</sup> century (Beninger, Mitscha-Märheim 1970, 29), were also found besides the round fibula.

Fibulae similar to the one from Tonovcov grad with a gem in the centre and a different ornament (triangle- or flower-shaped ridges instead of radial ridges around a central stone), appear in the Frankish-Alamanni territory. They are assembled in types Thalmässing or Kelheim, which are both dated to the first half of the 6<sup>th</sup> century (Koch 1968, Pl. 95: 9; Losert, Pleterski 2003, 139–143). Two examples (one is now lost) of type Thalmässing were found in grave 43 at Lajh in Kranj, which is by the probably Theodatus' coin dated to the time after 534–536 (Knific 2005, 336).

The fibula can on the basis of these comparisons formally be assigned to the first half of the 6<sup>th</sup> century but is at Tonovcov grad more probably connected to the period of the Lombard presence after the mid-6<sup>th</sup> century.

## ROMAN BOW FIBULA TYPE VOLTAGO

A bronze bow fibula (*Pl. 3: 16*) decorated by ring-and-dots was found in a mixed layer. It belongs among autochthonous bow fibulae as are often found in Slovenia, Friuli, and Veneto and are defined as part of the Roman female attire. Among them three types were defined, Voltago, Trient, and Lenzumo, and some are not assigned to types (Bierbrauer 1992a). Fibulae with a trapezoid and triangular foot are commonly named type Voltago. Among Slovenian fibulae, fibulae from Tonovcov grad (*Pl. 3: 16*), Gora above Polhov Gradec (Petru 1967, Pl. 1: 1; Knific 2004, Fig. 7: 1), and Zidani gaber (Bitenc 2001, cat. no. 130; Knific 2004, Fig. 7: 3) can be assigned to this type. As imitations of Germanic bow fibulae they are dated to the time after the first half of the 6<sup>th</sup> century and possibly to the 7<sup>th</sup> century (Bierbrauer 1992a, 57; Knific 2004, 98).

## ANIMAL (PIGEON) FIBULA

A silver figural fibula in the shape of a pigeon with unpronounced wings (*Pl. 4: 1*) was found in a layer of phase LA 2. It belongs among animal fibulae which are mostly dated to the 6<sup>th</sup> century. Only one comparable bronze fibula was found in Slovenia at Trnje near Škofja Loka (Knific, Sagadin 1991, cat. no. 72). Fibulae in the shape of flat or relief peacocks with a triangular foot and of roosters are more frequent in this area (Knific 2004, 97, Fig. 6). Unlike other fibulae in the shape of birds (e.g. the above-mentioned flat and relief peacocks and roosters) the type of figural pigeons is not limited to the southeastern Alpine area and the autochthonous contexts. It appears in the wide area of

možnost zbiranja starih rimskih predmetov še toliko večja zaradi neposredne bližine Gradiča, kjer sta bila rimska naselbina in daritveni prostor. Od tam bi lahko izvirala precejšnja količina omenjenih zgodnjericinskih predmetov. Mogoče pa je, da je bil v rimskem obdobju tudi na Tonovcovem gradu daritveni prostor (glej pogl. 6). Pri kasnejših pregradnjah bi predmeti lahko zašli v plasti poznoantične naselbine. Najdemo jih večinoma namreč ravno v plasteh druge poznoantične faze (PA 2; konec 5. do začetka 7. st.), ne pa tudi v plasteh prve poznoantične faze (PA 1; druga polovica 4. in začetek 5. st.).

Eno od možnih razlag ponujajo najdbe drobnega orodja za obdelavo kovin (stavba 1: *t.* 19: 4,15–16; stavba 2: *t.* 43: 6,11) ali polizdelkov (stavba 2: *t.* 45: 3). Mogoče je šlo za zbiranje starih bronastih predmetov, namenjenih za nadaljnjo predelavo.

V 3. st. sodita le dve kolenčasti fibuli (*t.* 2: 5–6), dobro pa so zastopane fibule iz 4. st. Gre za obročaste fibule (*t.* 2: 1–4), ki se sicer pojavijo že v 3. st., fibule s čebuličastimi gumbi (*t.* 2: 7–9) in fibule tipa Hrušica (*t.* 2: 10–14). Tip Hrušica je ožje regionalen tip, razširjen predvsem v severni Italiji.

Najdeni so bili le trije odlomki fibul s čebuličastimi gumbi (*t.* 2: 7–9), kar je presenetljivo glede na njihovo siceršnje pogostost na poznoantičnih najdiščih in precejšnje količino poznorimske pasne opreme na Tonovcovem gradu (glej pogl. 2.1.3). Razlog je lahko v tem, da so jih v tem delu Slovenije deloma ali skoraj popolnoma nadomestile fibule tipa Hrušica, ki so sočasne, najdenih pa je bilo precej (*t.* 2: 10–14). Večina stratigrafsko opredeljenih fibul tega časa je ležala v plasteh faze PA 2.

Najmlajša je skupina fibul, datirana v konec 5. in v 6. st. To so samostrelne fibule (*t.* 2: 15–17; 3: 1–10), romanska ločna fibula (*t.* 3: 16), križna fibula (*t.* 3: 15) in fibula v obliki goloba (*t.* 4: 1). Fibule kažejo predvsem na lokalno romansko prebivalstvo, vsaj v raziskanem delu najdišča. Posebno samostrelne fibule tipov Inviolino, Lauriacum in Siscia (*t.* 2: 15–17; 3: 1–3; *sl.* 2.1, 2.2) se vežejo na jugovzhodne Alpe in zahodni Balkan. Najdene so bile v plasteh stavbe 1, ki spadajo v drugo poznoantično fazo (PA 2).

Eno samo malo okroglo fibulo (*t.* 4: 2), ki ima primerjave v langobardskih grobovih, bi lahko povezali s prisotnostjo germanske posadke na najdišču.

### 2.1.2 NAKIT

#### SPONKA ZA VERIŽICO

Bronasta sponka za verižico (*t.* 4: 3) je naključna najdba. Takšne sponke se v bronasti in srebrni različici pojavljajo od 4. st. dalje in so v uporabi še vse poznoantično obdobje (Bierbrauer 1987, 162; Martin 1991, 33). Ohranjen je tudi en člen verižice.

the former Empire and also in the probable Germanic contexts. With few closed contexts it is dated to the time between the mid-5<sup>th</sup> and mid-7<sup>th</sup> century (Ibler 1991, 21-23, List 1c).

#### CROSS-SHAPED FIBULA

Fibula made of bronze sheet in the shape of an equilateral cross (*Pl.* 3: 15) was found in a layer of phase LA 2. Fibulae in the shape of an equilateral cross are especially frequent in northern Italy (Bierbrauer 1992b, 3) and are quite rare in Slovenia. Besides the fibula from Tonovcov grad fibulae from Rifnik (Pirkmajer 2001, cat. no. 161) and Sv. Lambert near Pristava above Stična (Cipot 2003, cat. no. 4) are known, but have the shape of a Greek cross and are significantly smaller.

Cross-shaped fibulae are most probably characteristic of the female autochthonous attire between the end of the 5<sup>th</sup> and the 7<sup>th</sup> century in the area of northern Italy, especially Friuli but also elsewhere in Italy, Istria, and Dalmatia. Z. Vinski discussed the cross-shaped fibulae from the area of the former Yugoslavia known until his time and dated them to the time between the 6<sup>th</sup> and the beginning of the 7<sup>th</sup> century, but mostly to the second half of the 6<sup>th</sup> century (Vinski 1968, 127-128, 148-149). They were dated to the same time also by U. Ibler (Ibler 1991, 31).

#### CONCLUSION

Surprising is the number of found Roman fibulae from the time of the 1<sup>st</sup>-2<sup>nd</sup> century (*Pl.* 1: 1-20). No other type of early material appears in such numbers. Fibulae were found in the entire area of building 1 without explicit concentration. Early Roman fibulae are relatively frequent at Late Antique settlements and cemeteries (e.g. Stare 1980, Pls. 41: 1; 55: 6; 63: 3; Ciglencečki 1994a, Figs. 5: 1-2; 7: 1-2; Pls. 4: 1-2; 8: 1-2; 9: 1; 11: 1; 12: 1). At Hemmaberg they were found in a pile, probably intended for further processing (Schretter 1993, 198-199).

They were obviously collected but without an apparent reason why. They could have been collected for their value, reuse or as amulets. At Tonovcov grad the possibility of gathering old Roman objects was even greater due to the immediate proximity of Gradič, where a Roman settlement and a cult place were situated. A significant amount of the mentioned Early Roman objects could have originated from there. It is also possible that a cult place was located at Tonovcov grad "in the Roman period (see chapter 6). The objects could have ended up in the layers of the Late Antique settlement during later demolition or construction. Namely, they are mostly found in layers of the second Late Antiquity phase (LA 2; end of the 5<sup>th</sup> till the beginning of the 7<sup>th</sup> century) and not also in layers

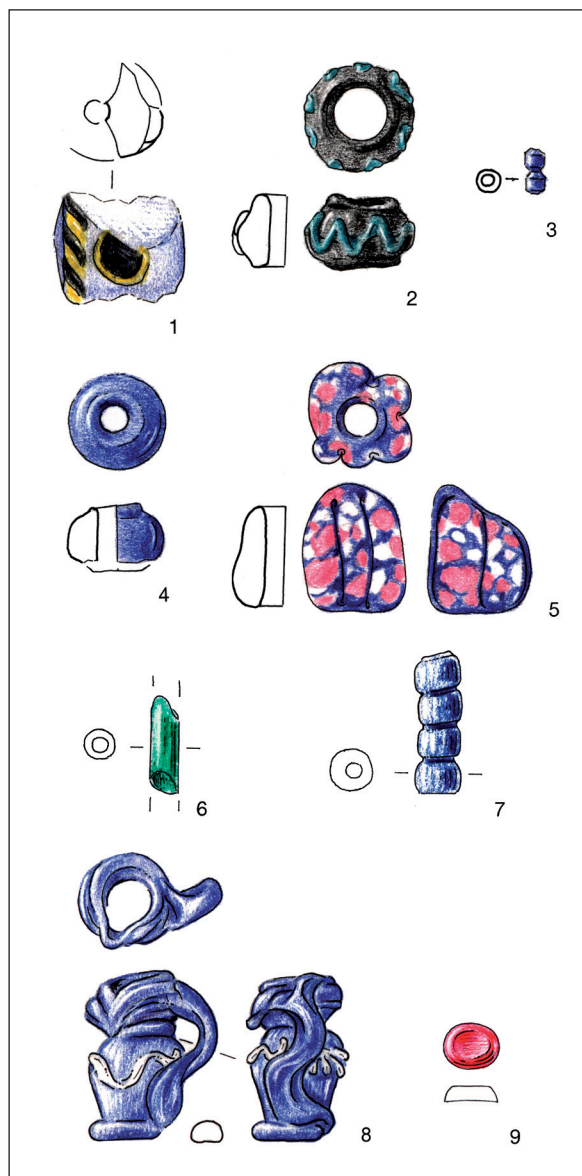

Sl. 2.3: Jagode, obesek in okrasni kamen (?) iz stavbe 1 (t. 4: 4-7, 9-12,28). 1-8 steklo, 9 steklo ali kamen. M. = 1:1.

Fig. 2.3: Beads, a pendant and a gemstone(?) from building 1 (Pl. 4: 4-7,9-12,28). 1-8 glass, 9 glass or stone. Scale = 1:1.

### JAGODE

Vijolično jagodo (t. 4: 9; sl. 2.3: 1), ki je ležala v plasti faze PA 2, lahko uvrstimo v rimsko obdobje (Tempelmann-Maczyńska 1985, 48-52).

Sodčasta jagoda iz kalcedona<sup>6</sup> (t. 4: 8) je bila najdena v plasti faze PA 2. Jagode iz kalcedona so značilna podonavska oblika druge polovice 5. in prve polovice 6. st., izvirale pa naj bi iz južne Rusije (Losert, Pleterski 2003, 266).

<sup>6</sup> Analizo je opravil Miha Jeršek iz Prirodoslovnega muzeja Slovenije v Ljubljani. Za posredovanje in pomoč se zahvaljujem tudi Timoteju Knificu.

of the first Late Antiquity phase (LA 1; second half of the 4<sup>th</sup> and the beginning of the 5<sup>th</sup> century).

An explanation is offered by finds of small tools for the processing of metals (building 1: Pl. 19: 4,15-16; building 2: Pl. 43: 6,11) or intermediate products (building 2: Pl. 45: 3). It is possible that they were collecting old bronze objects with the purpose to process them further.

Only two fibulae (Pl. 2: 5-6) belong to the 3<sup>rd</sup> century, while fibulae of the 4<sup>th</sup> century are well represented. These are penannular fibulae (Pl. 2: 1-4) which appear already in the 3<sup>rd</sup> century, Roman crossbow fibulae (Pl. 2: 7-9), and fibulae type Hrušica (Pl. 2: 10-14). The type Hrušica is a narrow regional type, spread mostly through northern Italy.

Three fragments of Roman crossbow fibulae (Pl. 2: 7-9) were found which is surprising considering their general frequency on Late Roman sites and significant number of Late Roman belt set parts at this site (see chapter 2.1.3). The reason could be that they were in this part of Slovenia partly or almost completely replaced by fibulae type Hrušica, which are contemporary and numerous (Pl. 2: 10-14). Most of the stratigraphically defined fibulae of this time were found in layers of phase LA 2.

The latest is a group of fibulae dated to the end of the 5<sup>th</sup> and the 6<sup>th</sup> century. These are crossbow fibulae (Pls. 2: 15-17; 3: 1-10), a Roman bow fibula (Pl. 3: 16), a cross-shaped fibula (Pl. 3: 15), and a pigeon fibula (Pl. 4: 1). Fibulae point primarily to the local Romanized inhabitants, at least in the researched part of the site. Especially crossbow fibulae of types Invillino, Lauriacum, and Siscia (Pls. 2: 15-17; 3: 1-3; Figs. 2.1, 2.2) are linked to the Southeastern Alps and the western Balkans. They appear in layers of building 1 which belong to the second Late Antiquity phase (LA 2).

Only one small round fibula (Pl. 4: 2), which has parallels in Lombard graves, could be connected to the presence of a Germanic garrison at the site.

## 2.1.2 JEWELLERY

### NECKLACE CLASP

A bronze necklace clasp (Pl. 4: 3) is a chance find. Such clasps appear in bronze and silver versions from the 4<sup>th</sup> century onwards and remain in use through the entire Late Antiquity period (Bierbrauer 1987, 162; Martin 1991, 33). One necklace link is also preserved.

### BEADS

A purple bead (Pl. 4: 9; Fig. 2.3: 1) found in a layer of phase LA 2 can be assigned to the Roman period (Tempelmann-Maczyńska 1985, 48-52).



Črna jagoda z zeleno valovnico (*t. 4: 6; sl. 2.3: 2*) je ležala v ruševinski plasti in ima malo dobrih primerjav. Jagode s preprosto belo ali rumeno (redko rdečo) valovnico so pogoste na merovinskih grobiščih. Starejše so črne, mlajše pa so rdeče in bele (skupini 27 in 32 po Kochovi; Koch 1997, 146). Modrozeleno valovnica se sicer pojavlja na rdečih in belih, kompleksneje okrašenih jagodah mlajše skupine, na črnih jagodah pa je nismo zasledili.

Majhna modra dvodelna jagoda (*t. 4: 4; sl. 2.3: 3*) je bila najdena v plasti faze PA 2. Na grobišču v Eichstettenu v južni Nemčiji so majhne, kroglasto oblikovane dvodelne jagode vodilni tip horizonta I.2, ki je datiran med letoma 520 in 570 (Sasse 2001, 127–128, 134). Pravokotno oblikovane miniaturne jagode v odtenkih zelene barve so na grobiščih Liebenau in Dörverden postavljene v 7. st. (Siegmann 2003, t. L: 17; 2004, 493–508, 552–566).

Modra prosojna jagoda (*t. 4: 5; sl. 2.3: 4*) je bila najdena v plasti, ki v stavbi 1 predstavlja hodno površino. Prosojne jagode so značilne za starejše merovinsko obdobje. Na grobiščih Liebenau in Dörverden na Spodnjem Saškem so datirane med sredino 5. in sredino 6. st. (Siegmann 2003, t. F: 2; 2004, 493–508, 552–566). Po sredini 6. st. naj bi bile ogrlice sestavljene večinoma iz neprosojnih jagod (Siegmann 1997, 136–137). Tudi na grobišču v Altenerdingu so prosojne modre jagode datirane med 450–540/550 (Losert, Pleterski 2003, 65–67).

Melonasta modra jagoda, okrašena z rdečimi in belimi steklenimi drobci (*t. 4: 7; sl. 2.3: 5*), je bila najdena v premešani plasti. Temnomodre jagode (sicer ne melonaste oblike), okrašene z drobci stekla, U. Koch uvršča v skupino 11 in jih datira v čas od začetka preseljevanja ljudstev do sredine 6. st. Ta tehnika okraševanja naj bi se zopet pojavila v sredini 7. st., vendar na črnih jagodah (Koch 1997, 147). Sama melonasta oblika jagode časovno ni natančneje opredeljiva, saj se pojavlja skozi celo antično obdobje in tudi kasneje. Na grobišču v Altenerdingu na Bavarskem so kroglaste do obročaste jagode z nepravilno posejanimi madeži datirane med letoma 450–540/550 (Losert, Pleterski 2003, 64). Dve podobni jagodi, okrašeni s steklenimi drobci, sta bili najdeni v grobu 34 na grobišču v Dravljah, datiranjem med koncem 5. in prvo polovico 6. st. (Bitenc 2001, kat. 203). Jagoda (polovica), okrašena z barvnimi drobci stekla, je bila najdena v ruši ob stolpu 4 na Korinjskem hribu (Ciglencečki 1985, t. 1: 20). To jagodo je že S. Ciglencečki primerjal z jagodo iz knežjega groba v Laa an der Thaya (Ciglencečki 1985, op. 41), datiranega v drugo polovico 5. st. Primerjal jo je tudi z jagodami iz Viminacija, kjer so bile na lokaciji Burdelj v ženskem grobu 28 najdeni dve primerljivi jagodi, v prav tako ženskem grobu 29 pa tri (Zotović 1980, t. VI: 8; VII: 3–4). Oba grobova vsebujeta po en par samostrelnih fibul, v grobu 29 je to par fibul tipa Praga, ki ga M. Schülze-Dörrlamm datira v tretjo četrtino 5. st. (Schülze-Dörrlamm 1986, 603). Primerljive

A barrel-shaped bead made of chalcedony<sup>6</sup> (*Pl. 4: 8*) was found in a layer of phase LA 2. Beads made of chalcedony are a characteristic Danubian form of the second half of the 5<sup>th</sup> and the first half of the 6<sup>th</sup> century and are supposed to originate from southern Russia (Losert, Pleterski 2003, 266).

A black bead with a green wavy line (*Pl. 4: 6; Fig. : 2*) was lying in the destruction layer and has few good comparisons. Beads with a simple white or yellow (rarely red) wavy line are frequent on Merovingian cemeteries. Black ones are earlier, while red and white are later (groups 27 and 32 according to Koch; Koch 1997, 146). A blue and green wavy line generally appears on red and white, more complexly decorated beads of the younger group and were not noticed on black beads.

A small blue two-partite bead (*Pl. 4: 4; Fig. 2.3: 3*) was found in a layer of phase LA 2. At the cemetery in Eichstetten in southern Germany small, annular two-part beads represent the leading type of horizon I.2 which is dated between 520 and 570 (Sasse 2001, 127–128, 134). Rectangular miniature beads in shades of green are dated to the 7<sup>th</sup> century at cemeteries Liebenau and Dörverden (Siegmann 2003, Pl. L: 17; 2004, 493–508, 552–566).

A blue transparent bead (*Pl. 4: 5; Fig. 2.3: 4*) was found in a layer that was the walking surface of building 1. Transparent beads are typical for the earlier Merovingian period. At the cemeteries Liebenau and Dörverden in Lower Saxony they are dated between the mid-5<sup>th</sup> and the mid-6<sup>th</sup> century (Siegmann 2003, Pl. F: 2; 2004, 493–508, 552–566). After the middle of the 6<sup>th</sup> century necklaces were supposedly assembled mostly of opaque beads (Siegmann 1997, 136–137). At the cemetery in Altenerding the transparent blue beads are also dated between 450 and 540/550 (Losert, Pleterski 2003, 65–67).

A melon-shaped blue bead decorated by red and white glass fragments (*Pl. 4: 7; Fig. 2.3: 5*) was found in a mixed layer. Dark blue beads (but not melon-shaped) decorated by glass fragments are assigned by U. Koch to group 11 and dated to the time from the beginning of the migration of peoples to the middle of the 6<sup>th</sup> century. This decoration technique supposedly reappeared in the mid-7<sup>th</sup> century but on black beads (Koch 1997, 147). The melon-shape of the bead is not possible to date precisely for it appears throughout the entire Antique period and even later. At the cemetery in Altenerding in Bavaria globular to ring-shaped beads with randomly set stains are dated between 450 and 540/550 (Losert, Pleterski 2003, 64). Two similar beads decorated by glass fragments were found in grave 34 at the cemetery in Dravljah, which is dated between the end of the 5<sup>th</sup> and the first half of the 6<sup>th</sup> century (Bitenc 2001, cat. no. 203). A bead (one

<sup>6</sup> The analysis was done by Miha Jeršek from the Prirodoslovni muzej Slovenije in Ljubljana. Many thanks also to Timotej Knific for his intervention and help.

jagode so bile najdene tudi na grobišču Greblje v Kninu v grobovih dveh deklic, 53 in 84 (Vinski 1989, t. IX: 8; XIV: 2). Grob 84 vsebuje tudi majhno mediteransko pasno spono in ga lahko datiramo v drugo polovico 6. st. Glede na našete primerjave lahko modre jagode z rdečimi in belimi pikami umestimo v drugo polovico in konec 5. st., seveda pa so jih lahko uporabljali tudi kasneje.

V stavbi 1 je bila v zgodnj srednjeveški plasti najdena zelena cevasta jagoda (*t. 4: 11; sl. 2.3: 6*). Take jagode so bile v rabi celo poznoantično obdobje in tudi kasneje, na primer na grobišču Mellnau I, kjer so najdene v grobu, datiranjem v konec 7. st. (Stiegemann, Wemhoff 1999, 273, kat. V.2), in na grobiščih Liebenau in Dörverden, kjer so datirane v 8. st. (Siegmann 2003, t. M: 13; 2004, 493–508, 552–566).

Štiridelna modra jagoda (*t. 4: 10; sl. 2.3: 7*) je prav tako ležala v zgodnj srednjeveški plasti v stavbi 1. Večdelne jagode se pojavljajo že v antiki in pozni antiki, vendar so precej manjše (prim. Knific 2001, kat. 124). Zgodnj srednjeveške večdelne jagode so večje in večinoma modre barve. R. Andrae jih je v povezavi z jagodami millefiori s historično metodo datiral v prvo tretjino 9. st. (Andrae 1973, 155). D. Staššiková-Štukovská in A. Plško jih postavljata kot značilne za svojo 3. fazo, ki je datirana do leta 800 (Staššiková-Štukovská, Plško 1997, 262–264). J. Callmer jih za Skandinavijo in območje Baltika datira med drugo polovico 8. do prve četrtine 9. st. (Callmer 1997, t. 16). Tako datacijo lahko predlagamo tudi za tonovsko jagodo.

## OBESKI

Moder steklen obesek v obliki enoročajnega vrčka (*t. 4: 12; sl. 2.3: 8*), okrašen z belo valovnico, je bil najden v premešani plasti. Podobni se pojavljajo v poznorimski dobi na območju celotnega imperija, predvsem pa v vzhodnem Sredozemlju. Datirani so večinoma v 4., nekateri tudi v začetek 5. st. (Wamser 2004, kat. 593–595).

V premešani plasti sta bila najdena majhen okrogel obesek iz bronaste pločevine z luknjo (*t. 4: 13*) in majhen železen obesek(?) v obliki črke omega (*t. 4: 14*). Edino primerjavo obesku v obliki omega smo našli v grobu 85 na kölnskem grobišču Müngersdorf, datiranjem v 6. in 7. st., kjer je ležal ob rami ženskega skeleta poleg železnega tulca (Fremersdorf 1955, t. 14: 3).

## PRSTANI

Na območju stavbe 1 je bilo najdenih trinajst celih prstanov (*t. 4: 15–27*), trije obročki (*t. 4: 29; 5: 1–2*) in en okrasni kamen (*t. 4: 28*). Večinoma so železni (*t. 4: 15–23*), štirje prstani in dva obročka so bronasti (*t. 4: 24–27; 5: 1–2*), najmanjši obroček (*t. 4: 29*) pa je srebrn. Vsi razen prstana (*t. 4: 15*) in obročka (*t. 5: 2*),

half) decorated by coloured glass fragments was found in the humus outside tower 4 at Korinjski hrib (Ciglencečki 1985, Pl. 1: 20). This bead was compared to the bead from the princely grave in Laa an der Thaya already by S. Ciglencečki (Ciglencečki 1985, note 41) and the grave is dated to the second half of the 5<sup>th</sup> century. Ciglencečki also compared it to beads from Viminacium, where two comparable beads were found on the location Burdelj in female grave 28 and three were found in female grave 29 (Zotović 1980, Pls. VI: 8; VII: 3–4). Both graves include a pair of crossbow fibulae each, in grave 29 this is a pair of fibulae of the Prague type which are dated by M. Schülze-Dörrlamm to the third quarter of the 5<sup>th</sup> century (Schülze-Dörrlamm 1986, 603). Comparable beads were found also at the cemetery Knin-Greblje, in graves of two girls, 53 and 84 (Vinski 1989, Pls. IX: 8; XIV: 2). Grave 84 also includes a small Mediterranean belt buckle and can be dated to the second half of the 6<sup>th</sup> century. Considering the enumerated comparisons blue beads with red and white dots can be assigned to the second half and the end of the 5<sup>th</sup> century, but were certainly also used later on.

A green tubular bead (*Pl. 4: 11; Fig. 2.3: 6*) was found in the Early Medieval layer of building 1. Such beads were used through the entire Late Antique period and also later, for example at the cemetery Mellnau I where they are found in a grave dated to the end of the 7<sup>th</sup> century (Stiegemann, Wemhoff 1999, 273, cat. no. V.2) and at cemeteries Liebenau and Dörverden where they are dated to the 8<sup>th</sup> century (Siegmann 2003, Pl. M: 13; 2004, 493–508, 552–566).

A four-partite blue bead (*Pl. 4: 10; Fig. 2.3: 7*) was also found in the Early Medieval layer within building 1. Segmented beads appear in the Antiquity and Late Antiquity but are significantly smaller (cf. Knific 2001, cat. no. 124). Early Medieval segmented beads are bigger and mostly blue. R. Andrae dated them using the historical method in connection with the millefiori beads to the first third of the 9<sup>th</sup> century (Andrae 1973, 155). D. Staššiková-Štukovská and A. Plško regard them as typical of their phase 3 which is dated up until 800 (Staššiková-Štukovská, Plško 1997, 262–264). J. Callmer dates them for Scandinavia and the area of Baltic between the second half of the 8<sup>th</sup> to the first quarter of the 9<sup>th</sup> century (Callmer 1997, Pl. 16). This date can also be proposed for the bead from Tonovcov grad.

## PENDANTS

A blue glass pendant in the shape of a one-handle jug (*Pl. 4: 12; Fig. 2.3: 8*) decorated by a white wavy line was found in a mixed layer. Similar pendants appear in the Late Roman period in the entire Empire but mostly in the eastern Mediterranean. They are mostly dated to the 4<sup>th</sup> and some to the beginning of the 5<sup>th</sup> century (Wamser 2004, cat. no. 593–595).

ki sta bila najdena v plasti faze PA 1, so ležali v plasteh faze PA 2 (*t. 4: 20,24–25*) in v premešanih plasteh (*t. 4: 15–19,21–23,26,27,29; 5: 1*).

Bronast prstan z narebnim obročem (*t. 4: 24*) spada v tip 2.24 po E. Riha. Ta tip je bil pogost v renskih in donavskih provincah, pojavlja se tudi v Panoniji, datiran pa je v prvo polovico 4. st. (Riha 1990, 44; Keller 1971, 108–109). Da je bila ta preprosta oblika v rabi tudi v kasnejšem času, dokazuje na primer narebni prstan iz groba 233 na grobišču v Eichstettnu, ki je datiran v sredino 7. st. (Sasse 2001, t. 102: 4).

Več je železnih prstanov s tankim obročem in razširitvijo ali ploščico, ki je bila verjetno okrašena, vendar so predmeti tako slabo ohranjeni, da tega ni mogoče ugotoviti. V treh primerih je ploščica okrogla (*t. 4: 19–20,23*), v enem pravokotna (*t. 4: 22*), v enem pa ovalna (*t. 4: 18*). Bronaste prstane teh oblik datira E. Keller v srednjo in zadnjo tretjino 4. st. (Keller 1971, 109), E. Riha pa v konec 3. in 4. st., pojavljajo pa se v Podonavju, Porenju in v Panoniji (tip 2.8.2.; Riha 1990, 35–36). V poznoantičnem obdobju se v bronastih, pa tudi srebrnih in zlatih izvedbah pojavljajo v Italiji (Riemer 2000, 96–97). Preprostejše, večinoma železne različice so pogoste na poznoantičnih najdiščih vzhodnoalpskega kroga (Stare 1980, t. 122: 6,8; Bolta 1981, t. 17: 5; Knific, Sagadin 1991, kat. 56, 58, 60; Felgenhauer-Schmiedt 1993, t. 38: 2).

Dva železna prstana imata nesklenjeno razširitev (*t. 4: 16–17*). Za bronaste primerke teh prstanov E. Riha meni, da so ostanki prstanov s kamni, ki pa so se izgubili, ostala naj bi le podlaga. Umešča jih v 4. st., pojavljali pa naj bi se v večini provinc imperija (tip 11; Riha 1990, 36–37).

Železen prstan (*t. 4: 15*), ki je bil najden v plasti faze PA 1, ima namesto ploščice pravokoten izrastek. Bronaste prstane teh oblik datira E. Keller v srednjo in zadnjo tretjino 4. st. (Keller 1971, 109), E. Riha pa v konec 3. in 4. st., pojavljajo pa se v Podonavju, Porenju in v Panoniji (tip 2.8.2.; Riha 1990, 35–36).

Eden od železnih prstanov je imel morda vstavljen kamen ali steklen vložek (*t. 4: 21*). Po E. Riha spada v tip 2.1.2., kamor sodijo železni prstani s kamni v stari, še helenistični tradiciji. Posebej priljubljeni so bili v 1. st., v rabi pa tudi še pozneje (Riha 1990, 30).

Dva prstana sta preprosta trakasta obročka s presegajočimi konci, prvi je narejen iz belega bronu<sup>7</sup> (*t. 4: 25*), drugi je bronast (*t. 4: 26*).

Z detektorjem kovin pred začetkom izkopavanj je bil najden tudi velik bronast prstan s kamnom (*t. 4: 27*). Domnevno sodi v 14. st. (Ciglencečki 1994b, op. 23). Zelo podoben je srebrnemu prstanu s prostora nekropole Cella v Čedadu, ki je datirana v konec 6. in začetek 7. st., vendar provenienca tega prstana ni zanesljiva (Menis 1990, 461; X.171; Brozzi 1987, 241). Podobno

<sup>7</sup> Bron s 30–50 % kositra. Analizo je opravil Žiga Šmit na Institutu Jožefa Stefana v Ljubljani.

A small round pendant made of bronze sheet with a hole (*Pl. 4: 13*) and a small iron pendant (?) in the shape of the letter omega (*Pl. 4: 14*) were found in a mixed layer. The only parallel for the omega-shaped pendant was found in grave 85 at the Cologne cemetery Müngersdorf, which is dated to the 6<sup>th</sup> and 7<sup>th</sup> century. The pendant was there positioned along the shoulder of a female skeleton, beside an iron object (Fremersdorf 1955, Pl. 14: 3).

## FINGER RINGS

Thirteen complete finger rings (*Pl. 4: 15–27*), three rings (*Pls. 4: 29; 5: 1–2*), and one ornamental (gem) stone (*Pl. 4: 28*) were found in the area of building 1. They are mostly iron (*Pl. 4: 15–23*), four finger rings and two rings are bronze (*Pls. 4: 24–27; 5: 1–2*), while the smallest ring (*Pl. 4: 29*) is silver. All except a finger ring (*Pl. 4: 15*) and a ring (*Pl. 5: 2*), which were found in a layer of phase LA 1, were lying in layers of phase LA 2 (*Pl. 4: 20,24–25*) and in mixed layers (*Pls. 4: 15–19,21–23,26–27,29; 5: 1*).

A bronze finger ring with a ribbed band (*Pl. 4: 24*) belongs to type 2.24 according to E. Riha. This type is frequent in Rhine and Danubian provinces and appears in Pannonia, it is dated to the first half of the 4<sup>th</sup> century (Riha 1990, 44; Keller 1971, 108–109). That this simple form also appears later is proven by, for example, a ribbed finger ring from grave 233 at the cemetery in Eichstetten, which is dated to the mid-7<sup>th</sup> century (Sasse 2001, Pl. 102: 4).

There are quite a few iron finger rings with a thin band and a widening or a platelet, which was probably decorated, but the objects are so poorly preserved that this is impossible to conclude. In three examples the platelet is round (*Pl. 4: 19–20,23*), in one rectangular (*Pl. 4: 22*), and in one oval (*Pl. 4: 18*). Bronze rings of these shapes are dated by E. Keller to the middle and the last third of the 4<sup>th</sup> century (Keller 1971, 109), while E. Riha dates them to the end of the 3<sup>rd</sup> and to the 4<sup>th</sup> century. They appear in the regions of the Danube, the Rhine, and in Pannonia (Type 2.8.2.; Riha 1990, 35–36). During the Late Antiquity they appear in bronze, and also silver and golden versions in Italy (Riemer 2000, 96–97). Simpler, mostly iron versions are frequent at the Late Antique sites of the eastern Alps (Stare 1980, Pl. 122: 6,8; Bolta 1981, Pl. 17: 5; Knific, Sagadin 1991, cat. nos. 56, 58, 60; Felgenhauer-Schmiedt 1993, Pl. 38: 2).

Two iron finger rings have a band with ends which don't meet (*Pl. 4: 16–17*). For the bronze examples of these rings E. Riha believes that they are remnants of finger rings with stones which were lost so that only the base remained. She assigns them to the 4<sup>th</sup> century. They supposedly appeared in most provinces of the Empire (Type 11; Riha 1990, 36–37).

An iron finger ring (*Pl. 4: 15*) that was found in a layer of phase LA 1 has a rectangular knob instead of a

je oblikovan tudi kamen na zlatem prstanu iz ženskega groba 38 z alamanskega grobišča v Güttingenu (Steuer 1997, 277). Bronast primerak povsem enake oblike kot tonovski, le kamen je brušen malo drugače, je bil najden na nekropoli v Žminju, vendar zunaj grobov kot posamična najdba, tako da časovno ni izpoveden (Marušić 1986–1987, t. XIX: 6). Nekropola je datirana med letoma 840–950. Za zdaj moramo pustiti datacijo tega prstana odprto.

V plasti faze PA 2 je bil najden majhen rdeč neokrašen okrasni kamen (*t. 4: 28; sl. 2.3: 9*).

V plasti faze PA 1 je ležal preprost nesklenjen bronast obroček s stanjšanimi konci in okroglim presekom (*t. 5: 2*). Tovrstne prstane je E. Riha opredelila v tip 2.32, v zgodnje obdobje med 1. in 3. st. (Riha 1990, 46).

Bronast obroček (*t. 5: 1*) je ležal v premešani plasti.

Srebrn nesklenjen obroček (*t. 4: 29*) lahko predstavlja prstan, del ogrlice ali morda uhan, najden pa je bil v ruševini.

Na slovenskih poznoantičnih najdiščih sta pogosti dve obliki prstanov, ki sta razmeroma kronološko neobčutljivi. To so preprosti obročki in železni prstani z razširitvijo ali ploščico za okrasni kamen (Ciglencečki 1994a, sl. 7: 6; t. 10a: 15; Knific 2001, kat. 123: 12; 124). Dragoceni prstani se v poznoantičnem času pojavljajo predvsem na bizantinskih vplivnih območjih južne Italije in otokov (Riemer 2000, 95) ali v bogatejših, pogosto germanskih kontekstih (Slabe 1975, t. 1: 7; Vinski 1980, 22).

## ZAPESTNICE

V izkopnem polju stavbe 1 je bilo najdenih devet zapestnic in njihovih odlomkov (*t. 5: 7–15*).

Večinoma so ležale v plasteh faze PA 2 (*t. 5: 10, 12, 15*) in premešanih plasteh, dve pa sta iz zgodnje-srednjeveških plasti stavbe 1 in prizidka (*t. 5: 7, 8*).

Zapestnica (*t. 5: 10*) je železna s polkrožnim presekom. Železne zapestnice se pojavljajo v grobovih druge polovice 4. st. v Panoniji, kjer so jih morda prevzeli od Sarmatov. V zahodnih provincah se niso uveljavile pred začetkom 5. st. (Martin 1991, 16–17). Konec 5. in v 6. st. predstavljajo zelo značilen nakit staroselskega prebivalstva v jugovzhodnih Alpah (Riemer 2000, 92; Knific 2004, 96–97, sl. 8: 10).

Dve bronasti zapestnici sta lečastega preseka. Prva (*t. 5: 8*) je majhnega premera in ima en zaključek odebeljen. Lahko je bila predelana iz večje zapestnice z odebeljenima zaključkoma, ki se je zlomila ali poškodovala (prim. Uenzen 1992, 167, t. 7: 1). Druga (*t. 5: 7*) je le delno ohranjena, z enakomerno tankim presekom.

Od bronaste zapestnice (*t. 5: 9*) z lečastim do polkrožnim presekom se je ohranil le fragment.

Bronasta zapestnica (*t. 5: 11*) je okroglega preseka z zaključki v obliki zelo poenostavljenih kačjih glav.

platelet. Bronze finger rings of these forms are by E. Keller dated to the middle and last third of the 4<sup>th</sup> century (Keller 1971, 109), while E. Riha dates them to the end of the 3<sup>rd</sup> and to the 4<sup>th</sup> century. They appear in the area of the Danube, the Rhine, and in Pannonia (type 2.8.2.; Riha 1990, 35–36).

One of the iron finger rings could have had a gem or glass inserted into it (*Pl. 4: 21*). According to E. Riha it belongs to type 2.1.2., this is iron finger rings with gems of the old, Hellenistic tradition. They are especially popular in the 1<sup>st</sup> century but remain in use also later (Riha 1990, 30).

Two finger rings are simple sheet bands with surpassing ends, the first is made of white bronze<sup>7</sup> (*Pl. 4: 25*), the other is bronze (*Pl. 4: 26*).

A big bronze finger ring with a gem (*Pl. 4: 27*) was found with the metal detector prior to the beginning of the excavations. The ring supposedly belongs to the 14<sup>th</sup> century (Ciglencečki 1994b, note 23). It is very similar to the silver ring from the necropolis Cella in Cividale del Friuli which is dated to the end of the 6<sup>th</sup> and the beginning of the 7<sup>th</sup> century, but the provenience of this ring is not certain (Menis 1990, 461; X.171; Brozzi 1987, 241). The gem in the golden finger ring from female grave 38 from the Alamanni cemetery in Güttingen (Steuer 1997, 277) is shaped similarly. A bronze example of completely identical shape as the one from Tonovcov grad but with a differently polished gem was found at the necropolis in Žminj. But it was found outside the graves as an individual find, therefore it cannot be precisely dated (Marušić 1986–1987, Pl. XIX: 6). The necropolis is dated between 840 and 950. For now the dating of this finger ring must remain open.

A small red undecorated gemstone (*Pl. 4: 28; Fig. 2.3: 9*) was found in a layer of phase LA 2.

A simple bronze ring with thinned ends which don't meet and of round cross section (*Pl. 5: 2*) was lying in a layer of phase LA 1. Such rings were delimited by E. Riha to type 2.32., to the early period between the 1<sup>st</sup> and the 3<sup>rd</sup> century (Riha 1990, 46).

A bronzing (*Pl. 5: 1*) was found in a mixed layer.

A silver ring with ends which don't meet (*Pl. 4: 29*) could represent a finger ring, a part of a necklace or possibly an earring. It was found in the destruction layer.

Two forms of rings which are chronologically relatively insensitive are frequent on Slovenian Late Antique sites. These are simple bands and iron finger rings with a widening or a platelet for a gem (Ciglencečki 1994a, Fig. 7: 6; Pl. 10a: 15; Knific 2001, cat. nos. 123: 12; 124). Precious rings appear in Late Antiquity mostly in the areas influenced by Byzantium, i.e. in southern Italy and the islands (Riemer 2000, 95) or in richer, often Germanic contexts (Slabe 1975, Pl. 1: 7; Vinski 1980, 22).

<sup>7</sup> Bronze with 30–50 % of tin. The analysis was conducted by Žiga Šmit at the Institut Jožef Stefan in Ljubljana.

Bronast trak (t. 5: 12) z okraši krogcev in pik je tudi lahko del zapestnice.

Odlomek zapestnice (t. 5: 13) iz bronaste pločevine je okrašen s prečnimi črtami in zaključkom v obliki stilizirane živalske glave.

Košček okrašenega bronastega traku lahko pripada zapestnici (t. 5: 14).

Zapestnica (t. 5: 15) iz bronaste pločevine je ohranjena le delno, slabo je ohranjen okras prečnih črt in štirilistnega cveta.

Enako kot prstani, uhani in igle so tudi zapestnice tipičen rimski nakit 4. st., katerega oblike se nadaljujejo tudi v pozni antiki (Vinski 1980, 22; Knific 2004, 96–97, sl. 5: 10,12).

## UHANI

Najdeni so bili trije bronasti uhani s poliedrom (t. 5: 3–5). Taki uhani so se uporabljali v romanski ženski noši od konca 4. st. dalje, nekoliko kasneje tudi v vzhodnogermanski (zahodno- in vzhodnogotski) ženski noši. Uhan (t. 5: 3), ki je bil najden v plasti zunanje hodne površine stavbe 1, je majhnega premera z razmeroma velikim poliedrom. To je v grobem značilno za poznorimske primerke (npr. uhan iz groba 5 na Ptujskem gradu, datiran v konec 4. in začetek 5. st.: Korošec 1968, t. 1: 4). Uhani s konca 5. in 6. st. imajo večinoma večji premer in sorazmerno manjši polieder (npr. Knific 2004, sl. 5: 6–7). Takšna sta druga dva uhana. Uhan (t. 5: 4) je bil najden v plasti faze PA 2, uhan (t. 5: 5, detektorska najdba) je večjega premera, polieder je okrašen s krožci s piko.

V prvi polovici 5. st. so uhane s poliedrom prevzeli na alamanskem in kasneje frankovskem območju, tako da so v 6. stoletju tam zelo široko razprostranjeni, ne pojavljajo pa se na primer pri Langobardih. Severno od Alp so se ohranili še v 7. stoletju (Freeden 1979, 249–298; Vinski 1980, 22; Bierbrauer 1987, 150; Riemer 2000, 43–44; Losert, Pleterski 2003, 54). Po Bierbrauerjevem mnenju sredozemske grobne celote z uhani s poliedrom spadajo v 6. st., pomanjkanje celot iz 5. st. pa je poskusil razložiti s tem, da takrat niso dajali pridatkov v grobove (Bierbrauer 1987, 150). V Sloveniji je bila večina uhanov s poliedri dejansko najdena v grobovih na Lajhu v Kranju (Stare 1980, t. 80: 2–3; 106: 4–5), na Rifniku (Bolta 1981, t. 3: 1–2, 12–14; 5: 6–7; 9: 1,3; 11: 2; 12: 6–7; 16: 1–2,9; 17: 6–8), na blejski Pristavi (Knific 2004, 96–98, sl. 5: 6–7) in na Križišču Iskra v Kranju (Sagadin 1988, t. 2: 6–7), ki so vsi datirani v 6. st.

Na velikem luničastem uhanu (t. 5: 6, detektorska najdba) je vtisnjen okras, ki spominja na žige na pečatni keramiki. Luničasti uhani se v 6. stoletju v razkošnejših zlatih in srebrnih izvedbah pojavljajo predvsem v vzhodnem Sredozemlju in južni Italiji ter na Siciliji. Preprostejši bronasti primerki se pojavljajo šele v 7. in

## BRACELETS

In the excavation area of building 1 nine bracelets and their fragments (Pl. 5: 7-15) were found.

Bracelets were mostly lying in layers of phase LA 2 (Pl. 5: 10,12,15) and in mixed layers, while two were found in the Early Medieval layers of building 1 and the outhouse (Pl. 5: 7-8).

A bracelet (Pl. 5: 10) is made of iron and has a semi-circular cross section. Iron bracelets appear in graves of the second half of the 4<sup>th</sup> century in Pannonia, where they could have been adopted from the Sarmatians. In western provinces they were not popular before the beginning of the 5<sup>th</sup> century (Martin 1991, 16-17). At the end of the 5<sup>th</sup> and in the 6<sup>th</sup> century they represent a very characteristic jewellery of the autochthonous people in the Southeastern Alps (Riemer 2000, 92; Knific 2004, 96-97, Fig. 8: 10).

Two bronze bracelets have a lentil-shaped cross section. The first (Pl. 5: 8) is of small diameter and one of its endings is thickened. It could have been remade from a bigger bracelet with thickened endings which was broken or damaged (cf. Uenze 1992, 167, Pl. 7: 1). The second one (Pl. 5: 7) is fragmentarily preserved and has an evenly thin diameter.

Only a fragment is preserved from a bronze bracelet (Pl. 5: 9) with a lentil-shaped or semi-circular cross section.

A bronze bracelet (Pl. 5: 11) has a round cross section with endings shaped as very simplified snake heads.

A bronze band (Pl. 5: 12) with the decoration of ring-and-dots could also be a part of a bracelet.

A bracelet fragment (Pl. 5: 13) made of bronze sheets decorated by transversal lines and an ending in the shape of a stylised animal head.

A piece of a decorated bronze band could belong to a bracelet (Pl. 5: 14).

A bracelet (Pl. 5: 15) made of bronze sheet is fragmentarily preserved, the decoration of transversal lines and four-petal flower is poorly preserved.

Together with finger rings, earrings, and pins bracelets represent a typical Roman jewellery of the 4<sup>th</sup> century, the forms of which continue into the Late Antiquity (Vinski 1980, 22; Knific 2004, 96-97, Fig. 5: 10,12).

## EARRINGS

Three bronze earrings with a polyhedron (Pl. 5: 3-5) were found. Earrings with a polyhedron appear in Roman female attire from the end of the 4<sup>th</sup> century onwards, slightly later also in the East Germanic (Western and Eastern Gothic) female attire. An earring (Pl. 5: 3) that was found in the outer walking surface of building 1 has a small diameter with a relatively big polyhedron. This is roughly typical of Late Roman examples (e.g. the

8. stoletju med staroselskim gradivom severne Italije, predvsem Furlanije, kjer najdemo tudi najboljše primerjave za tonovski uhan (Korošec 1961, t. III: 3–5; Brozzi 1989, t. 9: 12; 10: 1–4,7–8).

Košček srebrne pločevine (t. 5: 20), najden v plasti faze PA 2, je težko natančneje opredeliti. Morda je pripadal obesku uhana, lahko pa tudi kakšnemu drugemu predmetu.

## IGLE

Srebrna igla s ptico (pavom; t. 5: 17) je bila najdena v premešani plasti zunaj stavbe 1.

Igle s pticami je zadnji zbral T. Vida (2009). Na njih se večinoma pojavljajo golobice, le redko petelini in pavi. Vezane so na vzhodno Sredozemlje, v zahodnem so bile le redke (Vida 2009, 244–249, sl. 4–6). Podobna igla, prvotno verjetno z dvema pticama, je bila na primer najdena v Siparu pri Umagu, datirana je v 6. ali 7. st. (Marušić 1995, kat. 258). Primerek s tonovcovega gradu spada med kvalitetnejše kose in ga lahko postavimo v bizantinski kontekst 6. in 7. st.

Najdenih je bilo deset bronastih in železnih igel v obliki stilusa (t. 5: 18; 6: 1–9). Večina jih je ležala v plasteh faze PA 2 (t. 5: 18; 6: 4,7–9) in premešanih plasteh, ena (t. 6: 6) pa je iz zgodnesrednjeveške plasti.

Takšne igle (t. 5: 18; 6: 1–4) so se v rimskem obdobju uporabljale bolj kot kozmetični ali medicinski pripomoček, v pozni antiki pa naj bi bile del noše in se uporabljale za spenjanje las ali obleke. V uporabi so bile tudi v germanskem svetu, čeprav v manjši meri. Pri Alamanih in Frankih so bile nekoliko pogostejše igle z neizrazito glavo. Igle v obliki stilusa lahko okvirno datiramo med drugo polovico 4. in 7. st. (Möller 1976–1977; Vinski 1980, 21–22; Bierbrauer 1987, 161–162; Riemer 2000, 104).

Železne izvedbe so zelo redke, v Sloveniji sta poleg šestih tonovskih (t. 6: 5–9; stavba 3: t. 45: 9) objavljeni le dve neokrašeni železni igli te oblike, ena iz groba 31 s kranjskega Lajha (Stare 1980, t. 16: 7) in ena iz naselbine na Limberku (Ciglencečki 1985, t. 8: 92).

Mala bronasta igla (t. 5: 19) z okroglo glavo, okrašeno s tremi vrezi, je ležala v premešani plasti. Spominja na preproste rimske in poznorimske igle, pa tudi na kratke, večinoma srebrne igle z okroglo ali bikonično glavo, ki naj bi se glede na lego v grobovih uporabljale kot lasnice oz. za pripenjanje pokrivala ali pajčolana (Möller 1976–1977, 14–18; Riemer 2000, 106).

Železne igle z uvito sploščeno glavico (t. 6: 10–15) so ležale v plasti faze PA 1 (t. 6: 13), v zgodnesrednjeveški plasti v prizidku stavbe 1 (t. 6: 12) in v plasteh faze PA 2 (t. 6: 10–11, 14–15). Njihove funkcije ne poznamo. Po obliki so podobne bronastim iglam z uvito glavo iz poznoantičnih in zgodnesrednjeveških plasti v Kopru

earring from grave 5 at the castle of Ptuj, which is dated to the end of the 4<sup>th</sup> and the beginning of the 5<sup>th</sup> century: Korošec 1968, Pl. 1: 4). Earrings of the end of the 5<sup>th</sup> and the 6<sup>th</sup> century generally have a bigger diameter and a proportionally smaller polyhedron (e.g. Knific 2004, Fig. 5: 6–7). The other two earrings are just like that. An earring (Pl. 5: 4) was found in a layer of phase LA 2, while an earring (Pl. 5: 5, metal detector find) has a bigger diameter and the polyhedron is decorated by ring-and-dots.

During the first half of the 5<sup>th</sup> century they were adopted on the Alamanni and later also the Frankish territory, which means that in the 6<sup>th</sup> century these are widely distributed along these territories, but do not appear with, for example, the Lombards. North of the Alps they persisted into the 7<sup>th</sup> century (Freeden 1979, 249–298; Vinski 1980, 22; Bierbrauer 1987, 150; Riemer 2000, 43–44; Losert, Pleterski 2003, 54). Bierbrauer believes that the Mediterranean grave groups with earrings with a polyhedron belong to the 6<sup>th</sup> century. He tried to explain the lack of grave groups from the 5<sup>th</sup> century by the notion that grave goods were not placed in graves in that time (Bierbrauer 1987, 150). In Slovenia, most of the earrings with a polyhedron are actually found in graves at Lajh in Kranj (Stare 1980, Pls. 80: 2–3; 106: 4–5), at Rifnik (Bolta 1981, Pls. 3: 1–2, 12–14; 5: 6–7; 9: 1,3; 11: 2; 12: 6–7; 16: 1–2,9; 17: 6–8), at Pristava in Bled (Knific 2004, 96–98, Fig. 5: 6–7), and at Križišče Iskra in Kranj (Sagadin 1988, Pl. 2: 6–7), all of which are dated to the 6<sup>th</sup> century.

On a big crescent-shaped earring (Pl. 5: 6, metal detector find) a decoration is impressed which resembles seals on stamped pottery. Crescent-shaped earrings appear in luxurious golden and silver versions mostly in the eastern Mediterranean, in southern Italy and Sicily in the 6<sup>th</sup> century. Simpler bronze examples appear among the autochthonous Romanised material of northern Italy, especially of Friuli, not before the 7<sup>th</sup> and 8<sup>th</sup> century. The best analogies for the earring from Tonovcov grad are found here (Korošec 1961, Pl. III: 3–5; Brozzi 1989, Pls. 9: 12; 10: 1–4,7–8).

A piece of silver sheet (Pl. 5: 20) found in a layer of phase LA 2 is difficult to define precisely. It could have belonged to an earring pendant or to some other object.

## PINS

A silver pin with a bird (a peacock; Pl. 5: 17) was found in a mixed layer outside building 1.

Pins with birds were last collected by T. Vida (2009). Such pins mostly have depictions of doves, rarely of roosters and peacocks. They are tied to the eastern Mediterranean and rarely appear in its western part (Vida 2009, 244–249, Fig. 4–6). A similar pin, which originally probably had two birds, was found in Sipar near Umag

(Cunja 1996, 60–61), vendar pri teh glava ni sploščena. Primerjav na drugih najdiščih jim nismo našli. Lahko da so bile tudi orodje in ne okrasni predmeti.

Najden je bil tudi majhen bronast kraguljček (*t. 5: 16*; detektorska najdba).

## SKLEP

Nakitnih predmetov je bilo najdeno razmeroma veliko, vendar so oblikovno precej preprosti. Prevladujejo večinoma bronasti predmeti, prstani in zapestnice pa so izdelani tudi iz železa (*t. 4: 15–23; 5: 10*). Presečna odsotnost uhanov s košarico, ki so sicer pogosti in značilni za območje jugovzhodnih Alp.

Večina prstanov (*t. 4: 15–26*), uhani s poliedrom (*t. 5: 2–5*), zapestnice (*t. 5: 7–13*) in igle v obliki stilusa (*t. 6: 1–9*) so dolgotrajne oblike, ki se pojavljajo v 4. st. in nadaljujejo v 5. in 6. st. Značilnejši za 4. st. so stekleni obesek v obliki vrčka (*t. 4: 12*), mali uhan s poliedrom (*t. 5: 3*) in del zapestnice z živalsko glavico (*t. 5: 13*).

V 5. in 6. st. lahko datiramo jagodo iz kalcedona (*t. 4: 8*), melonasto jagodo, okrašeno s steklenimi drobci (*t. 4: 7*), železno zapestnico (*t. 5: 10*) in srebrno iglo s ptico (*t. 5: 17*).

Zgodnjerednjeveško obdobje med 7. in 9. st. predstavlja večdelna modra jagoda (*t. 4: 10*) in luničasti uhan z vtisnjnim okrasom (*t. 5: 6*), ki povezuje Tonovcov grad z bližnjo Furlanijo.

Prstani, uhani, zapestnice in igle so tipičen nakit staroselskega prebivalstva, za katerega je značilno, da je preprost oblik in izdelave. Izjema je srebrna igla s ptico (*t. 5: 17*), ki predstavlja edini kakovostnejši kos in je najverjetneje prišla iz vzhodnosredozemskih delavnic.

Tudi nakitni predmeti tako potrjujejo prevladujoč staroselski značaj naselbine. Prisotnost germanskega prebivalstva bi se kazala z večjo količino dragocenih materialov (kot npr. Kranj, Dravljje: Bitenc 2001, kat. 203, 218, 243; Knific 2001, kat. 216, 233).

### 2.1.3 PASNE GARNITURE

#### PASNE GARNITURE 1.–3. ST.

Okov noriško-panonske pasne spona tipa 3B3 po J. Garbschu (*t. 7: 1*) je datiran v prvo polovico 2. st. (Garbsch 1965, 89–90). Ležal je v plasti faze PA 1.

Pasna spona v obliki črke D (*t. 7: 2*, detektorska najdba) je datirana v 3. st. (James 2004, sl. 37: 58).

and is dated to the 6<sup>th</sup> or 7<sup>th</sup> century (Marušić 1995, cat. no. 258). The example from Tonovcov grad belongs among pieces of higher quality and can be assigned to the Byzantine context of the 6<sup>th</sup> and 7<sup>th</sup> century.

Ten bronze and iron pins in the shape of a stylus (*Pls. 5: 18; 6: 1–9*) were found. Most were lying in layers of phase LA 2 (*Pls. 5: 18; 6: 4,7–9*) and mixed layers, only one (*Pl. 6: 6*) was found in the Early Medieval layer.

During the Roman period such pins (*Pls. 5: 18; 6: 1–4*) were used primarily as cosmetic and medical accessories, while during the Late Antiquity they were supposedly part of the attire and were used to pin-up hair or clothes. They also appear in the Germanic world, yet much less. With the Alamanni and the Franks pins with a non-distinct head are slightly more frequent. Pins in the shape of a stylus can approximately be dated between the second half of the 4<sup>th</sup> and the 7<sup>th</sup> century (Möller 1976–1977; Vinski 1980, 21–22; Bierbrauer 1987, 161–162; Riemer 2000, 104).

Iron versions are very rare. In Slovenia besides the six examples from Tonovcov grad (*Pl. 6: 5–9*; building 3: *Pl. 45: 9*) only two undecorated iron pins of this shape are published, one from grave 31 at Lajh in Kranj (Stare 1980, Pl. 16: 7) and one from the settlement at Limberk (Ciglencečki 1985, Pl. 8: 92).

A small bronze pin (*Pl. 5: 19*) with a round head decorated by three incisions was found in a mixed layer. It resembles simple Roman and Late Roman pins, but also the short, mostly silver pins with a round or bi-conical head, which were supposedly, considering their position in graves, used as hair-pins or to fasten veils (Möller 1976–1977, 14–18; Riemer 2000, 106).

Iron pins with a rolled flattened head (*Pl. 6: 10–15*) were lying in a layer of phase LA 1 (*Pl. 6: 13*), in the Early Medieval layer in the outhouse of building 1 (*Pl. 6: 12*), and in layers of phase LA 2 (*Pl. 6: 10–11,14–15*). Their function is unknown. In form they resemble bronze pins with a rolled head from the Late Antique and Early Medieval layers in Koper (Cunja 1996, 60–61) but here the head is not flattened. We did not find parallels at other sites. They could have also been a tool and not objects for decoration.

A small bronze rumbler bell (*Pl. 5: 16*; metal detector find) was also found.

## CONCLUSION

Relatively many pieces of jewellery were found but they are of fairly simple shapes. Bronze objects prevail; finger rings and bracelets can also be made of iron (*Pls. 4: 15–23; 5: 10*). We are surprised by the absence of basket earrings which are generally frequent and characteristics of the area of the Southeastern Alps.

## PASNE SPONE BREZ OKOVA

Veliko je bronastih in železnih pasnih spon brez okova okrogle, ovalne, pravokotne ali D-oblike (*t. 7: 11–27*), nekatere predmete pa bi lahko interpretirali kot trne takšnih spon (*t. 7: 8–10*). Spona (*t. 7: 17*) je bila najdena v plasti faze PA 1, ostale pa v plasteh faze PA 2 (*t. 7: 13–16, 18–27*) in premešani plasti (*t. 7: 11–12*).

Preproste spona so brez znanega konteksta časovno težko opredeljive. Najdejo se že v grobovih 4. st. na prostoru imperija in zunaj njegovih meja, večinoma pa jih lahko postavimo v 5. in 6. st. Na germanskih grobiščih srednje Evrope so grobovi s preprostimi sponami po navadi datirani v najzgodnejšo fazo. Po M. Martinu naj bi uporaba preprostih železnih ali bronastih spon v srednji Evropi prenehala v času med 570–580, ko jih nadomestijo kompleksnejši pasni sestavi (Martin 2000, 188). V staroselskih kontekstih jugovzhodnih Alp se železne spona pogosto pojavljajo med koncem 5. in 7. st. (Vinski 1980, 23–24; Riemer 2000, 163).

## POZNORIMSKE PASNE GARNITURE

## Pasne spona

Okov (*t. 7: 5*) iz bronaste pločevine z dvema luknjama za zakovice je bil najden v plasti faze PA 2. Takšni okovi so se nosili skupaj s polkrožnimi, usločenimi ali pravokotnimi obroči kot del preprostih pasnih garnitur, ki se zelo pogosto pojavljajo v 4. in na začetku 5. st. v Galiji, Panoniji in vzhodnih Alpah (Sommer 1984, 19). E. Keller jih je datiral v drugo polovico 4. st. (Keller 1971, 59–61). P. Pröttel je razširil to datacijo na čas med 330 in začetkom 5. st. (Pröttel 1988, 357–369).

V plasti hodne površine ob stavbi 1 je ležala majhna pasna spona (*t. 7: 6*), katere okov ima samo eno zakovico in je okrašen z žigosanim motivom listov. Podobna pasna spona z motivom listov ali cveta na okovu iz bronaste pločevine je bila najdena na Gradcu pri Prapretnem (Ciglencečki 1994a, sl. 5: 7). Rastlinski okras teh dveh spon lahko primerjamo z žigosanim okrasom okovov pasnih spon v stilu groba iz Unteresiebenbrunn, ki so datirane v čas okrog leta 400 oz. v začetek 5. st. (Tejral 1988a, 36). Spona se med seboj ujemajo tudi po velikosti in obliki obroča (prim. Tejral 1988b, sl. 11 [zgornja vrsta]).

Obroč pasne spona (*t. 7: 4*), najden v plasti faze PA 2, je okrašen s stiliziranimi glavicama delfinov na koncu obroča in z žigosanimi krožci in polkrožci. Po obliki spada med enostavne pasne garniture, ki so se razvile iz garnitur s klinastim vrezom, posebno iz tipa Vieuxville. Enostavne pasne garniture so nosili predvsem v severni Galiji in neposredni okolici že od konca 4. st., vendar večinoma okrog leta 400 ter v prvi polovici 5. st. (Böhme 1974, 89–91; 1986, 473, 495; Sommer 1984, 110). Sam okras obroča – žigosanje – je sicer značilen za pasne gar-

Most of the finger rings (*Pl. 4: 15–26*), earrings with a polyhedron (*Pl. 5: 2–5*), bracelets (*Pl. 5: 7–13*), and pins in the shape of a stylus (*Pl. 6: 1–9*) are long-lasting shapes which appear in the 4<sup>th</sup> century and continue into the 5<sup>th</sup> and 6<sup>th</sup> century. More characteristic for the 4<sup>th</sup> century are a jug-shaped glass pendant (*Pl. 4: 12*), a small earring with a polyhedron (*Pl. 5: 3*), and a piece of a bracelet with a small animal head (*Pl. 5: 13*).

A bead made of chalcedony (*Pl. 4: 8*), a melon-shaped bead decorated by glass fragments (*Pl. 4: 7*), an iron bracelet (*Pl. 5: 10*), and a silver pin with a bird (*Pl. 5: 17*) can be assigned to the 5<sup>th</sup> and 6<sup>th</sup> century.

A segmented blue bead (*Pl. 4: 10*) and a crescent-shaped earring with an impressed decoration (*Pl. 5: 6*), which connects Tonovcov grad with the nearby Friuli, represent the Early Medieval period between the 7<sup>th</sup> and the 9<sup>th</sup> century.

Rings, earrings, bracelets, and pins are typical jewellery of the autochthonous inhabitants and are of characteristic simple shapes and manufacturing. An exception is a silver pin with a bird (*Pl. 5: 17*) which represents the only piece of higher quality and most probably originates from eastern Mediterranean workshops.

Thus the jewellery also confirms the prevailing autochthonous character of the settlement. The presence of the German population would have revealed itself through a greater amount of precious materials (as for example at Kranj, Dravljje: Bitenc 2001, cat. nos. 203, 218, 243; Knific 2001, cat. nos. 216, 233).

## 2.1.3 BELT SETS

BELT SETS OF 1<sup>ST</sup>-3<sup>RD</sup> CENTURY

A plate of a Norico-Pannonian belt buckle of type 3B3 according to J. Garbsch (*Pl. 7: 1*) is dated to the first half of the 2<sup>nd</sup> century (Garbsch 1965, 89–90). It was lying in a layer of phase LA 1.

A D-shaped belt buckle loop (*Pl. 7: 2*, metal detector find) is dated to the 3<sup>rd</sup> century (James 2004, Fig. 37: 58).

## BELT BUCKLES WITHOUT BUCKLE PLATE

There are many bronze and iron belt buckle loops without a buckle plate of a round, oval, rectangular or D-shape (*Pl. 7: 11–27*), while several objects could be interpreted as tongues of such buckles (*Pl. 7: 8–10*). A buckle (*Pl. 7: 17*) was found in a layer of phase LA 1, the rest were lying in layers of phase LA 2 (*Pl. 7: 13–16, 18–27*) and a mixed layer (*Pl. 7: 11–12*).

Simple buckles are difficult to define without a closed context. They are found already in the graves of the 4<sup>th</sup> century within the Empire and across its borders but are mostly assigned to the 5<sup>th</sup> and 6<sup>th</sup> century.



niture z žigosanim okrasom, ki so enostavnim sočasne in razširjene na alamanskem območju jugozahodne Nemčije v prvi polovici 5. st. (Böhme 1974, 91; 1986, 498).

Trn (*t. 7: 7*) je pripadal eni od poznorimskih pasnih spon (prim. Bullinger 1969, sl. 57: 7).

Obroč poznorimske pasne spona (*t. 7: 3*) z nasproti si stoječima živalskima (delfinjima) glavicama na sredini obroča in posebej izdelano osjo je bil najden v stavbi 1 v zgodnjedneveški plasti. Pripada široko razprostranjenim preprostim pasnim garnituram, ki se kombinirajo s pravokotnimi, krilatimi ali predrtimi okovi in spadajo v čas tik pred pojavom garnitur s klinastim vrezom konec 4. st. (Böhme 1974, 71, 83; 1986, 473).

### Pasni okovi

Krilati okovi (*t. 8: 9-10*), ki so bili v 4. st. – najkasneje od Konstantina I. dalje – del poznorimske vojaške in uradniške noše, so sestavljali preproste pasne garniture (s pasnimi sponami s krilatimi ali predrtimi okovi), redko garniture s klinastim vrezom (Keller 1971, 67; Böhme 1986, 501).

Majhen okrogel okov (*t. 8: 11*), okrašen s koncentričnimi krožci in izrastki, je imel verjetno na mestu manjkajočega četrtega izrastka oblikovano zanko in je bil lahko pritrjen na pas katere od poznorimskih pasnih garnitur (prim. npr. Bullinger 1969, sl. 29: 2; 37: 2; 39: 1). Podobno funkcijo je lahko imel majhen kvadraten okov z zanko (*t. 8: 13*), izdelan iz tanke bronaste pločevine.

Nenavaden je podolgovat okov s privzdignjenim osrednjim delom, okrašen v tehniki klinastega vresa (*t. 8: 15*), za katerega še nismo našli primerjave. Lahko ga širše uvrstimo v čas garnitur s klinastim vrezom, torej konec 4. in začetek 5. st. (Böhme 1974, 91; Pflaum 2002, 272).

Majhen pravokoten bronast okov z narebrenim robom (*t. 8: 12*) je morda prav tako spadal k poznorimski pasni opremi, čeprav ni jasno, kako je bil pritrjen, saj nima ohranjenih lukenj za zakovice.

Končni okov (*t. 8: 16*) s trikotnimi izrastki je V. Pflaum glede na primerjave z germanskimi izpeljankami pasnih spon s predrtim okovom, ki so se pojavljale v Podonavju, na Balkanu in kavkaško–južnoruskem prostoru, povezala z vzhodnorimskim krogom in ga previdno datirala v drugo polovico 5. st. (Pflaum 2000, 84–86).

Poškodovan bronast gumb (*t. 8: 14*) pasne garniture je ležal v plasti, ki je predstavljala zunanjo hodno površino stavbe 1. Dva enaka gumba sta bila najdena v grobu 0b grobišča Servis v Pomarolu v severni Italiji. Grob je z novčnimi najdbami datiran v dvajseta ali trideseta leta 5. st. in pripisan posadki federatov (Cavada 2002, 151–155, t. X; XI).

Z izjemo krilatega okova (*t. 8: 10*), ki je bil najden v plasti notranje hodne površine stavbe 1 iz faze PA 2, so vsi našeti okovi detektorske najdbe.

Pravokoten jermenski zaključek iz dveh plasti bronaste pločevine (*t. 8: 17; sl. 2.4*) je okrašen z bisernim

On the Germanic cemeteries of central Europe graves with simple buckles are usually assigned to the earliest phase. According to M. Martin the use of simple iron or bronze buckles ceased in central Europe between 570 and 580, when they were replaced by more complex belt sets (Martin 2000, 188). In autochthonous contexts of the Southeastern Alps iron buckles frequently appear between the end of the 5<sup>th</sup> and the 7<sup>th</sup> century (Vinski 1980, 23-24; Riemer 2000, 163).

## LATE ROMAN BELT SETS

### Belt buckles

A buckle plate (*Pl. 7: 5*) made of bronze sheet with two holes for rivets was found in a layer of phase LA 2. Such buckle plates were worn together with semicircular, kidney-shaped or rectangular loops as parts of plain belt sets, which frequently appear in the 4<sup>th</sup> and the beginning of the 5<sup>th</sup> century in Gallia, Pannonia, and the eastern Alps (Sommer 1984, 19). E. Keller dated them to the second half of the 4<sup>th</sup> century (Keller 1971, 59-61). P. Pröttel widened this dating to the time between 330 and the beginning of the 5<sup>th</sup> century (Pröttel 1988, 357-369).

In the walking surface of building 1 a small belt buckle (*Pl. 7: 6*) was found, the plate of which has only one rivet and is decorated by a stamped motif of leaves. A similar belt buckle with the motif of leaves or a flower on the plate made of bronze sheet was found at Gradec near Prapretno (Ciglencečki 1994a, Fig. 5: 7). Plant decoration of these two buckles can be compared to the stamped ornament of belt buckle plates in the style of the grave from Untersiebenbrunn, which are dated to around 400 or to the beginning of the 5<sup>th</sup> century (Tejral 1988b, 36). Buckles match also in size and shape of the loop (cf. Tejral 1988a, Fig. 11 [the upper row]).

A belt buckle loop (*Pl. 7: 4*) found in a layer of phase LA 2 is decorated by stylised dolphin heads at the end of the loop and by stamped circles and semicircles. Considering the shape it belongs among simple belt sets (Einfache Gürtelgarnituren) which developed from chip carved beltsets, especially from type Vieuxville. Simple belt sets were primarily worn in northern Gaul and its immediate surroundings from the end of the 4<sup>th</sup> century onwards, but mostly around 400 and the first half of the 5<sup>th</sup> century (Böhme 1974, 89-91; 1986, 473, 495; Sommer 1984, 110). The decoration of the loop – stamping – is otherwise typical for belt sets with a stamped decoration which are contemporary to simple belt sets and are spread over the Alemanni area of the southwestern Germany in the first half of the 5<sup>th</sup> century (Böhme 1974, 91; 1986, 498).

A tongue (*Pl. 7: 7*) belonged to one of the Late Roman belt buckles (cf. Bullinger 1969, Fig. 57: 7).

A loop of the Late Roman belt buckle (*Pl. 7: 3*) with opposite facing animal (dolphin) heads in the middle of



Sl. 2.4: Karta razprostranjenosti pravokotnih pasnih zaključkov in spon s figuralnim okrasom in bisernim nizom (kot t. 8: 17).  
Fig. 2.4: Distribution of rectangular strap ends with figural decoration and pearl border (similar to Pl. 8: 17).

nizom in reliefnim prizorom lova na jelena na obeh straneh. Najden je bil v plasti faze PA 2. Jermenske zaključke z bisernim nizom in figuralnim okrasom lahko najdemo na grobiščih ob donavskem limesu in v Panoniji, primerjave motivu in izvedbi pa tudi v okrasu skrinjic iz ženskih grobov na istem prostoru. Posebno pri najkakovostnejših kosih je očitno, da predstavljajo del vojaške, najverjetneje častniške noše konec 4. in na začetku 5. st. (Ciglencečki, Milavec 2009, 179, 181, t. 1: 6; Milavec 2011).

#### POZNOANTIČNE PASNE GARNITURE

##### Pasne spone

Mala srebrna pasna spona (t. 8: 8, detektorska najdba) spada med enodelne mediteranske pasne spone 6. in 7. st., ki imajo po navadi pravokoten obroč, tonovski pa je ovalen. Tipološko spada med starejše, saj po obliki spominja še na poznorimske spone s trikotnim okovom.

the loop and a specially made axis was found in building 1, in the Early Medieval layer. It belongs among the widely distributed belt sets which are combined with rectangular, winged or perforated buckle plates and belong to the time immediately before the appearance of chip carved belt sets at the end of the 4<sup>th</sup> century (Böhme 1974, 71, 83; 1986, 473).

##### Belt fittings

Winged fittings (Pl. 8: 9-10) which were in the 4<sup>th</sup> century – from Constantine I onwards – part of the Late Roman military and administrative attire composed plain belt sets with belt buckles with winged or perforated buckle plates, rarely chip carved belt sets (Keller 1971, 67; Böhme 1986, 501).

A small round fitting (Pl. 8: 11) decorated by concentric rings and projections probably had a loop formed at the point of the missing fourth projection. It could have been attached to a belt of one of the Late Roman

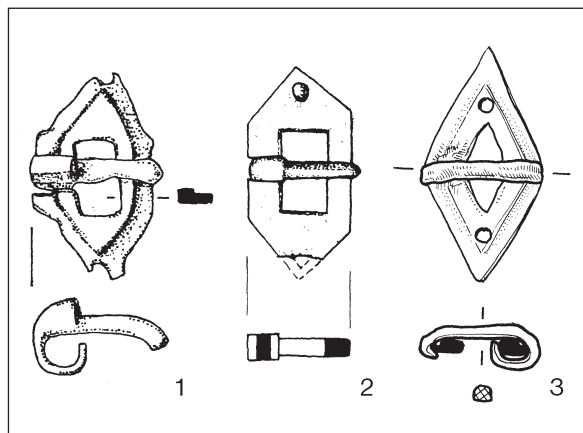

Sl. 2.5: Rombaste pasne spone. 1 Kranj, Lajh (po Stare 1980, t. 77: 12), 2 Klističi pri Tinjanu (po Šonje 1980–1981, t. I: 3), 3 Tonovcov grad (t. 8: 7). 1–2 bron, 3 bron in železo. M. = 1:1. Fig. 2.5: Rhomb-shaped belt buckles. 1 Kranj, Lajh (after Stare 1980, Pl. 77: 12), 2 Klističi near Tinjan (after Šonje 1980–1981, Pl. I: 3), 3 Tonovcov grad (Pl. 8: 7). 1–2 bronze, 3 bronze and iron. Scale = 1:1.

Datiramo jo lahko v drugo polovico 6. st. (Vinski 1967, 41–50; Vinski 1980, 24). Natančne primerjave ji nismo našli, zelo primerljivi, tudi srebrni primerki pa so dokaj pogosti na kranjskem grobišču Lajh (Stare 1980, t. 30: 6; 69: 10; 91: 4; 110: 7; 121: 4).

K pasnim sponam 6. st. spada tudi masiven bronast ščitast trn (t. 8: 6, detektorska najdba; prim. Bitenc 2001, kat. 185, 242).

Majhne spone s pravokotno oblikovanim obročem (t. 8: 2–5) so verjetno zapenjale obuvala ali torbice. Ležale so v plasti zunanje hodne površine stavbe (t. 8: 4) in plasti faze PA 2 (t. 8: 2), druge pa v premešani plasti. Ena je okrašena z znakom X, tri so brez okrasa. Časovno so postavljene večinoma v sredino in drugo polovico 6. st. in so pogoste na germanskem območju (Losert, Pleterski 2003, 214; Bierbrauer 1987, 168).

Bronasta pasna spona rombaste oblike z železnim trnom (t. 8: 7; sl. 2.5: 3), ki je bila najdena v ruševini, ima dobro primerjavo v grobu 253 na kranjskem grobišču na Lajhu (Stare 1980, t. 77: 12; sl. 2.5: 1). Obe sponi imata presek v obliki črke L in luknji za zakovici. Kranjska spona ima ščitast trn, zato lahko umestimo obe v 6. st. Zelo podobna spona je bila najdena tudi v grobu 8 v Klističih pri Tinjanu v Istri, ki je s tremi sponami datiran v drugo polovico 6. st. (Šonje 1980–1981, t. I: 3; sl. 2.5: 2). Rombasta spona je interpretirana kot spona torbice (Šonje 1980–1981, t. II: 9; Ibler 1991, 142).

V majhen bronast pravokoten okvir okova spone (t. 8: 1, detektorska najdba) so bili nekoč vstavljeni kamni ali stekla, ki so izpadli. Spona spada okvirno med zgodnjebizantinske mediteranske spone s konca 5. in začetka 6. st., ki se pojavljajo v različicah s polkrožnimi, ledvičastimi in pravokotnimi okovi ter z več oblikami obročev, skupen pa jim je okras vložnih poldragih

belt sets (cf. e.g. Bullinger 1969, Figs. 29: 2; 37: 2; 39: 1). A small square fitting with a loop (Pl. 8: 13) made of thin bronze sheet could have had a similar function.

An elongated fitting with a raised central part (belt-slide) decorated in the technique of chip carving (Pl. 8: 15) is unusual and its parallels have yet not been found. It can broadly be assigned to the time of chip carved belt sets, i.e. to the end of the 4<sup>th</sup> and the beginning of the 5<sup>th</sup> century (Böhme 1974, 91; Pflaum 2002, 272).

A small rectangular bronze fitting with a ribbed edge (Pl. 8: 12) could have possibly also belonged to a Late Roman belt set, although it is not clear how it was attached since the holes for rivets are not preserved.

The end fitting (Pl. 8: 16) with triangular projections was by V. Pflaum seen as eastern Roman and with hesitation dated to the second half of the 5<sup>th</sup> century (Pflaum 2000, 84–86). It was done on the basis of comparisons to German versions of belt buckles with perforated plates which appear in the Danubian region, in the Balkans, and in the area of Caucasus and southern Russia.

A damaged bronze button (Pl. 8: 14) of a belt set was found in the layer representing the outer walking surface of building 1. Two identical buttons were found in grave 0b of the cemetery Servis in Pomarolo in northern Italy. The grave is due to coin finds dated to the 420s or 430s and is assigned to a crew of federati (Cavada 2002, 151–155, Pls. X; XI).

All the above enumerated fittings are metal detector finds with the exception of the winged fitting (Pl. 8: 10) which was found in the inner walking surface of building 1 from phase LA 2.

A rectangular strap end made of two layers of bronze sheet (Pl. 8: 17; Fig. 2.4) is decorated by a pearl border and an embossed depiction of stag hunt on both sides. It was found in a layer of phase LA 2. Strap ends with a pearl border and figural decoration can be found on the cemeteries along the Danubian limes and in Pannonia, parallels for the motif and the making are found on casket decoration from female graves of the same area. Especially the high quality pieces obviously indicate that these are parts of military, probably officer's attire of the end of the 4<sup>th</sup> and the beginning of the 5<sup>th</sup> century (Ciglencečki, Milavec 2009, 179, 181, Pl. 1: 6; Milavec 2011).

## LATE ANTIQUE BELT SETS

### Belt buckles

A small silver belt buckle (Pl. 8: 8, metal detector find) belongs among single-piece Mediterranean belt buckles of the 6<sup>th</sup> and 7<sup>th</sup> century. These usually have a rectangular loop, while the one from Tonovcov grad is oval. Typologically it belongs among the earlier ones since in its form it resembles the Late Roman belt

kamnov ali steklenih ploščic v okovu. Tovrstne spone v dragocenih kovinah, z odebeljenimi obroči in močno presegajočimi trni se pojavijo v Evropi v hunskem obdobju, značilne pa so za celoten horizont predvsem bogatih grobov nomadskih in vzhodnogermanskih ljudstev iz sredine 5. st.

V drugi polovici 5. st. in začetku ali prvi polovici 6. st. so te spone v nekoliko spremenjenih oblikah pogoste v merovinški Evropi ter celotnem Sredozemlju, uporabljala naj bi jih različna germanska ljudstva (Vzhodni in Zahodni Goti, Vandali itd.) in Romani, pripisujejo pa jim večinoma vzhodnorimski izvor (Böhme 1994; Kazanski 1994). V Sloveniji so bile najdene spone tega tipa v Emoni (Slabe 1978, sl. 5), na Zidanem gabru nad Mihovim in Gradcu pri Veliki Strmici (Ciglencečki 2008, sl. 13: 12; 14: 9). Tonovškemu okovu oblikovno najbližji (majhen pravokoten okov z dvema vmesnima prekatoma ali okroglim poljem v sredini) je najden na Korinjskem hribu (vmesni prekati so morda izpadli: Ciglencečki 1994a, t. 9: 10). Dve sponi z okovom brez vmesnih prekatov sta bili najdeni v grobovih 12 in 238 na kranjskem Lajhu (Stare 1980, t. 11: 1; 73: 13), še en okov pa v grobu 21 na Rifniku (Bolta 1981, t. 4: 11).

Širše primerjave kažejo, da se v grobovih pojavljata po dve sponi, od katerih je večja interpretirana kot pasna, manjša pa kot spona za pripenjanje spathe: Rakovčani, grob 33 (Miletić 1970, t. IV: 33), Weimar, grob 31 (Schmidt 1970, 80–81), Flonheim, grob 9 (Menghin 1983, kat. 44), Capraia pri Livornu (Ciampoltrino 1991, 54–59), precej podobne po okrasu, vendar večje, pa še v grobu 15 v Deeresheimu (Böhme 1994, sl. 8A) in grobu 21 v Petersfingerju v Angliji (Böhme 1994, sl. 12).

V nekaterih primerih, ko sta bili v grobu najdeni dve sponi različnih oblik, so manjše prepoznane kot spone torbic (npr. grob 8, Klističi; Šonje 1980–1981, t. II). Glede na velikost (d. in š. pribl. 3 cm) in krhkost tonovške spone menimo, da gre tudi tu za spono torbice.

### Pasni okovi

Masiven bronast pasni okov (t. 8: 19) je bil najden v plasti faze PA 2.

Pasni jeziček (t. 8: 20) iz srebrne pločevine, najden v plasti zunanje hodne površine stavbe, spada med bizantinskodobne zaključke jermenov, ki so viseli s pasu. Garniture so bile sestavljene iz velikega števila jermenov z zaključki, ki so bili pogosto srebrni ali celo zlati, večinoma tudi okrašeni (Wamser 2004, 283–285). Tonovski zaključek ni okrašen, vendar je dovolj tipičen, da ga lahko uvrstimo v sklop omenjenih pasnih garnitur konca s 6. in iz 7. st., ki so jih med drugim radi uporabljali tudi Avari. Vrsta pasnih garnitur, h kateri bi lahko spadal, je postavljena v zgodnje avarsko obdobje (horizont 1 po Breuerju; Breuer 2005, 45–49), ki je datirano v čas približno med 568 in 620/630. Delno

buckles with a triangular plate. It can be dated to the second half of the 6<sup>th</sup> century (Vinski 1967, 41–50; Vinski 1980, 24). Precise analogies could not be found, yet very comparable, also silver examples are quite frequent at the cemetery Lajh in Kranj (Stare 1980, Pls. 30: 6; 69: 10; 91: 4; 110: 7; 121: 4).

A massive bronze shield-shaped tongue (Pl. 8: 6, metal detector find) also belongs to belt buckles of the 6<sup>th</sup> century (cf. Bitenc 2001, cat. nos. 185, 242).

Small buckles with a rectangular loop (Pl. 8: 2–5) were probably used to fasten footwear or purses. They were found in the outer walking surface of the building (Pl. 8: 4) and in a layer of phase LA 2 (Pl. 8: 2), others in mixed layers. One is decorated by symbol X, three are unornamented. They are mostly dated to the middle or the second half of the 6<sup>th</sup> century and are also frequent in the German territory (Losert, Pleterski 2003, 214; Bierbrauer 1987, 168).

A bronze belt buckle of rhombic shape with an iron tongue (Pl. 8: 7; Fig. 2.5: 3) that was found in the destruction layer has a good analogy in grave 253 at the cemetery Lajh in Kranj (Stare 1980, Pl. 77: 12; Fig. 2.5: 1). Both buckle loops have an L-shape cross section and two holes for rivets. The buckle from Kranj has a shield-shaped tongue which could place both buckles into the 6<sup>th</sup> century. A very similar belt buckle was found in grave 8 in Klističi near Tinjan in Istria, which is – with three other buckles – dated to the second half of the 6<sup>th</sup> century (Šonje 1980–1981, Pl. I: 3; Fig. 2.5: 2). The rhombic buckle is interpreted as a purse buckle (Šonje 1980–1981, Pl. II: 9; Ibler 1991, 142).

Gemstones or glass which fell out were once inserted into the small bronze rectangular frame of the buckle plate (Pl. 8: 1, metal detector find). The buckle belongs among the Early Byzantine Mediterranean belt buckles of the end of the 5<sup>th</sup> and the beginning of the 6<sup>th</sup> century. These appear in variants with semicircular, kidney-shaped, and rectangular plates and with several loops hapes. Common to them all is the decoration of inserted cut semi-precious stones or glass in the buckle plate. Such belt buckles made of precious metals, with thickened loops and with a strongly surpassing tongues appear in Europe in the period of the Huns and are typical for the entire horizon of primarily rich graves of Nomadic and Eastern Germanic peoples of the middle of the 5<sup>th</sup> century.

In the second half of the 5<sup>th</sup> and the beginning or the first half of the 6<sup>th</sup> century in a slightly altered form such buckles are frequent in the Merovingian Europe and the entire Mediterranean and were supposedly used by various Germanic peoples (Eastern and Western Goths, Vandals etc.) and by the Romans, while they are mostly assigned Eastern Roman origin (Böhme 1994; Kazanski 1994). In Slovenia belt buckles of this type were found in Emona (Slabe 1978, Fig. 5), Zidani gaber above Mihovo, and Gradec near Velika Strmica (Ciglencečki 2008, Figs. 13: 12; 14: 9). The closest in form

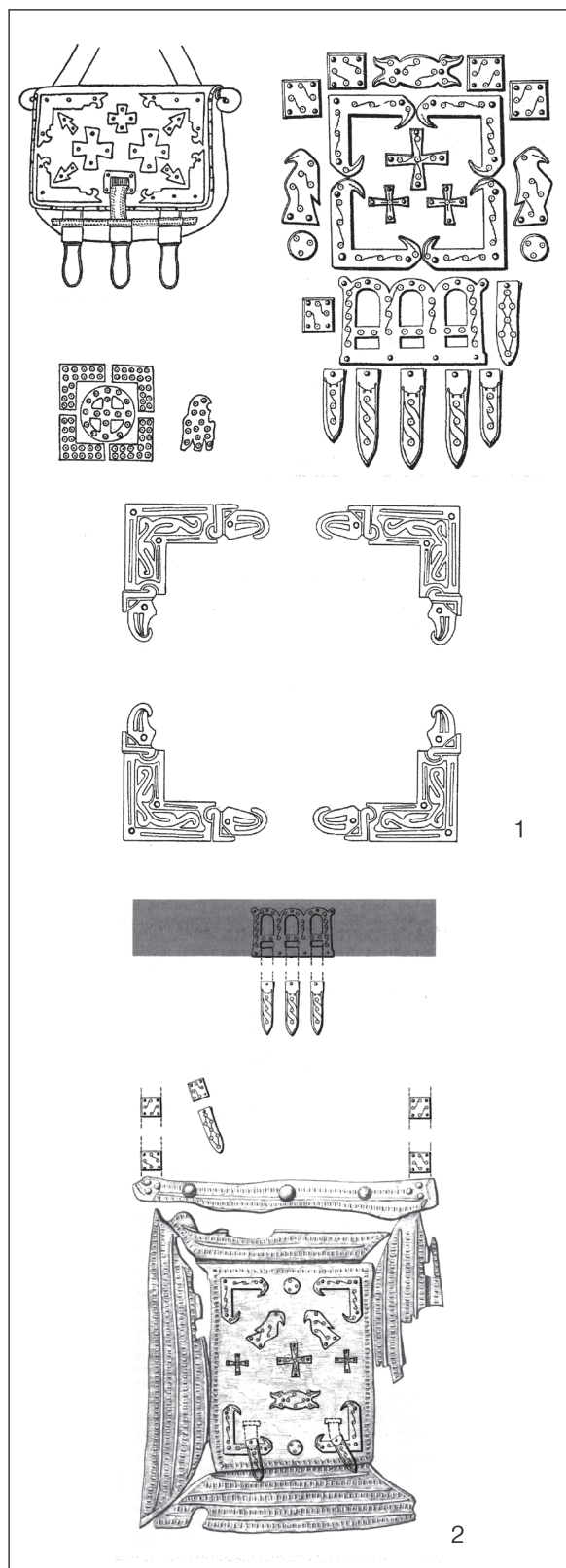

Sl. 2.6: Rekonstrukcije torbic. 1 Buissière, Spontin, Essigny-le-Petit, Wittislingen (po Werner 1950, sl. 25); 2 Essigny-le-Petit (po Martin 1991, sl. 81).

Fig. 2.6: Reconstructions of purses. 1 Buissière, Spontin, Essigny-le-Petit, Wittislingen (after Werner 1950, Fig. 25); 2 Essigny-le-Petit (after Martin 1991, Fig. 81).

(a small rectangular buckle plate with two partitions or a round field in the centre) to the buckle plate from Tonovcov grad was found at Korinjski hrib (partitions could have fallen out: Ciglencečki 1994a, Pl. 9: 10). Two buckle plates without partitions were found in graves 12 and 238 at the cemetery Lajh in Kranj (Stare 1980, Pls. 11: 1; 73: 13) and another one in grave 21 at Rifnik (Bolta 1981, Pl. 4: 11).

Broader comparisons show that two buckles appear in every grave, the bigger of the two is interpreted as a belt buckle, while the smaller one was used to fasten the spatha: Rakovčani, grave 33 (Miletić 1970, Pl. IV: 33), Weimar, grave 31 (Schmidt 1970, 80-81), Flonheim, grave 9 (Menghin 1983, cat. no. 44), Capraia near Livorno (Ciampoltrino 1991, 54-59), and quite similar in decoration but bigger also in grave 15 in Deeresheim (Böhme 1994, Fig. 8A), and grave 21 in Petersfinger in England (Böhme 1994, Fig. 12).

Sometimes when a grave reveals two buckles of various forms smaller buckles are recognised as purse buckles (e.g. grave 8, Klističi; Šonje 1980-1981, Pl. II). Considering the size (l. and w. ca. 3 cm) and fragility of the buckle plate from Tonovcov grad we believe that this is also a purse buckle.

### Belt fittings

A massive bronze belt fitting (Pl. 8: 19) was found in a layer of phase LA 2.

A strap end (Pl. 8: 20) made of silver sheet and found in the outer walking surface of the building belongs among the Byzantine period strap ends hung from the belt. Belt sets were assembled from a large number of straps with strap ends which are often silver or even golden and are mostly also decorated (Wamser 2004, 283-285). The strap end from Tonovcov grad is not decorated but is typical enough to allow the assignment among the above mentioned belt sets of the end of the 6<sup>th</sup> and 7<sup>th</sup> century, which were also favourite with the Avars. The type of belt sets, to which it could belong, is dated to the early Avar period (horizon 1 according to Breuer; Breuer 2005, 45-49), i.e. approximately between 568 and 620/630. Partly comparable golden strap end was found in the so-called 'golden grave' from the mid-6<sup>th</sup> century at the cemetery Lajh in Kranj (Knific 2001, cat. no. 216; Bras Kernel 2002, 127-128). Comparable, bigger and decorated strap ends were found at Sadovec, the author repeats Werner's dating into the last third of the 6<sup>th</sup> and the beginning of the 7<sup>th</sup> century (Uenze 1992, 192).

An L-shaped bronze ornamental fitting (Pl. 8: 18) was lying in a layer of phase LA 2. Its analogies are found at cemeteries of the 6<sup>th</sup> century. Similar fittings were found in graves 253 and 238 at the cemetery Lajh in Kranj (Stare 1980, Pl. 77: 8), in grave 21 at Rifnik (Bolta 1981, Pl. 4: 9), in Lombard (?) grave 24b at Brunn

primerljiv zlat pasni zaključek je bil najden v tako imenovanem "zlatem grobu" iz sredine 6. st. na kranjskem grobišču na Lajhu (Knific 2001, kat. 216; Bras Kernel 2002, 127–128). Primerljivi, večji in okrašeni pasni zaključki so bili najdeni na Sadovcu, avtorica povzema Wernerjevo datacijo v zadnjo tretjino 6. in začetek 7. st. (Uenze 1992, 192).

Bronasti okrasni okov v obliki črke L (*t.* 8: 18) je ležal v plasti faze PA 2. Primerjave ima na grobiščih 6. st. Podobni okovi so bili najdeni v grobovih 253 in 238 na kranjskem grobišču Lajh (Stare 1980, t. 77: 8), v grobu 21 na Rifniku (Bolta 1981, t. 4: 9), v langobardskem (?) grobu 24b v kraju Brunn am Gebirge v Spodnji Avstriji (Aspöck, Stadler 2003, t. 19: 5–7), v grobu 8 v Klističih pri Tinjanu v Istri (Šonje 1980–1981, t. II: 9) in v ženskem grobu 5 v S. Cristini di Lozio (Riemer 2000, t. 40: 15–17).

Primerjave kažejo, da so takšni okovi krasili usnjene torbice, ki so se zapenjale z majhnimi sponami. Najbolj izpovedne so primerjave s sicer približno sto let mlajših najdišč v Belgiji in severni Franciji (Werner 1950, 52–57; sl. 25; Martin 1991, sl. 81). Na rekonstrukcijah torbic je lepo vidno, da so bile lahko okovane s po enim okovom v obliki črke L v vsakem vogalu (*sl.* 2.6).

Odkrit je bil tudi okov torbice (*t.* 8: 21), kakršni so bili pogosti v 6. st. (Vinski 1980, 26).

#### ZGODNJESREDNJEVEŠKE PASNE GARNITURE

Uliti bronast pasni okov (*t.* 8: 23), ki je ležal v žganinski plasti faze PA 2 v stavbi 1, spada k avarskodobnim pasnim garnituram, najverjetneje poznega avarskega obdobja (horizont 5 po Breuerju). Poznoavarsko obdobje traja približno med 680–793, ta pasni okov je datiran verjetno v začetek 8. st. (pribl. 730; Breuer 2005, 69–75).

Bronast in pozlačen uliti pasni jeziček (*t.* 8: 22, detektorska najdba) spada med zgodnjekarolinške predmete, datirane okrog leta 800. Primerjave mu lahko najdemo v Istri, na primer v Siparu pri Umagu, kjer je podoben zaključek datiran v 9. st. (Giesler 1974; Marušić 1995, kat. 489, sl. 132).

#### SKLEP

Poznorimska pasna oprema (*t.* 7: 3–7; 8: 9–17) je dobro zastopana in predstavlja poznoantično fazo 1 (druga polovica 4. in začetek 5. st.), ki v arhitekturi sicer ni dobro opazna.

Pravokotni jermenski zaključek (*t.* 8: 17; *sl.* 2.4) s figuralno upodobitvijo se navezuje na podobne najdbe vojaške noše ob podonavskem limesu in Panoniji okrog leta 400. Tudi pasna spona z žigosanim ornamentom (*t.* 7: 6) prav tako lahko sega še v 5. st. Nenavadnima končnemu (*t.* 8: 16) in podolgovatemu okovu s privzdi-

am Gebirge in Lower Austria (Aspöck, Stadler 2003, Pl. 19: 5–7), in grave 8 at Klističi near Tinjan in Istria (Šonje 1980–1981, Pl. II: 9), and in female grave 5 at S. Cristina di Lozio (Riemer 2000, Pl. 40: 15–17).

Comparisons reveal that such fittings decorated leather purses which were fastened by small buckles. The most revealing are comparisons with otherwise approximately 100 years younger sites in Belgium and northern France (Werner 1950, 52–57; Fig. 25; Martin 1991, Fig. 81). Reconstructions of the purses clearly show that they could have been fitted by one L-shaped fitting in each corner (*Fig.* 2.6).

A fitting of a purse (*Pl.* 8: 21) was also discovered, such fittings are frequent in the 6<sup>th</sup> century (Vinski 1980, 26).

#### EARLY MEDIEVAL BELT SETS

A cast bronze belt fitting (*Pl.* 8: 23) found in a layer of burnt remains of phase LA 2 within building 1 belongs to the Avar period belt sets, most probably of the Late Avar period (horizon 5 according to Breuer). The Late Avar period lasts approximately from 680 to 793, this belt fitting is dated probably to the beginning of the 8<sup>th</sup> century (ca. 730; Breuer 2005, 69–75).

A bronze and gilt strap end (*Pl.* 8: 22, metal detector find) belongs among the Early Carolingian objects, dated around 800. Its parallels are found in Istria, for example in Sipar near Umag, where a similar strap end is dated to the 9<sup>th</sup> century (Giesler 1974; Marušić 1995, cat. no. 489, Fig. 132).

#### CONCLUSION

Late Roman belt sets (*Pls.* 7: 3–7; 8: 9–17) are quite numerous and represent the first Late Antiquity phase (LA 1: second half of the 4<sup>th</sup> and the beginning of the 5<sup>th</sup> century), which is not well noticeable in the architecture.

The rectangular strap end (*Pl.* 8: 17; *Fig.* 2.4) with a figural depiction is connected to similar finds of military attire along the Danubian limes and Pannonia around 400. The belt buckle with a stamped ornament (*Pl.* 7: 6) can also reach into the 5<sup>th</sup> century. We were unable to find good parallels for the unusual end fitting (*Pl.* 8: 16) and an elongated fitting with a raised central part (belt-slide; *Pl.* 8: 15) but they also belong to the time around 400. Other Late Roman finds, which include pottery (see chapter. 4.1) and coins (see chapter 5), are also well represented at Tonovcov grad. But it is the belt set remains that point to the presence of a military garrison at the settlement in the time after the abandonment of Claustra (see Tonovcov grad. Settlement remains and interpretation, chapter 1.5).

gnjenim srednjim delom (*t.* 8: 15) nam ni uspelo najti dobrih primerjav, segata pa prav tako v čas okrog leta 400. Tudi druge poznorimske najdbe, to so keramika (glej pogl. 4.1) in novci (glej pogl. 5), so na Tonovcovem gradu dobro zastopane. Prav ostanki pasov pa kažejo na prisotnost vojaške posadke v postojanki v času po opustitvi Klavster (glej Tonovcov grad. Naselbinski ostanki in interpretacija, pogl. 1.5).

Čas od konca 5. do začetka 7. st. (faza PA 2) predstavljajo železne pasne spono brez okova (*t.* 7: 11–16, 18–27), ki so značilne za staroselska najdišča. Manjše spono (*t.* 8: 2–5) večkrat srečamo na merovinških grobiščih. Med zgodnjebizantinske predmete spada okvir okova male zgodnjebizantinske mediteranske spono (*t.* 8: 1), ki bi jo lahko postavili v konec 5. ali začetek 6. st. V ta čas in še pozneje lahko spada tudi okov torbice v obliki črke L (*t.* 8: 18).

Spono torbice predstavlja tudi mala rombasta spona (*t.* 8: 7; *sl.* 2.5) iz 6. st., lahko celo njegove druge polovice. Druga polovica 6. st. je zastopana še z malo srebrno mediteransko spono (*t.* 8: 8). Jermenski zaključek iz srebrne pločevine (*t.* 8: 20) lahko predstavlja bizantinsko ali celo avarsko prisotnost konca 6. in začetka 7. st.

Dva zgodnj srednjeveška kosa spadata v čas po opustitvi poznoantične naselbine. Okov (*t.* 8: 23) je bil sicer najden v plasti faze PA 2 (SE 11), datirane v konec 5. in 6. st., vendar je najverjetneje zdrsel iz višje ležeče zgodnj srednjeveške plasti (SE 10), ki je predvsem s štiridelno jagodo (*t.* 4: 10) datirana v čas okrog leta 800. Tipološko je okov starejši, vendar je za avarskodobne predmete v Sloveniji značilno, da se pojavljajo v kasnejših kontekstih, domnevno kot sledovi tistih, ki so se s plenom vrnili iz frankovsko-avarskih vojn konec 8. st. (Pleterski 1999, 370). Karolinškodobni zaključek (*t.* 8: 22) je naključna najdba, njegova povezava z zgodnj srednjeveško poselitvijo v stavbi je vprašljiva (glej Tonovcov grad. Naselbinski ostanki in interpretacija, pogl. 2.2.4).

## 2.1.4 OROŽJE

### OROŽJE IN OPREMA JEZDECA IN KONJA 1.–3. ST.

V plasti faze PA 2 je ležal bronast členek z železno zakovico (*t.* 9: 1), del rimskodobnega verižnega oklepa tipa *lorica hamata* (Van der Sanden 1993, *sl.* 9).<sup>8</sup>

Okrogel okrašen bronast okov (*t.* 9: 2) je krasil jermene konjske oprave (prim. Deimel 1987, 97, *t.* 84: 13).

Slabo ohranjeni železni ostrogi (*t.* 9: 3) ni mogoče določiti natančne oblike, še najbolj ji je podoben polizdelek ostroge s Štalenske gore na Koroškem (Dolenz 1998, 99, *t.* 23: M249).

<sup>8</sup> Večji kos takšnega oklepa je bil po naključju odkrit pri obhodu najdišča poleti 2010, za zdaj je shranjen v Narodnem muzeju Slovenije.

The time from the end of the 5<sup>th</sup> to the beginning of the 7<sup>th</sup> century (phase LA 2) is represented by iron buckles without a plate (*Pl.* 7: 11–16, 18–27), which are typical for autochthonous Romanized sites. We frequently encounter the smaller buckles (*Pl.* 8: 2–5) at Merovingian cemeteries. The plate frame of a small Early Byzantine Mediterranean buckle (*Pl.* 8: 1) which can be assigned to the end of the 5<sup>th</sup> or the beginning of the 6<sup>th</sup> century belongs among the Early Byzantine objects. The L-shaped purse fitting (*Pl.* 8: 18) also belongs to the same time or even later.

The small rhombic buckle (*Pl.* 8: 7; *Fig.* 2.5) belonging to the 6<sup>th</sup> century or even its second half also represents a purse buckle. The second half of the 6<sup>th</sup> century is represented also by the small silver Mediterranean buckle (*Pl.* 8: 8). The strap end made of silver sheet (*Pl.* 8: 20) could represent the Byzantine or even Avar presence at the end of the 6<sup>th</sup> and the beginning of the 7<sup>th</sup> century.

Two Early Medieval pieces belong to the time after the abandonment of the Late Antique settlement. The fitting (*Pl.* 8: 23) was found in a layer of phase LA 2 (SU 11), dated to the end of the 5<sup>th</sup> and the 6<sup>th</sup> century, but it probably slid from the higher above situated Early Medieval layer (SU 10) which is primarily due to the segmented bead (*Pl.* 4: 10) dated to the time around 800. Typologically the fitting is earlier but in Slovenia it is characteristic for the objects of the Avar period to appear in later contexts, supposedly as traces of those who returned with the loot from the Frankish-Avar wars at the end of the 8<sup>th</sup> century (Pleterski 1999, 370). The Carolingian strap end (*Pl.* 8: 22) is a chance find and its connection to the Early Medieval settlement in the building is questionable (see Tonovcov grad. Settlement remains and interpretation, chapter 2.2.4).

## 2.1.4 WEAPONRY

### WEAPONS AND HORSE EQUIPMENT 1<sup>ST</sup>–3<sup>RD</sup> CENTURY

A bronze link with an iron rivet (*Pl.* 9: 1) – a part of a Roman period chain mail of type *lorica hamata* (Van der Sanden 1993, *Fig.* 9) was found in a layer of phase LA 2.<sup>8</sup>

A round ornamented bronze fitting (*Pl.* 9: 2) decorated the straps of horse equipment (cf. Deimel 1987, 97, *Pl.* 84: 13).

It is impossible to assign the precise shape of the poorly preserved iron spur (*Pl.* 9: 3), the best resemblance is recognised to the half-finished spur from Magdalensberg in Carinthia (Dolenz 1998, 99, *Pl.* 23: M249).

<sup>8</sup> A bigger piece of such chain mail was found by chance during the rounds of the site in the summer of 2010 and is for the time being kept at the Narodni muzej Slovenije.

## POZNORIMSKO OBDOBJE

V premešani plasti je ležala svinčena obloga rimske plumbate (*t.* 9: 4). Plumbate je v 4. in na začetku 5. st. uporabljala redna vojska, posebno pogoste pa so bile prav na območju severne Italije, Slovenije in severne Hrvaške (Buora 1997, 240–242).

Železna ost kopja (*t.* 9: 5, detektorska najdba) s tordiranim vratom in verjetno odlomljeno zalustjo ima primerjavo na Brinjevi gori nad Zrečami (Ciglenečki 1994a, t. 2: 14). Podobne, vendar brez tordiranja, so našli na Ančnikovem gradišču pri Jurišni vasi, v Emoni in na Invillinu (Strmčnik 1997, t. 3: 8; Sivec 1997, t. 1: 2–3; Bierbrauer 1987, t. 171: 3). Tovrstna kopja je uporabljala rimska vojska v 4. in 5. stoletju (Feugère 1996, 273).

## POZNA ANTIKA

Od obrambnega orožja so bile v premešanih plasteh najdene štiri polovice lamel lamelnarnega oklepa (*t.* 11: 3–6), kakršnega so uporabljali v 6. stoletju poleg vzhodnjaških ljudstev tudi v drugih delih Evrope (Lebedinsky 2001, 187; Bugarski 2005). Takšne lamele so bile najdene tudi na nekaterih drugih slovenskih višinskih naselbinah, na Zidanem gabru nad Mihovim (Bitenc 2001, kat. 236), na Rifniku (Pirkmajer 2001, kat. 238) in na Gradišču nad Bašljem (Bitenc 2001, kat. 226). Dva v celoti ohranjena lamelarna oklepa sta bila pred nedavnim odkrita v Kranju v stolpu ob obzidju iz druge polovice 6. st. (Odar 2006, 263).

Majhen bronast okov (*t.* 11: 8) je bil najden v plasti faze PA 2. Spominja na okove ščita, zelo podobna okova sta bila najdena na primer v Gültlingenu, datirana sta v zgodnjemerovinško obdobje (Quast 1993, 51–54).

Na območju sosednje stavbe (objekt št. 26; *sl.* 1.1) je bil najden tudi dolg dvorezen meč – spatha (*t.* 11: 10, detektorska najdba). Njegova konica ni ohranjena, sedanja dolžina meča je 60 cm, širina pa 4,8 cm. Ohranjen je rnat ročaj, ki je na koncu upognjen. Obloga ročaja in nožnica niso ohranjeni, zato je najdbo težko časovno umestiti. Širše ga lahko postavimo v čas med konec 5. st. in 7. st. (prim. Knific 2001, kat. 249, 267, 268). Razen spathe je bil najden tudi ščitnik meča (*t.* 11: 9, detektorska najdba). Za zdaj nam ni uspelo najti mu ustreznih primerjav.

**Puščične osti**

Štirinajst osti je s trokrilno konico (*t.* 9: 6–19). Ležale so v plasteh faze PA 2 (*t.* 9: 9, 13, 15, 18) in premešanih plasteh (*t.* 9: 6–8, 10–12, 14, 16–17, 19). Krilca so v nekaterih primerih vitke ovalne oblike (*t.* 9: 7–8, 13, 18), druga pa so bolj rombično oblikovana. Pri nekaterih osteh je prehod med vratom in krilci poudarjen (*t.* 9: 16–17, 19).

## LATE ROMAN PERIOD

In a mixed layer a lead weight of a Roman plumbata (*Pl.* 9: 4) was found. Plumbatae were in the 4<sup>th</sup> and at the beginning of the 5<sup>th</sup> century used by regular army and are especially frequent in the area of northern Italy, Slovenia, and northern Croatia (Buora 1997, 240–242).

The iron spearhead (*Pl.* 9: 5, metal detector find) with a twisted neck and probably broken-off barb has a comparison at Brinjeva gora above Zreče (Ciglenečki 1994a, *Pl.* 2: 14). Similar but not twisted spearheads were also found at Ančnikovo gradišče near Jurišna vas, in Emona, and at Invillino (Strmčnik 1997, *Pl.* 3: 8; Sivec 1997, *Pl.* 1: 2–3; Bierbrauer 1987, *Pl.* 171: 3). Such spears were used by the army during the 4<sup>th</sup> and 5<sup>th</sup> century (Feugère 1996, 273).

## LATE ANTIQUITY

Belonging to the defensive weapons, four halves of lamellar armour plates (*Pl.* 11: 3–6), such as were besides the eastern peoples used also in other parts of Europe during the 6<sup>th</sup> century (Lebedinsky 2001, 187; Bugarski 2005), were found in mixed layers. Such lamellae were found also at some other Slovenian hill-top settlements, at Zidani gaber above Mihovo (Bitenc 2001, cat. no. 236), at Rifnik (Pirkmajer 2001, cat. no. 238), and at Gradišče above Bašelj (Bitenc 2001, cat. no. 226). Two completely preserved lamellar armours were recently found in Kranj, in the tower along the defensive wall from the second half of the 6<sup>th</sup> century (Odar 2006, 263).

A small bronze fitting (*Pl.* 11: 8) was found in a layer of phase LA 2. It resembles the fittings of a shield, two very similar objects were found, for example, in Gültlingen and are dated to the Early Merovingian period (Quast 1993, 51–54).

In the area of the neighbouring building (building no. 26; *Fig.* 1.1) a long double-edged sword – a spatha (*Pl.* 11: 10, metal detector find) was found. The point of the sword is not preserved, the present length is 60 cm, width 4.8 cm. The tanged grip which is bent at the end is preserved. Parts of the handle and sheath are not preserved hence the find is difficult to date. Broadly it can be assigned to the time between the end of the 5<sup>th</sup> and the 7<sup>th</sup> century (cf. Knific 2001, cat. nos. 249, 267, 268). A sword-grip ferrule (*Pl.* 11: 9, metal detector find) was also discovered. Appropriate analogies have yet not been found.

**Arrowheads**

Fourteen arrowheads have trilobate heads (*Pl.* 9: 6–19). They lay in the layers of phase LA 2 (*Pl.* 9:



Poznoantične trokrilne osti so avtorji pogosto pripisovali Hunom in Avarom ali vsaj njihovemu vplivu, U. von Freeden pa je poskusila ločiti avarske osti od sredozemsko-bizantinskih v poznorimski tradiciji (Freeden 1991). Ugotovila je, da lahko večino trokrilnih osti zunaj avarskega območja umestimo v vzhodnorimski krog, avarske osti naj bi se pojavljale omejeno in šele v 7. oziroma v drugi tretjini 7. st.

Med sredozemsko-bizantinske lahko uvrstimo tudi tonovške trokrilne puščične osti. V. Bierbrauer meni, da so trokrilne osti najpogostejše puščične osti v langobardskih grobovih v Italiji in zato predvsem langobardskodobne (Bierbrauer 1987, 170–171). Pogoste so tudi v poznoantičnih naselbinah v Sloveniji (Ciglenečki 1994a, t. 9: 18–19; 10a: 17–18; 11: 16–17). Dodaten argument za tako časovno opredelitev je tudi odsotnost tega tipa osti na naselbini iz konca 4. in začetka 5. st. na Kuzelinu (Sokol 1998).

Dvanajst osti ima ploščato konico (t. 9: 20–23; t. 10: 8–15). Ležale so v plasteh faze PA 2 (t. 9: 21–22; 10: 10–11,14), zgodnesrednjeveški plasti (t. 10: 13) in premešanih plasteh (t. 9: 20,23; 10: 8–9,12,15). Te osti so časovno težko opredeljive, ker so si med seboj zelo različne in se pojavljajo v zelo dolgem časovnem obdobju, od antike do srednjega veka. Do sedaj nam ni uspelo ugotoviti, ali so imele razlike med širokolistno, ozkolistno, trikotno in rombično obliko konice funkcionalen ali kronološki pomen. Med dvanajstimi konicami z območja stavbe 1 jih je šest s trikotno ploščato konico, dve s tulcem (t. 9: 23; t. 10: 13), tri s trnom (t. 9: 20–21; t. 10: 11), ena pa ima spodnji del odlomljen (t. 9: 22). Tri osti imajo širokolistno ploščato konico (t. 10: 10,14,15), dve pa rombično ploščato konico (t. 10: 8–9), kakršne so pogoste v kontekstih iz staromadžarskega obdobja (prim. Nepper 1996, sl. 8). Na Tonovcovem gradu so bile najdene štiri takšne osti, dve na območju stavbe 1 v premešani plasti (t. 10: 8–9) in dve v zgornjih ruševinskih plasteh severne in južne cerkve (t. 47: 4; 49: 10; glej pogl. 2.3), vendar je vprašljivo, ali so res tako pozne. Širokolistne osti z rombično ploščato konico in trnom se na poznoantičnih najdiščih v Sloveniji sicer pojavljajo (na Lajhu v Kranju: Stare 1980: t. 52: 4; 125: 3,5; Zidani gaber nad Mihovim: Ciglenečki 1994a, t. 12: 12), vendar so redke ter daljše in ožje, ne pa v obliki pravih romba kot je značilno za staromadžarske osti.

Sedem puščičnih osti ima konico kvadratnega preseka (t. 10: 1–7), dve s tulcem (t. 10: 1–2), pet s trnom (t. 10: 3–7). Puščica (t. 10: 7) je bila najdena v plasti faze PA 1, ostale so ležale v plasteh faze PA 2 (t. 10: 1–4,6) in premešani plasti (t. 10: 5). Za osti s kvadratnim presekom naj bi veljala podobna datacija kot za osti s trokrilno konico. Von Freednova jih glede na pogosto pojavljanje skupaj postavlja prav tako v sredozemsko-vzhodnorimski krog 6. in 7. st. (Freeden 1991, 605–609). Spadajo med masivnejše osti, ki naj bi bile primerne za prebijanje oklepov in so se lahko prožile z loka (manjše osti), samostrela ali katapulta (večje osti; Bierbrauer 1987, 171). V jugovzhod-

9,13,15,18) and mixed layers (Pl. 9: 6-8,10-12,14,16-17,19). Lobes are sometimes of a narrow oval shape (Pl. 9: 7-8,13,18), others are more rhombic. In some arrowheads the transition between the neck and the lobesis pronounced (Pl. 9: 16-17,19).

Various authors have attributed Late Antique trilobate arrowheads to the Huns and Avars or at least to their influence, while U. von Freeden tried to separate the Avar arrowheads from the Mediterranean-Byzantine ones in the Late Roman tradition (Freeden 1991). She discovered that most of the trilobate arrowheads outside the Avar territory can be seen as eastern Roman, the Avar arrowheads supposedly occurred in a limited area and not before the 7<sup>th</sup> or the second third of the 7<sup>th</sup> century.

Trilobate arrowheads from Tonovcov grad also belong among the Mediterranean-Byzantine arrowheads. V. Bierbrauer believes that trilobate arrowheads are the most frequent arrowheads in the Lombard graves in Italy and thus primarily belong to the Lombard period (Bierbrauer 1987, 170-171). They often appear also in the Late Antique settlements in Slovenia (Ciglenečki 1994a, Pls. 9: 18-19; 10a: 17-18; 11: 16-17). An additional argument for such dating is also the absence of this type of arrowheads at settlements of the end of the 4<sup>th</sup> and the beginning of the 5<sup>th</sup> century at Kuzelin (Sokol 1998).

Twelve arrowheads have a flat head (Pls. 9: 20-23; 10: 8-15). They lay in layers of phase LA 2 (Pls. 9: 21-22; 10: 10-11,14), the Early Medieval layer (Pl. 10: 13), and mixed layers (Pls. 9: 20,23; 10: 8-9,12,15). These arrowheads are difficult to date because they are very different from one another and appear throughout a very long time period, from the Antiquity to the Middle Ages. So far we have been unable to define whether the differences between the wide-leafed, narrow-leafed, triangular, and rhombic shape of the head had a functional or chronological meaning. Out of twelve arrowheads from the area of building 1 six have a triangular flat head, two of them are socketed arrowheads (Pls. 9: 23; 10: 13), three are tanged (Pls. 9: 20-21; 10: 11), and the bottom part of one is broken-off (Pl. 9: 22). Three arrowheads have a wide-leafed flathead (Pl. 10: 10,14-15). Two arrowheads have a rhombic flat head (Pl. 10: 8-9), such as often appear in contexts from the Magyar period (cf. Nepper 1996, Fig. 8). At Tonovcov grad four such arrowheads were found, two in the area of building 1 in a mixed layer (Pl. 10: 8-9) and two in the upper destruction layers of the north and south church (Pls. 47: 4; 49:10; see chapter 2.3). Nevertheless, it remains questionable whether they really are so late. Wide-leafed arrowheads with a rhombic flat head and a tang do appear on Slovenian Late Antique sites (Lajh in Kranj: Stare 1980: Pls. 52: 4; 125: 3,5; Zidani gaber above Mihovo: Ciglenečki 1994a, Pl. 12: 12), but they are rare and longer and narrower in shape, not similar to rhombic heads typical of the Magyar period.

Seven arrowheads have a square-section head (Pl. 10: 1-7), two are socketed (Pl. 10: 1-2), and five

noalpskem prostoru so datirane drugače. V Sloveniji so bile osti s kvadratnim presekom s trnom najdene na Tinju nad Loko pri Žusmu (Ciglencečki 2000, t. 1: 21–26), Ančnikovem gradišču (Strmčnik 1997, t. 3: 9; 5: 8,14), Brinjevi gori (Pahič 1981, t. 4: 6), Rifniku (Bolta 1981, t. 25: 99), v zakladni najdbi s Puštala nad Trnjem (Štukl 2004, t. 2: 6–7), na Korinjskem hribu ter na Hrvaškem na Kuzelinu (Sokol 1994, t. 2: 1–6; Sokol 1998, 23–25). S. Ciglencečki glede na ta najdišča in še nekaj drugih, ki jih omenja (Rodik, Ludbreg, Varaždinske toplice, Ljubljana: Ciglencečki 2000, 55–56), sklepa, da so tovrstne puščične konice značilne prav za konec 4. in prvo polovico 5. st. To datacijo potrjujejo tudi najdbe s Frauenberga nad Lipnico (Steinklauber 2002, grob 229, t. 63: 7–24; 64: 25–43).

Dve osti imata ploščato konico in le vrh rombičnega preseka ter poudarjen prehod v trn (*t. 10: 16–17*), ležali sta v plasti faze PA 2 (*t. 10: 16*) in premešani plasti (*t. 10: 17*). Ta redek tip puščičnih osti je edini, ki naj bi se ga dalo natančneje datirati. U. von Freeden ga datira sočasno s trokrilnimi ostmi s piramidastim vrhom, kakršne na Tonovcovem gradu niso bile najdene, v konec ali zadnjo tretjino 6. st. (Freeden 1991, 602–604).

Ost (*t. 11: 1*) izstopa po obliki, trikoten ploščat list se namreč proti vrhu osti odebeli. Primerljive puščične osti so bile najdene na Sadovcu v kontekstih justinijanskega kastela, ki je bil zgrajen v štiridesetih letih 6. st. Predvidoma lahko torej postavimo osti v 6. stol. ali celo njegovo drugo polovico (Uenze 1992, 94–97, t. 40: 51–52).

Ost (*t. 11: 2*) ima dvokrilno konico in tulec, ležala je v zgodnj srednjeveški plasti v stavbi 1.

Od puščične osti (*t. 9: 24*) se je v plasti faze PA 2 ohranil le tulec.

Puščične osti so seveda uporabljali tudi za lov, vendar izsledki študij srednjeveškega gradiva kažejo, da so se v ta namen uporabljale drugačne oblike osti kot za boj (Jessop 1996). Poleg tega je analiza živalskih kostnih ostankov pokazala, da je bila na Tonovcovem gradu najdena le zanemarljiva količina ostankov lovnih živali, večinoma jelena (glej pogl. 8). Tako lahko sklepamo, da so najdene puščične osti dejansko služile v vojaške namene. Glede na razprostranjenost osti v prostoru ne moremo podati posebnih ugotovitev, ležale so pred stavbo 1 in vzhodno od nje, kjer je bila sicer zgoščena večina drobnega gradiva iz faze PA 2 (prim. Tonovcov grad. Naselbinski ostanki in interpretacija, pogl. 3.1, sl. 3.15). Da so bile verjetno uporabljene pri napadu na naselbino, lahko sklepamo predvsem zaradi tistih osti, ki imajo poškodovane vrhove konic (npr. *t. 9: 7,11,13,21,23; 10: 11*).

Večja ost rombastege preseka s tulom predstavlja glede na primerjave s Sadovca (Uenze 1992, t. 41: 18) katapultni izstrelek (*t. 11: 7*). Primerljivi bolgarski izstrelek je bil najden v kontekstu sredine ali druge polovice 6. st. (Uenze 1992, 97), tonovski primerek pa je ležal v

are tanged (*Pl. 10: 3–7*). An arrowhead (*Pl. 10: 7*) was found in a layer of phase LA 1, others lay in layers of phase LA 2 (*Pl. 10: 1–4,6*) and a mixed layer (*Pl. 10: 5*). Arrowheads with a square cross section are considered similar to the arrowheads with a trilobate head. Freeden assigns them, since they frequently appear together, to the Mediterranean-east Roman circle of the 6<sup>th</sup> and 7<sup>th</sup> century (Freeden 1991, 605–609). They belong among the more massive arrowheads which were supposedly appropriate for piercing armours and could be shot from a bow (smaller arrowheads), a crossbow, or a catapult (bigger arrowheads; Bierbrauer 1987, 171). In the south-eastern Alps these are dated differently. In Slovenia tanged arrowheads with a square cross section of the head were found at Tinje above Loka pri Žusmu (Ciglencečki 2000, Pl. 1: 21–26), Ančnikovo gradišče (Strmčnik 1997, Pls. 3: 9; 5: 8,14), Brinjeva gora (Pahič 1981, Pl. 4: 6), Rifnik (Bolta 1981, Pl. 25: 99), in a hoard from Puštal, and Trnje (Štukl 2004, Pl. 2: 6–7) on Korinjski hrib, and in Croatia at Kuzelin (Sokol 1994, Pl. 2: 1–6; Sokol 1998, 23–25). S. Ciglencečki, according to these and some other sites that he mentions (Rodik, Ludbreg, Varaždinske Toplice, Ljubljana: Ciglencečki 2000, 55–56), concludes that such arrowheads are characteristic of the end of the 4<sup>th</sup> and the first half of the 5<sup>th</sup> century. This dating is supported also by the finds from Frauenberg above Leibnitz (Steinklauber 2002, grave 229, Pls. 63: 7–24; 64: 25–43).

Two arrowheads have a flat head with a tip of rhombic cross section and a pronounced transition to the tang (*Pl. 10: 16–17*). They were found in a layer of phase LA 2 (*Pl. 10: 16*) and a mixed layer (*Pl. 10: 17*). This rare type of arrowheads is the only one that we are supposed to be able to date more precisely. U. von Freeden dates it contemporary to trilobate arrowheads with a pyramidal tip, which do not appear at Tonovcov grad, to the end or the last third of the 6<sup>th</sup> century (Freeden 1991, 602–604).

An arrowhead (*Pl. 11: 1*) stands out regarding its shape, namely, the triangular flat head thickens towards the tip. Comparable arrowheads were found at Sadovec in the context of Justinian's fort built in the 540s. Thus these arrowheads can be assigned to the 6<sup>th</sup> century or even its second half (Uenze 1992, 94–97, Pl. 40: 51–52).

An arrowhead (*Pl. 11: 2*) has a bilobate head (swallow tail) and a socket, it was found in the Early Medieval layer in building 1.

Only a socket remains from an arrowhead (*Pl. 9: 24*) in a layer of phase LA 2.

Arrowheads were naturally also used for hunting but the results of the studies of medieval material show that a different form of arrowheads was used for this purpose than for battle (Jessop 1996). The analysis of animal remains revealed that a negligible number of wild animal remains, mostly deer (see chapter 8), were found at Tonovcov grad. Thus we can conclude that the discovered arrowheads were indeed used for military purposes. The



Sl. 2.7: Najdba delov rala v stavbi 1 (t. 14: 1-2; foto: S. Ciglenečki.)

Fig. 2.7: Parts of a plough found in building 1 (Pl. 14: 1-2; photo: S. Ciglenečki.)

premešani plasti. Sama oblika izstrelka je dolgotrajna, predmet je glede na lego lahko tudi starejši ali mlajši.

### 2.1.5 ORODJE

1.-3. ST.

Bronast ščitnik za ročaj noža (t. 12: 1), ki je ležal v premešani plasti, spada med zgodnje antične najdbe druge polovice 1. in 2. st. (Istenič 1999, 69, sl. 55).

### POZNA ANTIKA

#### Poljedeljsko orodje

V premešani plasti sta bila najdena dva dela kose (t. 12: 2-3).

Kosirji (t. 12: 4-11) so ležali v plasti faze PA 1 (t. 12: 7), plasti notranje hodne površine stavbe (t. 12: 6), plasteh faze PA 2 (t. 12: 4,10) in v premešanih plasteh (t. 12: 5,8-9,11).

Srp (t. 13: 7, detektorska najdba) ni v celoti ohranjen. Ima rahlo upognjeno rezilo in spada v skupino H1 po J. Henningu. Srpi te skupine časovno niso izpovedni, saj se pojavljajo že od 1. st. dalje (Henning 1987, 43, 86-91).

Dela rala, lemež in črtalo (t. 14: 1-2), sta bila najdena v plasti padlega ometa v vogalu zidov 2 in 3 v stavbi 1 (sl. 2.7). K ralu morda spada tudi veriga (t. 14: 3).

Od šestih usločenih okovov z luknjicami (t. 12: 12-13; t. 13: 1-4), katerih funkcija še ni pojasnjena, so trije ležali v plasti zunanje hodne površine stavbe 1 (t. 13: 3) in v plasti faze PA 2 (t. 12: 12; 13: 4), za ostale

spatial distribution of arrowheads did not present any special conclusions, they lay in front of building 1 and to the east of it, where concentrations of all small finds in phase LA 2 are observed (cf. Tonovcov grad. Settlement remains and interpretation, chapter 3.1, Fig. 3.15). That they were used in the attack on the settlement can be noticed especially in those arrowheads, the tips of which are damaged (e.g. Pls. 9: 7,11,13,21,23; 10: 11).

A bigger socketed head of a rhombic cross section, considering the parallels from Sadovec (Uenze 1992, Pl. 41: 18), represents a catapult projectile (Pl. 11: 7). The Bulgarian analogy was found in the context of the middle or the second half of the 6<sup>th</sup> century (Uenze 1992, 97), the example from Tonovcov grad was lying in a mixed layer. This form of the projectile appears through a long period of time, the object can also be, considering its position, earlier or later.

### 2.1.5 TOOLS

1<sup>ST</sup>-3<sup>RD</sup> CENTURY

A bronze knife grip-guard (Pl. 12: 1) which was lying in a mixed layer (Istenič 1999, 69, Fig. 55) belongs among the Early Antique finds from the second half of the 1<sup>st</sup> and the 2<sup>nd</sup> century.

### LATE ANTIQUITY

#### Agricultural tools

In a mixed layer two parts of a scythe (Pl. 12: 2-3) were found.

Collar ferrules (Pl. 12: 4-11) were lying in a layer of phase LA 1 (Pl. 12: 7), in the inner walking surface of the building (Pl. 12: 6), layers of phase LA 2 (Pl. 12: 4,10), and in mixed layers (Pl. 12: 5,8-9,11).

A sickle (Pl. 13: 7, metal detector find) is not completely preserved. It has a slightly curved blade and belongs to group H1 according to J. Henning. Sickles of this group are not precisely dated since they appear from the 1<sup>st</sup> century onwards (Henning 1987, 43, 86-91).

Parts of a plough, a share and a coulter (Pl. 14: 1-2) were found in the layer of fallen-off plaster along the corner of walls no. 2 and 3 within building 1 (Fig. 2.7). A chain (Pl. 14: 3) could belong to a plough.

Three out of six bent fittings with small holes (Pls. 12: 12-13; 13: 1-4), the function of which is yet to be determined, lay in the outer walking surface of building 1 (Pl. 13: 3) and in the layer of phase LA 2 (Pls. 12: 12; 13: 4). The context of other three is unknown. The opinion of S. Ciglenečki that the fittings are component parts of a plough is based on the fact that three were found in

pa kontekst ni znan. Mnenje S. Ciglenceškega, da so ti okovi sestavni deli rala, temelji na dejstvu, da so bili trije najdeni v zakladni najdbi na Tinju nad Loko pri Žusmu skupaj z lemežem in gredeljnico (Božič, Ciglenceški 1995, 262). Najdbe na drugih najdiščih ne potrjujejo te teze. Na Korinjskem hribu so bili najdeni štiri (Ciglenceški 1985, t. 2: 35–36, dva sta neobjavljena), v vsakem stolpu po eden, v naselbini pa ni bilo najdenega veliko drugega orodja. Situacija na Korinjskem hribu tako nakazuje za te okove bolj funkcijo v zvezi z deli zgradb oz. nečim, kar je bilo prisotno v vsakem stolpu. Poseben je tudi način njihove pritrditve. Luknje v okovih namreč kažejo na to, da so bili žebli pritrjeni skozi tako, da usločen del okova ni legel na podlago, temveč je štrlel stran od nje, na kar sta opozorila že S. Ciglenceški in D. Božič (Božič, Ciglenceški 1995, 262).

### Obdelava lesa

Najdeni sta bili dve polkrožni rezili (t. 13: 5–6; detektorski najdbi). Za tovrstna rezila je veljalo, da so se uporabljala za rezanje usnja, vendar novejša raziskava kažejo, da so imela vsaj nekatera drugačen namen. Polkrožna, ki imajo zobce ukrivljene navzkriž (kot t. 13: 6), naj bi bila sodarsko orodje za vrezovanje utorov (Sagadin 2000, 206). Večino tovrstnih rezil z ravnimi zobci (kot t. 13: 5) pa lahko še naprej razumemo kot rezila za usnje. V Sloveniji so bila taka orodja najdena še v zakladu z Grdavevega hriba (zobci navzkriž; Sagadin 2000, t. 2: 7), v objektu 6 na Tinju nad Loko pri Žusmu (ravni zobci; Ciglenceški 2000, t. 5: 9) ter na Korinjskem hribu (ravni zobci; Ciglenceški 1985, t. 3: 38).

Ukrivljeno rezilo za dolbenje lesa (t. 28: 14; detektorska najdba) ima prav tako neposredne primerjave z modernim nožem za dolbenje lesenih posod (Sagadin 2000, sl. 2).

Tudi poškodovan železen predmet spominja na orodje za dolbenje lesa (t. 21: 15, detektorska najdba).

Dve podaljšani čeli sekir (t. 14: 4–5) sta ležali v premešani plasti. Trije odlomki rezil (t. 14: 6–8), ki so bili najdeni v plasteh faze PA 2 (t. 14: 6–7) in premešani plasti, so verjetno deli sekir.

V plasteh faze PA 2 (t. 15: 2,7), zgodnjesevrednejši (t. 15: 4) in premešani plasti (t. 15: 1, 3,5–6,8) so bili najdeni štiri spiralni (t. 15: 1–4) in štiri žličasti svedri (t. 15: 5–8) (Gaitzsch 1980, 33–34).

### Ribolov

Trnki (t. 16: 1–9) so ležali v plasteh faze PA 1 (t. 16: 6), faze PA 2 (t. 16: 3–4,7), v ruševini (t. 16: 1), zgodnjesevrednejši (t. 16: 5) in premešani plasti (t. 16: 2,8–9).

Svinčeni svitki (t. 17: 6–12) lahko predstavljajo uteži za ribiške mreže (Feugère 1992, 147–149; Bergen

the hoard at Tinje above Loka pri Žusmu, together with a plough share and chain (Božič, Ciglenceški 1995, 262). Finds from other sites do not confirm this thesis. At Korinjski hrib four such fittings were found (Ciglenceški 1985, Pl. 2: 35–36, two are unpublished). They were found one in each tower while not many other tools were found at the settlement. The situation at Korinjski hrib thus indicates that the function of these fittings was primarily connected to the parts of buildings or something present in every tower. The manner in which they were attached is also special. Namely, the holes in the fittings indicate that the nails were through them attached thus that the bent part of the fitting did not fit the base but projected away from it, as was stated already by S. Ciglenceški and D. Božič (Božič, Ciglenceški 1995, 262).

### Wood processing

Two semicircular blades (*Pl. 13: 5–6*; metal detector finds) were found. Such blades were once believed to be used for the cutting of leather but recent research shows that at least some of them had a different purpose. Those semicircular blades which have teeth bent crosswise (as *Pl. 13: 6*) are supposed to represent coopering tools for incising mortises (Sagadin 2000, 206). Still, most of such blades with straight teeth (as *Pl. 13: 5*) can continue to be interpreted as blades for leather cutting. In Slovenia such tools were also found in the hoard from Grdaveve hrib (crosswise teeth; Sagadin 2000, Pl. 2: 7), in building 6 at Tinje above Loka pri Žusmu (straight teeth; Ciglenceški 2000, Pl. 5: 9), and at Korinjski hrib (straight teeth; Ciglenceški 1985, Pl. 3: 38).

A bent blade for chiselling-outwood (*Pl. 28: 14*; metal detector find) also has direct analogies with modern knives for chiselling-outwooden vessel (Sagadin 2000, Fig. 2).

A damaged iron object also resembles tools for wood chiselling (*Pl. 21: 15*, metal detector find).

Two extended axe polls (*Pl. 14: 4–5*) were lying in a mixed layer. Three blade fragments (*Pl. 14: 6–8*), which were found in layers of phase LA 2 (*Pl. 14: 6–7*) and a mixed layer, are probably parts of axes.

In layers of phase LA 2 (*Pl. 15: 2,7*), the Early Medieval (*Pl. 15: 4*) and mixed layer (*Pl. 15: 1,3,5–6,8*) four drill (*Pl. 15: 1–4*) and four spoon bits of augers (*Pl. 15: 5–8*) (Gaitzsch 1980, 33–34) were found.

### Fishing

Fish hooks (*Pl. 16: 1–9*) were found in layers of phase LA 1 (*Pl. 16: 6*), phase LA 2 (*Pl. 16: 3–4,7*), the destruction layer (*Pl. 16: 1*), the Early Medieval layer (*Pl. 16: 5*), and a mixed layer (*Pl. 16: 2,8–9*).

2005, 84). Ležali so v plasteh faze PA 1 (*t. 17: 10*), PA 2 (*t. 17: 8–9*), v zgodnj srednjeveški (*t. 17: 11–12*) in premešani plasti. Glede na to, da so takšni predmeti najdeni tudi na najdiščih, ki niso blizu vode, so bili lahko tudi v kakšni drugačni rabi. Vsaj omenimo lahko običaj zapisovanja zakletev in prošenj na svinčene ploščice, ki so jih zvite odmetavali ali zakopavali ter se tako priprošali božanstvom ali zaklinjali sovražnike (prim. npr. Blänsdorf 2005).

## Razno

Šivanke (*t. 17: 13–32*) so se lahko uporabljale tako za šivanje mrež kot za šivanje blaga.

Šivanka (*t. 17: 26*) je bila najdena v plasti faze PA 1, ostale v plasteh faze PA 2 (*t. 17: 21,25,27–32*) in premešanih plasteh.

Pri preji so se uporabljala svinčena (*t. 16: 9–15*) in keramična (*t. 16: 18–25; 17: 1–5*) vretenca (Bergen 2005, 79–84; Krasnik 2009, 95). Vretence (*t. 16: 10*) je bilo najdeno v plasti odpadlega ometa v stavbi 1, vretence (*t. 16: 15*) v plasti faze PA 2, ostala svinčena (*t. 16: 9,11–14*) pa so ležala v premešani plasti.

Konice železnega glavnika (*t. 15: 9*) so ležale v stavbi 1 v zgodnj srednjeveški plasti, del mikalnika (*t. 16: 17*) pa v plasti faze PA 1. Mikalnik je narejen iz lesene plošče z eno vrsto železnih zobcev, glavnik pa je lahko lesen ali kovinski, z eno ali dvema vrstama zobcev (Krasnik 2009, 70, 94). Večinoma dvovrstne železne glavnike so uporabljali pri izdelavi tkanin za izčesavanje nečistoč iz volne in lanu. P. Bitenc je objavila primerke, ki se pojavljajo od 1. st. do pozne antike (Bitenc 2002), B. Krasnik pa oblikovno enake primerke omenja tudi iz slovanskega obdobja (Krasnik 2009, 70). Med mikalnikom in glavnikom ni velike razlike v uporabi, oba sta namenjena odstranjevanju nečistoč iz rastlinskih vlaken in volne.

Šilasta železna predmeta (*t. 19: 1–2*), ki sta ležala v plasti faze PA 2 (*t. 19: 1*) in v premešani plasti (*t. 19: 2*), po merah in obliki spominjata na podobne najdbe v poznorimskih grobovih na Madžarskem, predvsem v okolici Keszthelyja, ki so interpretirani kot preslice (Müller 2010, 231, t. 94: 9). Še en tak predmet je bil najden na Tonovcovem gradu v stavbi 3 (*t. 46: 8*), drugje v Sloveniji pa v hiši E na Ajdovskem gradu nad Vranjem (Knific 2001, kat. 146) in v hiši 7 na Rifniku (Bolta 1981, t. 25: 97).

Šest stilusov (*t. 18: 5–10*) je ležalo v plasteh faze PA 2 (*t. 18: 9–10*) in v premešani plasti.

Lopatka za glajenje voščenih tablic (*t. 19: 3*) iz plasti faze PA 2 spada v tip B2 po M. Feugère, datiran v rimsko obdobje (Feugère 1995, 322–325; Merten 1987, 311–312).

Še en železen predmet bi lahko predstavljal lopatko za vosek (*t. 19: 14*), ležal pa je v zgodnj srednjeveški plasti v prizidku stavbe 1.

Lead coils (*Pl. 17: 6–12*) could be weights for fishing nets (Feugère 1992, 147–149; Bergen 2005, 84). They lay in layers of phase LA 1 (*Pl. 17: 10*), LA 2 (*Pl. 17: 8–9*), the Early Medieval layer (*Pl. 17: 11–12*), and mixed layer. Considering that such objects are found also on sites located far from water, they could have also had a different use. Let us just mention the habit of writing curses and supplications on lead plates which were then rolled and thrown or buried. These were prayers to gods or curses of enemies (cf. e.g. Blänsdorf 2005).

## Miscellaneous

Needles (*Pl. 17: 13–32*) were used for sewing nets and fabric.

A needle (*Pl. 17: 26*) was found in a layer of phase LA 1, others were found in layers of phase LA 2 (*Pl. 17: 21,25,27–32*) and mixed layers.

In spinning, lead (*Pl. 16: 9–15*) and pottery (*Pls. 16: 18; 17: 1–5*) spindle-whorls (Bergen 2005, 79–84; Krasnik 2009, 95) were used. A spindle-whorl (*Pl. 16: 10*) was found in the layer of the fallen-off plaster within building 1, a spindle-whorl (*Pl. 16: 15*) in a layer of phase LA 2, while other lead ones (*Pl. 16: 9,11–14*) were lying in a mixed layer.

Teeth of an iron comb (*Pl. 15: 9*) were lying within building 1, in the Early Medieval layer, while a part of a carder (*Pl. 16: 17*) was found in a layer of phase LA 1. The carder is made of a wooden board with one row of iron teeth and the comb can be wooden or metal, with one or two rows of teeth (Krasnik 2009, 70, 94). Double-sided iron combs were mostly used in fabric manufacturing to comb out the impurities from wool and flax. P. Bitenc published examples occurring from the 1<sup>st</sup> century till Late Antiquity (Bitenc 2002), while B. Krasnik mentions examples of the same form also from the Slavic period (Krasnik 2009, 70). There is no significant difference in use between the carder and the comb, both are intended for clearing impurities from plant fibres and wool.

Two pointed iron objects (*Pl. 19: 1–2*), which were lying in a layer of phase LA 2 (*Pl. 19: 1*) and a mixed layer (*Pl. 19: 2*), considering the measures and form resemble similar finds from the Late Roman graves in Hungary, mostly around Keszthely, which are interpreted as distaffs (Müller 2010, 231, Pl. 94: 9). Another such object was found at Tonovcov grad, in building 3 (*Pl. 46: 8*), and elsewhere in Slovenia in house E at Ajdovski gradec above Vranje (Knific 2001, cat. no. 146) and in house 7 at Rifnik (Bolta 1981, Pl. 25: 97).

Six styli (*Pl. 18: 5–10*) were discovered in layers of phase LA 2 (*Pl. 18: 9–10*) and in a mixed layer.

A small spatula for smoothing wax plates (*Pl. 19: 3*) from layers of phase LA 2 belongs to type B2 according to M. Feugère, dated to the Roman period (Feugère 1995, 322–325; Merten 1987, 311–312).



Sl. 2.8: Najdba delov koles ob stavbi 1 (t. 18: 1-4; foto: S. Ciglencečki.)

Fig. 2.8: Parts of wheels found outside building 1 (Pl. 18: 1-4; photo: S. Ciglencečki.)

Dve majhni dvostrani lopatki (t. 19: 5-6), ki sta ležali v premešani plasti, sta se lahko uporabljali podobno ali za mešanje, nanašanje ali dodelavo različnih snovi (Dolenz 1998, 225, t. 85: W419).

Železni deli koles (t. 18: 1-4), dva trakasta (t. 18: 1-2) in dva pestna obroča (t. 18: 3-4), so bili najdeni na zunanji strani zidu št. 3 v žganinski plasti (sl. 2.8).

Pri obeh polovicah škarij (t. 19: 7-8) pregib ni ohranjen, zato oblike ne moremo natančneje določiti. Manjše (t. 19: 7) so bile najdene v plasti faze PA 1, večje pa v plasti faze PA 2.

Najdenih je bilo tudi pet šil (t. 19: 9-13). Šilo (t. 19: 9) je ležalo v plasti odpadlega ometa v stavbi 1, šilo (t. 19: 10) v plasti faze PA 2, ostala pa v premešanih plasteh.

Deli železnih okovov z vtolčenimi buncicami so najverjetneje sestavljali lesena vedra (t. 21: 7-14). Ležali so v plasteh faze PA 2 (t. 21: 8-9,12-14) in v premešanih plasteh.

Od ostalih delov veder ali kovinskih posod je bilo najdenih nekaj železnih ataš različnih oblik (t. 20: 3-10; 21: 1-4,6) in dva ročaja okroglega preseka (t. 20: 1-2). Ataša (t. 21: 6) in ročaj (t. 20: 1) sta bila najdena v plasteh faze PA 1, ostali deli pa v plasteh faze PA 2 (t. 20: 2,4-5,8-10), v zgodnjerednjeveški (t. 21: 2) in v premešani plasti.

Another iron object could represent a small wax spatula (Pl. 19: 14). It was found in the Early Medieval layer in the outhouse of building 1.

Two small two-sided spatulae (Pl. 19: 5-6), which were lying in a mixed layer, could have been used similarly or for mixing, applying or finishing of various materials (Dolenz 1998, 225, Pl. 85: W419).

Iron parts of wheels (Pl. 18: 1-4), two tire (Pl. 18: 1-2) and two hub rings (Pl. 18: 3-4) were found at the outer side of the wall no. 3, in a layer of burnt remains (Fig. 2.8).

With both shear halves (Pl. 19: 7-8) the fold is not preserved thus the form cannot be more precisely defined. The smaller one (Pl. 19: 7) was found in a layer of phase LA 1, the bigger one in a layer of phase LA 2.

Five awls (Pl. 19: 9-13) were also found. An awl (Pl. 19: 9) was lying in the layer of fallen-off plaster within building 1, an awl (Pl. 19: 10) in a layer of phase LA 2, the other three were found in mixed layers.

Parts of iron fittings with punched dots were most probably component parts of wooden buckets (Pl. 21: 7-14). They lay in layers of phase LA 2 (Pl. 21: 8-9,12-14) and in mixed layers.

From other parts of buckets or metal vessels a few iron suspension loops of various forms (Pls. 20: 3-10; 21: 1-4,6) and two handles of round cross section (Pl. 20: 1-2) were found. A suspension loop (Pl. 21: 6) and a handle (Pl. 20: 1) were found in layers of phase LA 1, other parts were discovered in layers of phase LA 2 (Pl. 20: 2,4-5,8-10), in the Early Medieval layer (Pl. 21: 2), and in a mixed layer.

An iron hook (Pl. 21: 5) found in a mixed layer could have been used for hanging a cauldron.

A few parts of a steelyard were also found. A fragment of a chain link (Pl. 22: 12) was lying in a layer of phase LA 1. A part of a chain with hooks and one fragment of a chain (Pl. 22: 4,10) were found in the layer which represents the walking surface within building 1. A part of a hook, on which a steelyard was hanging (Pl. 22: 9), and a fragment of a chain link (Pl. 22: 11), which was lying in the outer walking surface around building 1, were also found. Two chain links and two hooks belong to steelyards (Pl. 22: 1,5-6,8), one of these chain links (Pl. 22: 5) was lying in the outer walking surface of the building, while the others were found in a mixed layer. A hook (Pl. 22: 7) was also found in a mixed layer.

The steelyards were also discovered in house A at Ajdovski gradec above Vranje (Knific 1979, cat. nos. 1-3), in the third hoard at Polhograjska gora (Božič 2005, 351-353), and at Zbelovska gora (Gaspari et al. 2000, Fig. 8: 15). D. Božič suggests that the two steelyards from Polhograjska gora and Zbelovska gora be marked type Gora. The steelyard from Tonovcov grad, what is left of it, differs from the two in that it has just one element for hanging twisted hooks, in the shape of

Železen kavelj (*t. 21: 5*), najden v premešani plasti, bi lahko služil za obešanje kotla.

Najdenih je bilo tudi nekaj delov hitre tehtnice. Odlomek člena verige (*t. 22: 12*) je ležal v plasti iz faze PA 1. Del verige s kavlji in en odlomek verige (*t. 22: 4,10*) so ležali v plasti, ki predstavlja hodno površino v stavbi 1. Poleg teh sta bila najdena še delček kavlja, na katerem je bila obešena tehtnica (*t. 22: 9*), in odlomek člena verige (*t. 22: 11*), ki je ležal v plasti zunanje hodne površine okrog stavbe 1. Tudi dva člena verige in dva kavlja spadajo k tehtnici (*t. 22: 1,5–6,8*), od teh je člen verige (*t. 22: 5*) ležal v plasti zunanje hodne površine stavbe, ostali pa v premešani plasti. V premešani plasti je ležal tudi kavelj (*t. 22: 7*).

Tehtnice so bile najdene še v hiši A na Ajdovskem gradu nad Vranjem (Knific 1979, kat. 1–3), v tretji zakladni najdbi na Polhograjski gori (Božič 2005, 351–353) in na Zbelovski gori (Gaspari et al. 2000, sl. 8: 15). Za hitri tehtnici s Polhograjske gore in Zbelovske gore D. Božič predlaga oznako tip Gora. Tonovška tehtnica, kar je je ohranjene, se od teh dveh razlikuje v tem, da ima namesto dveh elementov za obešanje tordiranih kavljev samo enega v obliki črke omega (*t. 22: 4*), tordirani kavlji pa so nekoliko drugače oblikovani. Tehtnica z Zbelovske gore je zaradi podobnosti z bronastimi tehtnicami tipa Konstantinopol datirana v 5. in 6. st. (Gaspari et al. 2000, 200), tista iz tretjega depoja s Polhograjske gore pa v konec 4. in začetek 5. st. D. Božič dvomi o dataciji depoja z Zbelovske gore, saj s tega najdišča nimamo znanih najdb s konca 5. in 6. st. Tonovška tehtnica je bila najdena na hodni površini hiše 1 in je glede na stratigrafsko situacijo datirana v 6. st.

K hitri tehtnici spada tudi svinčena utež (masa = 78,50 g; *t. 22: 13*), ki je ležala v plasti zunanje hodne površine stavbe (SE 24).

V premešani plasti je bila najdena še bronasta kvadratna utež (*t. 22: 2*) z dvema slabo ohranjenima portretoma v reliefu. Spada med kvadratne novčne uteži z enim ali dvema cesarskima portretoma, kakršne so bile v uporabi med 4. st. in drugo polovico 6. st. Tonovška se od večine nekoliko razlikuje, saj sta portreta izdelana v reliefu, ne pa vrezana ali vložena na primer v srebro. Na uteži ni razpoznavne oznake za težo, tehta pa 3,93 g. Po velikosti in teži se najbolj približuje utežem za en solid oz. za eno nomismo, ki naj bi tehtale 4,5 g. Glede na to, da je naš primerek precej slabo ohranjen in da se je teža uteži v pozni antiki večkrat oddaljila od predpisane, jo najverjetneje lahko opredelimo kot novčno utež za en solid (Schilbach 2001, 244–247).

Svinčena utež približno kvadratne oblike (*t. 28: 11*), ki je ležala v premešani plasti, ima na površini iz vtisnjenih pik oblikovan znak, podoben črki Y. Tehta 1,25 g. Za to utež nismo našli veliko primerjav med antičnimi najdbami, podobne, vendar bronaste ali steklene uteži se pojavljale v bizantinskih utrdbah na Donavi (Špehar

the letter omega, instead of two elements (*Pl. 22: 4*) and the twisted hooks are slightly differently shaped. The steelyard from Zbelovska gora is due to its resemblance to bronze steelyards of type Constantinople dated to the 5<sup>th</sup> and 6<sup>th</sup> century (Gaspari et al. 2000, 200). The steelyard from the third hoard at Polhograjska gora is dated to the end of the 4<sup>th</sup> and the beginning of the 5<sup>th</sup> century. D. Božič doubts the dating of the hoard from Zbelovska gora because we do not have any known finds from this site from the end of the 5<sup>th</sup> and the 6<sup>th</sup> century. The steelyard from Tonovcov grad was found on the walking surface of building 1 and is considering the stratigraphic situation assigned to the 6<sup>th</sup> century.

A lead weight (78.50 g; *Pl. 22: 13*), which was lying in the outer walking surface of the building (SU 24), also belonged to a steelyard.

A bronze square weight (*Pl. 22: 2*) with two poorly preserved portraits in relief was also found in a mixed layer. It belongs among square coin weights with one or two imperial portraits as were used between the 4<sup>th</sup> and the second half of the 6<sup>th</sup> century. The one from Tonovcov grad slightly differs from most since the two portraits are made in relief and are not incised or inlaid, for example, in silver. The weight does not reveal a recognisable marking for the weight but it weighs 3.93 g. In size and weight it is the closest to weights for one solidus or ononomisma, which were supposed to weigh 4.5 g. Considering the fact that our example is fairly poorly preserved and that the weight of the weight in Late Antiquity often differed from the regulation, it can most probably be defined as coin weight for one solidus (Schilbach 2001, 244–247).

A lead weight of approximately square shape (*Pl. 28: 11*), which was lying in a mixed layer, has a mark similar to the letter Y made of impressed dots on the surface. It weighs 1.25 g. There were not many comparisons found for this weight among the Antique weights. Similar ones but made of bronze or glass appear only among the finds from Byzantine fortifications on the Danube (Špehar 2010, 80–81, cat. nos. 242–249). Possibly better comparisons can be found among Medieval bronze and lead weights (Egan 1998, 309–320, Fig. 230: 979).

A Late Roman lead seal (*Pl. 22: 3*) was found in a layer of phase LA 1. Two portraits are visible on one side and a winged Victoria on the other.

Five chisels (*Pl. 23: 1–5*) belong among the tools for treatment of stone and wood. Two were found in layers of phase LA 2 (*Pl. 23: 1,5*), other three in a mixed layer. Four (*Pl. 23: 1–2,4–5*) belong among wide chisels with a short blade, which were supposedly used primarily for smoothing stone or wooden surfaces or as a small spatula (Pietsch 1983, 35–36). A chisel (*Pl. 23: 3*) belongs among chisels with a long handle as were supposedly used mostly in stone-cutting (Pietsch 1983, 36).

2010, 80–81, kat. 242–249). Morda lahko najdemo boljše primerjave med srednjeveškimi bronastimi in svinčenimi utežmi (Egan 1998, 309–320, sl. 230: 979).

V plasti faze PA 1 je bil najden poznorimski svinčeni pečat (*t. 22: 3*). Na eni strani sta vidna dva portreta, na drugi pa krilata Viktorija.

Pet dlet (*t. 23: 1–5*) spada med orodje za obdelavo kamna ali lesa. Dve sta bili najdeni v plasteh faze PA 2 (*t. 23: 1,5*), preostala dva v premešani plasti. Štiri dleta (*t. 23: 1–2,4–5*) spadajo med široka dleta s kratkim listom, ki naj bi se uporabljala predvsem za glajenje kamnite ali lesene površine, lahko pa tudi kot lopatica (Pietsch 1983, 35–36). Dleto (*t. 23: 3*) spada med dleta z dolgim ročajem, kakršna naj bi se uporabljala predvsem v kamnoseštvu (Pietsch 1983, 36).

### Noži in nožnice

Na območju stavbe 1 je bilo najdeno tudi veliko različnih nožev (*t. 23: 6–17; 24: 1–16; 25: 1–14; 26: 1–5; 27: 1–2*). Večina jih je ležala v plasteh faze PA 2 (*t. 23: 9–10,13–14,17; 24: 2,7,10–11,13,15; 25: 2,5,10,12*), nekateri pa pa v plasti notranje (*t. 24: 5*) in zunanje (*t. 23: 9,16; 24: 8,14; 25: 4*) hodne površine stavbe 1, v zgornji ruševini (*t. 23: 7–8; 24: 12; 25: 1,3*) ter v zgodnjersrednjeveški plasti stavbe (*t. 26: 2–3*) in prizidka (*t. 26: 4–5*). Ostali (*t. 23: 6,11–12,15; 24: 3–4,6,9,16; 25: 6–9,13–14*) so bili najdeni v premešanih plasteh.

Manjši ukrivljeni noži (*t. 25: 9–14*) so se lahko uporabljali tudi v medicini ali kozmetiki.

Nož s klekasto zalomljenim hrptom (*t. 26: 1*, detektorska najdba) lahko postavimo v 9. st. Odlične primerjave mu lahko najdemo v moškem grobu 43 v Bodeščah, ki je datiran v konec 8.–9. st. (Knific, Pleterski 1981, t. 14: 6), in na Gradišču nad Bašljem, kjer so predmeti datirani večinoma med začetkom 9. in prvo polovico 10. stol. (Bitenc, Knific 2001, kat. 324, 325). Primerljiv nož je bil najden tudi na Tonovcovem gradu bližnjem najdišču Sv. Volar nad Robičem (Knavs, Mlinar 2000–2004, 169).

Najboljše primerjave okovu nožnice (*t. 26: 6*), ki je ležal v zgodnjersrednjeveški plasti v stavbi 1, najdemo na Ajdni nad Potoki, kjer je bilo v stavbi v plasti nad ruševino iz druge polovice 6. st. najdenih nekaj predmetov, datiranih v začetek 9. st. (Vidrih Perko, Sagadin 2004, 221, sl. 10). Dva podobna, vendar okrašena okova sta bila najdena na Gradišču nad Bašljem, kjer sta datirana v začetek 9. do 1. polovice 10. st. (Bitenc, Knific 2001, kat. 324). Okov je bila najden tudi na Gradišču nad Dešnom (Pavlin, Dular 2007, t. 19: 15).

V stavbi 1 sta bila v zgodnjersrednjeveški plasti najdena še dva odlomka okrašenega okova nožnice (*t. 26: 7–8*), ki ju lahko najbolje primerjamo z okovom v moškem grobu 28 v Bodeščah, ki je datiran v konec 8. in v 9. st. (Knific, Pleterski 1981, t. 10: gr. 28: 1).

### Knives and sheaths

In the area of building 1, a large number of various knives was found (*Pls. 23: 6–17; 24: 1–16; 25: 1–14; 26: 1–5; 27: 1–2*). Most were lying in layers of phase LA 2 (*Pls. 23: 9–10,13–14,17; 24: 2,7,10–11,13,15; 25: 2,5,10,12*), some were found in the inner (*Pl. 24: 5*) and outer (*Pls. 23: 9,16; 24: 8,14; 25: 4*) walking surface of building 1, in the destruction layer (*Pls. 23: 7–8; 24: 12; 25: 1,3*), and in the Early Medieval layer of the building (*Pl. 26: 2,3*) and of the outbuilding (*Pl. 26: 4–5*). Others (*Pls. 23: 6,11–12,15; 24: 3–4,6,9,16; 25: 6–9,13–14*) were found in mixed layers.

Small bent knives (*Pl. 25: 9–14*) were also used in medicine or cosmetics.

A knife with a clip-point blade (*Pl. 26: 1*, metal detector find) can be assigned to the 9<sup>th</sup> century. Excellent analogies for it can be found in male grave 43 in Bodešče which is dated to the end of the 8<sup>th</sup>–9<sup>th</sup> century (Knific, Pleterski 1981, Pl. 14: 6) and at Gradišče above Bašelj, where the objects are mostly dated between the beginning of the 9<sup>th</sup> and the first half of the 10<sup>th</sup> century (Bitenc, Knific 2001, cat. nos. 324, 325). A comparable knife was found also at a site close to Tonovcov grad, that is Sv. Volar above Robič (Knavs, Mlinar 2000–2004, 169).

The best analogies for parts of a sheath (*Pl. 26: 6*), which were found in the Early Medieval layer of building 1, are found at Ajdna above Potoki, where a few objects dated to the beginning of the 9<sup>th</sup> century were found in a building, in a layer above the destruction layer from the second half of the 6<sup>th</sup> century (Vidrih Perko, Sagadin 2004, 221, Fig. 10). Two similar but decorated sheaths were found at Gradišče above Bašelj, where they are dated to the beginning of the 9<sup>th</sup> or to the first half of the 10<sup>th</sup> century (Bitenc, Knific 2001, cat. no. 324). One sheath was found at Gradišče above Dešen (Pavlin, Dular 2007, Pl. 19: 15).

In building 1, two fragments of a decorated sheath (*Pl. 26: 7–8*) were found in the Early Medieval layer. The fragments can be best compared to the sheath found in male grave 28 in Bodešče, which is dated to the end of the 8<sup>th</sup> and the 9<sup>th</sup> century (Knific, Pleterski 1981, Pl. 10: gr. 28: 1).

### Goldsmith's tools?

Two tools with a spoon-shaped widened bottom part which at the end narrows into a massive tip could be punches for punching rings (*Pl. 19: 15–16; mixed layer*). Similar tools were also found at Korinjski hrib (Ciglenečki 1985, Pl. 4: 44), in house 5 at Rifnik (Bolta 1981, Pl. 24: 92), at Gradec near Prapretno (Bausovac 2003, Pl. 2: 13), at Invillino (Bierbrauer 1987, Pl. 166: 11–15), and at Runde Berg (Koch 1991, Pl. 10: 10). Tools of similar forms, where the spoon-shaped widened part narrows into a tip, are mostly interpreted as punches (Heindel 1993, 346–350). The tools from Korinjski hrib and some from Invillino do



## Zlatarsko orodje?

Dve orodji z žličasto razširjenim spodnjim delom, ki se na koncu zoži v masivno konico, sta morda punca za vtolčenje krožcev (*t. 19: 15–16*; premešana plast). Podobna orodja so bila najdena tudi na Korinjskem hribu (Ciglenečki 1985, t. 4: 44), v hiši 5 na Rifniku (Bolta 1981, t. 24: 92), na Gradcu pri Prapretnem (Bausovac 2003, t. 2: 13), na Invillinu (Bierbrauer 1987, t. 166: 11–15) in na Runde Bergu (Koch 1991, t. 10: 10). Orodja podobnih oblik, pri katerih se žličasto razširjeni del zoži v konico, so večinoma interpretirana kot punce (Heindel 1993, 346–350). Orodje s Korinjskega hriba in nekatera z Invillina pa se ne končajo s konico in so na prvi pogled bolj podobna vrsti dlet (*Hohlmeissel*), kakršno je na primer upodobljeno na verigi iz Szilágyosomylja (Cappele 1994, 41–42). Po drugi interpretaciji so bila orodja, ki se končajo votlo, uporabljana v zlatarstvu kot žličke za dodajanje majhne količine snovi (Szameit 1995, 250–251, t. 3: 6).

Tudi majhno železno kladivce (*t. 19: 4*), najdeno v premešani plasti, bi lahko spadalo k zlatarskemu orodju.

## Predmeti nejasnega namena

Železen predmet trapezaste oblike (*t. 28: 12*), najden v premešani plasti, bi bil lahko nož za rezanje usnja (Pietsch 1983, 78).

Kroglji svinčeni ploščici (*t. 28: 9–10*), ki sta ležali v premešani plasti, morda predstavljata uteži (ali igralni ploščici?).

Nekoliko deformiran železen predmet (*t. 26: 9*), najden v plasti faze PA1, bi bil lahko orodje za izvlačenje žebjev.

Viličasto orodje s tordiranim držalom (*t. 26: 10*), ki je ležalo v zgodnesrednjeveški plasti, približno spominja na velike vilice za jemanje kosov hrane iz kotla, vendar dobrih primerjav nismo našli, tako da ostaja njegov namen neznan. Podoben predmet, interpretiran kot vilice, je upodobljen skupaj z nožem na verigi iz Szilágyosomylja (Cappele 1994, 27–28).

Najdenih je bilo sedem železnih obročkov (*t. 28: 1–7*).

Železna konica z uvitima koncema (*t. 28: 8*), najdena v premešani plasti, ima prav tako neznan namen. V Gültlingenu je bilo najdeno tako oblikovano zložljivo orodje (Quast 1993, 77–84), na Invillinu pa del podobno oblikovanega predmeta (Bierbrauer 1987, t. 165: 6).

## MLAJŠA OBDOBJA

Z detektorjem kovin je bilo odkritih nekaj posrednjeveških predmetov: dve kladivi (*t. 29: 1–2*), kopača (*t. 29: 3*), naprstnik (*t. 29: 4*) in gumb (*t. 29: 5*).

not end with a tip and at first glance more resemble a type of chisels (Ger. *Hohlmeissel*), as is, for example, depicted on the chain from Szilágyosomylja (Cappele 1994, 41–42). According to a different interpretation tools ending hollow are used by goldsmiths as spoons for adding small amounts of substances (Szameit 1995, 250–251, Pl. 3: 6).

A small iron hammer (*Pl. 19: 4*) found in a mixed layer could also be assigned among goldsmith's tools.

## Objects of unclear purpose

An iron object of trapezoid shape (*Pl. 28: 12*) found in a mixed layer could be a knife for cutting leather (Pietsch 1983, 78).

Two round lead plates (*Pl. 28: 9–10*), which were lying in a mixed layer, could maybe be weights (or game tokens?).

A slightly deformed iron object (*Pl. 26: 9*) found in a layer of phase LA 1 could represent a tool for the pulling-out of nails.

Fork-shaped tool with a twisted handle (*Pl. 26: 10*), which was found in the Early Medieval layer, roughly resembles a large fork for taking pieces of food from a cauldron. Nevertheless, good comparisons were not found thus its purpose remains unknown. A similar object, interpreted as a fork, is depicted on the chain from Szilágyosomylja, along with a knife (Cappele 1994, 27–28).

Seven iron rings (*Pl. 28: 1–7*) were found.

An iron point with rolled endings (*Pl. 28: 8*), found in a mixed layer, also has an unknown purpose. In Gültlingen a folding tool of this shape was found (Quast 1993, 77–84) and at Invillino a part of a similarly shaped object (Bierbrauer 1987, Pl. 165: 6).

## LATER PERIODS

With the use of a metal detector a few post-Medieval objects were found: two hammers (*Pl. 29: 1–2*), a hoe (*Pl. 29: 3*), a thimble (*Pl. 29: 4*), and a button (*Pl. 29: 5*).

## CONCLUSION

Tools are chronologically and typologically difficult to delimit since they are mostly defined by use. Most of the tools were formed in the Late Iron Age or in the 1<sup>st</sup> century BC and have not significantly changed. Certain forms remain unchanged until the 20<sup>th</sup> century. Basic types of agricultural, blacksmith, stone-cutting, wood-processing and other tools were conclusively shaped during the Roman imperial period and were as such preserved also during the Late Antique period (Gaitsch 1980; Pietsch 1983; Pohanka 1986; Henning 1987).

In the area of building 1 two main groups of tools were found, the agricultural (sickle, share, coulter,

## SKLEP

Orodje je kronološko in tipološko težko opredeljivo, ker ga v največji meri opredeljuje uporabnost. Večina orodja se je oblikovala v pozni železni dobi oziroma v 1. stoletju pr. n. št. ter se je od takrat le malo spreminjala. Nekatere oblike ostajajo nespremenjene vse do 20. st. Bistvene vrste poljedeljskega, kovaškega, kamnoseškega orodja, orodja za obdelavo lesa in druge oblike so se dokončno oblikovale v rimskem cesarskem obdobju ter se kot take ohranile tudi v poznoantičnem času (Gaitszsch 1980; Pietsch 1983; Pohanka 1986; Henning 1987).

Na območju stavbe 1 sta ležali dve glavni skupini orodja, poljedeljsko (srp, lemež, črtalo, kosa: *t.* 12: 2–11; 13: 7; 14: 1–3; *sl.* 2.7) in za obdelavo lesa (svedri, sekire, orodja za dolbenje lesa: *t.* 13: 5–6; 14: 4–8; 15: 1–8). Poljedelstvo je bilo verjetno glavna gospodarska dejavnost, s katero so se preživljali prebivalci poznoantičnih višinskih naselbin. Glede na lego sredi gozdov ter glede na to, koliko stvari je bilo izdelanih iz lesa, pa pogostost orodja za obdelavo lesa ne preseneča (Gaspari et al. 2000, 200). Kot pri poljedeljskem orodju se je nabor tipov zmanjšal v primerjavi z rimskim obdobjem, vendar je ostalo kar nekaj vrst rezil za dolbenje in preoblikovanje lesa (Sagadin 2000).

Nekaj je predmetov, ki so se uporabljali pri hišnih opravilih, verjetno v vsakem gospodinjstvu: noži, šivanke, vretenca, železni glavniki, škarje, šila, okovi za vedra (*t.* 15: 9; 16: 1–25; 17: 1–32; 19: 1–14; 20: 1–10; 21: 1–14). Z železnimi glavniki in mikalniki (*t.* 15: 9; 16: 17) so razčesavali volno in lan, uporabljali so jih torej pri izdelavi tekstila. Vretenca, tako svinčena (*t.* 16: 10–15) kot keramična (*t.* 16: 18–25; 17: 1–5), kažejo, da so gospodinje predelovale volnena in na primer lanena vlakna, predle in tkale same.

Zanimiva skupina je pribor za tehtanje (tehtnice, uteži, novčna utež: *t.* 22: 1–2,4–13). Novčna utež (*t.* 22: 2) je za območje jugovzhodnih Alp precej nenavadna najdba, saj se predvideva, da je redni denarni obtok konec 4. st. oz. na začetku 5. st. tukaj bolj ali manj usahnil (Kos 2000, 110). Redki novci iz 5. in 6. st. so večinoma srebrniki in zlatniki, ki verjetno niso bili uporabljani v vsakodnevnih transakcijah. Vendar pa veliko število novcev manjše vrednosti iz časa 1.–4. st. na poznoantičnih naselbinah dopušča domnevo, da so se kot drobiž lahko uporabljali tudi v pozni antiki (glej pogl. 5.2).

Težko je predvideti, koliko pribor za tehtanje kaže na trgovanje. Tehtnice so lahko služile pri trgovini na kratke ali dolge razdalje. Keramične in steklene najdbe (glej pogl. 3.6 in 4.1) jasno kažejo, da je trgovina s Sredozemljem in Italijo še delovala, četudi v precej okrnjeni obliki.

Na specializirano obrt, na primer zlatarstvo oziroma izdelavo bronastih okrasnih izdelkov, bi kazali malo klavdice (*t.* 19: 4) in puncni ali zlatarski žlički (*t.* 19: 15–16), pa tudi veliko število starih bronastih predmetov, najdenih na območju stavbe 1, ki so bili lahko

scythe: *Pls.* 12: 2–11; 13: 7; 14: 1–3; *Fig.* 2.7) and for the processing of wood (augers, axes, tools for chiselling-out wood: *Pls.* 13: 5–6; 14: 4–8; 15: 1–8). Agriculture was probably the main economic activity which ensured the survival for the inhabitants of the Late Antiquity hilltop settlements. Considering the location amidst forests and the amount of products made of wood the frequency of tools for wood processing is not surprising (Gaspari et al. 2000, 200). As with the agricultural tools the range of types decreased in comparison to the Roman period, still quite many types of blades for chiselling and reshaping of wood persisted (Sagadin 2000).

There are some objects used around probably every house while performing chores: knives, needles, spindle-whorls, iron combs, scissors, awls, and fittings for buckets (*Pls.* 15: 9; 16: 1–25; 17: 1–32; 19: 1–14; 20: 1–10; 21: 1–14). Iron combs and carders (*Pls.* 15: 9; 16: 17) were used to comb wool and flax, therefore, they were used in the production of fabric. Spindle-whorls, both lead (*Pl.* 16: 10–15) and pottery (*Pls.* 16: 18–25; 17: 1–5), show that women were processing wool and, for example, flax fibres, they were spinning and weaving on their own.

An interesting group is assembled of weighing equipment (steelyard, weights, acoin weight: *Pl.* 22: 1–2,4–13). The coin weight (*Pl.* 22: 2) is a fairly unusual find for the area of the Southeastern Alps since it is believed that the regular circulation of money practically ceased here at the end of the 4<sup>th</sup> or the beginning of the 5<sup>th</sup> century (Kos 2000, 110). Rare coins of the 5<sup>th</sup> and 6<sup>th</sup> century are mostly silver or golden, which were probably not used in the every day transactions. Still a great number of coins of smaller value from the time of the 1<sup>st</sup>–4<sup>th</sup> century at the Late Antique settlements allows for the possibility that these could have been used as small change also during the Late Antiquity (see chapter 5.2).

It is difficult to predict to what extent the weighing equipment indicates trading. The steelyards could have been used for trading on short or long distances. Pottery and glass finds (see chapters 3.6 and 4.1) clearly show that trade continued with the Mediterranean and Italy, even if in a relatively downgraded form.

A small hammer (*Pl.* 19: 4) and two punches or goldsmith spoons (*Pl.* 19: 15–16), also a great number of old bronze objects found in the area of building 1 which could be intended for further processing, indicate the specialised craft, for example goldsmith's workshop or manufacturing of bronze decorative objects. Several such finds were discovered in the area of buildings 2 and 3 (see chapter 2.2).

In the area of building 3 at Tonovcov grad a half-finished necklace clasp (*Pl.* 45: 3) was found. Traces of manufacturing ornamental and useful products are present also at other settlements of the Southeastern Alps. Several sites in Slovenia and Austrian Carinthia

namenjeni nadaljnji predelavi. Več tovrstnih najdb je bilo najdenih na območju stavb 2 in 3 (glej pogl. 2.2).

Na območju stavbe 3 na Tonovcovem gradu je bil najden polizdelek sponke za verižico (*t. 45: 3*). Tudi na drugih jugovzhodnoalpskih naselbinah srečamo sledove izdelovanja okrasnih in uporabnih predmetov. Na nekaj najdiščih v Sloveniji in na avstrijskem Koroškem so bili najdeni modeli ali polizdelki fibul ter model za ulivanje fibule. Na Sv. Lambertu nad Pristavo pri Stični je bila najdena nedokončana ploščata križna fibula iz bronaste pločevine (Cipot 2003, 21, kat. 5), na Zidanem gabru nad Mihovim srebrn polizdelek (neobdelan ulitek) S-fibule (Knific 2001, kat. 263; Milavec 2007, t. 3: 10), na Vipoti nad Pečovnikom svinčen model ptičje fibule in srebrn ingot (Pirkmajer 2001, kat. 158; Karo 2001, kat. 239), na Sv. Hemi na Koroškem pa del glinenega modela za ulivanje ptičje fibule v obliki petelina ter tudi ustrezna fibula (Schretter 1993, 195–198, sl. 8: 14–15).

Nekoliko preseneča v območju stavbe 1 najdenih šest železnih stilusov (*t. 18: 5–10*), za katere predvidevamo, da so jih uporabljali v 5. in 6. stoletju. Nekaj jih je bilo najdenih na primer tudi na Invillinu (Bierbrauer 1987, t. 57: 9–13), eden na Gradcu pri Veliki Strmici (Klasinc 1999, kat. 21), eden v Kopru (Cunja 1996, t. 2: 26) in štirje na Sv. Hemi (Ladstätter 2000, t. 34: 42–45), zagotovo pa ne predstavljajo tipične najdbe obravnavanega obdobja, saj pismenost takrat ni bila pogosta.

### 2.1.6 STAVBNO ŽELEZO

Med prepoznavne dele hišne opreme, najdene na območju stavbe 1, štejemo dele ključavnic in zapahov, ključe, tečaje, okove, skobo, spojke in žeblje (*t. 30–39*). Ključi, zapah skrinje in tečaji, ki so bili najdeni večinoma v plasti notranje in zunanje hodne površine stavbe 1 (*t. 30: 12,20; 31: 6,21; 32: 3–4; 33: 1,11*) in so predvidoma sestavljali del njenega inventarja v času njene uporabe, so kartirani na sl. 2.9.

Najdenih je bilo 13 zapahov (*t. 30: 1–11,14–15*). Ležali so v plasteh PA 2 (*t. 30: 1,9,14*) in premešanih plasteh. Vsi spadajo k drsnim ključavnicam, ki so se zaklepale z drsnimi ključi. Zapah (*t. 30: 7*) je drugačne oblike, vendar ima isto funkcijo kot ostali. Njemu podobni in pripadajoče ključavnice so bili najdeni na primer na Rifniku (Bolta 1981, t. 19: 7–8,14–15) in Sadovcu (Uenze 1992, t. 34: 4–5).

Ključev je bilo 16 (*sl. 2.9; t. 30: 12–13,16–21; 31: 1–8*). Na območju stavbe 1 so bili najdeni v plasteh in hodnih površinah faze PA 2 (*t. 30: 12,17–18,20–21; 31: 4,7*) in v premešani plasti. Ključ (*t. 31: 8*) je preprost kavljast, dva sta sidrasta oz. v obliki črke L (*t. 30: 12,16*), deset je drsnih (*t. 30: 13,19–21; 31: 1–6*), dva pa sta ključa v obliki prstana (*t. 30: 17–18*). Tudi bronast odlomek ročaja spada h ključu (*t. 31: 7*; prim. Bassi 1996, sl. 26: 10). Vse te oblike ključev so stare in so bile v uporabi celotno antično obdobje, tako

have revealed models or intermediate products of fibulae and a mould for fibula casting. On Sv. Lambert above Pristava near Stična an unfinished cross-shaped fibula made of bronze sheet (Cipot 2003, 21, cat. no. 5) was found, at Zidani gaber above Mihovo a silver intermediate product (unfinished casting) of an S-fibula (Knific 2001, cat. no. 263; Milavec 2007, Pl. 3: 10) was discovered, at Vipota above Pečovnik lead model of a bird fibula and a silver ingot (Pirkmajer 2001, cat. no. 158; Karo 2001, cat. no. 239) were found, at Hemmaberg in Carinthia a piece of a clay mould for casting a bird fibula in the shape of a rooster and the corresponding fibula (Schretter 1993, 195–198, Fig. 8: 14–15) were found.

Six iron styli (*Pl. 18: 5–10*) found in the area of building 1 are somewhat surprising and we suppose that they were used in the 5<sup>th</sup> and 6<sup>th</sup> century. Some were also found at, for example, Invillino (Bierbrauer 1987, Pl. 57: 9–13), one at Gradec near Velika Strmica (Klasinc 1999, cat. no. 21), one in Koper (Cunja 1996, Pl. 2: 26), and four at Hemmaberg (Ladstätter 2000, Pl. 34: 42–45). Most certainly these do not represent a typical find of the discussed period when literacy was not very frequent.

### 2.1.6 ARCHITECTURAL FITTINGS

Parts of locks and lock bolts, keys, hinges, fittings, staples, clamps, and nails (*Pls. 30–39*) belong among the recognisable pieces of architectural fittings found in the area of building 1. Keys, a chest bolt, and hinges which were found mostly in the inner and outer walking surface of the building (*Pls. 30: 12,20; 31: 6,21; 32: 3–4; 33: 1,11*) and are supposedly part of the building 1 inventory during its functioning, are mapped on *Fig. 2.9*.

13 bolts (*Pl. 30: 1–11,14–15*) were discovered. They were found in layers of phase LA 2 (*Pl. 30: 1,9,14*) and mixed layers. All belong to pin tumbler locks which were locked by pin tumbler keys. The bolt (*Pl. 30: 7*) is of a different form but performs the same function as the others. Similar bolts as this one and the corresponding locks were found at, for example, Rifnik (Bolta 1981, Pl. 19: 7–8,14–15) and Sadovec (Uenze 1992, Pl. 34: 4–5).

There were 16 keys (*Fig 2.9; Pls. 30: 12–13,16–21; 31: 1–8*). In the area of building 1 they were found in the layers and walking surfaces of phase LA 2 (*Pls. 30: 12,17–18,20–21; 31: 4,7*) and in a mixed layer. The key (*Pl. 31: 8*) is a simple latch lifter, two are anchor- or L-shaped latch lifters (*Pl. 30: 12,16*), ten are pin tumbler (*Pls. 30: 13,19–21; 31: 1–6*), and two are ring keys (*Pl. 30: 17–18*). The bronze handle fragment (*Pl. 31: 7*; cf. Bassi 1996, Fig. 26: 10) also belongs to a key. All these key shapes are old and remain in use throughout the entire Antiquity thus they cannot be typologically precisely dated. But since they were lying in the layers of phase LA 2 we assume that they belonged to building 1 and are thus assigned to approximately 6<sup>th</sup> century.

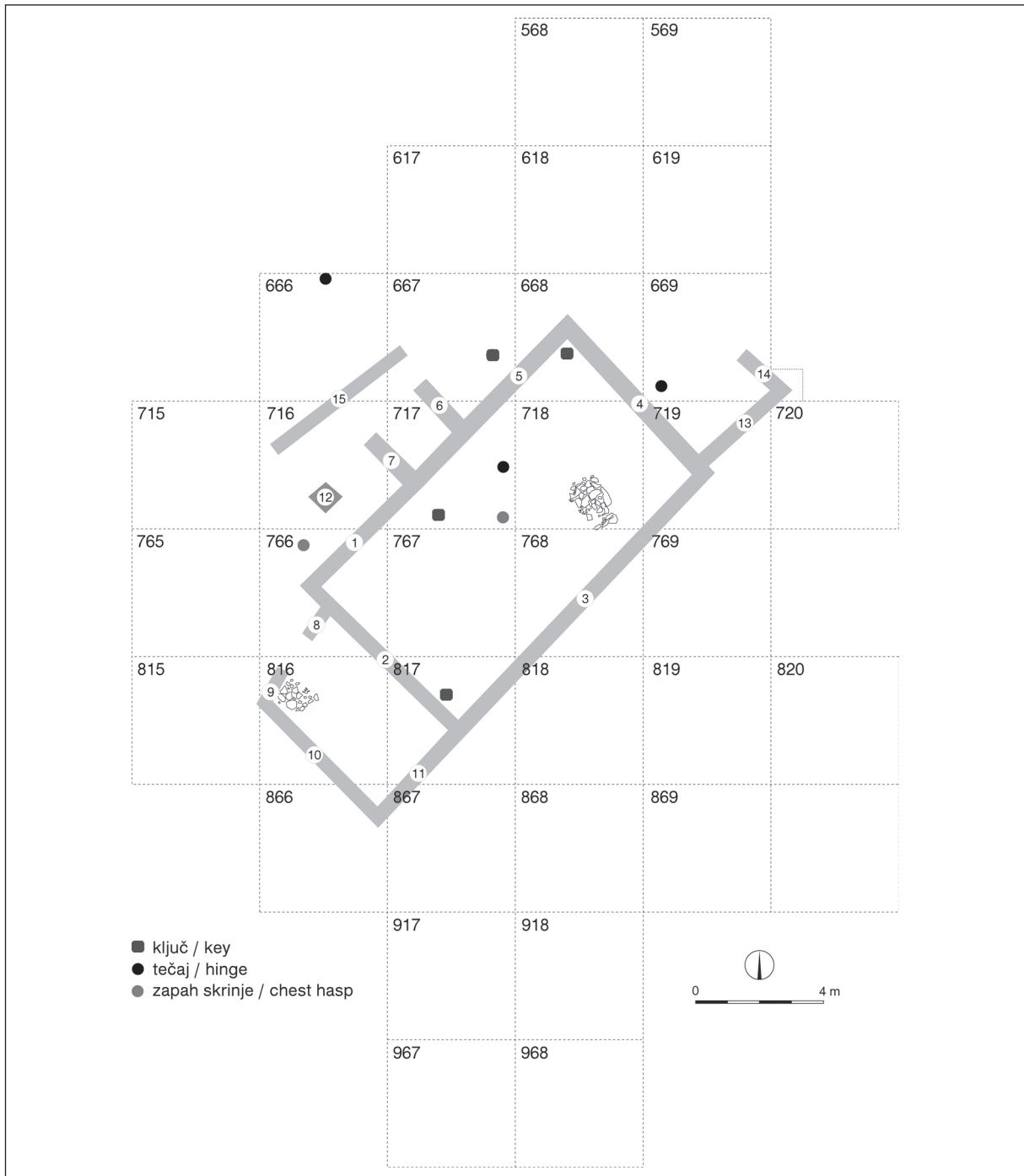

Sl. 2.9: Karta razprostranjenosti stavbne opreme v izkopnem polju stavbe 1 (hodne površine faze PA 2).  
 Fig. 2.9: Distribution of architectural fittings in the excavation area of building 1 (walking surfaces of phase LA 2).

da jih tipološko ne moremo natančno časovno opredeliti. Ker pa ležijo v plasteh faze PA 2, sklepamo, da so pripadali stavbi 1, in jih datiramo okvirno v 6. st.

Ključča v obliki prstana (*t. 30: 17-18*) sta bila najdena v plasteh faze PA 2. Takšni ključči so se pojavili na začetku rimskega obdobja (Schütz 2003, 115), posebej priljubljeni so bili v 3. stoletju (Riha 1990, 39-41), niso pa pogosta poznoantična najdba.

Two ring keys (*Pl. 30: 17-18*) were discovered in layers of phase LA 2. Such keys appear at the beginning of the Roman period (Schütz 2003, 115) and are especially popular in the 3<sup>rd</sup> century (Riha 1990, 39-41). In Late Antiquity they are not a frequent find.

Besides the recognisable keys another five iron fragments were found in a mixed layer which most probably belong to key grips (*Pl. 31: 9-13*).

Poleg razpoznavnih ključev je bilo v premešani plasti najdenih še pet železnih odlomkov, ki so najverjetneje odlomki držajev ključev (*t. 31: 9–13*).

Zunaj stavbe 1 je bilo najdenih 22 odlomkov razcepnih tečajev (*t. 32: 3–21*). Eden je bil najden v plasti PA 1 (*t. 32: 17*) in bi torej lahko pripadal starejšemu objektu na tem mestu. Ostali so ležali v plasteh faze PA 2 (*t. 32: 3–4,9,11,15–16,18,20*) in premešanih plasteh.

Nekaj je bilo okovov oziroma masivnih tečajev (*t. 33: 1–3,12*). Tečaja (*t. 33: 3,12*) sta bila najverjetneje pritrjena na vrata (Schütz 2003, 140, t. 43: S202). Prvi (*t. 33: 3*) je bil najden v plasti faze PA 1, drugi (*t. 33: 12*) pa je naključna najdba. Del okovja (*t. 32: 22*) lahko interpretiramo kot nosilec vratnega tečaja (Schütz 2003, 140–141, t. 43: S197–S200).

Najdena sta bila tudi dva dela zapiralnega sistema skrinj (*sl. 2.9; t. 33: 10–11*: prim. Cavada 1996, 97–99; Deimel 1987, t. 39: 3). Eden (*t. 33: 11*) je ležal v plasti notranje hodne površine stavbe 1 skupaj s tečajem (*t. 33: 1*) in ključem (*t. 30: 21*), drugi (*t. 33: 10*) je bil najden v plasti zunanje hodne površine stavbe 1.

Okrašen bronast okov (*t. 32: 2*) je zelo verjetno del okrasa manjše skrinjice, najden je bil v premešani plasti (prim. npr. Deimel 1987, t. 98).

Od predmetov, ki so povezovali lesene dele objekta, lahko z gotovostjo prepoznamo le eno skobo, ki je bila najdena v ruševini (*t. 33: 4*), in pet spojka (*t. 33: 5–9*). Ležale so v plasti faze PA 2 (*t. 33: 9*) in premešani plasti.

Odkrito je bilo veliko žebeljev (*t. 34–39*). Večina jih je srednje velikosti (dolžine okrog 5 cm), s ploščato ali včasih masivno, piramidalno glavo (*t. 35: 7,9–10,13–24; 36: 1–27,31–32,34,38,40; 37: 1–33; 38: 1–35*). Nekaj jih je večjih (do 20 cm; *t. 34: 1–14; 35: 1–6,8,11–12*), najdenih pa je bilo tudi precej zelo majhnih žebeljčkov enotne dolžine malo več kot 1 cm (*t. 36: 28–30,33,35,37,39,41; 39: 1–75*). Prostorsko so bili razporejeni precej enakomerno, po približno 1 do 7 primerkov v večini kvadrantov, v ruševinski plasti in drugih plasteh faze PA 2. Le nekaj jih izvira iz plasti faze PA 1 (glej Tonovcov grad. Naselbinski ostanki in interpretacija, sl. 3.2: 4–5; 3.3: 5–6; 3.4: 15–16; 3.8: 6–9; 3.10: 2) in iz plasti, ki pripadajo zgodnesrednjeveškemu obdobju (glej Tonovcov grad. Naselbinski ostanki in interpretacija, sl. 3.17: 4; 3.19: 6–10,12–14).

Večja koncentracija žebeljev je bila v kvadrantih v okolici stavbe ob zidovih 4 in 5 (med 7–12 primerkov v kvadrantih 617, 618, 619, 668, 669) in predvsem v kvadrantu 666 tik pred vhodom v stavbo, kjer je bilo najdenih 40 žebeljev vseh velikosti. Manjša koncentracija jih je bila tudi v plasti faze PA 2 v kvadrantu 817/A2, ki leži v notranjem vogalu prizidka (med zidovoma št. 2 in 11). Tam je bilo najdenih šest žebeljčkov samo najmanjše velikosti (približno 1 cm; *t. 39: 23,32–34,51–52*). Zraven je bil najden tudi ključ v obliki sidra (*t. 30: 12*). Povsem mogoče je, da so to ostanki skrinjice.

Outside building 1, 22 fragments of split hinges (*Pl. 32: 3–21*) were found. One was discovered in layer LA 1 (*Pl. 32: 17*) and could therefore belong to the earlier building in the same spot. Others lay in layers of phase LA 2 (*Pl. 32: 3–4,9,11,15–16,18,20*) and in mixed layers.

There were a few fittings or massive hinges (*Pl. 33: 1–3,12*). Two hinges (*Pl. 33: 3,12*) were probably attached to a door (Schütz 2003, 140, Pl. 43: S202). The first (*Pl. 33: 3*) was found in a layer of phase LA 1, while the other (*Pl. 33: 12*) is a chance find. The part of a frame (*Pl. 32: 22*) can be interpreted as a door hinge pin (Schütz 2003, 140–141, Pl. 43: S197–S200).

Two chest or casket hasps (*Fig 2.9; Pl. 33: 10–11*: cf. Cavada 1996, 97–99; Deimel 1987, Pl. 39: 3) were also found. One (*Pl. 33: 11*) lay in the walking surface of building 1, together with a hinge (*Pl. 33: 1*) and a key (*Pl. 30: 21*), and the other (*Pl. 33: 10*) was found in the outer walking surface of building 1.

A decorated bronze fitting (*Pl. 32: 2*) is most probably part of the decoration of a casket and was found in a mixed layer (cf. e.g. Deimel 1987, Pl. 98).

Among the objects which were used to connect the wooden parts of buildings we can certainly identify only one staple found in the destruction layer (*Pl. 33: 4*), and five clamps (*Pl. 33: 5–9*). They were lying in layers of phase LA 2 (*Pl. 33: 9*) and in a mixed layer.

Many nails were found (*Pl. 34–39*). Most are of medium size (approximately 5 cm long) with a flat or sometimes massive, pyramidal head (*Pls. 35: 7,9–10,13–24; 36: 1–27,31–32,34,38,40; 37: 1–33; 38: 1–35*). A few are bigger (up to 20 cm; *Pls. 34: 1–14; 35: 1–6,8,11–12*) but there were also several very small nails found which are all of the same length, slightly over 1 cm (*Pls. 36: 28–30,33,35,37,39,41; 39: 1–75*). They are evenly distributed over the area, approximately 1 to 7 nails per most quadrants, in the destruction layer and other layers of phase LA 2. Only a few pieces originate from layers of phase LA 1 (see Tonovcov grad. Settlement remains and interpretation, Figs. 3.2: 4–5; 3.3: 5–6; 3.4: 15–16; 3.8: 6–9; 3.10: 2) and from layers belonging to the Early Medieval period (see Tonovcov grad. Settlement remains and interpretation Figs. 3.17: 4; 3.19: 6–10,12–14).

A bigger concentration of nails is noticeable in quadrants around the building, along walls 4 and 5 (between 7 and 12 nails in qus. 617, 618, 619, 668, 669), and especially in qu. 666, immediately in front of the building entrance where 40 nails of all sizes were found. A smaller concentration is also found in a layer of phase LA 2, in qu. 817/A2, which is located in the inner corner of the outhouse (between walls nos. 2 and 11). Six nails of the smallest size were found there (approximately 1 cm; *Pl. 39: 23,32–34,51–52*). An anchor-shaped latch lifter (*Pl. 30: 12*) was found alongside. It is quite possible that these are the remains of a casket.

## SKLEP

K zapiralnim sistemom vrat, skrinj in skrinjic spada še precej delov (na primer okovi ključavnic, tečaji in okrasni okovi skrinj ipd.), vendar nam je med gradivom z območja stavbe 1 uspelo zanesljivo razpoznati le zgoraj naštetete dele. Zapiralni sistemi in ključi so bili lahko tudi leseni, v tem primeru se niso ohranili.

V plasteh faze PA 1 (druga polovica 4. st. in začetek 5. st.) sta bila najdena dva kosa tečajev (*t. 32: 17; 33: 3*) in nekaj žebeljev (*t. 37: 11,13,18–19,22–23; 38: 3,9,11; 39: 25,39,48,62*; glej Tonovcov grad. Naselbinski ostanki in interpretacija, sl. 3.2: 4–5; 3.3: 5–6; 3.4: 14–16; 3.8: 6–9; 3.10: 2), ki so lahko pripadali pozno-rimskemu objektu.

Z vhodnimi vrati stavbe 1 ali s skrinjo, ki ji je pripadal del zapaha (*t. 33: 11*), sta lahko povezana ključ (*t. 30: 21*) in okov ali tečaj (*t. 33: 1*), saj so ležali skupaj na hodni površini znotraj stavbe pred vhodom (*sl. 2.9*). Še dva ključa sta bila najdena v notranjosti stavbe in prizidka. Mali bronasti ključek (*t. 31: 6*) je ležal v severnem vogalu hiše, poškodovan železen (*t. 30: 12*) pa s skupkom majhnih žebeljčkov (*t. 39: 23,32–34,51–52*) v vogalu prizidka (med zidovoma 2 in 11). Lahko so bili ostanek obite skrinjice.

Pred zidom št. 5 je nekaj predmetov ležalo precej skupaj v ruševinski plasti faze PA 2 (SE 26): ključ v obliki prstana (*t. 30: 17*), tečaji (*t. 32: 11,15,18*) in spojka (*t. 33: 9*).

Oblika osnovnih delov hišne opreme se v antiki ni veliko spreminjala. Na Tonovcovem gradu zastopane oblike so večinoma prisotne že od mlajše železne dobe dalje, predvsem pa celotno rimsko in pozno-rimsko obdobje (Schütz 2003, 97–98). Na območju stavbe 1 so sočasno zastopani različni sistemi zaklepanja vrat oz. skrinj ali skrinjic. Tako na primer ključa v obliki črk T ali L (*t. 30: 12,16*; tudi t. i. ključ v obliki sidra) pripadata drugačnemu zapiralnemu sistemu kot drsni ključi (*t. 30: 13,19–21; 31: 1–5*), ki so povezani z deli drsni ključavnic (Schütz 2003, 88–122; sl. 34, 45). Mali bronasti ključek (*t. 31: 6*) in oba železna ključa v obliki prstana (*t. 30: 17–18*) so verjetno zaklepali manjše skrinjice.

## 2.1.7 TOALETNI PRIBOR

Najdeni sta bili dve bronasti (*t. 40: 6–7*) in dve železni pinceti (*t. 40: 8–9*). Dve (*t. 40: 7–8*) sta ležali v plasti zunanje hodne površine stavbe, ena pinceta (*t. 40: 6*) v plasti faze PA 2 in druga (*t. 40: 9*) v premešani plasti. Bronasti pinceti predstavljata eno najpogostejših oblik pincete (rahlno razširjena kraka), ki se je lahko uporabljala v kozmetične ali zdravstvene namene, uporabljali pa so jo od 1. stoletja dalje po celem rimskem imperiju (Riha 1986, 37: varianta G). Ta oblika je bila zelo pogosta tudi v pozni antiki, tudi v železni različici, kot na primer ena od železnih pincet (*t. 40: 9*). Druga

## CONCLUSION

Closing systems of doors, chests, and caskets involve numerous other parts (e.g. lock plates, hinges and ornamental fittings of caskets etc.) yet among the material from the area of building 1 we managed to certainly recognise only objects enumerated above. Security systems and keys were also made of wood and have thus not been preserved.

Layers of phase LA 1 (second half of the 4<sup>th</sup> and the beginning of the 5<sup>th</sup> century) reveal two hinges (*Pls. 32: 17; 33: 3*) and a few nails (*Pls. 37: 11,13,18–19,22–23; 38: 3,9,11; 39: 25,39,48,62*; see Tonovcov grad. Settlement remains and interpretation, Figs. 3.2: 4–5; 3.3: 5–6; 3.4: 14–16; 3.8: 6–9; 3.10: 2), which could have belonged to the Late Roman building.

A key (*Pl. 30: 21*) and a fitting or a hinge (*Pl. 33: 1*) could be connected to the entrance gate of building 1 or to a chest, to which belonged part of a bolt (*Pl. 33: 11*), since they were found lying together in the walking surface within the building, in front of the entrance (*Fig. 2.9*). Another two keys were found within the building and the outhouse. A small bronze key (*Pl. 31: 6*) lay in the northern corner of the house, while a damaged iron one (*Pl. 30: 12*) was found together with a group of small nails (*Pl. 39: 23,32–34,51–52*) in the corner of the outhouse (between walls 2 and 11). These could be the remains of a small studded casket.

In front of the wall no. 5, a few items lay quite close together in the destruction layer of phase LA 2 (SU 26): a ring key (*Pl. 30: 17*), hinges (*Pl. 32: 11,15,18*), and a clamp (*Pl. 33: 9*).

The shape of the basic parts of house equipment did not change significantly during the Antiquity. Shapes represented at Tonovcov grad are mostly present from the Late Iron Age onwards, and are especially frequent during the entire Roman and Late Roman period (Schütz 2003, 97–98). In the area of building 1 various systems of locking the doors or chests and caskets are represented simultaneously. Thus, for example, the keys in the shape of letters T or L (*Pl. 30: 12,16*; also called anchor-shaped keys or latch lifters) belong to a different closing system than pin tumbler keys (*Pls. 30: 13,19–21; 31: 1–5*), which are connected to parts of pin tumbler locks (Schütz 2003, 88–122; Figs. 34, 45). A small bronze key (*Pl. 31: 6*) and both iron ring keys (*Pl. 30: 17–18*) were probably used to lock caskets.

## 2.1.7 TOILET INSTRUMENTS

Two bronze (*Pl. 40: 6–7*) and two iron tweezers (*Pl. 40: 8–9*) were found. Two (*Pl. 40: 7–8*) lay in the outer walking surface of the building, one tweezers (*Pl. 40: 6*) in the layer of phase LA 2, and one (*Pl. 40: 9*) in a mixed layer. Bronze tweezers represent one of the most frequent forms (slightly widened levers) that could have

železna pinceta (z enakomerno širokima krakoma; *t. 40: 8*) se je prav tako pojavljala v rimskem obdobju, vendar tudi že v prazgodovini. V svetolucijski skupini se tovrstne (bronaste) pincete najdejo med obeski na ločnih fibulah (npr. Teržan, Lo Schiavo, Trampuž-Orel 1985, grob 705). Natančnejše časovne opredelitve ti predmeti ne omogočajo.

Majhen bronast odlomek (*t. 40: 10*) verjetno predstavlja del ogledala, najden je bil v premešani plasti.

Najdeni so bili štirje glavniki oziroma odlomki glavnikov iz rogovine (*t. 40: 11-12,18,21*) z dvema vrstama zobcev (eno gostejšo in eno redkejšo), ki so ležali v plasteh faze PA 1.

Dva sta večja, vezne prečke so okrašene s prekrizanimi enojnimi in dvojnimi vrezji (*t. 40: 11-12*), dva pa sta manjša, bolj fragmentarno ohranjena in neokrašena (*t. 40: 18,21*).

Od glavnikov iz faze PA 2 (*t. 40: 13-15,17,23,25-26*) in premešanih plasti (*t. 40: 16,19,20,22,24,27*) je en odlomek majhen in neokrašen (*t. 40: 15*), drugi (*t. 40: 20*) je del osnove glavnika, tretji (*t. 40: 19*) pa odlomek osnove z okrasom prečnih vrezov. Dva odlomka glavnikov s tankimi veznimi prečkami sta okrašena na eni strani s krožci s piko in na drugi strani s prečnimi vrezji (*t. 40: 13-14*). Sedem drobnih odlomkov letvic je neokrašenih (*t. 40: 17,22-27*). Odlomki celih, nepreluknjanih letvic dajejo misliti na izdelavo glavnikov (*t. 40: 22-24,27*).

Rogovinasti glavniki so se v rimskem imperiju začeli pojavljati šele v poznem 3. st. in predvsem od 4. st. dalje. Pred tem so bili večinoma izdelani iz lesa in se razen izjemoma niso ohranili (Riha 1986, 20). Zelo pogosti so med 4. in 7. st., natančneje pa jih, razen kadar so najdeni v dobro datiranih kontekstih, ne moremo opredeliti (Riemer 2000, 203). V Sloveniji jih je bilo največ najdenih na grobiščih v Dravljah in na Lajhu v Kranju ter v višinskih naselbinah, torej v času druge polovice 5. in 6. st. (Slabe 1975, t. 7: 4; 8: 3; 10: 5; 17: 1; Vinski 1980, 22-23).

Izdelovali so jih najverjetneje v naselbinah, kar lahko potrdijo najdbe z Ajdovskega gradca nad Vranjem (Bitenc, Knific 2001, kat. 143) in morda koščki prečk s Tonovcovega gradu (*t. 40: 22-24,27*).

Odkriti so bili štirje žeblički za obuvala (*t. 40: 1-4*; Bavdek 2005, t. 5: 2; 8: 10; 10: 4; Istenič 2005, 81, sl. 5: 1-13) in preprosta žičnata sponka (*t. 40: 5*). Ležali so v plasteh faze PA 2 (*t. 40: 3*) in v premešani plasti (*t. 40: 1-2,4-5*).

### 2.1.8 BRONASTO POSODJE

Na območju stavbe 1 so bili v premešani plasti najdeni bronasti deli ataš (*t. 41: 1-3*), dno posode (*t. 41: 6*), del posode (*t. 41: 4*), del ročaja (*t. 41: 8*; prim. Deimel 1987, t. 9: 2) in noga posode (*t. 41: 5*; prim. Deimel 1987, t. 11: 6). Poleg teh je bilo v plasteh faze

been used for cosmetic or medicinal purposes and appear from the 1<sup>st</sup> century onwards in the entire Roman Empire (Riha 1986, 37: variant G). This form is also very frequent during the Late Antiquity, also in the iron variant, as for example one of the iron tweezers (*Pl. 40: 9*). The other iron tweezers (with equally wide levers; *Pl. 40: 8*) also appears in the Roman period but also in the prehistory. In the Sveta Lucija group such tweezers (bronze) are found among the pendants on the bow fibulae (e.g. Teržan, Lo Schiavo, Trampuž-Orel 1985, grave 705). These objects do not enable a more precise dating.

A small bronze fragment (*Pl. 40: 10*) probably represents part of a mirror, it was found in a mixed layer.

Four combs or fragments of combs made of antler (*Pl. 40: 11-12,18,21*) with two rows of teeth (one thicker and one thinner; double-sided combs) were found lying in the layers of phase LA 1.

Two are bigger, connecting plates are decorated by crossed single and double incisions (*Pl. 40: 11-12*). Two are smaller, more fragmentarily preserved and undecorated (*Pl. 40: 18,21*).

Among combs from phase LA 2 (*Pl. 40: 13-15,17,23,25-26*) and the mixed layers (*Pl. 40: 16,19-20,22,24,27*), one fragment is small and undecorated (*Pl. 40: 15*), another (*Pl. 40: 20*) is part of the tooth plate, and a third (*Pl. 40: 19*) is a fragment of a tooth plate and a connecting plate with the decoration of diagonal incisions. Two fragments of combs with narrow connecting plates are on one side decorated by ring-and-dots and on the other side by diagonal incisions (*Pl. 40: 13-14*). Seven small fragments of connecting plate blanks are unornamented (*Pl. 40: 17,22-27*). Fragments of whole, imperforated blanks indicate the manufacturing of combs (*Pl. 40: 22-24,27*).

Antler combs appear in the Roman Empire only during the late 3<sup>rd</sup> century and mostly from the 4<sup>th</sup> century on. Prior to this time they were mostly made of wood and are generally not preserved (Riha 1986, 20). Antler combs are very frequent between the 4<sup>th</sup> and 7<sup>th</sup> century but cannot be more precisely delimited, except if found in well dated contexts (Riemer 2000, 203). In Slovenia, the most were found at cemeteries in Dravlje and at Lajh in Kranj, and at hilltop settlements, thus in the time of the second half of the 5<sup>th</sup> and 6<sup>th</sup> century (Slabe 1975, Pls. 7: 4; 8: 3; 10: 5; 17: 1; Vinski 1980, 22-23).

They were most probably manufactured at the settlements themselves, as is indicated by the finds from Ajdovski gradec above Vranje (Bitenc, Knific 2001, cat. no. 143) and possibly by pieces of connecting plates from Tonovcov grad (*Pl. 40: 22-24,27*).

Four nails for sandals (*Pl. 40: 1-4*; Bavdek 2005, Pls. 5: 2; 8: 10; 10: 4; Istenič 2005, 81, Fig. 5: 1-13) and a simple wire clamp (*Pl. 40: 5*) were discovered. These lay in the layers of phase LA 2 (*Pl. 40: 3*) and in a mixed layer (*Pl. 40: 1-2,4-5*).

PA 2 (*t. 41: 9–11, 13–14, 17–18; t. 42: 1, 7, 9, 11, 15–24, 26*), zgodnj srednjeveški plasti (*t. 42: 12, 25*) in premešani plasti najdenih tudi veliko kosov preluknjane bronaste pločevine (*t. 41: 7, 9–19; 42: 1–26*). S takimi koščki so popravljali predmete iz bronaste pločevine, na primer posode in kotle. Nekateri odlomki bronaste pločevine bi lahko bili tudi deli pasnih spon ali različnih okovov.

## 2.2 STAVBI 2 IN 3

Stavbi 2 in 3 sta med seboj povezani (glej Tonovcov grad. Naselbinski ostanki in interpretacija, pogl. 2.4), zato bosta obravnavani skupaj. V fazi PA 1 je bila zgrajena in uporabljana stavba 3. Ko je bila ta porušena, so enega od njenih zidov (SE 121) uporabili za gradnjo stavbe 2, območje prejšnje stavbe 3 pa je bilo, kot kažejo najdbe, uporabljano kot dvorišče ali gospodarski prostor (*sl. 1.3*).

Antične plasti na območju stavbe 3, preden je bila zgrajena, so datirane med 1.–3. st. (glej Tonovcov grad. Naselbinski ostanki in interpretacija, pogl. 3.2). V njih so bili najdeni dobro ohranjena močno profilirana fibula tipa Almgren 69 (*t. 45: 1; konec 1. in 2. st., Jobst 1975, 33*), srednje velik žebelj (*t. 46: 13*) in novec Avrelijana iz leta 272 (glej pogl. 5, kat. 22). V antični plasti na prostoru stavbe 2 je bil najden bronast okov (*t. 43: 5*), okrašen z vtolčenimi pikami, z eno ohranjeno železno zakovico.

V plasteh, ki sta prav tako starejši od ostankov zidov stavbe 3 (glej Tonovcov grad. Naselbinski ostanki in interpretacija, pogl. 3.2), sta bili najdeni valjasta zelena jagoda (*t. 45: 4, sl. 2.10: 1*) in majhna železna igla v obliki stilusa (*t. 45: 9; glej pogl. 2.1.2*).

Iz časa uporabe stavbe 3 v fazi PA 1 je malo najdb. V plasteh sta bila ploščat kamen, morda brus (*t. 45: 26*), ter železno orodje, morda oblič (*t. 46: 14*, Popović 1990, sl. 201).

V kulturni plasti faze PA 2 v stavbi 2 sta bila najdena del železnega tečaja (*t. 43: 12*) in železen okov (*t. 44: 3*), v plasti na zunanji strani južnega zidu (SE 123) stavbe 2 pa dva noža (*t. 43: 14, 16*). Železna okova za vedro (*t. 43:*

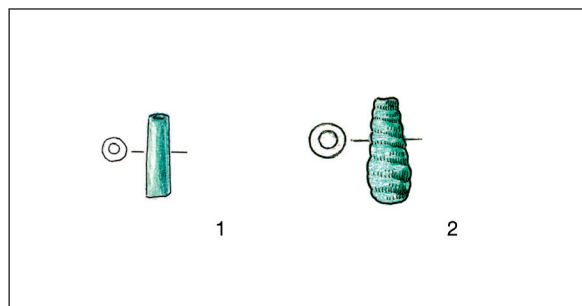

*Sl. 2.10: Jagodi iz stavbe 3 in groba 18 (t. 44: 23; 45: 4). Staklo. M. = 1:1.*

*Fig. 2.10: Beads from building 3 and grave 18 (Pls. 44: 23; 45: 4). Glass. Scale = 1:1.*

## 2.1.8 BRONZE VESSELS

In the area of building 1, in a mixed layer, bronze parts of suspension loops (*Pl. 41: 1–3*), a vessel base (*Pl. 41: 6*), a vessel part (*Pl. 41: 4*), a handle part (*Pl. 41: 8*; cf. Deimel 1987, Pl. 9: 2), and a vessel foot (*Pl. 41: 5*; cf. Deimel 1987, Pl. 11: 6) were found. Beside these, many pieces of perforated bronze sheet were discovered in the layers of phase LA 2 (*Pls. 41: 9–11, 13–14, 17–18; 42: 1, 7, 9, 11, 15–24, 26*), the Early Medieval layer (*Pl. 42: 12, 25*), and in the mixed layer (*Pls. 41: 7, 9–19; 42: 1–26*). Such pieces were used to repair objects made of bronze sheet, for example pots and cauldrons. Individual fragments of bronze sheet can also represent parts of belt buckles or various fittings.

## 2.2 BUILDINGS 2 AND 3

Buildings 2 and 3 are connected (see Tonovcov grad. Settlement remains and interpretation, chapter 2.4) thus they are here discussed together. In phase LA 1 building 3 was built and used. When this building was demolished, one of its walls (SU 121) was used in the construction of building 2, while the area of former building 3 was, as is indicated by the finds, used as a courtyard or work space (*Fig. 1.3*).

The Antique layers in the area of building 3 prior to its construction are dated between the 1<sup>st</sup> and the 3<sup>rd</sup> century (see Tonovcov grad. Settlement remains and interpretation, chapter 3.2). In them a well preserved fibula of the Almgren 69 type (*Pl. 45: 1; end of the 1<sup>st</sup> and the 2<sup>nd</sup> century, Jobst 1975, 33*), a medium-sized nail (*Pl. 46: 13*), and a coin of Aurelian from 272 AD (see chapter 5, cat. no. 22) were found. A bronze fitting (*Pl. 43: 5*) decorated by punched dots with one iron rivet preserved were found in the Antique layer in the area of building 2.

A cylindrical green bead (*Pl. 45: 4, Fig. 2.10: 1*) and a small iron pin shaped as a stylus (*Pl. 45: 9; see chapter 2.1.2*) were found in the two layers which are also older than the remains of walls of building 3 (see Tonovcov grad. Settlement remains and interpretation, chapter 3.2).

There are only few finds from the time of functioning of building 3 in phase LA 1. Here a flat stone, possibly a whetstone (*Pl. 45: 26*), and an iron tool, possibly a planer (*Pl. 46: 14*, Popović 1990, Fig. 201) were found.

In the cultural layer of phase LA 2 in building 2, a part of an iron hinge (*Pl. 43: 12*) and an iron fitting (*Pl. 44: 3*) were found. In the layer on the outer side of the southern wall (SU 123) of building 2, two knives (*Pl. 43: 14, 16*) were found. Two iron fittings for a bucket (*Pl. 43: 7–8*) and a bronze necklace link (*Pl. 43: 3*) were found among the stones of the northern wall (SU 121). An iron object, which could represent a small anvil (*Pl. 43: 6*), was found in the pit of phase LA 2, next to wall SU 122.



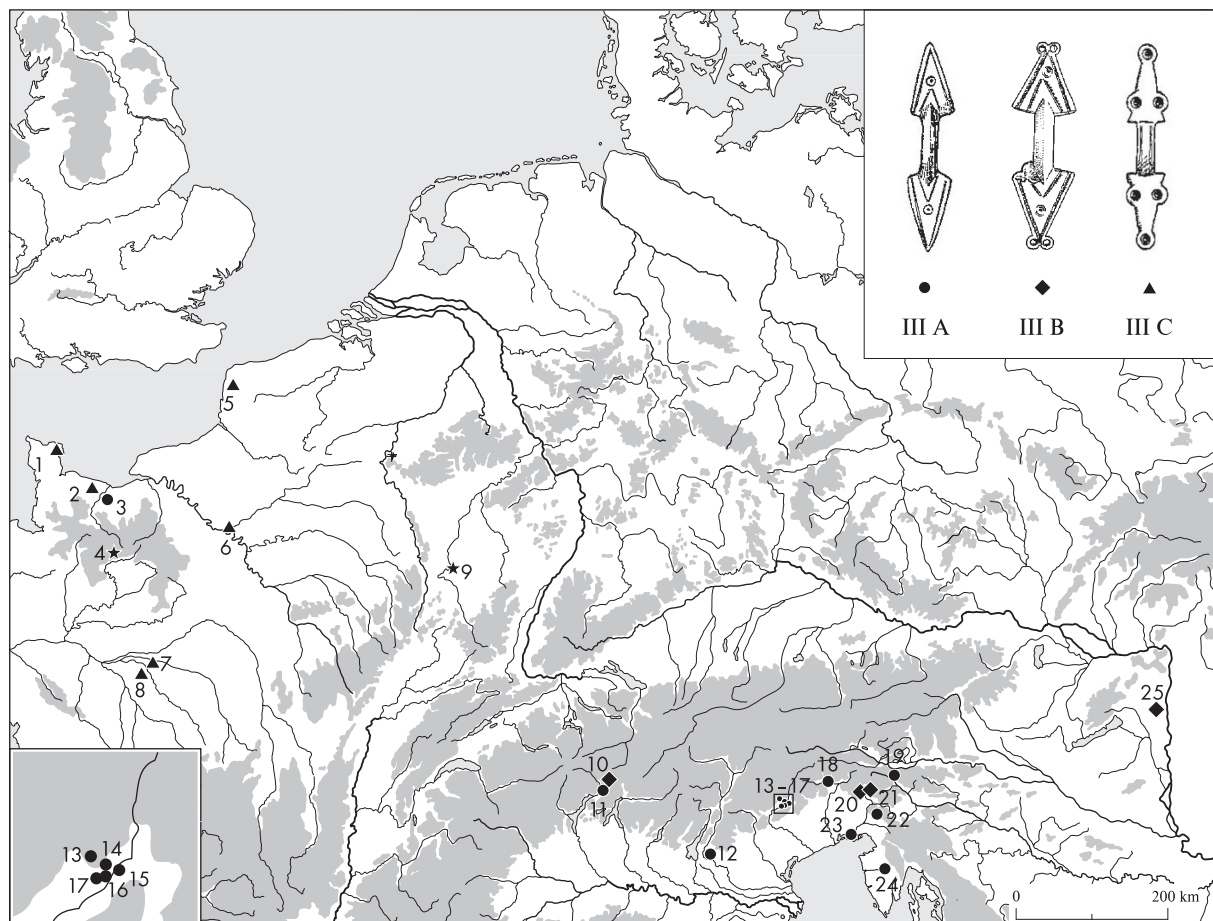

Sl. 2.11: Karta razprostranjenosti dvoramnih fibul (po Thörle 2001, karta 15).

Fig. 2.11: Distribution of equal-arm fibulae (after Thörle 2001, map 15).

7–8) in bronast členek verižice (*t.* 43: 3) so bili najdeni med kamni severnega zidu (SE 121). Železen predmet, ki lahko predstavlja manjše nakovalo (*t.* 43: 6), je bil najden v vkopu faze PA 2 ob zidu SE 122.

V fazi PA 2 je bilo območje stavbe 3 v uporabi kot dvorišče ali delovni prostor. Plast iz tega časa vsebuje številne najdbe. To so bronasta zakovica (*t.* 45: 8), kos bronaste pločevine (*t.* 45: 12), bronast uhan s poliedrom (*t.* 45: 7), del bronaste pločevine z bunčicami (*t.* 45: 11), železna palica z vrezanimi znaki (*t.* 46: 8, domnevno preslica – glej pogl. 2.1.5), bronast predmet (*t.* 45: 13, domnevno kos pasne garniture, pozno 6. st. – prim. Arena et al. 2004, 59: zgoraj levo), bronast prstan z delom napisa AVR (*t.* 45: 5, morda Avrelj) in ročaj ter še en kos ščita (*t.* 46: 9,17). Grba (kalota) ni ohranjena, zato ga težko tipološko in časovno opredelimo, gotovo pa spada med ščite 5.–7. st. (prim. Pirling 1979, t. 9: 1; 24: 4; 58: 2). V isti plasti je bil najden tudi novc Konstansa ali Konstancija II. (348–361, glej pogl. 5, kat. 62).

V to in v spodnjo plast sta bili vkopani dve jami. V prvi so bili najdeni štirje fragmenti rožnega glavnika (*t.* 45: 22), nož in železen predmet (*t.* 46: 7,16), v drugi pa dvoramna fibula (*t.* 45: 2).

During phase LA 2, the area of building 3 was used as a courtyard or a work space. The layer from this time contains numerous finds. These are a bronze rivet (*Pl.* 45: 8), a piece of bronze sheet (*Pl.* 45: 12), a bronze earring with a polyhedron (*Pl.* 45: 7), a piece of bronze sheet with punched decoration (*Pl.* 45: 11), an iron bar with incised symbols (*Pl.* 46: 8, supposedly a distaff – see chapter 2.1.5), a bronze object (*Pl.* 45: 13, supposedly a part of a belt set, late 6<sup>th</sup> century – cf. Arena et al. 2004, 59: top left), a bronze finger ring with part of the inscription AVR (*Pl.* 45: 5, possibly Aurelius), a handle and one other part of a shield (*Pl.* 46: 9,17). A shield boss of this shield is not preserved thus making it difficult to delimit it typologically and in time, nevertheless, it certainly belongs among shields of the 5<sup>th</sup>-7<sup>th</sup> century (cf. Pirling 1979, Pls. 9: 1; 24: 4; 58: 2). The same layer revealed also a coin of Constans or Constantius II (348–361, see chapter 5, cat. no. 62).

Two pits were dug into this layer and the layer below. In the first pit four fragments of an antler comb (*Pl.* 45: 22), a knife, and an iron object (*Pl.* 46: 7,16) were found, and an equal-arm fibula (*Pl.* 45: 2) in the other.

The equal-arm fibula (*Pl.* 45: 2, distribution map Fig. 2.11) can be assigned to the Hübener group 4 (equal-

Dvoramno fibulo (*t. 45: 2, karta sl. 2.11*) lahko uvrstimo v Hübenerjevo skupino 4 (dvoramne fibule s trikotnimi kraki), ki se pojavlja na prostoru jugovzhodnih Alp (Hübener 1972, 217). Nosili naj bi jih predvsem moški. Najnatančnejša analogija tonovski je fibula iz Intercisse (Hübener 1972, sl. 17: 1), zelo podobne pa so ji tudi fibule s Tonovcovemu gradu sosednjega najdišča Gradec pri Logjeh (Osmuk 2001, kat. 131), iz Akvileje (Bierbrauer 1987, t. 61: 2) in Sv. Lovrenca nad Bašljem (Josipovič 1982, 181, sl. 48: 1; Bitenc 2001, kat. 132). Še ena dvoramna fibula s trikotnimi kraki je bila najdena na Lokovcu na Banjšicah (Bitenc 2001, kat. 133; Knific 2002, t. 1: 7).

S. Thörle (2001) je zbral in obdelal evropske dvoramne fibule, ki se v največjem številu pojavljajo na frankovskem ozemlju. Ugotovil je, da se je razvoj dvoramnih fibul najverjetneje začel v jugovzhodnih Alpah, kjer so bili najdeni najstarejši primerki v staroselskih moških grobovih. Skupini III A in B, za kateri so značilni trikotni kraki, okrašeni s krožci s piko ali vrezi, sta bili razprostranjeni v Sloveniji, Italiji in Istri (*sl. 2.11*). V jugovzhodnih Alpah se pojavljajo še dvoramne fibule tipov I A 2 (tip Castel Trosino z zaokroženimi kraki), V A (tip Nocera Umbra s pravokotnimi kraki) in B (tip Voltago s pravokotnimi kraki) ter IX A (posnetki fibul, okrašenih v žilvalskem stilu; Thörle 2001, karte 3, 15, 17, 24). Naštete skupine se pojavljajo na staroselskih najdiščih okvirno v drugi polovici 6. in prvi polovici 7. st. Prevzeli naj bi jih Langobardi, saj so najdene tudi v bogatih moških grobovih v Noceri Umbri in Castel Trosinu. Približno v istem času naj bi se moda dvoramnih fibul, najverjetneje pod langobardskim vplivom, prenesla v frankovsko žensko nošo, kjer se je razvila v mnogo podoblik in se je nadaljevala iz merovinškega obdobja še v karolinško (Thörle 2001, 259–266). Takrat se dvoramne fibule ponovno pojavijo tudi v jugovzhodnoalpskem prostoru, v noši karantanske in ketlaške stopnje.

V ruševini stavbe 2 so ležali žebelji (*t. 44: 4,16–21*), železen okov (*t. 44: 1*), noži (*t. 43: 15,17,19*), kosir (*t. 44: 2*), verjetno zlatarsko orodje (*t. 43: 11*; glej pogl. 2.1.5), kosi svinčene pločevine (*t. 44: 8–9,11–15*), bronasta zakovica (*t. 44: 6*), bronasta žica (*t. 44: 10*), bronasta konica ali igla (*t. 43: 10*), dva železna žeblička za obutev (*t. 44: 5,7*; Bavdek 2005, t. 5: 2; 8: 10; 10: 4), bronast fragment, ki je bil verjetno delček fibule (del loka in držalo za peresovino: *t. 43: 4*) in bronasta trakasta zapestnica (*t. 43: 2*). Bradata sekira brez podaljšanega čela, ki je značilno za sekire poznoantičnega obdobja pri nas (*t. 43: 11*), najbolj spominja na bojne sekire 5. in 6. st. Primerjave ji lahko najdemo predvsem v sekiri iz groba 192 na grobišču Pleidelsheim (Koch 2001, t. 33: D1). Zelo podobne sekire, vendar z nekoliko drugače oblikovanim čelom, so bile najdene tudi na primer na kranjskem grobišču na Lajhu (Knific 1995, sl. 4), na čedajskem grobišču In

arm fibulae with triangle-shaped arms), which appears in the area of the Southeastern Alps (Hübener 1972, 217). It was supposedly worn primarily by men, its most precise analogy is the fibula from Intercissa (Hübener 1972, Fig. 17: 1) and the fibulae from the site Gradec near Logje, which neighbours Tonovcov grad (Osmuk 2001, cat. no. 131), fibulae from Aquileia (Bierbrauer 1987, Pl. 61: 2) and Sv. Lovrenc above Bašelj (Josipovič 1982, 181, Fig. 48: 1; Bitenc 2001, cat. no. 132) are also very similar. Another equal-arm fibula with triangle-shaped arms was found at Lokovec on Banjšice (Bitenc 2001, cat. no. 133; Knific 2002, Pl. 1: 7).

S. Thörle (2001) collected and discussed the European equal-arm fibulae, which appear in greater numbers over the Frankish territory. He discovered that the development of equal-arm fibulae most probably began in the Southeastern Alps, where the oldest examples were found in the Romanized autochthonous male graves. Groups III A and B, for which triangle-shaped arms decorated by ring-and-dots or incisions are characteristic, are distributed over Slovenia, Italy, and Istria (*Fig. 2.11*). In the Southeastern Alps equal-armed fibulae of types I A 2 (type Castel Trosino with rounded arms), V A (type Nocera Umbra with rectangular arms) and B (type Voltago with rectangular arms), and IX A (imitations of fibulae decorated in the animal style; Thörle 2001, distribution maps 3, 15, 17, 24). The above mentioned groups appear at the autochthonous sites approximately in the second half of the 6<sup>th</sup> and in the first half of the 7<sup>th</sup> century. These were supposedly adopted by the Lombards for they were found also in rich male graves at Nocera Umbra and Castel Trosino. Approximately at the same time, the fashion of wearing equal-arm fibulae, most probably under the influence of the Lombards, supposedly transferred onto the Frankish women's attire where it was then developed into numerous subtypes and persists from the Merovingian into the Carolingian period (Thörle 2001, 259–266). At that time the equal-armed fibulae reappear also in the southeastern Alpine territory, in the attire of the Carantanian and Köttlach groups.

In the destruction layer of building 2 nails (*Pl. 44: 4,16–21*), an iron fitting (*Pl. 44: 1*), knives (*Pl. 43: 15,17,19*), a collar ferrule (*Pl. 44: 2*), probably a goldsmith's tool (*Pl. 43: 11*; see chapter 2.1.5), pieces of lead sheet (*Pl. 44: 8–9,11–15*), a bronze rivet (*Pl. 44: 6*), bronze wire (*Pl. 44: 10*), a bronze pin or needle (*t. 43: 10*), two iron nails for sandals (*Pl. 44: 5,7*; Bavdek 2005, Pls. 5: 2; 8: 10; 10: 4), a bronze fragment, probably representing a part of a fibula (a part of the bow and a spring hold: *Pl. 43: 4*), and a bronze band bracelet (*Pl. 43: 2*). A bearded axe head without an extended poll (*Pl. 43: 1*), which is typical of Late Antique axes in Slovenia, resembles most the battle axes of the 5<sup>th</sup> and 6<sup>th</sup> century. Comparisons for it can be found primarily in the axe from grave 192 at the cemetery Pleidelsheim (Koch 2001, Pl. 33: D1). Very similar axes,

Pertica (Ahumada Silva, Lopreato, Tagliaferri 1990, t. XIX: 1) in na grobišču v Rakovčanih (Miletić 1970, t. I: 1; III: 13). Sekira iz ruševine stavbe 2 se najverjetneje povezuje z najdbama delov ščita (*t. 46: 9,17*) severno od stavbe (glej zgoraj). V podobnih okoliščinah, v vrhnjih plasteh še neraziskane stavbe 26 (*sl. 1.1*; glej Tonovcov grad. Naselbinski ostanki in interpretacija, pogl. 1.3) je bila najdena tudi spatha (*t. 11: 10*).

V ruševini je bil najden tudi slabo čitljiv novc s konca 4. in iz prve polovice 5. st. (glej pogl. 5, kat. 155).

V ruševini severno od stavbe 2, to je na območju starejše stavbe 3, so bili najdeni del srebrnega prstana (*t. 45: 6*), tri šivanke (*t. 45: 19–21*), štirje noži (*t. 46: 2–3,5–6*), skoba (*t. 46: 10*), rombična puščična ost s tulom (*t. 45: 18*), dva žeblja (*t. 46: 12,15*), z drobnimi vrezi okrašena železna igla s sploščeno uvito glavo (*t. 45: 10*), bronast trak (*t. 45: 17*), dve železni orodji (*t. 45: 24–25*), nedokončana bronasta sponka ogrlice (*t. 45: 3*) in poškodovan krilat okov poznorimske pasne garniture s podolžnim rebrom (*t. 45: 15*, glej pogl. 2.1.3).

Železna pasna spona (*t. 45: 14*) in železen okov (*t. 43: 9*) sta bila najdena v premešani plasti.

Naključno je bil najden tudi novc Klavdija II. iz leta 270 (glej pogl. 5, kat. 23).

#### GROB 18

Štirje grobovi (št. 15, 18, 19 in 20) so bili vkopani za južni zid (zid 123; *sl. 1.3*) stavbe 2, očitno v času, ko je stavba vsaj v osnovi še stala. Ruševina stavbe jih je namreč popolnoma prekrila, v njej pa ni bilo opaziti nobenega vkopa, ki bi govoril za to, da je bil pokop opravljen, potem, ko je bila stavba že porušena (glej Tonovcov grad. Naselbinski ostanki in interpretacija, pogl. 2.4.2, 3.2).

Samo en grob (št. 18) je imel pridanke. V grobu (moški, *adultus I*, 25–30 let; glej pogl. 7) so bili najdeni nož (*t. 44: 22*) na levi strani medenice, železen jermenski zaključek (*t. 44: 24*) ob medenici in svitkasta zelena jagoda (*t. 44: 23, sl. 2.10: 2*) na levi strani skeleta pod rebri. Kratek razcepljen železen jermenski zaključek z zakovico lahko okvirno datiramo v 8. st. (Kleeman 1992, *sl. 6: Tip 8b*). Jagoda (*t. 44: 23*) spada v čas med koncem 7. in v 8. st. (Dannheimer 1968, 77, t. 1: 57; Pleterski 2008, 64, *sl. 13*).

V zasutju groba je bilo najdenih še nekaj koščkov opeke.

#### SKLEP

Najdbe iz časa pred gradnjo stavbe 3 (1.–3. st.; *t. 43: 5; 45: 1,4,9; 46: 13*) so maloštevilne in neizpovedne, vendar kažejo na obljudenost prostora od 1. st. dalje.

but with a somewhat differently shaped poll, were discovered also at, for example, cemetery Lajh in Kranj (Knific 1995, Fig. 4), at the cemetery In Pertica in Cividale del Friuli (Ahumada Silva, Lopreato, Tagliaferri 1990, Pl. XIX: 1), and at the cemetery in Rakovčani (Miletić 1970, Pls. I: 1; III: 13). The axe from the destruction layer of building 2 is probably connected to the finds of parts of a shield (*Pl. 46: 9,17*) in the courtyard north of the building (see above). A spatha (*Pl. 11: 10*) was found in similar circumstances, in the top layers of the yet unresearched building 26 (*Fig. 1.1*; see Tonovcov grad. Settlement remains and interpretation, chapter 1.3).

A poorly readable coin of the end of the 4<sup>th</sup> and the beginning of the 5<sup>th</sup> century (see chapter 5, cat. no. 155) was also found in the destruction layer.

In the destruction layer north of building 2, i.e. in the area of older building 3, a piece of a silver ring (*Pl. 45: 6*), three sewing needles (*Pl. 45: 19–21*), four knives (*Pl. 46: 2–3,5–6*), a staple (*Pl. 46: 10*), a tanged arrowhead with a rhombic flat head (*Pl. 45: 18*), two nails (*Pl. 46: 12,15*), an iron pin with a flattened rolled head decorated by miniature incisions (*Pl. 45: 10*), a bronze band (*Pl. 45: 17*), two iron tools (*Pl. 45: 24–25*), an unfinished bronze necklace clasp (*Pl. 45: 3*), and a damaged winged fitting of the Late Roman belt set with a longitudinal rib (*Pl. 45: 15*, see chapter 2.1.3) were found.

An iron belt buckle (*Pl. 45: 14*) and an iron fitting (*Pl. 43: 9*) were discovered in a mixed layer.

The coin of Claudius II from 270 (see chapter 5, cat. no. 23) was also a chance find.

#### GRAVE 18

Four graves (nos. 15, 18, 19, and 20) were dug behind the south wall (wall 123; *Fig. 1.3*) of building 2, obviously in a time when the building was still at least partly standing. Namely, the destruction layer of the building covered them completely and there were no pits noticeable which would indicate that they were buried after the building had collapsed (see Tonovcov grad. Settlement remains and interpretation, chapters 2.4.4, 3.2).

Solely one grave (no. 18) included grave goods. A knife (*Pl. 44: 22*) on the left side of the pelvis, an iron strap end (*Pl. 44: 24*) along the pelvis, and a coiled green bead (*Pl. 44: 23, Fig. 2.10: 2*) on the left side of the skeleton, under the ribs, were found in the grave (male, *adultus I*, 25–30 years; see chapter 7). A short split iron strap end with a rivet can be approximately dated to the 8<sup>th</sup> century (Kleeman 1992, Fig. 6: Type 8b). The bead (*Pl. 44: 23*) belongs to a time between the end of the 7<sup>th</sup> and the 8<sup>th</sup> century (Dannheimer 1968, 77, Pl. 1: 57; Pleterski 2008, 64, Fig. 13).

A few pieces of tegulae were discovered in the fill of the grave.

Tudi ostanki iz časa gradnje in delovanja stavbe 3 v fazi PA 1 (druga polovica 4. in začetek 5. st.) niso številni (*t.* 45: 26; 46: 14).

V stavbi 2, ki je bila zgrajena v fazi PA 2 (konec 5.–začetek 7. st.), so bili najdeni poleg nekaj ostankov hišne opreme (tečaj, okovi, žebliji: *t.* 43: 7–8,12,14,16; 44: 3) večinoma delčki bronastih predmetov in koščkov svinca (*t.* 43: 4,10; 44: 6,8–9,11–15). Odkrita sta bila majhno nakovalce (*t.* 43: 6) in orodje (*t.* 43: 11), podobno puncu, ki ga lahko interpretiramo kot zlatarsko orodje, najverjetneje za dodajanje majhnih količin sestavin v prahu (Szameit 1995, 250–251).

V času uporabe stavbe 2 je bilo območje stavbe 3 dvorišče oziroma gospodarski prostor. Tu je bilo najdenih še več sledov, ki kažejo na predelavo ali izdelavo majhnih nakitnih bronastih in srebrnih predmetov: orodje (punca?; *t.* 45: 24), kosi srebrnega in bronastih prstanov, uhan, kos poznega pasnega okova, okrašena železna iglica, koščki bronaste in svinčene pločevine, nedokončana sponka za ogrlico in košček bronaste pločevine z zakovico za popravila (*t.* 45: 3,5–8,10,12–13,15,17,19–21,25). Predmetov, ki bi jih lahko povezovali z drugimi dejavnostmi, skoraj ni bilo. Edine izjeme so tri šivanke različnih velikosti (*t.* 45: 19–21) ter domnevna preslica (*t.* 46: 8). Morda lahko stavbo 2 in dvorišče v fazi PA 2 (konec 5.–začetek 7. st.) interpretiramo kot popravljalnico oz. predelovalnico majhnih nakitnih predmetov, morda celo zlatarsko delavnico. To interpretacijo podpirata tudi siceršnje majhno število najdb v stavbi 2 ter odsotnost ognjišča, ki bi bilo potrebno v bivalni hiši (za drugo mogočo interpretacijo glej Tonovcov grad. Naselbinski ostanki in interpretacija, pogl. 4.2.6).

Orodje za predelavo kovin morda lahko razloži tudi veliko količino drobnih predmetov iz stavbe 1, ki so mnogo starejši od plasti, v katerih so ležali (glej pogl. 2.1.1). Ti predmeti so bili morda zbirani za predelavo.

Dva dela ščita (*t.* 46: 9,17) iz ruševine in sekira (*t.* 43: 1) lahko nakazujejo dogajanje ob propadu ali morebitnem nasilnem koncu naselbine.

Ko je bila stavba 2 opuščena, so bili za njen južni zid (zid 123) vkopani štirje grobovi (št. 15, 18, 19 in 20). Grob 18, ki je edini imel pridatke, je datiran v konec 7. in 8. st.

### 2.3 SKLOP CERKVA, VMESNI PROSTOR IN GROBOVI

Na skalnem platoju na južnem delu naselbine je bil v drugi poznoantični fazi (PA 2; konec 5.–začetek 7. st.) postavljen sklop treh cerkva (severna, osrednja in južna) z "memorijo" in v skalo vklesanim vmesnim prostorom.

Nekaj drobnih najdb je bilo odkritih v sondah, ki so bile narejene pod estrihi v severni in osrednji cerkvi, in

### CONCLUSION

Finds from the time before the construction of building 3 (1<sup>st</sup>-3<sup>rd</sup> century; *Pls.* 43: 5; 45: 1,4,9; 46: 13) are scarce and unrevealing, yet they point to the inhabiting of the area from the 1<sup>st</sup> century onwards.

The remains from the time of the construction and functioning of building 3 in phase LA 1 (the second half of the 4<sup>th</sup> and the beginning of the 5<sup>th</sup> century) are also not many (*Pls.* 45: 26; 46: 14).

Building 2, which was built in phase LA 2 (end of the 5<sup>th</sup>-beginning of the 7<sup>th</sup> century), revealed besides a few remains of architectural fittings (hinges, fittings, nails: *Pls.* 43: 7-8,12,14,16; 44: 3) mostly pieces of bronze objects and pieces of lead (*Pls.* 43: 4,10; 44: 6,8-9,11-15). A small anvil (*Pl.* 43: 6) and a tool (*Pl.* 43: 11) similar to a punch which can be interpreted as a goldsmith's tool, probably used to add small amounts of powdered ingredients (Szameit 1995, 250-251), were also discovered here.

During the time when building 2 was functional, the area of building 3 represented its courtyard or a work space. Here several other traces indicating the processing and manufacturing of small jewellery bronze and silver objects were found: a tool (a punch?; *Pl.* 45: 24), pieces of silver and bronze finger rings, earrings, a piece of a Late Roman belt fitting, a small decorated iron pin, pieces of bronze and lead sheet, an unfinished necklace clasp, and a piece of bronze sheet with a rivet for mending (*Pl.* 45: 3,5-8,10,12-13,15,17,19-21,25). Objects that could be connected to other activities were practically non-existent. The only exceptions are the three needles of various sizes (*Pl.* 45: 19-21) and a supposed distaff (*Pl.* 46: 8). Maybe building 2 and the courtyard in phase LA 2 (end of the 5<sup>th</sup> - beginning of the 7<sup>th</sup> century) can be interpreted as a repair shop or a processing shop for small jewellery objects, possibly even a goldsmith's shop. This interpretation is supported by the generally small number of finds in building 2 and the lack of a fire-place which would be necessary in a house (for the other possible interpretation see Tonovcov grad. Settlement remains and interpretation, chapter 4.2.6).

Metal production tools can possibly also explain the large number of small objects from building 1, which are much older than the layer in which they were found (see chapter 2.1.1). These objects could have been chosen for processing.

Two parts of a shield (*Pl.* 46: 9,17) from the destruction layer and an axe (*Pl.* 43: 1) could indicate the events upon the downfall or possible violent end of the settlement.

Not long after building 2 was abandoned, four graves (nos. 15, 18, 19, and 20) were dug behind its southern wall (wall 123). Grave 18, which was the only one that included grave goods, is dated to the end of the 7<sup>th</sup> and the 8<sup>th</sup> century.

so iz časa pred izgradnjo sklopa. Velika večina predmetov je ležala v ruševinskih plasteh na hodnih površinah cerkvenih stavb in spadajo v fazo PA 2.

Posamezne najdbe in grob 21, vkopan v ruševinske plasti v vmesnem prostoru med osrednjo in južno cerkvijo, so iz zgodnjerednjeveškega obdobja (glej Tonovcov grad. Naselbinski ostanki in interpretacija, pogl. 2.5).

### 2.3.1 SEVERNA CERKEV

V ruševinski plasti so bili najdeni velik žebelj (*t. 47: 9*), del žeblija (*t. 47: 7*), bronast trakast prstan z zakovico (*t. 47: 1*), železen obroček (*t. 47: 5*), del noža (*t. 47: 2*) in puščična ost z rombično ploščato konico in trnom (*t. 47: 4*). Prstan z zakovico je podoben prstanu iz groba 21 (*t. 53: 11*; glej pogl. 2.3.7), ki je okvirno datiran v 8. st.

V ladji pod estrihom sta bila najdena železen nož (*t. 47: 6*) in železna konica (*t. 47: 8*).

V narteksu severne in osrednje cerkve v plasti pod hodno površino je ležal kos bronaste žice (*t. 47: 3*), ki bi lahko bil del sistema za obešanje steklenih svetilk (prim. Chevalier 1999, sl. 11).

### 2.3.2 OSREDNJA CERKEV

V ruševinskih plasteh so bili najdeni veliki žebliji (*t. 48: 1,3-12; 49: 1-4*), manjši žebelj (*t. 47: 14*), okov v obliki okrogle plošče z luknjo (*t. 47: 17*), majhno šilo (*t. 47: 15*), nekaj železnih žičk (*t. 47: 13,16*) in železen nož (*t. 48: 2*).

V plasti odpadlega ometa sta ležala preluknjana košček keramike s prilegajočim se koščkom svinca (*t. 47: 10,11*) in v obliko črke S zvit svinčen trak (*t. 47: 12*).

V notranjosti cerkve pod estrihom so bili najdeni železen predmet (*t. 49: 5*) in nekaj črepinj okenskega stekla.

### 2.3.3 "MEMORIJA"

V ruševinski plasti so ležali velik žebelj (*t. 51: 1*), majhen žebelj (*t. 51: 2*) neokrašen bronast obroček (*t. 51: 3*) in novc Proba (276-282, glej pogl. 5, kat. 26).

V kulturni plasti je bil najden Arkadijev novc (388-403, glej pogl. 5, kat. 89).

### 2.3.4 JUŽNA CERKEV

V ruševinski plasti so bili najdeni puščična ost s trikotno ploščato konico in tulom (*t. 49: 9*), puščična ost z rombično ploščato konico in trnom (*t. 49: 10*), žebliji (*t. 49: 11,13,14*), železna konica (*t. 49: 12*), velik žebelj

## 2.3 ECCLESIASTICAL COMPLEX, AREA BETWEEN THE CHURCHES AND GRAVES

An ecclesiastical complex of three churches (north, main, and south) with a 'memoria' and an area cut into the rock in between them was built on the rocky plateau in the southern part of the settlement during the second Late Antiquity phase (LA 2; end of the 5<sup>th</sup> - beginning of the 7<sup>th</sup> century).

A few small finds were discovered in trial trenches, dug under the mortar floors in the north and main church, which belong to the time before the complex was built. The great majority of items were lying in the destruction layers on the walking surfaces of ecclesiastical buildings and belong to phase LA 2.

Individual finds and grave 21, dug into the destruction layers at the area between the main and south church, belong to the Early Medieval period (see Tonovcov grad. Settlement remains and interpretation, chapter 2.5).

### 2.3.1 NORTH CHURCH

A big nail (*Pl. 47: 9*), a part of a nail (*Pl. 47: 7*), a bronze sheet ring with a rivet (*Pl. 47: 1*), an iron ring (*Pl. 47: 5*), a part of a knife (*Pl. 47: 2*), and a tanged arrowhead with a rhombic flat head (*Pl. 47: 4*) were found in the destruction layer. The ring with a rivet is similar to the ring from grave 21 (*Pl. 53: 11*; see chapter 2.3.7), which is approximately dated to the 8<sup>th</sup> century.

In the nave, beneath the mortar floor an iron knife (*Pl. 47: 6*) and an iron point (*Pl. 47: 8*) were found.

In the narthex of the north and main church, in the layer beneath the walking surface a piece of bronze wire (*Pl. 47: 3*) that could belong to the system for hanging glass lamps (cf. Chevalier 1999, Fig. 11) was found.

### 2.3.2 MAIN CHURCH

In the destruction layers big nails (*Pls. 48: 1,3-12; 49: 1-4*), a smaller nail (*Pl. 47: 14*), a fitting shaped as a round plate with a hole (*Pl. 47: 17*), a small awl (*Pl. 47: 15*), several iron wires (*Pl. 47: 13,16*), an iron knife (*Pl. 48: 2*) were found.

In the layer of fallen-off plaster a perforated piece of pottery with a fitting piece of lead (*Pl. 47: 10-11*) and an S-shaped lead strap (*Pl. 47: 12*) were lying.

Inside the church, beneath the mortar floor an iron object (*Pl. 49: 5*) and a few shards of window glass were found.

(*t. 49: 15*), neokrašen bronast obroček (*t. 49: 17*) in kos bronaste pločevine (*t. 49: 16*).

V nartekstu južne cerkve je bil pred izkopavanji najden velik kos bronaste pločevine (*t. 50: 1*; detektorska najdba), del kotla s trikotnimi držaji za ročaj. Luknje v pločevini govorijo o tem, da je bil popravljan s krpami brona in zakovicami (dve sta ohranjeni). Kotel podobne oblike je bil najden v moškem grobu 204 na grobišču Gimnazija v Várpaloti, skupaj z bizantinsko pasno spono, datiran pa je v 6.–7. st. (Garam 2001, 173–174).

### 2.3.5 ZUNAJ CERKVA

Zunaj stavb v ruševini sta bila najdena še kos bronaste pločevine (*t. 49: 7*) in žebelj (*t. 49: 8*).

### 2.3.6 VMESNI PROSTOR MED OSREDNJO IN JUŽNO CERKVIJO

Na skalnatem prostoru med osrednjo in južno cerkvijo, katerega funkcije ne moremo dokončno pojasniti, se izmenjujejo plasti grušča, malte in ruševin, ki jih povezujemo s cerkvami in čas njihovega obstoja postavljamo v fazo PA 2 med koncem 5. in začetkom 7. st. (glej Tonovcov grad. Naselbinski ostanki in interpretacija, pogl. 3.3.3). V teh plasteh je bilo odkritih malo drobnih najdb, ki ne pripomorejo veliko k interpretaciji, ter novec Konstansa (348–350, glej pogl. 5, kat. 45).

Železna obročasta fibula z navznoter zavrtimi konci (*t. 52: 1*) je bila najdena v ruševini. Tovrstne fibule so značilne predvsem za 3. in 4. st. (glej pogl. 2.1.1).

Bronast prstan z rumenim kamnom ali steklom (*t. 52: 4*) je bil najden v maltni plasti skupaj z majhnim žebličkom (*t. 52: 11*). Obroč ima izdelan iz bronaste pločevine, okrašen z dvema zareza. Celica je prav tako izdelana iz dvojnega traku pločevine, vanjo je vloženo rumeno steklo ali okrasni kamen. Podoben prstan je bil najden v grobu 358 iz druge polovice 6. st. na blejski Pristavi (Knific 2004, sl. 8: 9). Celica za okrasni kamen spominja na celice na ploščatih križnih fibulah z okrasnim kamnom ali na košarice uhanov s košarico (prim. Knific 2001, kat. 142, 123), kar je lahko poleg stratigrafske lege argument za to, da ga časovno uvrstimo v 6. st.

Dve jagodi, majhna cevasta rdeča (*t. 52: 3, sl. 2.12: 2*) in modra štiridelna z rdečo valovnico (*t. 52: 2, sl. 2.12: 1*), sta bili najdeni v grušču. Štiridelni jagodi nam ni uspelo najti primerjav. Po mnenju A. Pleterskega sta jagodi glede na material in izdelavo lokalna proizvodna zgodnjeresrednjeveškega obdobja in bi ju lahko uvrstili v 7. ali 8. st.<sup>9</sup>

<sup>9</sup> Ustna informacija. Za pomoč pri opredelitvi se najlepše zahvaljujem A. Pleterskemu.

### 2.3.3 'MEMORIA'

A big nail (*Pl. 51: 1*), a small nail (*Pl. 51: 2*), an undecorated bronze ring (*Pl. 51: 3*), and a coin of Probus (276–282, see chapter 5, cat. no. 26) were found in the destruction layer.

A coin of Arcadius (388–403, see chapter 5, cat. no. 89) was found in the cultural layer.

### 2.3.4 SOUTH CHURCH

A socketed arrowhead with a triangular flat head (*Pl. 49: 9*), a tanged arrowhead with a rhombic flat head (*Pl. 49: 10*), nails (*Pl. 49: 11,13–14*), an iron point (*Pl. 49: 12*), a big nail (*Pl. 49: 15*), an undecorated bronze ring (*Pl. 49: 17*), and a piece of bronze sheet (*Pl. 49: 16*) were found in the destruction layer.

In the narthex of the south church, a big piece of bronze sheet (*Pl. 50: 1*; found by metal detector) was found prior to the excavations and was once part of a cauldron with triangular grips for the handle. The holes in the sheet testify to the fact that it was mended by patches of bronze and rivets (two are preserved). The cauldron of a similar shape was found in male grave 204 at the cemetery Várpalota-High school, along with a Byzantine belt buckle, and is dated to the 6<sup>th</sup>–7<sup>th</sup> century (Garam 2001, 173–174).

### 2.3.5 OUTSIDE OF CHURCHES

Outside of the churches, in the destruction layer a piece of bronze sheet (*Pl. 49: 7*) and a nail (*Pl. 49: 8*) were discovered.

### 2.3.6 SPACE BETWEEN MAIN AND SOUTH CHURCH

In the rocky space between the main and south church, the function of which cannot be definitely explained, layers of gravel, mortar, and ruins exchange. All are connected to churches and are dated to the time of their existence in phase LA 2, between the end of the 5<sup>th</sup> and the beginning of the 7<sup>th</sup> century (see Tonovcov grad. Settlement remains and interpretation, chapter 3.3.3). These layers have yielded few small finds, which do not contribute significantly to the interpretation, and a coin of Constans (348–350, see chapter 5, cat. no. 45).

An iron Roman penannular fibula with rolled ends (*Pl. 52: 1*) was found in the destruction layer. Such fibulae are characteristic mostly of the 3<sup>rd</sup> and 4<sup>th</sup> century (see chapter 2.1.1).

A bronze ring with a yellow stone or glass (*Pl. 52: 4*) was found in the mortar layer along with a small

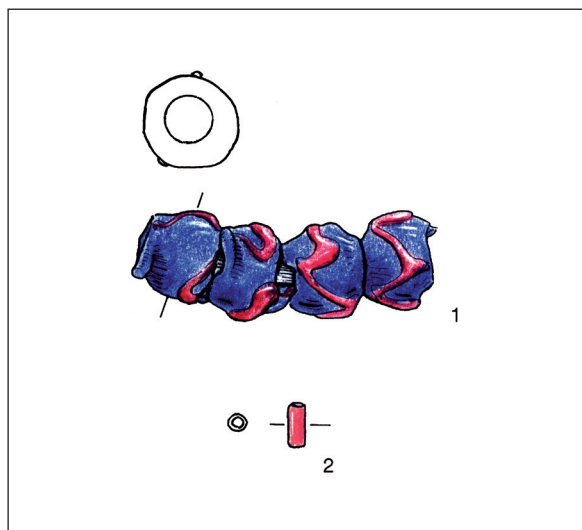

Sl. 2.12: Jagodi iz gruščnatih plasti iz prostora med osrednjo in južno cerkvijo (t. 52: 2–3). Steklo. M. = 1:1.

Fig. 2.12: Beads from gravel layers in the area between the main and the south church (Pl. 52: 2-3). Glass. Scale = 1:1.

V različnih plasteh so ležali še štirje odlomki bronca (t. 52: 5–6,8,12), železna noža (t. 52: 10,17), železen predmet (t. 52: 14), okrogel prodnik (t. 52: 20), žebliček (t. 52: 11), železen predmet (t. 52: 15), noga močno profilirane bronaste fibule (t. 52: 7), žebliji (t. 52: 16,18; 53: 6–9), železna konica (t. 52: 19), trije svinčeni predmeti (t. 53: 1,3,4), pol bronastega prstana (t. 52: 9) in svinčeni ingot ali utež (masa = 66,80 g; t. 53: 2).

Glede na obliko železnega predmeta in svinčenih (t. 52: 15; 53: 1,3–4) bi morda lahko sklepali, da gre za dele manjših svečnikov. Železen predmet ima dve konici, z eno je bil lahko pritrjen na podlago, na drugo pa bi lahko pritrjili svečo. Svinčeni zvitki so oblikovani podobno kot tridelne rozete na svečnikih iz Rogoznice pri Ptuj (Knific, Sagadin 1991, 48, kat. 1–2).

### 2.3.7 GROBOVI

Odlomljen ročaj ključa(?) (t. 49: 6) je ležal v zasutju groba 2, ki je bil sicer brez pridatkov (glej Tonovcov grad. Naselbinski ostanki in interpretacija, pogl. 2.5).

#### GROB 3

Grob 3 (ženska, matusus, 40–60 let, glej pogl. 7.2) je bil najden ob zunanji steni narteksa južne cerkve (Tonovcov grad. Naselbinski ostanki in interpretacija, sl. 2.76). V njem so bili poleg okostja par preprostih bronastih žičnatih uhanov (t. 51: 4,5) ob glavi, ogrlica iz steklenih jagod (t. 51: 7, sl. 2.13) okrog vratu in srebrn prstan (t. 51: 6, sl. 2.14).

nail (Pl. 52: 11). The band of the ring is made of bronze sheet and is decorated by two incisions. The cell is also made of double sheet strap with yellow glass or a decorative stone embedded in it. A similar ring was found in grave 358 from the second half of the 6<sup>th</sup> century at Pristava in Bled (Knific 2004, Fig. 8: 9). The cell for the decorative stone resembles the cells on cross-shaped fibulae with a gemstone or baskets of basket earrings (cf. Knific 2001, cat. nos. 142, 123), which can be, besides the stratigraphic position, an additional argument for the dating into the 6<sup>th</sup> century.

Two beads, a small tubular red one (Pl. 52: 3, Fig. 2.12: 2) and a blue four-partite one with a red wavy line (Pl. 52: 2, Fig. 2.12: 1) were found in the gravel. We failed to find analogies for the four-partite bead. According to A. Pleterski the beads are, considering the material and the manufacturing, local products of the Early Medieval period and could be assigned to the 7<sup>th</sup> or 8<sup>th</sup> century.<sup>9</sup>

In various layers we found four fragments of bronze (Pl. 52: 5-6,8,12), two iron knives (Pl. 52: 10,17), an iron object (Pl. 52: 14), a round pebble (Pl. 52: 20), a nail (Pl. 52: 11), an iron object (Pl. 52: 15), a foot of a strongly profiled bronze fibula (Pl. 52: 7), nails (Pls. 52: 16,18; 53: 6-9), an iron point (Pl. 52: 19), three lead objects (Pl. 53: 1,3-4), one half of a bronze ring (Pl. 52: 9), and a lead ingot or weight (66.80 g; Pl. 53: 2).

Considering the shape of the iron and lead objects (Pls. 52: 15; 53: 1,3-4) we could presume that these are parts of small candlesticks. The iron object has two tips, one could be attached to the base while the other could hold a candle. The lead rolls are shaped similarly to three-part rosettes on candlesticks from Rogoznica near Ptuj (Knific, Sagadin 1991, 48, cat. nos. 1-2).

### 2.3.7 GRAVES

A broken-off key (?) handle (Pl. 49: 6) was lying in the fill of grave 2 which was otherwise without grave goods (see Tonovcov grad. Settlement remains and interpretation, chapter 2.5).

#### GRAVE 3

Grave 3 (female, matusus, 40–60 years, see chapter 7.2) was found along the outer wall of the south church narthex (Tonovcov grad. Settlement remains and interpretation, Fig. 2.76). A pair of simple bronze wire earrings (Pl. 51: 45) was found along the head, a necklace made of glass beads (Pl. 51: 7, Fig. 2.13) around the neck, and a silver ring (Pl. 51: 6, Fig. 2.14).

Small blue and green ring-shaped and tubular glass beads (Pl. 51: 7b-k,m,o-p) appear in Antiquity

<sup>9</sup> Personal comment. I sincerely thank A. Pleterski for his help with the classification.

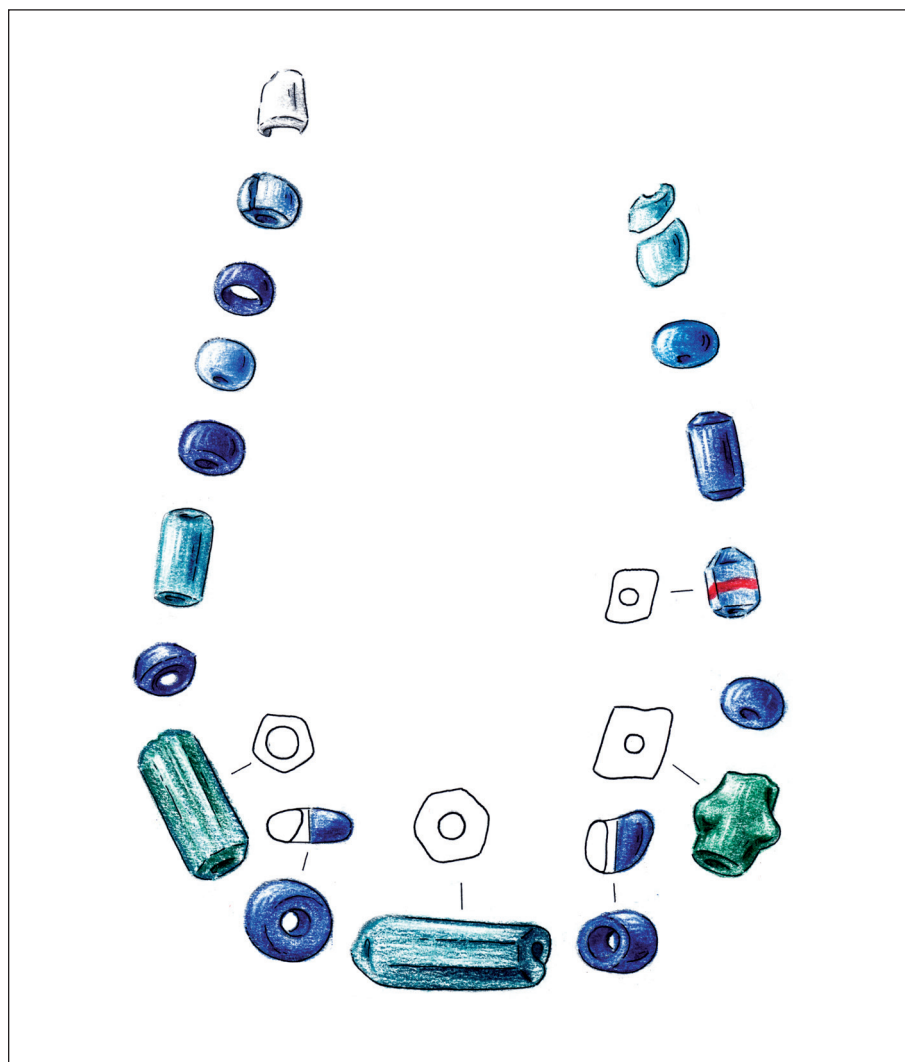

Sl. 2.13: Ogrlica iz steklenih jagode iz groba 3 (t. 51: 7). Steklo. M. = 2:1.  
 Fig. 2.13: Glass bead necklace from grave 3 (Pl. 51: 7). Glass. Scale = 2:1.

Majhne modre in zelene obročaste in cevaste steklene jagode (t. 51: 7b–k,m,o–p) se pojavljajo v antiki (Templemann-Mączyńska 1985, 31–53) in v zgodnjem srednjem veku (prim. Dannheimer 1968, t. 1, 2). Zdi se, da so v grobu 3 zastopane tudi jagode iz t. i. pramenastega stekla. Zanj je značilno, da je steklo narejeno z rastlinskim pepelom, ne z natronom, ter zato manj kvalitnetno. Tako neenakomerno razpada in dobi na površini pramenasto strukturo. Takšno steklo se prvič pojavljati po začetku 7. st., natančen čas pojava in širitve pa še ni znan (Uboldi, Verità 2003, 130–131). Kemijske analize tonovskih jagode niso bile narejene, tako da tega ne moremo potrditi ali ovreči.

Par bronastih žičnatih uhanov (t. 51: 4–5) spada med izredno pogoste in dolgo uporabljane oblike antičnega in tudi zgodnjersrednjeveškega nakita in ga ne moremo natančno časovno opredeliti. Verjetno je, da sta uhana imela nekoč pripete obeske, ki pa se niso ohranili.

(Templemann-Mączyńska 1985, 31–53) as well as in Early Middle Ages (cf. Dannheimer 1968, Pls. 1, 2). It seems that in grave 3 also beads made of the so called 'furrowed' glass appear. This is glass made with plant ash, not natron, and therefore of lesser quality. It decays unevenly so the surface appears furrowed. Such glass appears after the beginning of the 7<sup>th</sup> century, but it is not yet known exactly when and where (Uboldi, Verità 2003, 130–131). Chemical analyses of beads from grave 3 were not conducted so final conclusions cannot be made.

A pair of bronze wire earrings (Pl. 51: 4–5) belong among the extremely frequent and long used forms of Antique and also Early Medieval jewellery and cannot be precisely dated. It is probable that the earrings had pendants which are not preserved.

A big silver ring (Pl. 51: 6, Fig. 2.14) with two pellets and a scaly ornament on each side of the stone is quite worn and partly damaged. A chipped piece of



Velik srebrn prstan (*t. 51: 6, sl. 2.14*) s po dvema kroglicama in luskastim okrasom na vsaki strani kamna je precej obrabljen in delno poškodovan, vložen ima okrušen košček svetlo turkiznega stekla, ki je najverjetneje zamenjal prvotni okrasni kamen. Prstan je bil glede na obrabljenost verjetno kar nekaj časa v rabi. Po osnovni obliki spada v precej razširjen, tako imenovan sirijski tip, ki se je nosil v 3. in 4. stoletju (Henig 1978, 37; Guiraud 1989, 188; Riha 1990, 32). Sirijski tip prstanov je v nekoliko masivnejši obliki ponovno zaživel v bizantinskem zlatarstvu. Najboljše primerjave tonovškemu prstanu najdemo v langobardskem moškem grobu 1 na grobišču San Martino v Trezzo d'Adda, kjer je bil najden zlat prstan s štirimi kroglicami na obroču in vstavljeno starejšo rimsko gemo. Grobna celota je datirana v začetek 7. st. (De Marchi 2000, 169). Prav tako primerljiv je zlat prstan z modro gemo iz ženskega groba 168 iz Sabione, datiran v prvo tretjino 7. st. (Ciurletti 1997, 524, sl. 151). Prstan s Tonovcovega gradu bi lahko izviral iz bizantinskih delavnic.

Glede na jagode in prstan ter lego ob najmlajšem delu cerkvenega kompleksa lahko grob 3 postavimo v začetek 7. st. ali še nekoliko pozneje.

#### GROB 21

Na severnem delu vmesnega prostora med osrednjo in južno cerkvijo je bil odkrit grob 21 (*sl. 1.5*; ženska, adultus II, 30–40 let, glej pogl. 7.2), vkopan v ruševinsko plast. V njem so bili najdeni železen nož (*t. 53: 12*) ob levi nadlakti, trakast bronast prstan z zakovico (*t. 53: 11*) na desni roki, bronasta fibula (*t. 53: 10*) s čebuličastimi gumbi tipa Keller 1a v desni roki in bronasta uhana z obešenima steklenima jagodama v ustih. Fibule tipa Keller 1a so datirane približno med 280–320 (Pröttel 1988, 349–353).

Prstani z zakovico so značilni predmeti zgodnje-srednjeveške karantanske in ketlaške skupine jugovzhodnoalpskega območja, v antičnem obdobju pa se ne pojavljajo. Tako lahko grob glede na prstan postavimo najprej v 8. st. (Knific 2004, sl. 12: 14; 14: 6; 15: 15).



light turquoise glass is inserted where the original ornamental stone used to be. The ring was, considering the condition, probably used for a long time. According to the basic form it belongs among the quite frequent, so-called Syrian type, which was worn in the 3<sup>rd</sup> and 4<sup>th</sup> century (Henig 1978, 37; Guiraud 1989, 188; Riha 1990, 32). The Syrian type of rings was in a somewhat more massive form revived in the Byzantine jewellery. The best comparisons for the ring from Tonovcov grad can be found in Lombard male grave 1 at the cemetery San Martino in Trezzo d'Adda: a gold ring with four pellets on the ring and an inserted older Roman gemstone. The grave group is dated to the beginning of the 7<sup>th</sup> century (De Marchi 2000, 169). Also comparable is a gold ring with a blue gemstone from female grave 168 from Sabiona, dated to the first third of the 7<sup>th</sup> century (Ciurletti 1997, 524, Fig. 151). The ring from Tonovcov grad could originate in the Byzantine workshops.

Considering the beads and the ring as well as the position along the youngest part of the ecclesiastical complex grave 3 can be assigned to the beginning of the 7<sup>th</sup> century or a little later.

#### GRAVE 21

At the northern part of the space between the main and the south church grave 21 (*Fig. 1.5*; female, adultus II, 30–40 years, see chapter 7.2) was discovered. It was dug into the destruction layer. It contained an iron knife (*Pl. 53: 12*) along the left upper arm, a bronze sheet ring with a rivet (*Pl. 53: 11*) on the right hand, a bronze cross-bow fibula (*Pl. 53: 10*) of type Keller 1a in the right hand, and two bronze earrings with hanging glass beads in the mouth. Fibulae of type Keller 1a are dated approximately between 280 and 320 (Pröttel 1988, 349–353).

Rings with rivets are characteristic objects of the Early Medieval Carantanian and Kottlach groups of the Southeastern Alps and do not appear in the Antique period. Thus the grave can, according to the ring, be assigned to the 8<sup>th</sup> century at the earliest (Knific 2004, Figs. 12: 14; 14: 6; 15: 15).

Immediately above the grave a piece of an East Mediterranean amphora was found (*Pl. 101: 6*). The grave fill revealed three glass fragments, two rims and a base (*Pl. 61: 14–16*), and a piece of lead (*Pl. 52: 13*).

*Sl. 2.14: Prstan iz groba 3 (t. 51: 6; foto: M. Zaplatil).*

*Fig. 2.14: Finger ring from grave 3 (Pl. 51: 6; photo: M. Zaplatil).*

Tik nad grobom je ležal kos vzhodnosredozemske amfore (*t. 101: 6*, glej pogl. 4.1.7). V zasutju groba so bili najdeni trije stekleni odlomki, dve ustji in dno (*t. 61: 14–16*) in kos svinca (*t. 52: 13*).

### 2.3.8 SKLEP

V cerkvenem kompleksu, ki je datiran v drugo poznoantično fazo (konec 5. do začetka 7. st.; PA 2), je bilo z izjemo stekla (glej pogl. 3.3) najdenih malo drobnih najdb. V prezbitteriju in ladji osrednje cerkve je med ostanki strešne opeke ležalo večje število velikih žebeljev (*t. 48; 49: 1–4, sl. 3.2*). Veliki žebli so najverjetneje pripadali lesenim konstrukcijam v notranjosti cerkve, morda oltarni pregradi, ciboriju ali celo strehi. Podobna situacija, žganina z veliko dolgimi žebli na estrihu, je znana iz četrte cerkve zahodnega sklopa na Sv. Hemi, kjer so žebli interpretirali kot del strešne konstrukcije (Ladstätter 2000, 197, t. 59). Nekaj velikih žebeljev je bilo najdenih tudi v zgornji cerkvi na Kučarju (Ciglenečki 1995, t. 78: 2–4).

Ostanki železnih žic (*t. 47: 16*) iz osrednje cerkve bi lahko bili del sistema obešanja visečih svetilk, vendar je to le predlog interpretacije (prim. Chevalier 1999, sl. 11).

V drugih dveh cerkvah in "memoriji" je bilo najdb bistveno manj. Omenimo lahko le nekaj delov opreme cerkvenih zgradb v ruševinah (žebli: *t. 52: 16; 53: 7–9*, morda deli svečnikov: *t. 52: 15; 53: 1–4*) in prstan z rumenim steklenim vložkom, ki je bil najden v maltni plasti (*t. 52: 4*).

Zanimivi sta tudi stekleni jagodi (*t. 52: 2–3*), ki najverjetneje kažeta pozen čas uporabe prostora, ko cerkve niso več služile svojemu namenu, niso pa še bile očitno popolnoma porušene.

Ostankov kamnite cerkvene opreme ni bilo, niti barvanega ometa ali celo fresk. Le nad prehodom iz prezbitterija osrednje cerkve v "memorijo" je bil verjetno vzdian lepo izdelan arhitrav (glej Tonovcov grad. Naselbinski ostanki in interpretacija, pogl. 2.5.2). Ni jasno, ali so bile cerkve v osnovi tako preprosto opremljene ali pa so bile naknadno izpraznjene.

Drobnih najdb v vmesnem prostoru ni mogoče natančno časovno opredeliti, ker gre večinoma za majhne in težko opredeljive odlomke s širokim časovnim razponom uporabe.

Najverjetneje ob koncu 7. ali na začetku 8. st., torej stoletje po propadu cerkva, je bil v ruševinske plasti dvorišča vkopan tudi ženski grob 21 (*t. 53: 10–12*) s časovno zelo raznolikimi pridatki. To kaže, da je za nekatere ljudi prostor bivšega cerkvenega kompleksa obdržal poseben pomen in so tam pokopavali svoje mrtve še po opustitvi same naselbine. Na kasnejše obiske prostora kaže tudi v ruševini najden zgodnesrednjeveški prstan z zakovico (*t. 47: 1*), ki spada v isti čas kot grob 21.

### 2.3.8 CONCLUSION

In the ecclesiastical complex dated to the second Late Antiquity phase (end of the 5<sup>th</sup> to the beginning of the 7<sup>th</sup> century; LA 2) with the exception of glass (see chapter 3.3) very few small finds were discovered. In the presbytery and nave of the main church a larger number of big nails (*Pls. 48; 49: 1–4, Fig. 3.2*) was found among the remains of the tegulae. Big nails were probably part of a wooden construction within the church, possibly an altar partition wall, ciborium or even roof. A similar situation, burnt remains with many long nails on the mortar floor, is known from the fourth church of the western complex at Hemmaberg, where the nails are interpreted as part of the roof construction (Ladstätter 2000, 197, Pl. 59). A few big nails were found also in the upper church at Kučar (Ciglenečki 1995, Pl. 78: 2–4).

Remains of iron wires (*Pl. 47: 16*) from the main church could represent parts of systems for hanging lamps but this is only a suggested interpretation (cf. Chevalier 1999, Fig. 11).

The other two churches and the memoria revealed significantly less finds. We should only mention a few parts of the church equipment in the ruined buildings (nails: *Pls. 52: 16; 53: 7–9*, possibly parts of candlesticks: *Pls. 52: 15; 53: 1–4*), and a ring with a yellow glass insert found in a mortar layer (*Pl. 52: 4*).

Two glass beads (*Pl. 52: 2–3*) are also interesting and most probably indicate the late use of this space, when the churches were no longer in use but the buildings had not yet completely collapsed.

There were no remains of architectural sculpture, neither were there any coloured plaster or frescos. Only above the passage from the presbytery of the main church into 'memoria' a beautifully made architrave was probably immured (see Tonovcov grad. Settlement remains and interpretation, chapter 2.5.2). It is not clear whether the churches were originally as simply furnished or they were subsequently emptied.

Small finds in the space between churches are not well datable since they are mostly represented by small and difficult to delimit fragments with a wide time range in use.

A century after the abandonment of the churches, most probably at the end of the 7<sup>th</sup> and beginning of the 8<sup>th</sup> century a female grave 21 (*Pl. 53: 10–12*) with grave goods from different time periods was dug into the destruction layers of the courtyard. It seems that the area of the former ecclesiastical complex retained a special significance for some people who buried their dead there even after the abandonment of the settlement. An Early Medieval ring with a rivet (*Pl. 47: 1*) found in the destruction layer which belongs to the same time as grave 21 also points to later visits to this place.

## 2.4 VODNI ZBIRALNIK

V ruševini so bili najdeni srp (*t. 53: 13*), železna puščična ost s trikotno ploščato konico in tulom (*t. 53: 15*) ter ploščat kamen, morda brus (*t. 53: 14*).

## 2.4 WATER CISTERN

In the destruction layer, a sickle (*Pl. 53: 13*), an iron arrowhead with a triangular flat head (*Pl. 53: 15*), and a flat stone, possibly a whetstone (*Pl. 53: 14*) were found.

## 2.5 LITERATURA / BIBLIOGRAPHY

Tonovcov grad. Naselbinski ostanki in interpretacija / Tonovcov grad. Settlement remains and interpretation = Ciglencčki, Modrijan, Milavec 2011.

AHUMADA SILVA, I., P. LOPREATO in / and A. TAGLIAFERRI (ur. / eds.) 1990, *La necropoli di S. Stefano 'in Pertica'. Campagne di scavo 1987-1988.* – Cividale.

ANDRAE, R. 1973, Untersuchungen zur Verbreitung und Datierung karolingerzeitlichen Millefioriglasperlen in Europa. – *Acta prehistorica et archaeologica* 4, 101–198.

ARENA, M. S., P. DELOGU, L. PAROLI, M. RICCI, A. ROVELLI, L. SAGUI in / and L. VENDITTELLI 2004, The city of Rome from Antiquity to the Middle Ages. Archaeology and history. – V / In: *Crypta Balbi*, Museo Nazionale Romano, Roma, 50–93.

ASPÖCK, E. in / and P. STADLER 2003, Die langobardenzeitlichen Gräber von Brunn am Gebirge, Flur Wolfholz, Niederösterreich. – *Archaeologia Austriaca* 87, 169–233.

BASSI, C. 1996, Catalogo e osservazioni di carattere tipo-cronologico. – V / In: U. Raffaelli (ur. / ed.), *Oltre la porta. Serrature, chiavi e forzieri dalla preistoria all'età moderna nelle Alpi orientali*, 84–93, Trento.

BAUSOVAC, M. 2003, Poznoantični kovinski predmeti z Gradca pri Prapretnem (Spätantike Metallgegenstände von Gradec bei Prapretno). – *Arheološki vestnik* 54, 315–324.

BAVDEK, A. 2005, Rimsko žarno grobišče Volarije pri Žirjah na Krasu (The Roman cremation cemetery at Volarije near Žirje on Kras). – *Arheološki vestnik* 56, 235–262.

BENINGER, E. in / and H. MITSCHA-MÄRHEIM 1970, *Das langobardische Gräberfeld von Nikitsch, Burgenland.* – Wissenschaftliche Arbeiten aus dem Burgenland 43.

BERGEN, C. 2005, *Technologische und kulturhistorische Studien zu Bleifunden im 1. Jahrtausend.* – Universitätsforschungen zur prähistorische Archäologie 125.

BIERBRAUER, V. 1987, *In villino-Ibligo in Friaul 1. Die römische Siedlung und das spätantik-frühmittelalterliche Castrum.* – Münchner Beiträge zur Vor- und Frühgeschichte 33.

BIERBRAUER, V. 1992a, Zwei romanische Bügelfibeltypen des 6. und 7. Jahrhunderts im mittleren Alpenraum. Ein Betrag zur Kontinuitäts- und Sie-

dlungsgeschichte. – V / In: *Festschrift zum 50jährigem Bestehen des Institutes für Ur- und Frühgeschichte der Leopold-Franzens-Universität Innsbruck.* Universitätsforschungen zur prähistorischen Archäologie 8, 37–74.

BIERBRAUER, V. 1992b, Kreuzfibeln in der mittelalpinen romanischen Frauentracht des 5.–7. Jahrhunderts: Trentino und Südtirol. – V / In: *Miscellanea di Studi in onore di Giulia Mastrelli Anzilotti.* Archivio per l'Alto Adige. Rivista di studi alpini 86, 1–26.

BITENC, P. 2001, [različne kataloške številke / various catalogue Nos.]. – V / In: Bitenc, Knific 2001.

BITENC, P. 2002, Iron combs for wool or flax processing. – *Instrumentum* 15 (juin 2002), 27–30.

BITENC, P. in / and T. KNIFIC (ur. / eds.) 2001, *Od Rimljanov do Slovanov. Predmeti.* – Ljubljana.

BLÄNSDORF, J. 2005, The curse tablets from the sanctuary of Isis and Mater Magna in Mainz. – *Revista Internacional de Investigación sobre Magia y Astrología Antiguas* 5, 11–26.

BOLTA, A. 1981, *Rifnik pri Šentjurju. Poznoantična naselbina in grobišče / Rifnik – spätantike Siedlung und Gräberfeld.* – Katalogi in monografije 19.

BOŽIČ, D. 2005, Die spätromischen Hortfunde von der Gora oberhalb von Polhov Gradec. – *Arheološki vestnik* 56, 293–368.

BOŽIČ, D. in / and S. CIGLENEČKI, 1995, Zenonov tremis in poznoantična utrdba Gradec pri Veliki Strmici / Der Tremissis des Kaisers Zeno und die spätromische Befestigung Gradec bei Velika Strmica. – *Arheološki vestnik* 46, 247–277.

BÖHME, H. W. 1974, *Germanische Grabfunde des 4. bis 5. Jahrhunderts zwischen unterer Elbe und Loire.* – Münchner Beiträge zur Vor- und Frühgeschichte 19.

BÖHME, H. W. 1986, Das Ende der Römerherrschaft in Britannien und die Angelsächsische Besiedlung Englands im 5. Jahrhundert. – *Jahrbuch des römisch-germanischen Zentralmuseums Mainz* 33/2, 469–574.

BÖHME, H. W. 1994, Der Frankenkönig Childerich zwischen Attila und Aëtius. Zu den Goldgriffspathen der Merowingerzeit. – V / In: C. Dobiat (ur. / ed.), *Festschrift für Otto-Herman Frey zum 65. Geburtstag*, Marburger Studien zur Vor- und Frühgeschichte 16, 69–110.

BRAS KERNEL, H. 2002, *Ženski grob z zlatim nakitom iz Lajha v Kranju.* – Diplomaska naloga / Undergraduate thesis, Oddelek za arheologijo, Filozofska fakulteta Univerze v Ljubljani, Ljubljana.

- BREUER, E. 2005, *Byzanz an der Donau*. – Archaeological Introductions 2.
- BROZZI, M. 1987, Anelli preciosi conservati al Museo di Cividale. – *Memorie storiche forogiuliesi* 66, 237–241.
- BROZZI, M. 1989, *La popolazione Romana nel Friuli Longobardo*. – Udine.
- BUGARSKI, I. 2005, A contribution to the study of lamellar armours. – *Starinar* 55, 161–179.
- BULLINGER, H. 1969, *Spätantike Gürtelbeschläge*. – Dissertationes Archaeologicae Gandenses 12.
- BUORA, M. 1997, Nuovi studi sulle *plumbatae* (=mattiobarbuli?). A proposito degli stanziamenti militari nell'Illirico occidentale e nell'Italia orientale nel IV e all'inizio del V secolo. – *Aquileia nostra* 68, 237–246.
- BUORA, M., A. CANDUSSIO in / and P. PRÖTTEL 1990, Spätantike Scharnierfibeln aus der Region Friuli–Venezia Giulia. – *Germania* 68/2, 612–627.
- BUSULADŽIĆ, A. 2010, *Morfologija antičkih fibula iz zbirke Zemaljskog muzeja Bosne i Hercegovine / The morphology of Antique Fibulae in the collection of the National Museum of Bosnia and Herzegovina*. – Sarajevo.
- CALLMER, J. 1997, Beads and glass production in Scandinavia and the Baltic region c. AD 600–1100: a general outline. – V / In: U. von Freedon, A. Wiczorek (ur. / eds.), *Perlen. Archäologie. Techniken. Analysen. Kolloquien zur Vor- und Frühgeschichte* 1, 197–202, Bonn.
- CAPPELE, T. 1994, *Die Miniaturkette von Szilágysomlyó (Simleul Silvaniei)*. – Universitätsforschungen zur prähistorischen Archäologie 22.
- CAVADA, E. 1996, Chiavi e complementi di chiusura di età romana e altomedievale: contesti di rinvenimento e cronologia di alcuni esempi trentini. – V / In: U. Raffaelli (ur. / ed.), *Oltre la porta. Serrature, chiavi e forzieri dalla preistoria all'età moderna nelle Alpi orientali*, 94–103, Trento.
- CAVADA, E. 2002, Militaria tardoantichi (fine IV–V secolo) dalla valle dell'Adige e dalle aree limitrofe. L'informazione archeologica. – V / In: M. Buora (ur. / ed.), *Miles Romanus. Dal Po al Danubio nel Tardoantico*, 139–162, Pordenone.
- CHEVALIER, P. 1999, Les installations liturgiques des églises d'Istrie du V<sup>e</sup> au VII<sup>e</sup> siècle. – *Hortus artium medievalium* 5, 105–117.
- CIAMPOLTRINO, G. 1991, Capraia, Livorno. Materiali di corredo tardoantico. – *Bolletino di archeologia* 7, 54–59.
- CIGLENEČKI, S. 1985, Potek alternativne ceste Siscija–Akvileja na prostoru zahodne Dolenjske in Notranjske v času 4. do 6. stoletja (Der Verlauf der Alternativstrasse Siscia–Aquileia im Raum von Westdolenjsko und Notranjsko in der Zeitspanne vom 4. bis zum 6. Jh.). – *Arheološki vestnik* 36, 255–284.
- CIGLENEČKI, S. 1994a, Höhenbefestigungen als Siedlungsgrundeinheit der Spätantike in Slovenien. – *Arheološki vestnik* 45, 239–266.
- CIGLENEČKI, S. 1994b, Poznoantična naselbina Tonovcov grad pri Kobaridu. – *Kronika* 42/1, 1–14.
- CIGLENEČKI, S. 1994c, Scavi nell'abitato tardoantico di Tonovcov grad presso Caporetto (Kobarid), Slovenia. Raporto preliminare. – *Aquileia nostra* 65, 185–207.
- CIGLENEČKI, S. 1995, Izvrednotenje / Auswertung. – V / In: J. Dular, S. Ciglenečki, A. Dular, Kučar. *Železnodobno naselje in zgodnjekrščanski stavbni kompleks na Kučarju pri Podzemlju / Kučar. Eisenzeitliche Siedlung und frühchristlicher Gebäudekomplex auf dem Kučar bei Podzemelj*, Opera Instituti Archaeologici Sloveniae 1, 134–190.
- CIGLENEČKI, S. 1997a, *Tonovcov grad pri Kobaridu. Vodnik*. – Ljubljana, Kobarid.
- CIGLENEČKI, S. 1997b, Poznoantični in slovanški sledovi na Kobariškem. – V / In: *Kobarid*, 17–28, Kobarid.
- CIGLENEČKI, S. 1999a, Cerkev, krstilnice in zgodnjekrščanska središča. – V / In: *Zakladi tisočletij. Zgodovina Slovenije od neandertalcev do Slovanov*, 329–331, Ljubljana.
- CIGLENEČKI, S. 1999b, Zaton antičnega sveta. – V / In: *Zakladi tisočletij. Zgodovina Slovenije od neandertalcev do Slovanov*, 334–336, Ljubljana.
- CIGLENEČKI, S. 1999c, Staroselci - poslednji antični prebivalci. – V / In: *Zakladi tisočletij. Zgodovina Slovenije od neandertalcev do Slovanov*, 337–340, Ljubljana.
- CIGLENEČKI, S. 1999d, Tonovcov grad pri Kobaridu. – V / In: *Zakladi tisočletij. Zgodovina Slovenije od neandertalcev do Slovanov*, 349–352, Ljubljana.
- CIGLENEČKI, S. 2000, *Tinje nad Loko pri Žusmu. Poznoantična in zgodnjeresrednjevska naselbina / Tinje oberhalb von Loka pri Žusmu. Spätantike und frühmittelalterliche Siedlung*. – Opera Instituti Archaeologici Sloveniae 4.
- CIGLENEČKI, S. 2005, L'insediamento fortificato su altura di Tonovcov grad presso Caporetto e i suoi dintorni in età romana e paleo-slava. – V / In: A. Tilatti (ur. / ed.), *La cristianizzazione degli Slavi nell'arco alpino orientale*, 93–108, Roma, Gorizia.
- CIGLENEČKI, S. 2008, *Castra* und Höhensiedlungen vom 3. bis 6. Jahrhundert in Slowenien. – V / In: H. Steuer, V. Bierbrauer, M. Hoepfer (ur. / eds.), *Höhensiedlungen zwischen Antike und Mittelalter von den Ardennen bis zur Adria*. Ergänzungsbände zum Reallexikon der Germanischen Altertumskunde 58, 481–532, Berlin, New York.
- CIGLENEČKI, S. in / and T. MILAVEC 2009, The defence of north-eastern Italy in the first decennia of the 5th century. – *Forum Iulii* 33, 177–189.
- CIGLENEČKI, S., Z. MODRIJAN in / and T. MILAVEC 2011, *Tonovcov grad. Naselbinski ostanki in interpretacija / Tonovcov grad. Settlement remains and interpretation*. – Opera Instituti Archaeologici 23.

- CIPOT, D. 2003, *Križne fibule v Sloveniji*. – Diplomaska naloga / Undergraduate thesis, Oddelek za arheologijo, Filozofska fakulteta Univerze v Ljubljani, Ljubljana.
- CIURLETTI, G. 1997, Oggetti d'ornamento nel Trentino–Alto Adige nell'Alto Medioevo. – V / In: L. Endrizzi, F. Marzatico (ur. / eds.), *Ori delle Alpi*, 437–536, Trento.
- CUNJA, R. 1996, *Poznoantični in srednjeveški Koper. Arheološka izkopavanja na bivšem Kapucinskem vrtu v letih 1986–1987 v luči drobnih najdb od 5. do 9. Stoletja / Capodistria tardoromana e altomedievale. Lo scavo archeologico nell'ex orto dei Cappuccini negli anni 1986-1987 alla luce dei reperti dal V al IX secolo d. C.* – Koper.
- CUNJA, R. in / and M. MLINAR (ur. / eds.) 2010, *S fibulo v fabulo. Fibule iz Istre, s Krasa, iz Notranjske in Posočja med prazgodovino in zgodnjim srednjim vekom / Con la fibula nella storia. Fibule dall'Istria, dal Carso, dalla Carniola Interna e dall'Isontino tra preistoria e alto medioevo*. – Koper.
- DANNHEIMER, H. 1968, *Lauterhofen im frühen Mittelalter*. – Materialhefte zur bayerischen Vorgeschichte 22.
- DE MARCHI, M. 2000, La necropoli di Trezzo d'Adda, località San Martino. – V / In: E. A. Arslan, M. Buora (ur. / eds.), *L'oro degli Avari*, 166–171, Milano.
- DEIMEL, M. 1987, *Die Bronzekleinfunde vom Magdalensberg*. – Kärntner Museumsschriften 71.
- DOLENZ, H. 1998, *Eisenfunde aus der Stadt auf dem Magdalensberg*. – Kärntner Museumsschriften 75.
- DULAR, J., S. CIGLENEČKI in / and A. DULAR 1995, *Kučar. Železnodobno naselje in zgodnjekrščanski stavbni kompleks na Kučarju pri Podzemlju/ Kučar. Eisenzeitliche Siedlung und frühchristlicher gebäudekomplex auf dem Kučar bei Podzemelj*. – Opera Instituti Archaeologici Sloveniae 4.
- EGAN, G. 1998, *The Medieval Household. Daily living c. 1150–1450*. – Medieval finds from excavations in London 6.
- FELGENHAUER-SCHMIEDT, S. 1993, *Das Kappel ("Die Kåpile") ob Jadersdorf*. – Aus Forschung und Kunst 27.
- FEUGÈRE, M. 1992, Les instruments de chasse, de pêche at d'agriculture. – *Lattara* 5, 139–169.
- FEUGÈRE, M. 1995, Les spatules à cire à manche figuré. – V / In: W. Czysz, C.-M. Hüssen, H.-P. Kuhnen, C. S. Sommer, G. Weber (ur. / eds.), *Provinzialrömische Forschungen. Festschrift für Günter Ulbert zum 65. Geburtstag*, 321–338, Espelkamp.
- FEUGÈRE, M. 1996, L'armement du Bas-Empire. – V / In: M. Reddé, J. Bénard (ur. / eds.), *L'armée romaine en Gaule*, 267–278, Paris.
- FEUGÈRE, M. in / and M. GUŠTIN 2000 (ur. / eds.), *Iron, blacksmiths and tools. Ancient European crafts*. – Monographies Instrumentum 12.
- FREEDEN, U. von 1979, Untersuchungen zu merowingerzeitlichen Ohringen bei den Alamannen. – *Bericht der Römisch-Germanischen Kommission* 60, 227–442.
- FREEDEN, U. von 1991, Awarische Funde in Süddeutschland? – *Jahrbuch des römisch-germanischen Zentralmuseums Mainz* 38/2, 593–627.
- FREMERSDORF, F. 1955, *Die fränkische Reihengräberfeld Köln-Müngersdorf*. – Germanische Denkmäler der Völkerwanderungszeit 6.
- GAITZSCH, W. 1980, *Eiserne römische Werkzeuge*. – BAR. International Series 78 (i).
- GARAM, È. 2001, *Funde byzantinischer Herkunft in der Awarenzeit vom Ende des 6. bis zum Ende des 7. Jahrhunderts*. – Monumenta Avarorum Archaeologica 5.
- GARBSCH, J. 1965, *Die norisch-pannonische Frauentracht im 1. und 2. Jahrhundert*. – Münchner Beiträge zur Vor- und Frühgeschichte 11.
- GASPARI, A., M. GUŠTIN, I. LAZAR in / and B. ŽBONA TRKMAN, 2000, Late Roman tool finds from Celje, Gradišče at Zbelovska gora and Sv. Pavel above Vrtovin (Slovenia). – V / In: M. Feugère, M. Guštin (ur. / eds.), *Iron, blacksmiths and tools. Ancient European crafts*. Monographies Instrumentum 12, 187–203, Montagnac.
- GEISLER, H. 1998, *Das frühbairische Gräberfeld Straubing-Bajuwarenstraße I. Archäologischer Katalog: Text: Funde* – Internationale Archäologie 30.
- GIESLER, U. 1974, Datierung und Herleitung der Vogelförmigen Riemenzungen. – V / In: G. Kossack, G. Ulbert (ur. / eds.), *Festschrift für Joachim Werner zum 65. Geburtstag*. Münchner Beiträge zu Vor- und Frühgeschichte. Ergänzungsband 1/II, 521–543.
- GLASER, P. 2002, Gräberfelder der Ostgotenzeit (493–536) in Iuenna/Globasniz. – *Fundberichte aus Österreich* 41, 431–438.
- GUGL, C. 1995, *Die römischen Fibeln aus Virunum*. – Klagenfurt.
- GUIRAUD, H. 1989, Bagues et anneaux à l'époque romaine en Gaule. – *Gallia* 46, 173–211.
- HEINDEL, I. 1993, Werkzeuge zur Metallbearbeitung des 7./8.–12./13. Jahrhunderts zwischen Elbe/Saale und Bug. – *Zeitschrift für Archäologie* 27, 337–379.
- HENIG, M. 1978, *A corpus of Roman Engraved Gemstones from British Sites*. – BAR. British series 8.
- HENNING, J. 1987, *Südosteuropa zwischen Antike und Mittelalter*. – Schriften zur Ur- und Frühgeschichte 42.
- HÖCK, A. 2003, *Archäologische Forschungen in Teriola 1*. – Fundberichte aus Österreich, Materialhefte A 14, Wien.
- HÜBENER, W. 1972, Gleicharmige Bügelfibeln der Merowingerzeit in Westeuropa. – *Madriider Mitteilungen* 13.
- IBLER, U. 1991, *Studien zum Kontinuitätsproblem am Übergang von der Antike zum Mittelalter in Nord- und Westjugoslawien*. – Neobavljena doktorska disertacija / Unpublished doctoral thesis, Bonn.

- IONIȚĂ, I. 1998, Die Fibeln mit umgeschlagenem Fuss Almgren Gruppe VI/1. – V / In: J. Kunow (ur. / ed.), *100 Jahre Fibelformen nach Oscar Almgren*, Forschungen zur Archäologie im Land Brandenburg 5, 231–240, Wünsdorf.
- ISTENIČ, J. 1999, *Poetovio, zahodna grobišča I / Poetovio, the western cemeteries I*. – Katalogi in monografije 32.
- ISTENIČ, J. 2005, Evidence for a very late Republican siege at Grad near Reka in Western Slovenia. – *Carnuntum Jahrbuch* 2005, 77–87.
- JAMES, S. 2004, *Excavations at Dura Europos: Final Report VII: The arms and armour and other military equipment*. – London
- JESSOP, O. 1996, A new artefact typology for the study of Medieval arrowheads. – *Medieval archaeology* 40, 192–205.
- JOBST, W. 1975, *Die römischen Fibeln aus Lauriacum*. – Forschungen aus Lauriacum 10.
- JOSIPOVIČ, D. 1982, Bašelj. – *Varstvo spomenikov* 24, 181–183.
- KARO, Š. 2001, [kataloški enoti / cat. nos. 169, 239]. – V / In: Bitenc, Knific 2001.
- KATIČ, M. 1996–1997, Grobovi s Gospina Otoka u Solinu (Graves from Our Lady of the Island in Solin). – *Diadora* 18–19, 351–364.
- KAZANSKI, M. 1994, Les plaque-boucles méditerranéennes des V<sup>e</sup>–VI<sup>e</sup> siècles. – *Archéologie médiévale* 24, 137–198.
- KELLER, E. 1971, *Die spätrömischen Grabfunde in Südbayern*. – Münchner Beiträge zur Vor- und Frühgeschichte 14.
- KLASINC, R. 1999, *Gradec pri Veliki Strmici v obdobju preseljevanja ljudstev*. – Diplomaska naloga / Undergraduate thesis., Oddelek za arheologijo, Filozofska fakulteta Univerze v Ljubljani, Ljubljana.
- KLEEMAN, J. 1992, *Grabfunde des 8. und 9. Jahrhunderts im nördlichen Randgebiet des Karolingerreiches*. – Neobjavljena doktorska disertacija / Unpublished doctoral thesis, Bonn.
- KNAVS, M. and M. MLINAR 2000–2004, Robič, arheološko najdišče sv. Volar. – *Varstvo spomenikov. Poročila* 39–41, 169–170.
- KNIFIC, T. 1979, Vranje pri Sevnici. Drobne najdbe z Ajdovskega gradca (Vranje bei Sevnica. Kleinfunde aus Ajdovski gradec). – *Arheološki vestnik* 30, 732–785.
- KNIFIC, T. 1995, Vojščaki iz mesta Karnija. – *Kranjski zbornik* 1995, 23–40, Kranj.
- KNIFIC, T. 2001, [različne kataloške enote / various cat. Nos.]. – V / In: Bitenc, Knific 2001.
- KNIFIC, T. 2002, Na stičišču treh svetov. Arheološki podatki o Goriški v zgodnjem srednjem veku (At the crossing-point of three worlds. Archaeological data of the Gorizia region in the Early Middle Ages). – *Goriški letnik* 29, 5–30.
- KNIFIC, T. 2004, Arheološki sledovi blejskih prebivalcev. – V / In: *Bled 1000 let. Blejski zbornik* 2004, 93–118, Radovljica.
- KNIFIC, T. 2005, Gospe iz mesta Karnija. – *Kranjski zbornik* 2005, 331–343, Kranj.
- KNIFIC, T. 2007, Zgodnjesrednjeveški pozlačeni predmeti z Gradišča nad Bašljem (Slovenija) / Early Medieval gilded artefacts from Gradišče nad Bašljem (Slovenia). – *Prilozi Instituta za arheologiju u Zagrebu* 24, 317–326.
- KNIFIC, T. and A. PLETERSKI 1981, Staroslovansko grobišče Dlesc pri Bodeščah (Die Altslawische Nekropole Dlesc bei Bodešče). – *Arheološki vestnik* 32, 482–523.
- KNIFIC, T. in / and M. SAGADIN, 1991, *Pismo brez pisave. Arheologija o prvih stoletjih krščanstva na Slovenskem / A Letter Without Written Words. Archaeology of the first Centuries of Christianity in Slovenia*. – Ljubljana.
- KOCH, U. 1968, *Die Grabfunde der Merowingerzeit aus dem Donautal um Regensburg*. – Germanische Denkmäler der Völkerwanderungszeit, Serie A, Bd. 10.
- KOCH, U. 1991, *Der Runde Berg bei Urach VII. Frühgeschichtliche Funde von den Hängen und Terrassen und Nachträge zu Urach V und VI*. – Heidelberger Akademie der Wissenschaften, Kommission für Alamannische Altertumskunde, Schriften 13.
- KOCH, U. 1997, Polychrome Perlen in Württemberg/Nordbaden. – V / In: U. von Freedon, A. Wiczorek (ur. / eds.), *Perlen. Archäologie. Techniken. Analysen. Kolloquien zur Vor- und Frühgeschichte* 1, 143–148, Bonn.
- KOCH, U. 2001, *Das alamannisch-fränkische Gräberfeld bei Pleidelsheim*. – Forschungen und Berichte zur Vor- und Frühgeschichte in Baden-Württemberg, Band 60.
- KOROŠEC, P. 1961, Poskus delitve slovanske materialne kulture na področju Karantanije (Ein Versuch der typologischen Unterscheidung in den slawischen materiellen Kultur in Karantanien). – *Zgodovinski časopis* 15, 157–194.
- KOROŠEC, P. 1968, Elementi preseljevanja narodov na nekropoli na Ptujem gradu (Elemente aus der Periode der Völkerwanderung in der Nekropole auf dem Burghügel von Ptuj). – *Arheološki vestnik* 19, 287–294.
- KOS, P. 1988, *Die Fundmünzen der römischen Zeit in Slowenien I*. – Berlin.
- KOS, P. in / and A. ŠEMROV, 1995, *Die Fundmünzen der römischen Zeit in Slowenien III*. – Berlin.
- KRASNIK, B. 2009, Tkanje, ostanki tkanin in oblačila starih Slovanov (The Weaving, Textile finds and Clothing of the Ancient Slavs). – *Arheo* 26, 63–107.
- KREMPUŠ, R. 2000, Krvavica bei Vransko in Slowenien, Höhensiedlung des 3. bis 6. Jahrhunderts. – V / In: M. Feugère, M. Guštin (ur. / eds.), *Iron, blacksmiths*

and tools. *Ancient European crafts*. Monographies Instrumentum 12, 209–231, Montagnac.

LADSTÄTTER, S. 2000, *Die materielle Kultur der Spätantike in der Ostalpen. Eine Fallstudie am Beispiel der westlichen Doppelkirchenanlage auf dem Hemmaberg*. – Mitteilungen der prähistorischen Kommission 35.

LEBEDINSKY, I. 2001, *Arms et guerriers barbares au temps des grandes invasions (IV<sup>e</sup>–VI<sup>e</sup> siècle après J.-C.)*. – Paris.

LOSERT H. in A. PLETERSKI, 2003, *Altenerding in Oberbayern. Struktur des frühmittelalterlichen Gräberfeldes und 'Ethnogenese' der Bajuwaren*. – Berlin, Bamberg, Ljubljana.

MARTIN, M. 1991, *Das spätrömisch-frühmittelalterliche Gräberfeld von Kaiseraugst, Kt. Aargau*. – Basler Beiträge zur Ur- und Frühgeschichte 5A.

MARTIN, M. 2000, Mit Sax und Gürtel ausgestattete Männergräber des 6. Jahrhunderts in der Nekropole von Kranj (Slowenien). – V / In: R. Bratož (ur. / ed.), *Slovenija in sosednje dežele med antiko in karolinško dobo. Začetki slovenske etnogeneze. / Slowenien und die Nachbarländer zwischen Antike und karolingischer Epoche. Anfänge der slowenischen Ethnogeneze*. Situla 39/I, 141–196, Ljubljana.

MARUŠIČ, B. 1986–1987, Starohrvatska nekropola u Žminju (Altkroatische Nekropole in Žminj). – *Histria archaeologica* 17–18, 5–125.

MARUŠIČ, B. 1995, *Istra i sjevernojadranski prostor u ranom srednjem vijeku (materijalna kultura od 7. do 11. stoljeća)*. – Monografije i katalogi 4.

MENGHIN, W. 1983, *Das Schwert im Frühen Mittelalter*. – Wissenschaftliche Beibände zum Anzeigen des Germanischen Nationalmuseums 1.

MENIS, G. C. (ur. / ed.) 1990, *I Longobardi*. – Milano.

MERTEN, J. 1987, Die Esra-Miniatur des Codex Amiatinus. Zu Autorenbild und Schreibgerät. – *Trierer Zeitschrift* 50, 301–319.

MILAVEC, T. 2007, Prispevek h kronologiji S-fibul v Sloveniji / A contribution to the chronology of S-fibulae in Slovenia. – *Arheološki vestnik* 58, 333–355.

MILAVEC, T. 2009, Crossbow fibulae of the 5<sup>th</sup> and 6<sup>th</sup> centuries in the south-eastern Alps. / Samostrelne fibule 5. in 6. stoletja na prostoru jugovzhodnih Alp. – *Arheološki vestnik* 60, 223–248.

MILAVEC, T. 2011, Poznorimske pasne garniture z jezdecami iz jugovzhodnih Alp in Panonije / Late Roman belt sets with riders from the southeastern Alps and Pannonia. – *Prilozi Instituta za arheologijo u Zagrebu* 28, (v tisku / in print).

MILAVEC, T. in / and Z. MODRIJAN, 2007, L'abitato tardoantico di Tonovcov grad alla luce dei reperti ceramici e metallici / Poznoantična naselbina Tonovcov grad v luči kovinskih in keramičnih najdb. – V / In: G. Banchig, S. Magnani, A. Pessina (ur. / eds.) *Terre*

*d'incontro. Contatti e scambi lungo le Valli del Natisone e dell'Isonzo dall'antichità al medioevo*, 107–127, Cividale.

MILETIĆ, N. 1970, Ranosrednovjekovna nekropola u Rakovčanima kod Prijedora. – *Glasnik Zemaljskog muzeja BiH* 25, 119–178.

MLINAR, M. 2010, Nova arheološka odkritja s Tolminskega. – V / In: *Tolminski zbornik 2010*, 250–257.

MODRIJAN, Z. 2011, Continuity in late antiquity Slovenian fortified hilltop settlements. – V / In: O. Heinrich-Tamáska (ur. / ed.), *Keszthely-Fenekpuszta im Kontext spätantiker Kontinuitätsforschung zwischen Noricum und Moesia*, 157–172, Budapest.

MÖLLER, J. 1976–1977, Zur Funktion der Nadel in der fränkisch-alamannischen Frauentracht. – *Jahrbuch des römisch-germanischen Zentralmuseums Mainz* 23–24, 14–53.

MÜLLER, R. 2010, *Die Gräberfelder vor der Südmauer der Befestigung von Keszthely-Fenekpuszta*. – Castellum Pannonicum Pelsonense 1.

NEPPER, I. 1996, Sarrétudvári–Poroshalom. – V / In: I. Fodor (ur. / ed.), *The ancient Hungarians*, Budapest, 277–281.

ODAR, B. 2006, The archer from Carnium / Lokostrelec iz Karnija. – *Arheološki vestnik* 57, 243–275.

OSMUK, N. 2001, Fibula (kat. / cat. no. 131). – V / In: Bitenc, Knific 2001.

PAVLIN, P. in / and J. DULAR 2007, Prazgodovinska višinska naselja v Posavskem hribovju (Prehistoric hilltop settlements in the Posavje hills). – *Arheološki vestnik* 58, 65–120.

PETRU, P. 1967, Zgodnjesrednjeveška naselbina na Polhograjski gori nad Polhovim Gradcem (Die frühmittelalterliche Ansiedlung auf der Polhograjska gora ob Polhov gradec). – *Arheološki vestnik* 18, 453–460.

PFLAUM, V. 2000, *Claustra Alpium Iuliarum in barbari*. – Magistrsko delo / MA thesis. Oddelek za arheologijo, Filozofska fakulteta Univerze v Ljubljani, Ljubljana.

PFLAUM, V. 2002, Spätrömische kerbschnittverzierte Gürtelbeschläge im Gebiet des heutigen Slowenien. – *Antichità Altoadriatiche* 51, 259–287.

PIETSCH, M. 1983, Die römischen Eisenwerkzeuge von Saalburg, Feldburg und Zugmantel. – *Saalburg Jahrbuch* 39, 5–132.

PIRKMAJER, D. 2001, [različne kataloške enote / various cat. nos.]. – V / In: Bitenc, Knific 2001.

PIRLING, R. 1979, *Das römisch-fränkische Gräberfeld von Krefeld-Gellep 1964/1965*. – Germanische Denkmäler der Völkerwanderungszeit, Ser. B, Bd. 10.

PLETERSKI, A. 1999, Zgodnji srednji vek. – V / In: *Zakladi tisočletij. Zgodovina Slovenije od neandertalcev do Slovanov*, 370–373, Ljubljana.

PLETERSKI, A. 2008, Lauterhofen. Strukturen des frühmittelalterlichen Gräberfeldes und chronologisches Verhältnis zu Altenerding. – *Slovenská archeológia* 56, 61–80.

POHANKA, R. 1986, *Die eisernen Agrargeräte der römischen Kaiserzeit in Österreich. Studien zur römischen Agrartechnologie in Rätien, Noricum und Pannonien.* – BAR. International Series 298.

POPOVIĆ, I. 1990, Les activités professionnelles à Caričin grad vers la fin du VI<sup>e</sup> et le début du VII<sup>e</sup> siècle d'après les outils de fer. – V / In: B. Bavant, V. Kondić, L. M. Spieser (ur. / eds.), *Caričin grad II*, 269–306, Belgrade-Rome.

PRÖTTEL, P. M. 1988, Zur Chronologie der Zwiebelknopffibeln. – *Jahrbuch des römisch-germanischen Zentralmuseums Mainz* 35/1, 347–372.

QUAST, D. 1993, *Die merowingerzeitlichen Grabfunde aus Gültlingen.* – Forschungen und Berichte zur Vor- und Frühgeschichte in Baden-Württemberg 52.

RIEMER, E. 2000, *Romanische Grabfunde des 5.–8. Jahrhunderts in Italien.* – Internationale Archäologie 57.

RIHA, E. 1986, *Römisches Toilettgerät und medizinische Instrumente aus Augst und Kaiseraugst.* – Forschungen in Augst 6.

RIHA, E. 1990, *Die römische Schmuck aus Augst und Kaiseraugst.* – Forschungen in Augst 10.

RIHA, E. 1994, *Die römischen Fibeln aus Augst und Kaiseraugst. Die Neufunde seit 1975.* – Forschungen in Augst 18.

SAGADIN, M. 1988, *Kranj. Križišče Iskra. Nekropola iz časa preseljevanja ljudstev in staroslovanskega obdobja. / Kranj. Iskra Crossroads. A cemetery from the Migration Period and the Early Slavic Period.* – Katalogi in monografije 24.

SAGADIN, M. 2000, Late antique wood-working tools from Grdavov hrib near Kamnik (Slovenia) – V / In: M. Feugère, M. Guštin (ur. / eds.), *Iron, blacksmiths and tools. Ancient European crafts.* Monographies Instrumentum 12, 205–208, Montagnac.

SASSE, B. 2001, *Ein frühmittelalterliches Reihengräberfeld bei Eichstetten am Kaiserstuhl.* – Forschungen und Berichte zur Vor- und Frühgeschichte in Baden-Württemberg, Band 75.

SCHILBACH, E. 2001, Mass und Gewicht in Byzanz. – V / In: C. Stiegemann (ur. / ed.), *Byzanz. Das Licht aus dem Osten. Kult und Alltag im Byzantinischen reich vom 4. bis 15. Jahrhundert*, 244–247, Paderborn.

SCHMIDT, B. 1970, *Die späte Völkerwanderungszeit in Mitteldeutschland. Katalog (Südteil)* – Veröffentlichungen des Landesmuseums für Vorgeschichte in Halle 25.

SCHRETTTER, S. 1993, Fibeln vom Hemmaberg. Ausgrabungen 1990–1992. – *Carinthia I* 183, 187–203.

SCHULZE, M. 1977, *Die spät-kaiserzeitlichen Armbrustfibeln mit festem Nadelhalter.* – Antiquitas, Reihe 3.

SCHULZE-DÖRRLAMM, M. 1986, Romanisch oder germanisch? Untersuchungen zu den Armbrust- und Bügelknopffibeln des 5. und 6. Jahrhunderts nach Chr. aus den Gebieten westlich des Rheins und südlich

der Donau. – *Jahrbuch des römisch-germanischen Zentralmuseums Mainz* 33/2, 593–720.

SCHÜTZ, N. M. 2003, *Eisenfunde aus der Stadt auf dem Magdalensberg II.* – Kärntner Museumsschriften 77.

SIEGMANN, M. 1997, Die Perlen des frühmittelalterlichen Gräberfeldes von Liebenau, Kr. Nienburg/Weser (Niedersachsen). – V / In: U. von Freeden, A. Wiczorek (ur. / eds.), *Perlen. Archäologie. Techniken. Analysen.* Kolloquien zur Vor- und Frühgeschichte 1, 133–142, Bonn.

SIEGMANN, M. 2003, *Bunte Pracht – die Perlen der frühmittelalterlichen Gräberfelder von Libenau, Kreis Nienburg/Weser, und Dörverden, Kreis Verden/Aller.* Teil 2. – Beiträge zur Ur- und Frühgeschichte Mitteleuropas 28.

SIEGMANN, M. 2004, *Bunte Pracht – die Perlen der frühmittelalterlichen Gräberfelder von Libenau, Kreis Nienburg/Weser, und Dörverden, Kreis Verden/Aller.* Teil 3. – Beiträge zur Ur- und Frühgeschichte Mitteleuropas 28.

SIVEC, I. 1997, Poznoantično orožje na Slovenskem (Spätantike Waffen in Slowenien). – *Arheološki vestnik* 48, 143–151.

SLABE, M. 1975, *Dravljje. Grobišče iz časov preseljevanja ljudstev (Dravljje – necropoli dall'epoca della migrazione dei popoli).* – Situla 16.

SLABE, M. 1978, Kultur na sled iz obdobja preseljevanja ljudstev (Belt buckle of the Migration period from Ljubljana). – *Arheološki vestnik* 29, 425–431.

SLABE, M. 1990, O prstanih iz časa preseljevanja ljudstev na Slovenskem (Über die Fingerringe aus der Völkerwanderungszeit in Slowenien). – *Arheološki vestnik* 41, 455–464.

SOKOL, V. 1994, Das spätantike Kastrium auf dem Kuzelin bei Donja Glavnica. – *Arheološki vestnik* 45, 199–209.

SOKOL, V. 1998, *Rimski metal Kuzelina / Roman metalwork from Kuzelin.* – Zagreb.

SOMMER, M. 1984, *Die Gürtel und Gürtelbeschläge des 4. und 5. Jahrhunderts im römischen Reich.* – Bonner Hefte zur Vorgeschichte 22.

STARE, V. 1980, *Kranj. Nekropola iz časa preseljevanja ljudstev / [Kranj. Nekropole aus der Völkerwanderungszeit].* – Katalogi in monografije 18.

STAŠŠÍKOVÁ-ŠTUKOVSKÁ D. in / and A. PLŠKO, 1997, Typologische und technologische Aspekte der Perlen aus dem mittelalterlichen Gräberfeld in Borovce. – V / In: U. von Freeden, A. Wiczorek (ur. / eds.), *Perlen. Archäologie. Techniken. Analysen.* Kolloquien zur Vor- und Frühgeschichte 1, 259–274, Bonn.

STIEGEMANN C. in / and M. WEMHOFF (ur. / eds.) 1999, 799: *Kunst und Kultur der Karolingerzeit. Karl der Grosse und Papst Leo III. in Paderborn.* Band 1. – Paderborn.

STEINKLAUBER, U. 2002, *Das spätantike Gräberfeld auf dem Frauenberg bei Leibnitz, Steiermark.* – Fundberichte aus Österreich. Materialhefte Reihe A 10.



STEUER, H. 1997, Krieger und Bauern – Bauernkrieger. Die gesellschaftliche Ordnung der Alamannen. – V / In: *Die Alamannen*, 275–287, Stuttgart.

STRMČNIK, M. 1997, Mariborsko–bistriško območje v poznorimski dobi (Der Raum Maribor und Bistrica in spätrömischer Zeit). – *Arheološki vestnik* 48, 269–288.

SZAMEIT, E. 1995, Ein Völkerwanderungszeitliches Werkzeugdepot mit Kleinfunden aus Niederösterreich. Ein Vorbericht. – V / In: J. Tejral, H. Friesinger, M. Kazanski (ur. / eds.), *Neue Beiträge zur Erforschung der Spätantike im mittleren Donaauraum*, Spisy archeologického ústavu AV ČR Brno 8, 233–257, Brno.

ŠONJE, A. 1980–1981, Ostaci groblja kod sela Klistići jugozapadno od Tinjana (I resti della necropoli presso il villaggio di Klistići a sud-ovest di Antignana). – *Histria archaeologica* 11–12, 67–88.

ŠPEHAR, P. 2010, *Materijalna kultura iz ranovizantijskih utvrđenja u Đerdapu*. – Cahiers des Portes de Fer. Monographies 7.

ŠTUKL, J. 2004, Poznoantični depo s Puštala nad Trnjem (A hoard dating to late Antiquity from Puštala above Trnje). – *Arheološki vestnik* 55, 415–427.

TEJRAL, J. 1988a, Zur Chronologie und Deutung der Südöstlichen Kulturelemente in der frühen Völkerwanderungszeit Mitteleuropas. – V / In: W. Menghin, W. Püllhorn (ur. / eds.), *Die Völkerwanderungszeit in Karpatenbecken*, 11–46, Nürnberg.

TEJRAL, J. 1988b, Zur Chronologie der frühen Völkerwanderungszeit im mittleren Donaauraum. – *Archaeologia Austriaca* 72, 223–304.

TEMPELMANN-MAÇZYŃSKA, M. 1985, *Die Perlen der römischen Kaiserzeit und der frühen Phase der Völkerwanderungszeit im mitteleuropäischen Barbaricum*. – Römisch-Germanische Forschungen 43.

TERŽAN, B., F. LO SCHIAVO in / and N. TRAMPUŽ-OREL 1985, *Most na Soči (S. Lucia) II*. – Katalogi in monografije 23.

THÖRLE, S. 2001, *Gleicharmige Bügelfibeln des frühen Mittelalters*. – Universitätsforschungen zur prähistorischen Archäologie 81.

UBOLDI, M. in / and M. VERITÀ 2003, Scientific Analysis of Glasses from Late Antique and Early Medieval Archaeological Sites in Italy. – *Journal of Glass Studies* 45, 115–137.

UENZE, S. 1992, *Die spätantiken Befestigungen von Sadovec (Bulgarien)*. – Münchner Beiträge zur Vor- und Frühgeschichte 43.

Van der SANDEN, W. A. B. 1993, Fragments of a lorica hamata from a barrow at Fluitenberg, Netherlands. – *Journal of Roman military equipment studies* 4, 1–8.

VIDA, T. 2009, Local or foreign Romans? The problem of the Late Antique population of the 6<sup>th</sup>–7<sup>th</sup> centuries AD in Pannonia. – V / In: D. Quast (ur. / ed.), *Foreigners in the Early Medieval Europe. Thirteen studies on Early Medieval Mobility*, Monographien des Römisch-Germanischen Zentralmuseums 78, 233–259, Mainz.

VIDRIH PERKO V. in / and M. SAGADIN 2004, Gorenjska v antiki. – *Kamniški zbornik* 17, 207–224, Kamnik.

VINSKI, Z. 1967, Kasnoantički starosjedioci u salonitanskoj regiji prema arheološkoj ostavštini predslavenskog supstrata. – *Vjesnik za arheologiju i historiju dalmatinsku* 69, 5–86.

VINSKI, Z. 1968, Krstoliki nakit epohe seobe naroda u Jugoslaviji (Kreuzförmiger Schmuck der Völkerwanderungszeit in Jugoslawien). – *Vjesnik arheološkog muzeja u Zagrebu* 3/III, 103–168.

VINSKI, Z. 1980, Ovrednotenje grobnih pridatkov / Betrachtungen zur Auswertung des Grabbeigabengrundstoffes der Völkerwanderungszeitlichen Nekropole in Kranj. – V / In: V. Stare, *Kranj. Nekropola iz časa preseljevanja ljudstev ljudstev / [Kranj. Nekropole aus der Völkerwanderungszeit]*, Katalogi in monografije 18, 17–32, Ljubljana.

VINSKI, Z. 1989, Razmatranja o iskopavanjima u Kninu na nalazištu Greblje. – *Starohrvatska prosvjeta* III/19, 5–73.

VOSS, H.-U. 1998, Die Bugelknopf fibeln. Almgren Gruppe VI/2, Fig. 185 und 186. – V / In: J. Kunow (ur. / ed.), *100 Jahre Fibelformen nach Oscar Almgren*, Forschungen zur Archäologie im Land Brandenburg 5, 271–282, Wünsdorf.

WAMSER, L. 2004, *Die Welt von Byzanz - Europas östliche Erbe*. – Schriftenreihe der Archäologischen Staatssammlung 4.

WERNER, J. 1950, *Das alamannische Fürstengrab von Wittislingen*. – München.

WERNER, J. 1962, *Die Langobarden in Pannonien. Beiträge zur Kenntnis der langobardischen Bodenfunde vor 586*. – Abhandlungen der Bayerischen Akademie der Wissenschaften, Phil.-Hist. Klasse N.F. 55.

ZOTOVIĆ, L. 1980, Nekropola iz vremena seobe naroda sa uže gradske teritorije Viminacija. – *Starinar* 31, 95–115.



## 3. STEKLENE NAJDBE

### 3. GLASS FINDS

Tina MILAVEC

Na Tonovcovem gradu je stekla največ v stavbi 1 in okrog nje, najdenih je bilo 118 opredeljivih odlomkov (*t.* 54–57; 58: 1–8). V drugih stavbah, vodnem zbiralniku ter sklopu cerkva je bilo steklenih posod bistveno manj (*t.* 58: 9–21; 59–63).

Stekleno gradivo so v glavnem odlomki (ustja in noge) kozarcev na visoki nogi iz naravno obarvanega zelenorumenega stekla. Do sedaj opravljene kemijske analize stekla s Tonovcovega gradu kažejo, da je bila uporabljena steklena masa Levantine I,<sup>1</sup> kot velja tudi za večino najdišč rimskega obdobja v zahodnem delu imperija (npr. Zucchiati et al. 2007; Arletti et al. 2010).

Poleg kozarcev na visoki nogi, nekaj odlomkov steklenih svetilk ter precej okenskega stekla je bilo najdenih še nekaj posameznih odlomkov drugega steklenega posodja: kozarcev brez noge, steklenic, skled, balzamarijev ali manjših steklenič in krožnika. Veliko odlomkov steklenega posodja je tako majhnih, da sta določanje posameznih tipov in datacija pogosto vprašljiva. Nekatere oblike ustij in nog ali dnov se pojavljajo pri več tipih in v več stoletjih, zato je previdnost potrebna.

Kjer bo mogoče, bomo uporabljali tipologijo Irene Lazar (2003a), poleg te pa tudi osnovno opredelitev Clasine Isings (1957) za lažje primerjave z drugimi objavami. Za poznoantično steklo 5. in 6. st., torej večino gradiva, se bomo naslonili predvsem na tipološke delitve Danièle Foy (1995).

V obravnavi stekla s Tonovcovega gradu le izjemo ma navajamo analogije iz drugih jugovzhodnoalpskih najdišč, saj sledi v poglavju 3.7 pregled poznantičnega stekla iz vse Slovenije.

#### 3.1 STAVBA 1

##### 3.1.1 OBLIKE 1.–3. STOLETJA

Pri stavbi 1 sta bila najdena dva majhna odlomka čaše in skodelice iz zgodnje antike. Delček ustja iz svetlomodrega stekla (*t.* 54: 1, *sl.* 3.1: 1) spada v skupino

<sup>1</sup> Analize še niso zaključene in objavljene, za preliminarne podatke se zahvaljujem Ž. Šmitu in Th. Rehrenu.

At Tonovcov grad most of the glass was found in and around building 1, where 118 definable fragments were discovered (*Pls.* 54–57; 58: 1–8). Other buildings, the water cistern, and the ecclesiastical complex revealed a significantly smaller number of glass vessels (*Pls.* 58: 9–21; 59–63).

Glass material is mainly represented by fragments (rims, stems and feet) of stemmed goblets made of naturally coloured green-yellow glass. Chemical analyses of glass from Tonovcov grad performed up until now show that the Levantine I glass mass was used,<sup>1</sup> the same as was used at most of the Roman period sites in the western part of the Empire (e.g. Zucchiati et al. 2007; Arletti et al. 2010).

Beside stemmed goblets, a few fragments of glass lamps and quite a lot of window glass, a few individual fragments of other glass vessels were found: beakers, bottles, bowls, balsamaria or smaller bottles, and a plate. Many fragments of glass vessels are so small that the assignment of individual types and dating are often questionable. Some forms of rims and feet or bases appear in several types and in several centuries thus caution is needed.

Where possible the typology of Irene Lazar (2003a) will be followed, complemented by the basic classification of Clasina Isings (1957) for easier comparisons with other publications. For the Late Antique glass of the 5<sup>th</sup> and 6<sup>th</sup> century, therefore for most of the material, we will mostly rely on the typological classification of Danièle Foy (1995).

During the discussion of glass from Tonovcov grad analogies to other southeastern Alpine sites are stated only exceptionally because the following chapter 3.7 deals with the overview of the Late Antique glass from the entire Slovenian territory.

<sup>1</sup> These analyses have not yet been completed and published, thus I thank Ž. Šmit and Th. Rehren for the preliminary data.

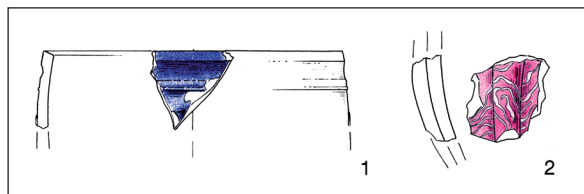

Sl. 3.1: Odlomka steklene čaše in skodelice (t. 54: 1–2). Steklo. M. = 1:2.

Fig. 3.1: Fragments of a glass beaker and bowl (Pl. 54: 1-2). Glass. Scale = 1:2.

3.2.1. po I. Lazar (Isings 12), to je med kroglaste čaše s horizontalnimi vrezi, datirane v 1. st. (Lazar 2003a, 87).

Del ostenja rebraste skodelice je iz vijoličasto-belega marmoriranega stekla (t. 54: 2; sl. 3.1: 2). Najden je bil sicer v prizidku v zgodnj srednjeveški plasti, vendar spada v skupino 2.1.4. po I. Lazar (2003a, 37–41), to je med rebraste skodelice, narejene v kalupu, ki so datirane v 1. st. (Isings 3).

Za stavbo 1 je bil v premešani plasti najden tudi odlomek ročaja vrčka (t. 54: 3). Na podlagi tako majhnega odlomka ni mogoče rekonstruirati oblike posode. Opora za palec, vidna na odlomku, je sploščena, kar naj bi bilo značilno za vrče med 2. in 4. st. Zgodnejši vrči imajo oporo oblikovano v zanko (Lazar 2003a, 131).

### 3.1.2 KOZARCI NA VISOKI NOGI

V izkopnem polju stavbe 1 je bilo najdenih veliko odlomkov kozarcev na votli visoki nogi (t. 54: 7–26; 55; 56). Kozarci imajo visoke noge (t. 56: 11–36), ki so izvlečene iz istega kosa stekla kot recipient in zapognjene navznoter in navzgor (votle noge), in zataljena ustja (t. 54: 7–26; 55; 56: 1–10). Nekatera od zataljenih ustij so lahko pripadala tudi kozarcem brez noge (glej spodaj), katerih dna so bila prav tako najdena, vendar v precej manjšem številu. Vsa zataljena ustja obravnavamo tukaj.

Skupno je bilo najdenih 26 visokih nog, in sicer v plasteh faze PA 2 (t. 56: 11–14,16–17,20,22–23,25–28,30,32,35), ruševini (t. 56: 15,29), zgodnj srednjeveški plasti (t. 56: 21,31) ter premešani plasti (t. 56: 18–19,24,33–34,36). Po Bierbrauerjevi razdelitvi kozarcev z Invillina (Bierbrauer 1987, 271–282) jih 17 spada v tip Ia (močno izbočena stojna ploskev: t. 56: 12–15,19–21,23–26,28,32–36) in 9 v Ib (položna stojna ploskev z izrazitim robom: t. 56: 11,16–18,22,27,29–31). Nobena pa ne sodi v tipa Ic (položna stojna ploskev brez izrazitega roba) ali II (ploska stojna ploskev).

Pri zelo majhnih odlomkih ustij je opredeljevanje v tipe nezanesljivo. Najdenih je bilo 57 odlomkov ustij, pojavljajo pa se v plasteh faze PA 2 (t. 54: 7–10,14–16,18–21,24,26; 55: 1–2,4–6,8,12,14,16–19,21–27; 56: 1,3,6), ruševini (t. 55: 10), zgodnj srednjeveški plasti (t. 54: 13) ter premešani plasti (t. 54: 12,17,22,25; 55:

## 3.1 BUILDING 1

### 3.1.1 FORMS OF THE 1<sup>ST</sup>-3<sup>RD</sup> CENTURY

Near building 1 two small fragments of a beaker and a bowl were found which belong to the early Antiquity. A piece of a rim made of light blue glass (Pl. 54: 1, Fig. 3.1: 1) belongs to group 3.2.1. according to I. Lazar (Isings 12), i.e. among spherical beakers with wheel-cut lines, dated to the 1<sup>st</sup> century AD (Lazar 2003a, 87).

A part of a wall of a ribbed bowl is made of purple-white marbled glass (Pl. 54: 2; Fig. 3.1: 2). It was found in the outhouse in the Early Medieval layer but belongs to group 2.1.4. according to I. Lazar (2003a, 37–41), i.e. among ribbed bowls made in a mould, which are dated to the 1<sup>st</sup> century (Isings 3).

Behind building 1 a fragment of a jug handle was found in a mixed layer (Pl. 54: 3). On the basis of such a small fragment it is not possible to reconstruct the shape of the vessel. The thumb rest, visible on the fragment, is flattened, which is supposedly typical for jugs between the 2<sup>nd</sup> and 4<sup>th</sup> century. The thumb rest on earlier jugs is shaped into a loop (Lazar 2003a, 131).

### 3.1.2 STEMMED GOBLETs

In the excavation area of building 1 many fragments of hollow stemmed goblets (Pls. 54: 7–26; 55; 56) were found. Goblets have stems and feet (Pl. 56: 11–36), which are pulled out from the same piece of glass as the recipient and folded in- and upwards (hollow stems), and fire-rounded rims (Pls. 54: 7–26; 55; 56: 1–10). Some of these fire-rounded rims could have been parts of beakers (see below), bases of which were also found but in a much smaller number. All fire-rounded rims are discussed here.

All together 26 stems and feet were found and these were discovered in layers of phase LA 2 (Pl. 56: 11–14,16–17,20,22–23,25–28,30,32,35), in the destruction layer (Pl. 56: 15,29), in an Early Medieval layer (Pl. 56: 21,31), and in a mixed layer (Pl. 56: 18–19,24,33–34,36). According to Bierbrauer's classification of goblets from Invillino (Bierbrauer 1987, 271–282), 17 belong to type Ia (strongly convex foot: Pl. 56: 12–15,19–21,23–26,28,32–36) and 9 to type Ib (slightly convex foot with a marked ring: Pl. 56: 11,16–18,22,27,29–31). None belong to types Ic (slightly convex foot without a marked ring) or II (flat foot).

Classification into types is unreliable with very small rim fragments. 57 rim fragments were found which appear in layers of phase LA 2 (Pls. 54: 7–10,14–16,18–21,24,26; 55: 1–2,4–6,8,12,14,16–19,21–27; 56: 1,3,6), destruction layer (Pl. 55: 10), Early Medieval layer (Pl. 54: 13), and a mixed layer (Pls. 54: 12,17,22,25; 55: 3,7,9,11,13,15,20; 56: 2). 49 probably belong to type B (cylindrical: Pls. 54: 7–15,17–18,20–26; 55: 1–6,8–13,15–

3,7,9,11,13,15,20; 56: 2). 49 jih predvidoma spada v tip B (cilindrične oblike: *t. 54: 7–15,17–18,20–26; 55: 1–6,8–13,15–27; 56: 1–6*) in 4 v tip C (konične oblike, *t. 54: 16,19; 55: 7,14*) po Bierbrauerjevi delitvi. Štirje odlomki ustij so premajhni za opredelitev (*t. 56: 7–10*), tip A (zvončaste oblike) pa na Tonovcovem gradu ni zastopan. Od ustij z Invillina se tonovška razlikujejo predvsem po tem, da so precej bolj izvihana.

Kozarci na visoki nogi (tip Isings 111: Isings 1957, 139–140) so izredno priljubljena in daleč najpogostejša oblika steklenega posodja v Sredozemlju med koncem 5. in 8. st. (Sagui 1993, 129; Foy 1995, 207–209; Sternini 1995, 259; Lafli, Gürlér 2010, 434; glej tudi poglavje 3.7.2).

Okras iz belih ali modrih nataljenih niti, značilen za konec 5. in začetek 6. st. (Foy 1995, 204), se pojavi le na petih odlomkih ustij z območja stavbe 1 (*t. 55: 6–7; 56: 7,9–10*). Mogoče je tudi, da so odlomki premajhni in da so bili v nekaterih primerih kozarci okrašeni nižje pod ustjem na ostenju, ki se ni ohranilo. Značilno je, da je bilo steklo okrasa manj kvalitetno od tistega, iz katerega so izdelani kozarci, zato je pogosto odpadlo. V tem primeru na kozarcih ostane le odtis nataljenih niti v obliki horizontalnih prog oz. črt (npr. *t. 54: 16; 55: 12,27; 56: 5*). Bele niti naj bi bile značilnejše za zahodni, modre pa za vzhodni del imperija (Fünfschilling 2006, 145).

### 3.1.3 KOZARCI NA NIZKI NOGI

Dno kozarca na prstanasti nogi (*t. 58: 3*) je bilo najdeno v premešani plasti. Pripadalo bi lahko cilindričnemu kozarcu na prstanasti nogi (Isings 85a), tip 3.6.1. po I. Lazar, ki je datiran v 2. in 3. st. (Lazar 2003a, 102–104), oziroma podobni posodi. Dna s prstanastimi nogami so bila najdena npr. na Hrušici (Ulbert 1981, t. 49: 35–36, 38–39), pa tudi na najdiščih 5. in 6. st. Na višinskih postojankah, kot so Tinje (Ciglencečki 2000, t. 7: 18), Rifnik (Bolta 1981, t. 21: 74) in Ančnikovo gradišče (Ravnik 2006, 78, t. 51: 523), so bili takšni kozarci lahko v rabi v 5. ali 6. st. ali pa so le ostanki starejše poselitve.

Dve nogi kozarcev na nizki konični nogi (*t. 58: 4–5*) sta bili najdeni prva v plasti faze PA 2, druga pa v plasti zunanje hodne površine stavbe 1 (SE 24). Prvi primerek (*t. 58: 4*) spada v tip Foy 14, drugi primerek (*t. 58: 5*) pa v tip Foy 19. Tip Foy 14 je datiran večinoma v prvo polovico 5. st. (Foy 1995, 200), Foy 19 pa v celo 5. st. (Foy 1995, 200). V Italiji so te oblike kozarcev redke in postavljene v 5. st. (Sternini 1995, sl. 17: 17–18). Podobna noga je bila najdena v cerkvi na Invillinu (Bierbrauer 1988, sl. 23: 5), na estrihu vzhodnega stranskega prostora, ki je bil v uporabi med 4. in začetkom 7. st. (Bierbrauer 1988, 78).

27; 56: 1–6) and 4 to type C (conical, *Pls. 54: 16,19; 55: 7,14*) according to Bierbrauer. Four rim fragments are too small to classify (*Pl. 56: 7–10*), while type A (bell-shaped) is not represented at Tonovcov grad. Rims from Tonovcov grad differ from those of Invillino mostly in the fact that they are much more everted.

Stemmed goblets (type Isings 111: Isings 1957, 139–140) are an extremely popular and by far the most frequent form of glass vessels in the Mediterranean between the end of the 5<sup>th</sup> and the 8<sup>th</sup> century (Sagui 1993, 129; Foy 1995, 207–209; Sternini 1995, 259; Lafli, Gürlér 2010, 434; see also chapter 3.7.2).

The decoration of white or blue trailing, characteristic of the end of the 5<sup>th</sup> and the beginning of the 6<sup>th</sup> century (Foy 1995, 204), appears only on five rim fragments in the area of building 1 (*Pls. 55: 6–7; 56: 7,9–10*). It is also possible that the fragments are too small and that some goblets were decorated lower down beneath the rim on the part which was not preserved. It is typical that the glass of the ornament was of lesser quality than the glass of the recipient thus it frequently fell off. In this case, only impressions of trailings in the shape of horizontal lines remain on the goblets (e.g. *Pls. 54: 16; 55: 12,27; 56: 5*). White threads were supposedly more characteristic for the western and the blue for the eastern part of the Empire (Fünfschilling 2006, 145).

### 3.1.3 FOOTED BEAKERS

The ring base (*Pl. 58: 3*) was found in a mixed layer. It could belong to cylindrical beakers with a ring base (Isings 85a), type 3.6.1. according to I. Lazar, which are dated to the 2<sup>nd</sup> and 3<sup>rd</sup> centuries (Lazar 2003a, 102–104), or to a similar vessel. Ring bases were found for example at Hrušica (Ulbert 1981, Pl. 49: 35–36,38–39), and also at the sites of the 5<sup>th</sup> and 6<sup>th</sup> centuries. At the hilltop settlements like Tinje (Ciglencečki 2000, Pl. 7: 18), Rifnik (Bolta 1981, Pl. 21: 74), and Ančnikovo gradišče (Ravnik 2006, 78, Pl. 51: 523) such beakers could have been used during the 5<sup>th</sup> or 6<sup>th</sup> century or could just be the remains of an older settlement.

Two feet of beakers on a low conical foot (*Pl. 58: 4–5*) were found, the first in a layer of phase LA 2, and the other in the layer representing the outer walking surface of structure 1 (SU 24). The beaker (*Pl. 58: 4*) belongs to type Foy 14 and the other one (*Pl. 58: 5*) to type Foy 19. Type Foy 14 mostly dates to the first half of the 5<sup>th</sup> century (Foy 1995, 200) and Foy 19 to the entire 5<sup>th</sup> century (Foy 1995, 202). In Italy these forms of beakers are rare and assigned to the 5<sup>th</sup> century (Sternini 1995, Fig. 17: 17–18). A similar foot was found in the church at Invillino (Bierbrauer 1988, Fig. 23: 5), on the mortar floor of the eastern annex which was used between the 4<sup>th</sup> and the beginning of the 7<sup>th</sup> century (Bierbrauer 1988, 78).

## 3.1.4 KOZARCI BREZ NOGE

Od kozarcev brez noge se je na območju stavbe 1 ohranilo le eno ustje (*t. 54: 6*), kos ostenja (*t. 54: 5*) in 12 vbočenih dnov (*t. 57: 1-12*).

Odrezano izvihano ustje (*t. 54: 6*), ki ga lahko pripišemo različici kozarca Isings 106c (ali mogoče 109), je bilo najdeno pred stavbo v plasti zunanje hodne površine (SE 24) iz časa faze PA 2.

Majhen odlomek ostenja z nataljeno modro stekleno kapljo (*t. 54: 5*), ki spada v tip Isings 107b (Lazar 2010, 119-120), je bil odkrit v plasti iz faze PA 2.

Vbočena dna (*t. 57: 1-12*) so bila najdena v plasteh faze PA 1 (*t. 57: 1-2,4*) in PA 2 (*t. 57: 3,5-7,11-12*), zgodnj srednjeveški plasti (*t. 57: 8*) in premešani plasti (*t. 57: 9-10*). Večina najverjetneje pripada tipu Isings 106 (*t. 57: 1-6,9-12*), dve pa tipu Isings 109 (*t. 57: 7-8*).

Glavna razlika med tipoma je oblikovanost dna, ki je pri tipu Isings 106 le nekoliko vbočeno, pri tipu Isings 109 pa je toliko vbočeno, da je skoraj preoblikovano v nogo (Lazar 2003a, 119). Kozarci brez noge se pojavljajo v celem imperiju in so večinoma postavljeni v čas od 4. do najmanj sredine 5. st. (Isings 1957, 126-138; Lazar 2003a, 116-120). Ker so pogosta najdba na najdiščih 5. in tudi 6. st., se je njihova izdelava in uporaba očitno nadaljevala še po sredini 5. st. (glej pogl. 3.7.3).

## 3.1.5 STEKLENICE

Lijakasto ustje (*t. 57: 13*), najdeno v plasti faze PA 2 v okolici stavbe 1, pripada steklenici, predvidoma tipu Isings 132 (Isings 1957, 160-161), ki je sicer datiran v 4. in 5. st. Lijakasta ustja imajo tudi steklenice, ki se pojavljajo kasneje, konec 5. in v 6. st. (npr. Sternini 1995, sl. 20: 56,58).

Odlomki vratu in ostenja z rebrasto površino (risana le *t. 57: 15-16*) so ležali v plasti, ki pripada fazi PA 1. To so bili deli steklenice z ostenjem, pihanim v kalup, tip 6.2.3. po I. Lazar oz. tip Isings 101, ki je datiran od poznega 3. do zgodnjega 5. st. (Lazar 2003a, 141-142).

Med steklenice spada tudi odlomek ostenja (*t. 57: 14*), najden v premešani plasti, ki ga zaradi slabe ohranjenosti ne moremo pripisati določeni obliki.

Posebno zanimiva sta odlomka ostenja z notranjim cevastim rebrom, ki sta bila najdena v premešani plasti pri stavbi 1 (*t. 57: 17-18*). Primerjavi jima lahko najdemo med steklenim gradivom S. Giulie v Brescii. M. Uboldi (Uboldi 1998, sl. 14-15) ju interpretira kot steklenici, datirani v konec 6. st., in opozarja na v celoti ohranjen primerek s takšnim ostenjem, lijakastim ustjem, kroglastim recipientom in vbočnim dnom, ki je bil najden v tako imenovanem Gisulfovem grobu v Čedadu, datiranim v sredino 7. st. (Menis 1990, 475, X.191s). Še dva odlomka takšnega ostenja sta bila najdena na Monte

## 3.1.4 BEAKERS

In the area of building 1 only one rim (*Pl. 54: 6*), a piece of a wall (*Pl. 54: 5*) and 12 concave bases (*Pl. 57: 1-12*) are preserved.

A cut everted rim (*Pl. 54: 6*), which can be assigned to a beaker of the variant Isings 106c (or possibly 109), was found in front of the building in the layer representing the outer walking surface (SU 24) from the time of phase LA 2.

A small fragment of a wall with a blue glass drop (*Pl. 54: 5*), belonging to type Isings 107b (Lazar 2010, 119-120), was discovered in a layer of phase LA 2.

Concave bases (*Pl. 57: 1-12*) were found in layers of phase LA 1 (: *Pl. 57: 1-2,4*) and LA 2 (*Pl. 57: 3,5-7,11-12*), Early Medieval layer (*Pl. 57: 8*), and a mixed layer (*Pl. 57: 9-10*). Most of them probably belong to type Isings 106 (*Pl. 57: 1-6,9-12*) and two belong to type Isings 109 (*Pl. 57: 7-8*).

The main difference between these two types is the shape of the base, which is in type Isings 106 only slightly concave, while in type Isings 109 it is so concave that it almost transforms into a foot (Lazar 2003a, 119). Beakers appear in the whole Empire and are mostly set into the time from the 4<sup>th</sup> to at least the middle of the 5<sup>th</sup> century (Isings 1957, 126-138; Lazar 2003a, 116-120). Since they are a frequent find also at sites of the 5<sup>th</sup> and 6<sup>th</sup> century, their production and use must have continued after the middle of the 5<sup>th</sup> century (see chapter 3.7.3).

## 3.1.5 BOTTLES

A funnel mouth (*Pl. 57: 13*), found in a layer of phase LA 2 in the surroundings of building 1, belongs to a bottle, probably of type Isings 132 (Isings 1957, 160-161) which is dated to the 4<sup>th</sup> and 5<sup>th</sup> century. Funnel-shaped rims are found also on bottles appearing later on, at the end of the 5<sup>th</sup> and in the 6<sup>th</sup> century (e.g. Sternini 1995, Fig. 20: 56,58).

Fragments of the neck and wall with ribbed surface (drawn only *Pl. 57: 15-16*) were lying in a layer belonging to phase LA 1. These represent parts of a bottle with a mould-blown body, type 6.2.3. according to I. Lazar or type Isings 101, which is dated from the late 3<sup>rd</sup> to early 5<sup>th</sup> century (Lazar 2003a, 141-142).

A fragment of a wall (*Pl. 57: 14*), found in a mixed layer, which due to poor preservation cannot be assigned to a particular form also belongs among bottles.

Two fragments of a wall with an inner tubular rib, found in a mixed layer near building 1 (*Pl. 57: 17-18*) are particularly interesting. Their analogies can be found among the glass material from S. Giulia in Brescia. M. Uboldi (Uboldi 1998, Figs. 14-15) interprets them as bottles dated to the end of the 6<sup>th</sup> century and draws attention to a completely preserved item with such wall,

Barro, datirana med konec 5. in sredino 6. st. (Uboldi, Verità 2003, sl. 5: 11–12).

Tipologija in kronologija steklenic sta natančneje izdelani le za poznorimsko obdobje. Pozneje, v drugi polovici 5. in v 6. st., se steklenice vsaj v zahodnem delu Sredozemlja ne pojavljajo pogosto, še redkeje pa so dovolj dobro ohranjene, da bi lahko izdelali zanesljivo razdelitev. Vsaj v osnovnih potezah se nadaljujejo oblike 4. in 5. st. – lijakasta ali cilindrična ustja, kroglast ali cilindričen recipient, večinoma brez ročajev in nog (Sagui 1993, sl. 3; Sternini 1995, 260, 262; Foy 1995, 209–210; Fünfschilling 2006, sl. 3: 11).

### 3.1.6 SVETILKE

V okolici stavbe 1 so bili v plasti faze PA 2 (*t. 57: 21*) in premešani plasti (*t. 57: 19–20,22*) prepoznani štirje odlomki ustij in ročajev svetilk (*t. 57: 19–22*).

Tipologijo svetilk za zahodni del Sredozemlja je naredila M. Uboldi (1995). V Sloveniji (glej pogl. 3.7.5) je večinoma zastopan le njen tip I.1 s koničnim recipientom, vbočenim dnom in tremi ročajčki za obešanje, ki so pogosto druge barve kot recipient (Isings 134 oz. tip 9.2.1. po I. Lazar; Lazar 2003a, 197–200). Le eno tonovsko ustje (*t. 57: 21*) spada v podtip Uboldi I.2, pri katerem je recipient kroglast (Uboldi 1995, sl. 2).

Steklene svetilke so zelo pogoste najdbe v zgodnje-krščanskih cerkvah. Uporabljali so jih od druge polovice 4. do 8. st. v zahodnem delu Sredozemlja, v vzhodnem pa še precej dlje (Uboldi 1995, 105; Stern 1999, 480, 482; Ferri 2006, 184). Po vzoru cerkva so jih začeli uporabljati tudi v bivalnih prostorih (O'Hea 2007, 236), a v jugovzhodnih Alpah jih v večjih količinah srečamo le v cerkvenih stavbah (Ladstätter 2000, 183; za Slovenijo glej pogl. 3.7.5).

### 3.1.7 BALZAMARIJ

V plasti faze PA 2 je bil najden odlomek dna balzamarija (*t. 58: 1*). Po obliki bi lahko spadal med cevaste balzamarije z zajedo na ostenju, skupina Lazar 8.6.2., ki so datirani v 2. in 3. st. (Lazar 2003a, 175–177), vendar so balzamariji oz. majhne stekleničke ostajale v rabi tudi skozi poznoantično-zgodnjerednjeveško obdobje, kot nam kažejo predsem najdbe iz Italije (Sternini 1989, 110; Sagui 1993, 130–131, sl. 3, 9; Sternini 1995, 262). Zdi se, da v zahodnem Sredozemlju niso tako pogosti, da bi jih lahko ustrezno tipokronološko opredelili (pregledi D. Foy za južno Francijo [1995] in S. Fünfschilling za Kartagino [2006; 2010] jih skoraj ne omenjajo). Tako je za posamezne kose brez ustreznih kontekstov težko ugotoviti, ali so ostanki iz starejšega obdobja ali spadajo v poznoantični čas. Na Tonovcovem gradu je bilo nekaj ostankov manjših stekleničk oz. balzamarijev najdenih tudi v dobro oprede-

funnel-shaped rim, globular recipient and concave base that was found in the so-called tomb of Gisulf in Cividale del Friuli, dated to the mid-7<sup>th</sup> century (Menis 1990, 475, X.191s). Another two fragments of such walls were found at Monte Barro and are dated between the end of the 5<sup>th</sup> and the middle of the 6<sup>th</sup> century (Uboldi, Verità 2003, Fig. 5: 11-12).

The typology and chronology of bottles is defined in detail only for the Late Roman period. Later, in the second half of the 5<sup>th</sup> and in the 6<sup>th</sup> century bottles rarely appear in the western part of the Mediterranean and are even more rarely preserved enough to enable a certain division. Basically at least, the shapes of the 4<sup>th</sup> and 5<sup>th</sup> century continue – funnel-shaped or cylindrical rims and a globular or cylindrical recipient, mostly without handles and feet (Sagui 1993, Fig. 3; Sternini 1995, 260, 262; Foy 1995, 209-210; Fünfschilling 2006, Fig. 3: 11).

### 3.1.6 LAMPS

Near building 1 in a layer of phase LA 2 (*Pl. 57: 21*) and a mixed layer (*Pl. 57: 19-20,22*) four fragments of lamp rims and handles were recognised (*Pl. 57: 19-22*).

The typology of lamps for the western part of the Mediterranean was made by M. Uboldi (1995). In Slovenia (see chapter 3.7.5), mostly only her type I.1 with a conical recipient, concave base and three small handles which are often of a different colour than the recipient is represented (Isings 134 i.e. type 9.2.1. after I. Lazar; Lazar 2003a, 197-200). Only one rim from Tonovcov grad (*Pl. 57: 21*) belongs to subtype Uboldi I.2 which has a globular recipient (Uboldi 1995, Fig. 2).

Glass lamps are very frequent finds within the Early Christian churches. They were used from the second half of the 4<sup>th</sup> to the 8<sup>th</sup> century in the western part of the Mediterranean and much longer in the eastern part (Uboldi 1995, 105; Stern 1999, 480, 482; Ferri 2006, 184). At first they only appeared in churches but later the lamps started to be used also in private houses (O'Hea 2007, 236). In the Southeastern Alps however they appear in significant numbers only in ecclesiastical buildings (Ladstätter 2000, 183; for Slovenia see chapter. 3.7.5).

### 3.1.7 BALSAMARIUM

In a layer of phase LA 2 a fragment of a balsamarium base was found (*Pl. 58: 1*). Considering the shape it could belong among the tubular balsamaria with a constriction on the body, group Lazar 8.6.2., which are dated to the 2<sup>nd</sup> and 3<sup>rd</sup> century (Lazar 2003a, 175-177). Nevertheless, balsamaria or small bottles remained in use also through the Late Antique-Early Medieval period as is revealed primarily through finds from Italy (Sternini 1989, 110;

ljenem stratigrafskem kontekstu faze PA 2 v cerkvenem sklopu (glej pogl. 3.3.3), tako da bi lahko tudi za odlomek iz stavbe 1 domnevali enako datacijo.

### 3.1.8 KROŽNIK

Odlomek noge krožnika (*t.* 58: 2) je bil najden v plasti faze PA 2. Uvrstili bi ga lahko v tip 10c po D. Foy, ki je z gradivom iz južne Francije datiran v pozno 5. in zgodnje 6. st. (Foy 1995, 205). V Italiji se lahko pojavlja tudi v 6. in deloma še v 7. st. (Sagui 1993, sl. 3, 6). Odprte oblike steklenega posodja (sklede in krožniki) so v zahodnem delu Sredozemlja po sredini 5. st. redke. V Sloveniji edino primerjavo tonovškemu kosu najdemo v Fizinah pri Portorožu (Gaspari et al. 2007, 178–179, t. 7: 209), v plasteh pristaniškega kompleksa, ki so datirane od druge polovice 4. do 6. st. (Gaspari et al. 2007, 170; glej pogl. 3.7.7).

### 3.1.9 SKODELICE IN SKLEDE

Cevasto ustje (*t.* 58: 6) je bilo najdeno v plasti iz faz PA 1/2. Pripada lahko skodelici s cilindričnim ostenjem in cevastim ustjem tipa 2.5.1. po I. Lazar, ki je datiran v drugo polovico 1. in v 2. st. (Lazar 2003a, 80–81). Ta tip skodelic je v Augstu stratigrafsko datiran še vse do 4. st. (tip AR 109.1: Rütli 1991, 50). Podobno ustje je bilo najdeno v cerkvi na Invillinu, ki je datirana med 4. in začetek 7. st. (Bierbrauer 1988, 78, sl. 23: 3). Ustje bi lahko pripadalo tudi svetilki z ročaji, ki imajo pogosto cevasta ustja (Bierbrauer 1988, sl. 23: 1,7,13–17). Primerjavi tonovski skodelici najdemo tudi med gradivom s Fizin pri Portorožu (Gaspari et al. 2007, t. 7: 202–203). Opredeljeni sta kot skodelici s širokim, navzdol zapognjenim ustjem, kakršne v Italiji najdemo v 5. in 6. st. (Gaspari et al. 2007, 179; Sternini 1995, 243; 2001, 25). Na podlagi majhnega odlomka in maloštevilnih bližnjih analogij se je težko odločiti, kam bi ta odlomek uvrstili. Ker je bil najden v premešani plasti, lahko spada v čas med 4. in 6. st.

Odlomek ustja (*t.* 58: 7) pripada skledi tipa Foy 21a, ki je lahko okrašena z nataljenimi belimi nitmi in je datirana v konec 5. in začetek 6. st. (Foy 1995, 205). Najden je bil v plasti faze PA 2. Takšna skleda je bila najdena tudi v naselbini iz 5.–6. st. na Monte Barru (Uboldi 1991, t. LV: 7). Veliko podobnih je bilo najdenih na Invillinu: avtor jih sicer primerja s tipoma Isings 80 in 116 iz 2.–4. st. (Bierbrauer 1987, 283).

### 3.1.10 OSTALO

Ustje kozarca (*t.* 54: 4), najdeno v premešani plasti, je nenavadno nagubano, morda preoblikovano v ognju.

Sagui 1993, 130–131, Figs. 3, 9; Sternini 1995, 262). It seems that in the western Mediterranean they are not frequent enough to be appropriately typologically classified (overviews of D. Foy for southern France [1995] and S. Fünfschilling for Carthage [2006; 2010] practically do not mention any). Thus it is difficult to discern with individual pieces without good contexts whether these are remains from the earlier periods or do they belong to the Late Antiquity. At Tonovcov grad a few fragments of smaller bottles or balsamaria were found in a well defined stratigraphic context of phase LA 2 in the ecclesiastical complex (see chapter 3.3.3), therefore the same dating could be assumed for the fragment from building 1.

### 3.1.8 PLATE

A fragment of a plate foot (*Pl.* 58: 2) was found in a layer of phase LA 2. It can be assigned to type 10c according to D. Foy, which is dated to the late 5<sup>th</sup> and early 6<sup>th</sup> century according to the material from southern France (Foy 1995, 205). In Italy it appears also during the 6<sup>th</sup> and occasionally in the 7<sup>th</sup> century (Sagui 1993, Figs. 3, 6). Open forms of glass vessels (bowls and plates) are rare in the western part of the Mediterranean after the mid-5<sup>th</sup> century. In Slovenia the only analogy to the piece from Tonovcov grad was found at Fizine near Portorož (Gaspari et al. 2007, 178–179, Pl. 7: 209), in layers of the port complex which are dated from the second half of the 4<sup>th</sup> to the 6<sup>th</sup> century (Gaspari et al. 2007, 170; see chapter 3.7.7).

### 3.1.9 BOWLS

A tubular rim (*Pl.* 58: 6) was found in a layer from phases LA 1/2. It could belong among bowls with cylindrical walls and a tubular rim of type 2.5.1. according to I. Lazar, which are dated between the second half of the 1<sup>st</sup> and the 2<sup>nd</sup> century (Lazar 2003a, 80–81). This type of bowls is at Augst stratigraphically dated up until the 4<sup>th</sup> century (Type AR 109.1: Rütli 1991, 50). A similar rim was found in a church at Invillino which is dated between the 4<sup>th</sup> and the beginning of the 7<sup>th</sup> century (Bierbrauer 1988, 78, Fig. 23: 3). The rim could belong also to lamps with handles that frequently have tubular rims (Bierbrauer 1988, Fig. 23: 1,7,13–17). Two comparisons for the bowl from Tonovcov grad are found also among the material from Fizine near Portorož (Gaspari et al. 2007, Pl. 7: 202–203). These are defined as bowls with wide inverted rim folded outwards, such as in Italy are found in the 5<sup>th</sup> and 6<sup>th</sup> century (Gaspari et al. 2007, 179; Sternini 1995, 243; 2001, 25). It is difficult to decide where to place this piece solely on the basis of a small fragment and a small number of near analogies. Since it was found in a mixed layer it could belong to the time between the 4<sup>th</sup> and 6<sup>th</sup> century.



Odlomek ostenja posode (*t. 58: 8*) ima okras iz nataljenih belih niti, kar je značilno za konec 5. in začetek 6. st. (Foy 1995, 204), ne vemo pa, kakšni posodi je pripadal.

### 3.2 STAVBI 2 IN 3

Čeprav sta bili v uporabi v različnih časovnih obdobjih, sta stavbi 2 in 3 med seboj povezani, zato ju obravnavamo skupaj. Stavba 3 je bila v rabi v fazi PA 1, nato pa opuščena. V fazi PA 2 so na enega od zidov nekdanje stavbe 3 (zid 121) prislonili stavbo 2. Območje stavbe 3 pa je služilo za dvorišče oziroma gospodarski prostor (glej Tonovcov grad. Naselbinski ostanki in interpretacija, pogl. 2.4 in 3.2).

V plasti hodne površine stavbe 3 iz faze PA 1 sta bila najdena ustje in dno kozarca tipa Isings 106 (*t. 59: 2,9*). V gruščnati plasti nad hodno površino je bilo najdeno ustje kozarca (*t. 58: 20*).

V plasti iz faze PA 2 na dvorišču ob stavbi 2, to je na območju nekdanje stavbe 3, so bila najdena tri ustja (*t. 59: 1,4–5*) in noga kozarca tipa 1a (*t. 59: 7*) po V. Bierbrauerju (1987; glej pogl. 3.1.2). V to in spodnjo plast sta bila še v času faze PA 2 narejena dva vkopa. V vkopu SE 161 je bilo najdeno ustje (*t. 59: 3*), v vkopu SE 162 pa ustje (*t. 58: 21*).

V ruševinskih plasteh na dvorišču severno od stavbe 2 so bili najdeni dve ustji kozarcev tipa B (*t. 58: 19; 59: 6*), noga kozarca tipa 1a (*t. 59: 8*) in dva odlomka okenskega stekla.

V plasti faze PA 2 stavbe 2 so bili najdeni ročaj sveetilke (*t. 58: 18*) in dve nogi kozarcev tipov 1a (*t. 58: 14*) in 1b (*t. 58: 12*) po V. Bierbrauerju (1987; glej pogl. 3.1.2). V zgornji ruševinski plasti stavbe 2 so bili najdeni dve nogi kozarcev tipa 1b (*t. 58: 11,13*), ustje tipa B (*t. 58: 10*) po V. Bierbrauerju (1987; glej pogl. 3.1.2), dve nedoločljivi dni kozarcev brez noge (*t. 58: 16–17*) in del kozarca na nogi (*t. 58: 15*). Ustje kozarca (*t. 58: 9*) je naključna najdba.

### 3.3 SKLOP CERKVA

#### 3.3.1 SEVERNA CERKEV

V ruševinski plasti sta ležali dve ustji tipa B (*t. 59: 10,13*) po V. Bierbrauerju (1987; glej pogl. 3.1.2).

V narteksu severne in osrednje cerkve v plasti pod hodno površino so bili najdeni odlomek ustja kozarca brez noge (verjetno Isings 106), še en odlomek ustja kozarca in ena noga kozarca tipa 1a (*t. 59: 11–12,14*) po V. Bierbrauerju (1987; glej pogl. 3.1.2).

#### 3.3.2 OSREDNJA CERKEV

V osrednji cerkvi sta bila najdena dva skupka steklenih posod, oba v mešanici odpadlega ometa in ruševine.

A fragment of a rim (*Pl. 58: 7*) belongs to a bowl of type Foy 21a, which can be decorated with white threads and is dated to the end of the 5<sup>th</sup> and the beginning of the 6<sup>th</sup> century (Foy 1995, 205). It was found in a layer of phase LA 2. Such a bowl was also found in the settlement from the 5<sup>th</sup>-6<sup>th</sup> century at Monte Barro (Uboldi 1991, Pl. LV: 7). A great number of similar objects were found at Invillino but the author there compares them to types Isings 80 and 116, which belong to the 2<sup>nd</sup>-4<sup>th</sup> century (Bierbrauer 1987, 283).

#### 3.1.10 MISCELLANEOUS

A glass rim (*Pl. 54: 4*) found in a mixed layer is unusually folded, possibly altered in the fire.

A fragment of a vessel wall (*Pl. 58: 8*) bears the trailed decoration of white threads, which is characteristic for the end of the 5<sup>th</sup> and the beginning of the 6<sup>th</sup> century (Foy 1995, 204). We do not know to what kind of vessel it belonged.

### 3.2 BUILDINGS 2 AND 3

Despite the fact that they functioned in different periods buildings 2 and 3 are interconnected and will be discussed together. Building 3 was used during phase LA 1 and was later abandoned. In phase LA 2 building 2 was attached to one of the walls of building 3 (wall 121). The area of building 3 was then used as a courtyard (see Tonovcov grad. Settlement remains and interpretation, chapters 2.4 and 3.2).

In the walking surface of building 3 from phase LA 1 a rim and a base of a beaker of type Isings 106 (*Pl. 59: 2,9*) were found. In a gravel layer above the walking surface a glass rim of a beaker or goblet was found (*Pl. 58: 20*).

In a layer from phase LA 2 in the courtyard next to building 2, i.e. in the area of former building 3, three rims (*Pl. 59: 1,4-5*) and a goblet foot of type 1a (*Pl. 59: 7*) according to V. Bierbrauer (1987; see chapter 3.1.2) were found. Into this layer and the one underneath two pits were dug during the time of phase LA 2. A rim (*Pl. 59: 3*) was found in pit SU 161 and a rim (*Pl. 58: 21*) in pit SU 162.

In the destruction layers in the courtyard north of building 2 two goblet rims of type B (*Pls. 58: 19; 59: 6*), a goblet foot of type 1a (*Pl. 59: 8*), and two fragments of window glass were found.

In a layer of phase LA 2 in the building 2 a lamp handle (*Pl. 58: 18*) and two stemmed goblet feet of types 1a (*Pl. 58: 14*) and 1b (*Pl. 58: 12*) according to V. Bierbrauer (1987; see chapter 3.1.2) were found. In the upper destruction layer of building 2 two stemmed goblet feet of type 1b (*Pl. 58: 11,13*), a rim of type B (*Pl.*

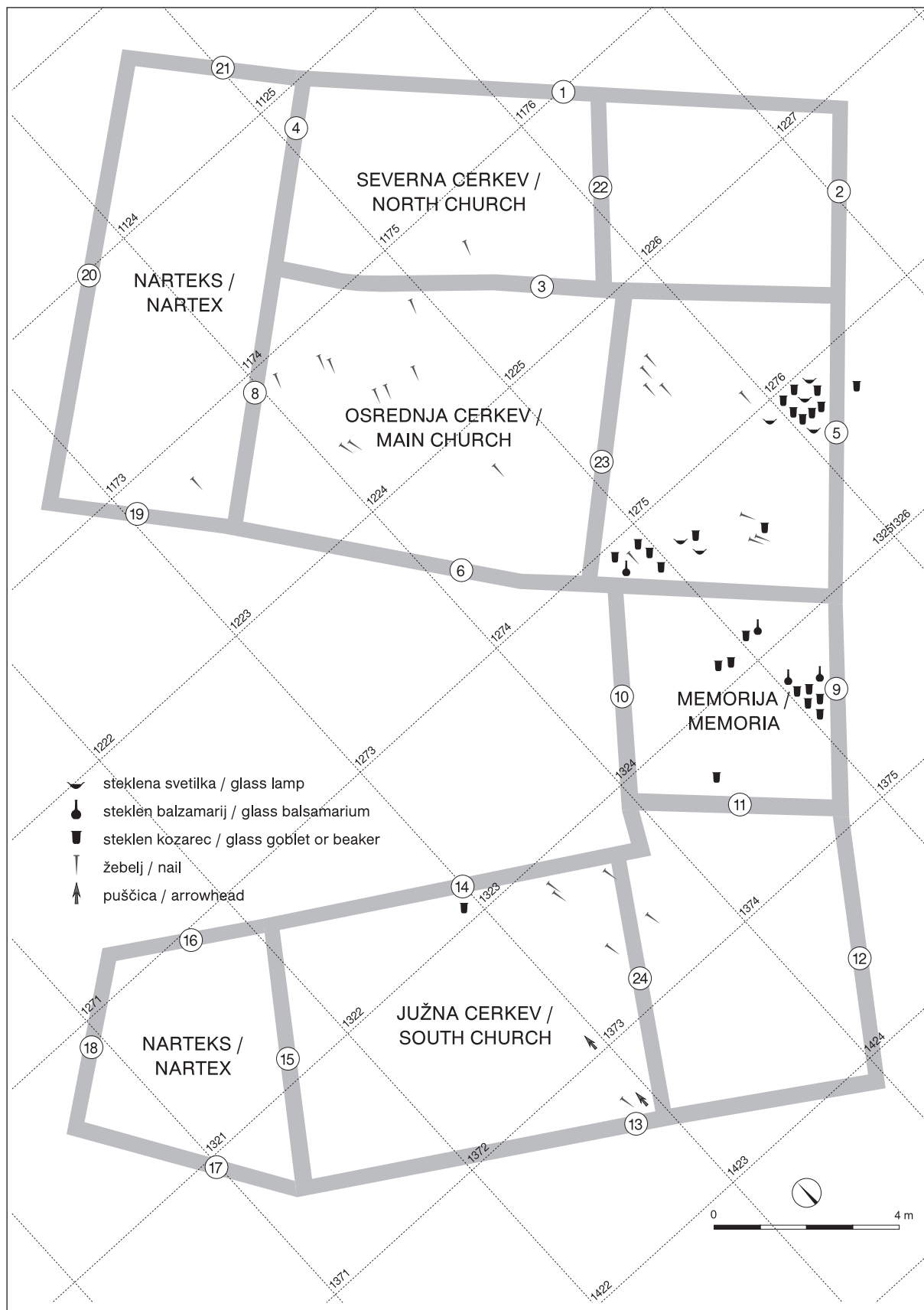

Sl. 3.2: Karta razprostranjenosti steklenih posod, žebeljev in pušičinih osti v cerkvenem sklopu (hodne površine faze PA 2).  
 Fig. 3.2: Distribution of glass vessels, nails and arrowheads in the ecclesiastical complex (walking surfaces of phase LA 2).

Prvi skupek odlomkov ustij (*t. 59: 15–16,18,22*), vbočenih dnov (*t. 60: 2,5–6*) in delov svetilk (*t. 60: 8,10–12*) je ležal na skalni polici med krakom klopi za duhovščino in zidom 5. Drugi skupek ustij (*t. 59: 17,19,22*) in dnov (*t. 60: 1,3–4*) ter ustje manjše stekleničke ali balzamarija (*t. 60: 14*) so bili blizu prehoda v “memorijo” (*sl. 3.2*).

V ruševini je bilo najdeno stekleno ustje (*t. 59: 21*), eno ustje manjše posodice pa ni natančneje umeščeno znotraj prezbiterija (*t. 60: 15*).

Vsa ustja pripadajo tipu B po Bierbrauerju (1987; glej pogl. 3.1.2), eno je nedoločljivo (*t. 59: 17*). Vse svetilke pripadajo tipu I.1 po M. Uboldi (Uboldi 1995, sl. 2; glej pogl. 3.1.6).

Štiri dna kozarcev brez noge pripadajo tipu Isings 109 (*t. 60: 2,4–6*) in dva tipu Isings 106 (*t. 60: 1,3*).

### 3.3.3 “MEMORIJA”

Dve ustji kozarcev (*t. 60: 16–17*), dve ustji manjših posodic ali balzamarijev in dno balzamarija (*t. 61: 6–7,9*), dno kozarca (*t. 61: 3*) in vrat steklenice ali stekleničke (*t. 61: 5*) so ležali v kulturni plasti ob vzhodnem zidu prostora (zid 9; *sl. 3.2*).

V ruševinski plasti nad kulturno so bili sredi prostora najdeni še noga in dno steklenih kozarcev (*t. 60: 18; 61: 2*), dno kozarca Isings 109 (*t. 61: 4*), dno balzamarija (*t. 61: 8*) in verjetno še eno dno kozarca (*t. 61: 1*).

Manjši ustji (*t. 61: 6–7*) sta lahko pripadali večjima balzamarijema ali manjšima stekleničkama, predvidoma z vbočenim dnom, k eni od njiju zelo verjetno spada tudi vrat (*t. 61: 5*). Obe dni balzamarijev (*t. 61: 8–9*) spadata po obliki v tip 8.6.4. po I. Lazar, to je med balzamarije s podolgovatim ovalno oblikovanim trupom, ki so datirani v drugo polovico 1. oz. prvo polovico 2. st. (Lazar 2003a, 180). Glede na to, da se balzamariji pojavljajo tudi v poznoantičnem obdobju in da so tukaj najdeni v dobro umeščenem kontekstu, je verjetneje, da najdbi pripadata fazi PA 2 in nista starejši (glej pogl. 3.1.7).

### 3.3.4 JUŽNA CERKEV

V južni cerkvi je bil v ruševinski plasti najden le odlomek dna steklenice (*t. 61: 10*), ki najverjetneje pripada nizki kvadratni steklenici z ročajem (Isings 50a), kakršne so datirane med drugo polovico 1. in 2. st. (Lazar 2003a, 149), in verjetno nima zveze s cerkvijo.

### 3.3.5 PROSTOR MED OSREDNJO IN JUŽNO CERKVIJO

V izmenjavajočih se gruščnatih in maltnih plasteh skalnatega prostora med osrednjo in južno cerkvijo je bilo najdenih 22 opredeljivih ustij kozarcev, od tega

58: 10) according to V. Bierbrauer (1987; see chapter 3.1.2), two indefinable bases of beakers (*Pl. 58: 16–17*), and a part of a stemmed goblet (*Pl. 58: 15*) were found. Beaker or goblet rim (*Pl. 58: 9*) is a chance find.

## 3.3 ECCLESIASTICAL COMPLEX

### 3.3.1 NORTH CHURCH

Two rims of type B (*Pl. 59: 10,13*) according to V. Bierbrauer (1987; see chapter 3.1.2) were lying in the destruction layer.

A fragment of a beaker rim (probably Isings 106), another fragment of a goblet or beaker rim, and a goblet foot of type 1a (*Pl. 59: 11–12,14*) according to V. Bierbrauer (1987; see chapter 3.1.2) were found in the narthex of the north and main church in a layer under the walking surface.

### 3.3.2 MAIN CHURCH

In the main church, two clusters of glass vessels were found, both in the mixture of the fallen-off plaster and the destruction layer. The first cluster of rim fragments (*Pl. 59: 15–16,18,22*), concave bases (*Pl. 60: 2,5–6*), and lamp fragments (*Pl. 60: 8,10–12*) was lying on the rock shelf between the clergy bank and wall 5. The other cluster of rims (*Pl. 59: 17,19,22*), bases (*Pl. 60: 1,3–4*), and a rim of a smaller bottle or a balsamarium (*Pl. 60: 14*) lay near the passage into the ‘memoria’ (*Fig. 3.2*).

In the destruction layer a beaker or goblet rim was found (*Pl. 59: 21*), while one rim of a smaller vessel is not precisely located within the presbytery (*Pl. 60: 15*).

All rims belong to type B according to Bierbrauer (1987; see chapter 3.1.2) only one is indefinable (*Pl. 59: 17*). All lamps belong to type I.1 according to M. Uboldi (Uboldi 1995, Fig. 2; see chapter 3.1.6).

Four beaker bases belong to type Isings 109 (*Pl. 60: 2,4–6*) and two to type Isings 106 (*Pl. 60: 1,3*).

### 3.3.3 ‘MEMORIA’

Two goblet or beaker rims (*Pl. 60: 16–17*), two rims of smaller vessels or balsamaria and a base of a balsamarium (*Pl. 61: 6–7,9*), a glass base (*Pl. 61: 3*), and a bottle or a small bottle neck (*Pl. 61: 5*) were all lying in the cultural layer along the eastern wall of the room (wall 9; *Fig. 3.2*).

The destruction layer above the cultural one in the middle of the room revealed also a goblet foot and a beaker base (*Pls. 60: 18; 61: 2*), a base of a beaker Isings 109 (*Pl. 61: 4*), a base of a balsamarium (*Pl. 61: 8*), and probably also a beaker base (*Pl. 61: 1*).

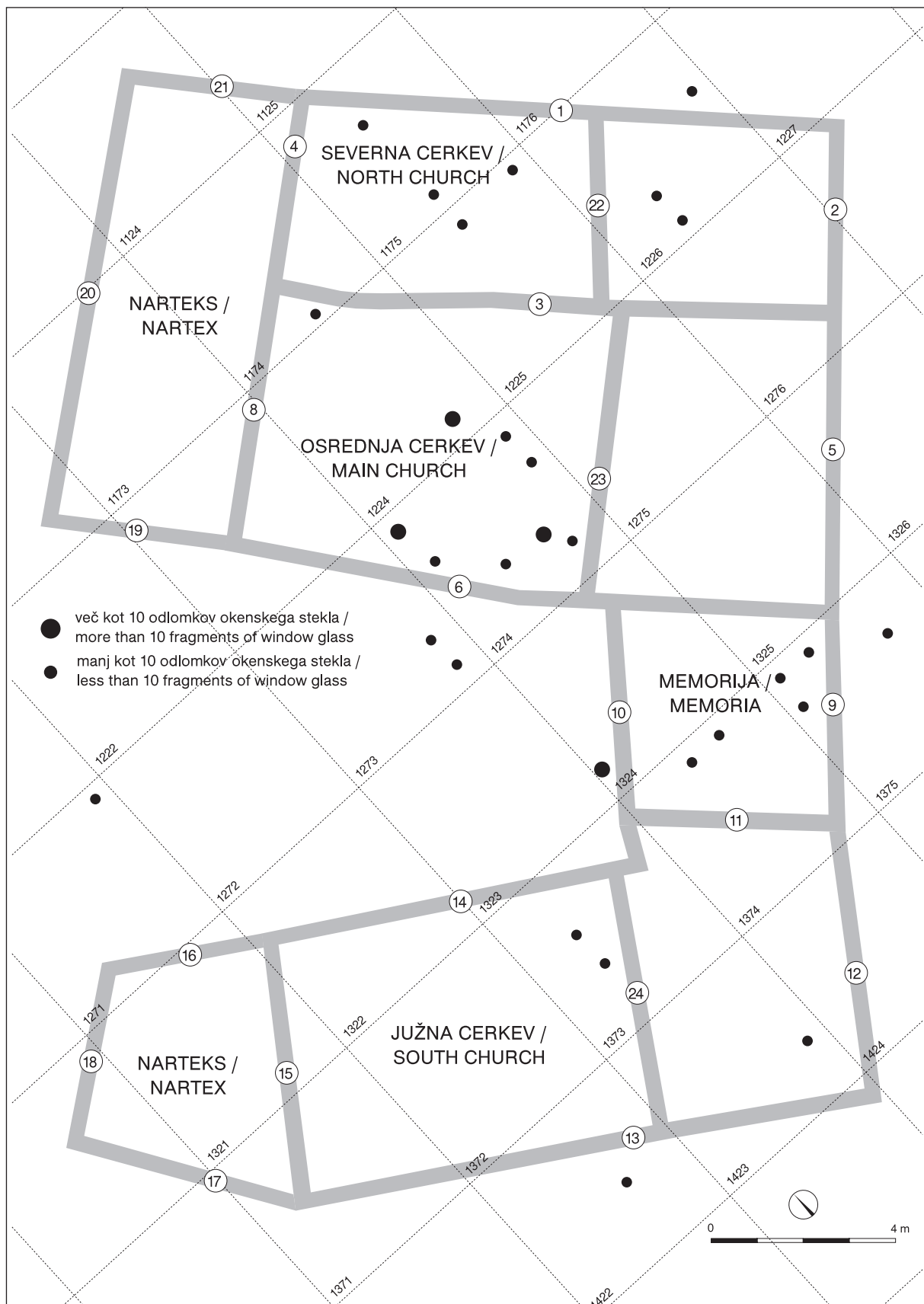

Sl. 3.3: Karta razprostranjenosti okenskega stekla v cerkvenem sklopu.

Fig. 3.3: Distribution of window glass in the ecclesiastical complex.

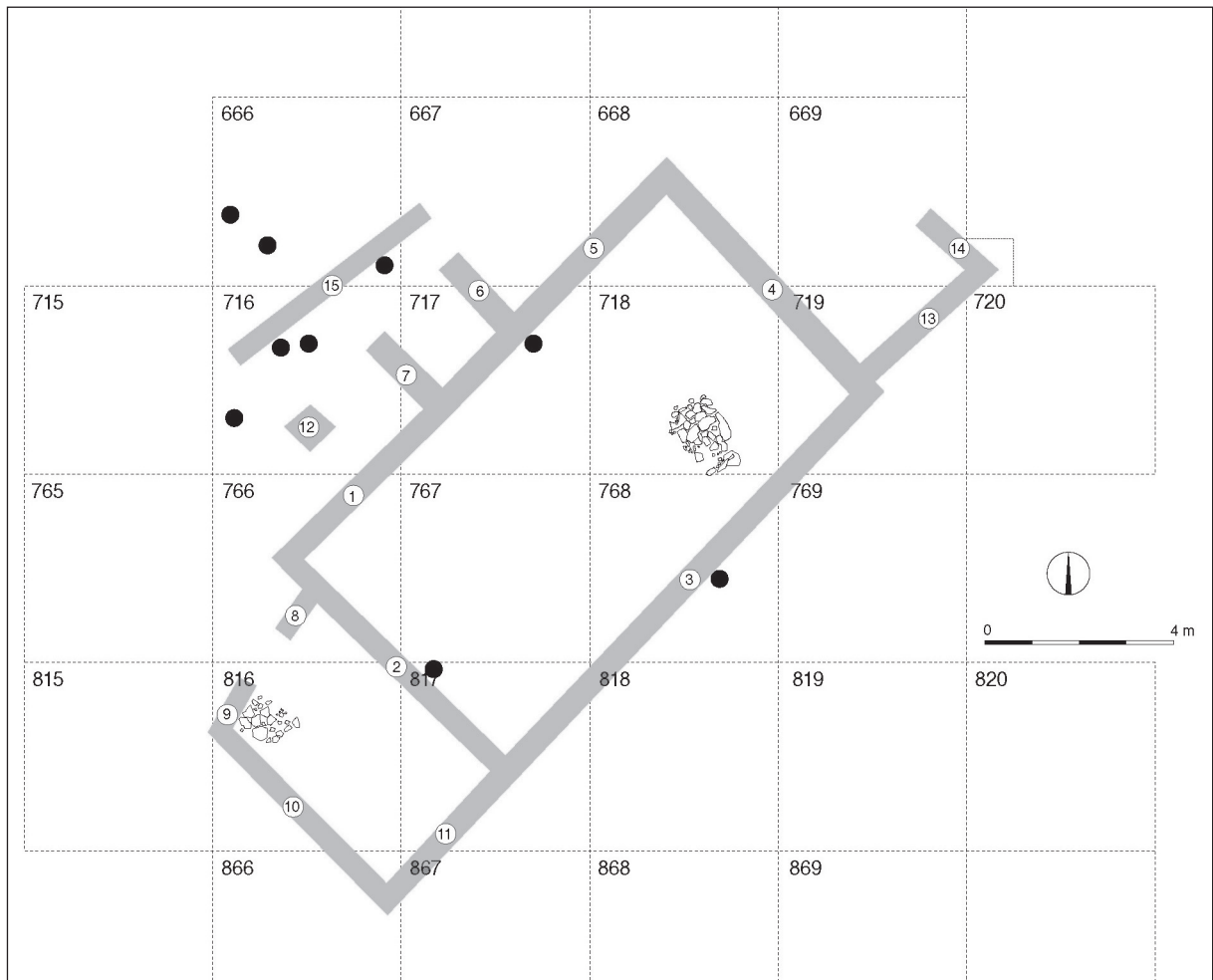

Sl. 3.4: Karta razprostranjenosti okenskega stekla na območju stavbe 1.  
 Fig. 3.4: Distribution of window glass in and around building 1.

18 tipa B (cilindrična oblika: *t. 61*: 17–18, 22–23; *62*: 1–5, 7–14) in 4 tipa C (konična oblika: *t. 61*: 19, 21; *62*: 6, 15). Najdeni sta bili tudi dve nogi kozarca tipa 1a (močno izbočena stojna ploskev: *t. 63*: 4–5) in dve nogi tipa 1b (položna stojna ploskev z izrazitim robom: *t. 63*: 2–3). 10 odlomkov ustij (*t. 62*: 16–25) je premajhnih za opredelitev (vse po Bierbrauer 1987; glej pogl. 3.1.2).

Najdena so bila tudi tri dna, dve tipa Isings 106 (*t. 63*: 6–7) in eno tipa Isings 109 (*t. 63*: 8), ter eno odrezano ustje (*t. 61*: 20) kozarca brez noge. Osem odlomkov dnov je slabo ohranjenih, zato lahko rečemo le, da najverjetneje pripadajo tipoma Isings 106 ali 109 (*t. 63*: 9–16).

Najdeni so bili odlomki steklenih svetilk: ustje (*t. 63*: 24), ustje in ročaj (*t. 63*: 22–23), dva ročaja (*t. 63*: 20, 25) in ustje z nastavkom ročaja (*t. 63*: 19) tipa I.1 po M. Uboldi (glej pogl. 3.1.6).

Dve debelejši vbočni dni večjega premera, ki sta ležali v SE 92, pripadata steklenicama (*t. 63*: 17–18). Odlomka sta premajhna, da bi steklenici lahko natančneje opredelili, vendar glede na to, da kažeta bolj cilindrično

Two smaller rims (*Pl. 61*: 6–7) could have belonged to bigger balsamaria or smaller bottles, supposedly with a concave base, the neck (*Pl. 61*: 5) most probably also belongs to one of these two. Both balsamaria bases (*Pl. 61*: 8–9) belong, according to shape, to type 8.6.4. according to I. Lazar, among balsamaria with an elongated oval body, which are dated to the second half of the 1<sup>st</sup>-first half of the 2<sup>nd</sup> century (Lazar 2003a, 180). Considering the fact that balsamaria also appear in the Late Antique period and that they are found here in a well set context, it is more probable that they belong to phase LA 2 and are not older finds (see chapter 3.1.7).

### 3.3.4 SOUTH CHURCH

In the south church only a fragment of a bottle base (*Pl. 61*: 10) was found in the destruction layer and it most probably belongs to a low square bottle with a handle (Isings 50a), such as are dated between the second half

kot kroglasto obliko, najverjetneje pripadata tipu Isings 132 (glej pogl. 3.1.5).

Eno ustje (*t. 63: 27*) pripada plitvi polkroglasti skodelici tipa 2.6.4. po I. Lazar (Isings 116), ki je datirana v čas med prvo polovico 4. in prvo polovico 5. st. (Lazar 2003a, 85). Najdena je bila v plasti SE 89.

Noga kozarca na nizki nogi tipa Foy 19 (Foy 1995, 202) iz 5. st. je bila najdena v SE 111 (*t. 63: 26*). Enaka noga (*t. 58: 4*) je bila najdena zunaj stavbe 1 na hodni površini (SE 24) ter na tlaku stranskega prostora cerkve na Invillinu (Bierbrauer 1988, sl. 23: 5; glej pogl. 3.1.3).

### 3.3.6 GROBOVI

Nekaj odlomkov steklenih posod je bilo najdenih v zasutih grobov, ki sicer niso vsebovali pridatkov (za opis grobov glej Tonovcov grad. Naselbinski ostanki in interpretacija, pogl. 2.5).

Odlomek svetilke (*t. 61: 12*) in ustje (*t. 61: 11*) sta bila najdena v zasutju groba 1.

Stekleno ustje kozarca je ležalo v zasutju groba 7 (*t. 61: 13*).

Dve ustji (*t. 61: 14–15*) in dno kozarca (*t. 61: 16*) so bili najdeni v zasutju groba 21.

## 3.4 VODNI ZBIRALNIK

Najdeni so bili slabo ohranjen odlomek dna kozarca brez noge (*t. 63: 29*), noga kozarca tipa 1b (*t. 63: 28*) (po Bierbrauer 1987, glej pogl. 3.1.2) in ustje majhne steklene posodice (*t. 63: 30*). Premer posodice je prevelik za balzamarij, tako da je ustje verjetno pripadalo manjši steklenički.

Večina najdb je bila najdenih v ruševini. Ustje manjše posodice (*t. 63: 30*) je bilo najdeno v plasti tik nad prazgodovinsko, v katero je vkopana cisterna, noga kozarca (*t. 63: 28*) pa je ležala v plasti pod zunanjim zidom cisterne, kar prav tako kaže na čas pred gradnjo objekta, ki je datirana v začetek ali sredino 6. st.

## 3.5 OKENSKO STEKLO

Odlomki okenskega stekla z območja stavbe 1 se prostorsko bolj navezujejo na ostanke zidov (zid 15) stavbe, ki je tam stala v fazi PA 1 (*sl. 3.4*), kot pa na samo stavbo 1.

Majhno število najdenih odlomkov okenskega stekla pri stavbah 2 in 3 ne kaže na obstoj zasteklitve, ampak je steklo verjetno zdrselo s cerkvenega platoja.

Količina najdenih odlomkov okenskega stekla v cerkvah in njihovi okolici kaže, da so bila zastekljena le okna cerkva (*sl. 3.3*). Razprostranjenost nakazuje okenske odprtine v severni steni ladje in prezbiterija severne

of the 1<sup>st</sup> and the 2<sup>nd</sup> century (Lazar 2003a, 149), and is probably not connected with the church.

### 3.3.5 AREA BETWEEN THE MAIN AND THE SOUTH CHURCH

In the alternating gravel and mortar layers of the rocky space between the main and the south church 22 definable glass rims were found, 18 of these are of type B (cylindrical form: *Pls. 61: 17-18, 22-23; 62: 1-5, 7-14*) and 4 of type C (conical form: *Pls. 61: 19, 21; 62: 6, 15*). Two goblet feet of type 1a (strongly convex foot: *Pl. 63: 4-5*) and two feet of type 1b (slightly convex foot with a marked ring: *Pl. 63: 2-3*) were also found. 10 rim fragments (*Pl. 62: 16-25*) are too small to define (all according to Bierbrauer 1987; see chapter 3.1.2).

Three beaker bases were also discovered, of which two are of type Isings 106 (*Pl. 63: 6-7*) and one of type Isings 109 (*Pl. 63: 8*), and one cut rim (*Pl. 61: 20*) of a beaker. Eight base fragments are quite poorly preserved thus we can only state that they most probably belong to beakers types Isings 106 or 109 (*Pl. 63: 9-16*).

Fragments of glass lamps were found: a rim (*Pl. 63: 24*), a rim and a handle (*Pl. 63: 22-23*), two handles (*Pl. 63: 20, 25*), and a rim with a part of a handle (*Pl. 63: 19*) of type I.1 according to M. Ubaldi (see chapter 3.1.6).

Two thicker concave bases of larger diameter, which lay in SU 92, belong to two bottles (*Pl. 63: 17, 18*). The fragments are too small to enable the detailed classification of bottles but considering the fact that they display a more cylindrical rather than globular shape they probably belong to type Isings 132 (see chapter 3.1.5).

One rim (*Pl. 63: 27*) belongs among shallow hemispherical bowls of type 2.6.4. according to I. Lazar (Isings 116), dated to the time between the first half of the 4<sup>th</sup> and the first half of the 5<sup>th</sup> century (Lazar 2003a, 85). It was found in layer SU 89.

A foot of footed beaker of type Foy 19 (Foy 1995, 202) from the 5<sup>th</sup> century was found in SU 111 (*Pl. 63: 26*). Similar feet were discovered outside building 1 in the walking surface (*Pl. 58: 4; SU 24*) and on the mortar floor of the eastern annex of the church at Invillino (Bierbrauer 1988, Fig. 23: 5; see chapter 3.1.3).

### 3.3.6 GRAVES

A few fragments of glass vessels were found in the fills of graves which otherwise did not contain any grave goods (for the description of the graves see Tonovcov grad. Settlement remains and interpretation, chapter 2.5).

A fragment of a lamp (*Pl. 61: 12*) and a goblet or beaker rim (*Pl. 61: 11*) were found in the fill of grave 1.

A beaker or goblet rim lay in the fill of grave 7 (*Pl. 61: 13*).

cerkve (zid 1), na stenah osrednje in južne cerkve, ki gledata na dvorišče (zidova 6 in 14), najverjetneje na vzhodni in zahodni steni "memorije" (zidova 9 in 10) in (v prezbiterialnem delu) na južni steni južne cerkve (zid 13). Zid 13 stoji nad prepadno steno, tako da je nekaj okenskega stekla zelo verjetno zdrselo po pobočju. Presenetljivo stekla ni najdenega v prezbiteriju osrednje cerkve, kjer bi ga najbolj pričakovali. Morda so ta del cerkve razsvetljevale le steklene svetilke (glej pogl. 3.3.2).

Okensko steklo na Tonovcovem gradu je izdelano s cilindrično tehniko, ki jo lahko prepoznamo po vrstah razpotegnjenih zračnih mehurčkov v masi. Okenske plošče so v tej tehniki naredili tako, da so napihano steklo oblikovali v cilindre, nato pa jih prerezali in poravnali v pravokotnike (O'Hea 2007, 234; Kanyak 2009, 38–39; glej tudi pogl. 3.7.9).

### 3.6 SKLEP

V zaključenih sklopih prve poznoantične faze (PA 1; druga polovica 4. in začetek 5. st.) v stavbi 1, ki jih sicer ni veliko, je bilo najdenih le nekaj posameznih vbočenih dnov kozarcev brez noge in ostenje steklenice (t. 57: 1–2,4,15–16). Tudi v stavbi 3, ki spada v fazo PA 1, je bilo najdenih zelo malo odlomkov stekla (t. 59: 2,9). Faza PA 1 je na Tonovcovem gradu z drugim gradivom sicer dobro zastopana, zato preseneča majhno število značilnega steklenega posodja. Morda pomanjkanje steklenih najdb v drugi polovici 4. in začetku 5. st. kaže na drugačno oskrbovanje postojanke na Tonovcovem gradu v primerjavi z drugimi utrdkami na območju alpskih zapor, kjer je steklo pogostejše (Hrušica: Ulbert 1981, t. 49; Martinj hrib: Leben, Šubic 1990, t. 5–9).

Stekleno posodje je bilo na Tonovcovem gradu najdeno v veliki večini le v plasteh druge poznoantične faze (PA 2; konec 5.–začetek 7. st.) v stavbi 1, kjer so uporabljali predvsem kozarce na visoki nogi in kozarce z vbočenim dnom (t. 54: 6–26; 55: 1–27; 56: 1–36; 57: 1–12). V majhnih količinah so zastopani tudi drugi tipi posodja, na primer kozarci na nizki nogi, steklenice, svetilke, manjša steklenička in krožnik (t. 57: 13–14,17–22; 58: 1–8). Nekateri kosi so slabo ohranjeni in težko natančno določljivi, zato bi lahko spadali tudi med najdbe iz starejše stavbe iz faze PA 1. Najdenih je bilo le nekaj odlomkov okenskega stekla, zato menimo, da stavba v fazi PA 2 ni bila zastekljena (sl. 3.4).

Redki ostanki steklenih posod (t. 58: 9–18) ne pripomorejo k interpretaciji dogajanja v stavbi 2 v času faze PA 2. Stavba glede na odsotnost ognjišča verjetno ni bila bivalnega značaja. Odlomki stekla iz ruševinskih plasti verjetno izvirajo iz ruševine višje ležečega cerkvenega sklopa, kjer pa je bilo najdenih precej več steklenih posod.

Skupek stekla za klopjo za duhovščino v osrednji cerkvi (t. 59: 15–16,18,22; 60: 2,5–6,8,10,12; sl. 3.2) lahko

Two goblet or beaker rims (*Pl. 61: 14-15*) and a beaker base (*Pl. 61: 16*) were discovered in the fill of grave 21.

### 3.4 WATER CISTERN

A poorly preserved base of a beaker (*Pl. 63: 29*), a goblet foot of type 1b (*Pl. 63: 28*) (according to V. Bierbrauer 1987, see chapter 3.1.2), and a rim of a small glass vessel (*Pl. 63: 30*) were found. The diameter of the vessel is too big for a balsamarium thus it is probably a part of a smaller bottle.

The majority of finds was discovered in the destruction layer. The rim of a smaller vessel (*Pl. 63: 30*) was found in a layer immediately above the prehistorical one into which the cistern is dug, while the beaker base (*Pl. 63: 28*) lay in the layer beneath the outer wall of the cistern, which also points to the time before the construction of the building dated to the beginning or the middle of the 6<sup>th</sup> century.

### 3.5 WINDOW GLASS

Fragments of window glass from the area of building 1 spatially relate more to the remains of walls (wall 15) of the building which stood there during phase LA 1 (*Fig. 3.4*) than to building 1 itself.

The small number of found window glass fragments near buildings 2 and 3 does not indicate the existence of glazing but the glass most probably slid from the church plateau.

The amount of found window glass fragments in the churches and their surrounding suggests that only the church windows were glazed (*Fig. 3.3*). The distribution indicates openings in the northern wall of the nave and presbytery of the north church (wall 1), on both walls of the main and south church which face the space in-between (walls 6 and 14), most probably on the eastern and western wall of the 'memoria' (walls 9 and 10), and (in the presbytery part) at the southern wall of the south church (wall 13). Wall 13 stands over the precipitous rock hence some of the window glass must have slid down the slope. Surprisingly, no glass was found in the presbytery of the main church where we would most expect it. Possibly this part of the church was illuminated solely by glass lamps (see chapter 3.3.2; *Fig. 3.2*).

Window glass at Tonovcov grad is made by the cylinder technique which can be recognised by parallel rows of elongated air bubbles in the mass. Window panes in this technique were made by shaping the blown glass into cylinders, then cutting it and straightening it into rectangles (O'Hea 2007, 234; Kanyak 2009, 38–39; see also chapter 3.7.9).

kaže na prostor, kjer so kozarce in svetilke shranjevali, lahko pa so bile svetilke nad klopjo obešene ali postavljene, da so razsvetljevale najsvetejši del prezbitarija. Zanimivo je, da so vse svetilke najdene prav v prostoru, kjer ni okenskega stekla – torej v prostoru brez oken. To še dodatno dokazuje uporabo in originalno mesto svetilk v prezbitariju osrednje cerkve.

Manj pričakovan je pojav drugega skupka predmetov ob prehodu iz osrednje cerkve v “memorijo” (t. 59: 17,19,22; 60: 1,3,4,14). Skupek je vseboval kozarce, svetilke in manjšo stekleničko.

Glede na lepo izdelan arhitrav nad prehodom je bila “memorija” očitno pomemben del cerkvenega sklopa. V njej je bilo najdenih nekaj kozarcev in balzamarijev ali majhnih stekleničk (sl. 3.2). V njih so verjetno hranili pomembne tekočine za cerkvene obrede (olje, vino, vodo) ali celo relikvije. Svetilk v tem prostoru ni bilo.

Razprostranjenost okenskega stekla v cerkvenem sklopu (sl. 3.3) kaže na zasteklitev cerkvenih ladij in “memorije”.

V cerkvah na Tonovcovem gradu se pojavlja podoben sestav steklenih posod – svetilke, kozarci, steklenice in manjše stekleničke – kot v nekaterih velikih poznoantičnih cerkvah; takšni sta na primer bazilika v grškem mestu Phillipi (Antonaras 2007, 51–54, sl. 5) ali cerkev sv. Ciprijana pri Omišu na Hrvaškem (Fadić 1994).

Funkcije vmesnega prostora med cerkvami ne moremo dokončno pojasniti, prav tako ne plasti, ki so bile v njem (glej Tonovcov grad. Naselbinski ostanki in interpretacija, pogl. 3.3.4). Steklene najdbe so bile prisotne vse od skalnega dna do zgornje ruševine in so bile razporejene po izmenjavajočih se gruščnatih in maltnih plasteh. Tipi posod, kozarci, steklenice, svetilke (t. 61: 17–23; 62: 1–25; 63: 1–27), kažejo na časovno in vsebinsko podobnost s cerkvami, ki se dvigajo nad prostorom. Verjetno je, da so tako plasti kot najdbe v vmesnem prostoru povezane s postopnim propadanjem cerkvenih zgradb.

Steklene najdbe s Tonovcovega gradu se torej lepo vključujejo v podobo steklenih izdelkov v poznoantičnem Sredozemlju in njegovem neposrednem zaledju. Med najbolj uporabljano posodje spadajo tudi tu kozarci na visoki nogi, ki so najznačilnejši predstavnik sredozemskega steklarstva od konca 5. st. dalje in predvsem v 6. in 7. st. (Sagui 1993, 129; Foy 1995, 207–209; Sternini 1995, 259; Whitehouse 1999; Lafli, Gürlér 2010, 434). Skupaj s kozarci brez noge in steklenicami sestavljajo pivski komplet, ki je poleg steklenih svetilk edino posodje, ki je bilo v pozni antiki še razmeroma pogosto izdelano iz stekla (glej pogl. 3.7).

### 3.6 CONCLUSION

In the closed contexts of the first Late Antique phase (LA 1; the second half of the 4<sup>th</sup> and the beginning of the 5<sup>th</sup> century) in building 1, which are not many, only a few individual concave beaker bases and a bottle wall (Pl. 57: 1-2,4,15-16) were found. Very few glass fragments (Pl. 59: 2,9) were found also in building 3, which belongs to phase LA 1. Phase LA 1 is at Tonovcov grad generally well represented by other material thus we were surprised by the small number of typical glass vessels. The lack of glass finds in the second half of the 4<sup>th</sup> and beginning of the 5<sup>th</sup> century could indicate a different supply system of the post at Tonovcov grad in comparison to other forts in the area of Claustra where glass is more frequent (Hrušica: Ulbert 1981, Pl. 49; Martinj hrib: Leben, Šubic 1990, Pls. 5-9).

Glass vessels were at Tonovcov grad mostly found in layers of the second Late Antique phase (LA 2; end of the 5<sup>th</sup>-beginning of the 7<sup>th</sup> century) in building 1, where primarily stemmed goblets and beakers with a concave base were used (Pls. 54: 6-26; 55: 1-27; 56: 1-36; 57: 1-12). Other types of vessels are represented in small numbers, e.g. footed beakers, bottles, lamps, a small bottle and plate (Pls. 57: 13-14,17-22; 58: 1-8). Some pieces are poorly preserved and are difficult to classify thus these could belong among finds from the older building from phase LA 1. Only a few fragments of window glass were found hence we believe that the building was not glazed during phase LA 2 (Fig. 3.4).

Rare remains of glass vessels (Pl. 58: 9-18) do not contribute to the interpretation of events in building 2 during phase LA 2, which was due to the absence of a fireplace not intended for dwelling. Glass fragments from the destruction layers above the building probably originate in the destruction layer of the higher located ecclesiastical complex where many more glass vessels were found.

The cluster of glass behind the clergy bank in the main church (Pls. 59: 15-16,18,22; 60: 2,5-6,8,10-12; Fig. 3.2) could indicate the area where glasses and lamps were kept, but it could also be that lamps were hung or set above the bank to illuminate the holiest part of the presbytery. It is interesting that all lamps were found in the room without any window glass – thus in the room without windows. This additionally proves the use and original location of lamps in the presbytery of the main church.

Less expected was the occurrence of the second cluster of objects along the passage from the main church into ‘memoria’ (Pls. 59: 17,19,22; 60: 1,3,4,14). The cluster included beakers, lamps, and a smaller bottle.

Considering the beautifully made architrave above the passage, ‘memoria’ was obviously an important part of the ecclesiastical complex. A few beakers and balsamaria or small bottles (Fig. 3.2) were found in it. In these vessels important fluids for church ceremonies



### 3.7 POZNOANTIČNO STEKLO V SLOVENIJI

#### 3.7.1 IZHODIŠČE

Potem ko je v zgodnjem rimskem obdobju (sekundarna) proizvodnja steklenih posod v vzhodnem delu imperija v količinah in kakovosti zaostajala za Italijo, se je v 4. in zgodnjem 5. stoletju razcvetela. Ta razcvet povezujejo z ekonomskim in kulturnim razvojem Palestine po Konstantinovi graditveni usmeritvi v Sveto deželo po letu 324 in po odpravi davkov za nekatere obrtnike, med njimi za steklarje, leta 337 (Stern 1999, 481–484).

Med 5. in 8. st. je bilo steklo vedno pogosteje reciklirano in posledično vedno slabše kakovosti. V vzhodnem Sredozemlju so izboljševali predelano steklo z dodajanjem alkalnih snovi, v zahodnem delu pa to ni bilo mogoče, saj niso bile na voljo (Dussart et al. 2004, 80–82).

Tudi barva stekla (naravno obarvano) se je v poznoantičnem obdobju spreminjala. V 4. st. je steklo večinoma še brezbarvno ali rahlo modrikasto do zelenkasto. V prvih dveh tretjinah 5. st. barva preide v temnejše odtenke, predvsem v olivno in temno zeleno. Za prvo tretjino 6. st. sta značilna zelenkasta barva (odtenek *vert d'eau*, *aqua* oz. vodno zelena) in okras iz nataljenih belih niti, steklo pa je zelo tanko. Od sredine 6. st. naprej se poleg zelene pogosto pojavljajo tudi rumenkasti odtenki, steklo pa je debelejše in bolj odporno (Foy et al. 2003, 41–42). V vzhodnem delu imperija na nekaterih najdiščih iz bizantinskega obdobja prevladujejo modrozeleni in zeleni odtenki (npr. Gerasa/Jerash, Sarde: Meyer 1988, 217). V drugi polovici 7. ter v 8. st. se v zahodnem Sredozemlju pojavi in močno prevlada svetlomodro steklo (Foy et al. 2003, 41–42).

Izdelava steklene mase se kot posledica širitve Arabcev in političnih sprememb v Egiptu spremeni okoli sredine 9. st. (Dussart et al. 2004, 76–77). V vzhodnem Sredozemlju namesto natrona začnejo uporabljati pepel halofitov (obmorskih rastlin), v zahodnem delu pa pepel drugih rastlin. Stara in nova receptura sta sicer precej dolgo obstajali vzporedno. V Evropi (današnje Francija, Anglija, Italija) so izdelovali kakovostno steklo po rimski recepturi z natronom še v 12. stoletju (Uboldi, Verità 2003, 130–132).

Raziskave poznoantičnega stekla so dolgo zaostajale za raziskavami rimskega stekla. Prve klasifikacije steklenega gradiva z velikih najdišč vzhodnega Sredozemlja (Crowfoot, Harden 1931; Harden 1936; Saldern 1962 itd.) se zlagoma preverjajo in prilagajajo novim datacijam samih najdišč (Saguì 1993, 129; Whitehouse 1999), mnogo stekla pa ostaja še neobdelanega (pregleda stanja raziskav npr. Lauwers et al. 2007; Lafli, Gürler 2010). Precej živahneje se je v zadnjih desetletjih raziskovanje stekla odvijalo v zahodnem Sredozemlju

(oil, wine, water) or even relics were probably kept. There were no lamps in this room.

Distribution of window glass in the ecclesiastical complex (Fig. 3.3) indicates the glazing of church naves and 'memoria'.

Churches at Tonovcov grad reveal a similar composition of glass vessels – lamps, beakers, goblets, bottles, and smaller bottles – as some great Late Antique churches, for example the basilica from the Greek town Phillipi (Antonaras 2007, 51–54, Fig. 5) or the church of Sv. Ciprijan near Omiš in Croatia (Fadić 1994).

The function of the space between churches cannot be conclusively explained, the same goes for the layers located within it (see Tonovcov grad. Settlement remains and interpretation, chapter 3.3.4). Glass finds were present from the rocky bottom to the upper destruction layer and were distributed over the alternating gravel and mortar layers. Vessel types, goblets, beakers, bottles and lamps (Pls. 61: 17–23; 62: 1–25; 63: 1–27) reveal the chronological and contextual similarity to churches rising above this space. It is probable that both, layers and finds of the space between the main and the south church, are connected to the gradual decay of ecclesiastical buildings.

Glass finds from Tonovcov grad therefore nicely fit into the picture of glass objects in Late Antique Mediterranean and its immediate hinterland. There also stemmed goblets are among the most widely used vessels and the most typical representatives of Mediterranean glass production from the end of the 5<sup>th</sup> century onwards and mostly during the 6<sup>th</sup> and 7<sup>th</sup> century (Saguì 1993, 129; Foy 1995, 207–209; Sternini 1995, 259; Whitehouse 1999; Lafli, Gürler 2010, 434). Together with beakers and bottles they represent a drinking set which, besides glass lamps, presents the only vessels that were in the Late Antiquity still quite frequently made of glass (see chapter 3.7).

### 3.7 LATE ANTIQUE GLASS IN SLOVENIA

#### 3.7.1 STARTING POINT

After the Early Roman period, when the production of glass vessels (secondary production) in the eastern part of the Empire lagged behind Italy in quantity and quality, it started to prosper in the 4<sup>th</sup> and the early 5<sup>th</sup> centuries. This boom is connected to the economic and cultural development of Palestine after Constantine I had started to direct his building activities towards the Holy Land after 324 and after taxes were abolished for certain craftsmen, among them also glassmakers, in 337 (Stern 1999, 481–484).

Between the 5<sup>th</sup> and 8<sup>th</sup> century glass was more and more frequently recycled and was thus consequently of

in to je predvsem zasluga italijanskih in francoskih avtoric (Sternini 1989; 1995; Sagui 1993; Uboldi 1991; 1995; Foy 1995; Foy, Nenna 2001 itd.), ki so razvile tipologije in kronologije steklenih predmetov za Italijo, južno Francijo in tudi severno Afriko (Sternini 1999; Fünfschilling 2006).

Opredelitev steklenih najdb V. Bierbrauerja za Invillino (Bierbrauer 1987, 271–287) ostaja najpomembnejše delo v neposredni okolici Slovenije, vendar je potrebna previdnost pri časovnih določitvah posameznih faz, v katerih se stekleno posodje nahaja (Martin 1992; Sternini 1995, 259). V zahodnem Sredozemlju se kozarci na visoki nogi najverjetneje ne pojavljajo pred koncem 5. st. (Sagui 1993, 129; Ružič 1994, 62; Foy 1995, 207–209; Sternini 1995, 259; Buora 1998, 171; Uboldi 1998, 182–183; Whitehouse 1999; Lafli, Gürler 2010, 434). Tako so tudi na Invillinu najverjetneje zastopani šele po sredini 5. st. in ne že v rimski fazi (Bierbrauer 1987, 273–276).

Obstoj naselbine na Invillinu do zgodnjerednjeveškega obdobja potrjujejo najdbe kozarcev iz modrega stekla z rdečimi progami. Takšno steklo se pojavi že konec 7. st., značilno pa je predvsem za 8. st. (Bierbrauer 1987, 284–285, t. 160: 8–9; Sagui 1993, 131–134; Foy 1995, 216).

S. Ladstätter je obravnavala steklene najdbe iz zahodnega cerkvenega kompleksa Sv. Heme (Ladstätter 2000, 179–185). Stekleno posodje je kratko predstavljeno tudi v objavi poznoantične naselbine Kappele pri Jadersdorfu (Felgenhauer-Schmiedt 1993, 33–34), nekaj najdb pa je znanih tudi z Duela (Steinklauber 1990, 120).

Manj poznega stekla je znanega s Hrvaške in iz Bosne: nekaj posameznih najdb steklenih svetilk omenjata Božič in Ciglencečki (1995, 256), širše obravnavano pa je steklo na primer v objavi cerkvenega kompleksa sv. Ciprijana v Gati (Fadić 1994).

Po pregledu M. Ružič (1994) se je začelo intenzivnejše objavljjanje steklenih poznoantičnih najdb iz današnje Srbije. Najdbe iz podonavskih kastelov omenja P. Špehar (2010, 49–53), pomembni pa sta tudi objavi stekla iz poznoantične in zgodnjerednjeveške utrdbe Vrsenice (Stamenković 2009) in z Gradine na Jelici (Križanac 2009).

Zadnji pregled raziskav stekla v Sloveniji od prazgodovine do srednjega veka je pripravila I. Lazar (2004). Steklo poznoantičnega in zgodnjerednjeveškega obdobja v Sloveniji dolgo ni vzbujalo zanimanja. V zborniku kongresa, ki je leta 1974 potekal na temo srednjeveškega stekla na Balkanu, sta članka S. Petru (1975) in L. Plesničar Gec (1975) obravnavala steklo le do začetka 5. st. Tudi monografska objava rimskega stekla Slovenije I. Lazar (2003a) ne posega preko poznorimskega obdobja.

S. Ciglencečki in D. Božič sta v članku o naselbini Gradec pri Veliki Strmici nekaj strani posvetila tudi

increasingly poor quality. In the eastern Mediterranean the recycled glass was being improved by adding alkaline substances while in the western part this was not possible since they were not available (Dussart et al. 2004, 80–82).

The colour of glass (natural colour) also changed during the Late Antique period. In the 4<sup>th</sup> century glass is still mostly colourless or slightly bluish to greenish. During the first two thirds of the 5<sup>th</sup> century the colour changes to darker shades, mostly olive and dark green. The greenish colour (shades *vert d'eau*, *aqua*) and the decoration of white threads are typical for the first third of the 6<sup>th</sup> century and the glass is very thin. From the mid-6<sup>th</sup> century onwards yellowish shades frequently appear besides green, glass is thicker and more resistant (Foy et al. 2003, 41–42). In the eastern part of the Empire blue-green and green shades prevail at several sites of the Byzantine period (e.g. Gerasa/Jerash, Sardis: Meyer 1988, 217). In the second half of the 7<sup>th</sup> and in the 8<sup>th</sup> centuries light blue glass appears and greatly prevails in the western Mediterranean (Foy et al. 2003, 41–42).

The production of glass mass changed around the middle of the 9<sup>th</sup> century as a consequence of the Arab expansion and political changes in Egypt (Dussart et al. 2004, 76–77). In the eastern Mediterranean halophyte (seaside plants) ash started to be used instead of natron, while in the western part they used the ash of other plants. The old and the new recipe existed alongside each other for quite a long time. In Europe (France, England, Italy), quality glass according to the Roman recipe with natron was still made in the 12<sup>th</sup> century (Uboldi, Verità 2003, 130–132).

The research of Late Antique glass had for a long time been relatively neglected in comparison to the research of the Roman glass. The first classifications of glass material from great eastern Mediterranean sites (Crowfoot, Harden 1931; Harden 1936; Saldern 1962, etc.) are gradually being checked and adapted to new datings of the sites themselves (Sagui 1993, 129; Whitehouse 1999), while a lot of glass still remains unprocessed (overview of the state of research e.g. Lauwers et al. 2007; Lafli, Gürler 2010). The recent decades have revealed a significantly livelier glass research in the western Mediterranean which is primarily the merit of Italian and French authors (Sternini 1989; 1995; Sagui 1993; Uboldi 1991; 1995; Foy 1995; Foy, Nenna 2001 etc.) who developed typologies and chronologies of glass objects for Italy, southern France, and also northern Africa (Sternini 1999; Fünfschilling 2006).

The classification of glass finds by V. Bierbrauer for Invillino (Bierbrauer 1987, 271–287) remains the most important work in the immediate vicinity of Slovenia, yet caution must be taken with time definitions of individual phases in which glass vessels were found (Martin 1992; Sternini 1995, 259). In the western Mediterranean stemmed goblets most probably do not appear before

poznoantičnim svetilkam (Božič, Ciglencečki 1995, 254–257). Prvi, ki se je spoprijel s širšo obravnavo steklenih najdb iz poznoantičnega obdobja pri nas, je bil R. Cunja pri objavi najdb s Kapucinskega vrta v Kopru (Cunja 1989; 1996). Naslanjal se je na tipologijo V. Bierbrauerja, izdelano pri obdelavi najdb z Invillina (Bierbrauer 1987, 271–287). Nekaj let pozneje mu je sledil M. Sagadin z objavo najdb iz Kranja. Prikazane je bilo nekaj steklenega gradiva, predvsem pa je bila predstavljena domnevna steklarska delavnica na severnem dvorišču gradu Kieselstein (Sagadin 2000; 2004). Drugo stekleno gradivo iz Kranja je obravnavano v njegovem doktorskem delu (Sagadin 2008, 80–84), ni pa še objavljeno.

Delno so že objavljene raziskave zgodnjerednjeveškega stekla z Gradišča nad Bašljem, ki kažejo na nadaljevanje predelave in reciklaže starejšega rimskega stekla ter le delno uvoz predmetov, na primer nekaterih steklenih jagod (Šmit et al. 2009; 2010).

Ker se poznoantično steklo s slovenskih najdišč dobro ujema z najdbami stekla iz Sredozemlja, lahko pri analizah uporabljamo aktualne klasifikacije za zahodno Sredozemlje (Sternini 1989; 1995; 1999; Saguì 1993; Ubaldi 1995; Foy 1995; Fünfschilling 2006). Čeprav je poznavanje stekla v Sloveniji v času med 5. in 8., predvsem pa po 9. st. še na začetku, smo pripravili pregled objavljenega stekla iz poznoantičnih naselbin.

Steklo poznamo iz sistematično raziskanih višinskih naselbin. Poleg Tonovcovega gradu (glej pogl. 3.1–3.6) so to: Ajdovski gradec nad Vranjem (Petru, Ulbert 1975; Knific 1979; 1994), Rifnik pri Šentjurju (Bolta 1981), Korinjski hrib nad Velikim Korinjem (Ciglencečki 1985), Ajdna nad Potoki (Leben, Valič 1978) in Tinje nad Loko pri Žusmu (Ciglencečki 2000). Datirane so v konec 5. in 6., včasih še na začetek 7. st. Sakralni center na Kučarju pri Podzemlju je nekoliko zgodnejši, obstajal je od konca 4. in le do konca 5. st. (J. Dular, Ciglencečki, A. Dular 1995).

Posamezne najdbe, ki jih ne moremo ožje datirati, so znane iz višinskih naselbin Križna gora pri Ložu (Urleb 1974), Gradišče nad Bašljem (Žontar 1982, 45, sl. 16), Gradišče nad Dešnom (Pavlin, Dular 2007, 77–78, t. 10: 9) in Vipota nad Pečovnikom (Ciglencečki, Pirkmajer 1987, t. 1: 17).

Višinska utrdba Sv. Pavel nad Vrtovinom (Svoljšak 1985) je bila poseljena v poznoantičnem in še pozneje v zgodnjerednjeveškem obdobju. Tudi od tam poznamo nekaj kosov, ki pa jih lahko postavimo le okvirno med 5. in 8. st.

Nekaj steklenih najdb je znanih tudi iz poznoantičnih plasti v Piranu (Snoj, Novšak 1992) in iz plasti iz časa druge polovice 4. do 6. st. iz pristaniškega kompleksa v Fizinah pri Portorožu (Gaspari et al. 2007). Odlomki svetilk in balzamarija so ležali v ostankih prezbiterija poznoantične cerkve v Šilentaboru (Osmuk 1977; Božič, Ciglencečki 1995, 256–257; Ciglencečki

the end of the 5<sup>th</sup> century (Saguì 1993, 129; Ružič 1994, 62; Foy 1995, 207–209; Sternini 1995, 259; Buora 1998, 171; Ubaldi 1998, 182–183; Whitehouse 1999; Lafli, Gürler 2010, 434). Thus also at Invillino they are most probably represented from the mid-5<sup>th</sup> century onwards and not already during the Roman phase (Bierbrauer 1987, 273–276).

The continuance of the settlement at Invillino into the Early Medieval period is confirmed by the finds of late vessels made of blue glass with red stripes which appears already at the end of the 7<sup>th</sup> century but is most typical of the 8<sup>th</sup> century (Bierbrauer 1987, 284–285, Pl. 160: 8–9; Saguì 1993, 131–134; Foy 1995, 216).

S. Ladstätter discussed glass finds from the western ecclesiastical complex of Hemmaberg (Ladstätter 2000, 179–185). Glass vessels are presented in brief also in the publication of the Late Antique settlement at Kappele near Jadersdorf (Felgenhauer-Schmiedt 1993, 33–34) and a few finds are known also from Duel (Steinklauber 1990, 120).

Less of late glass is known from Croatia and Bosnia: a few individual finds of glass lamps are mentioned by Božič and Ciglencečki (1995, 256) while more attention is for example given to glass in the publication of the ecclesiastical complex of Sv. Ciprijan in Gata (Fadić 1994).

After the overview of M. Ružič (1994) a more intensive period has begun in the publication of Late Antique glass finds from the present-day Serbia. Finds from the Danubian fortifications are mentioned by P. Špehar (2010, 49–53) and the two publications of glass from the Late Antique and Early Medieval fort Vrsenice (Stamenkovič 2009) and from Gradina on Jelica (Križanac 2009) are also of great importance.

The last overview of glass research in Slovenia from prehistory until the Middle Ages was prepared by I. Lazar (2004). Glass of the Late Antique and Early Medieval periods had not aroused any interest in Slovenia for a long time. In the monograph of the congress on Medieval glass in the Balkans from 1974 the articles of S. Petru (1975) and L. Plesničar Gec (1975) discussed glass only until the beginning of the 5<sup>th</sup> century and also the monograph on the Roman glass in Slovenia by I. Lazar (2003a) does not reach beyond the Late Roman period.

S. Ciglencečki and D. Božič dedicated a few pages to Late Antique lamps in the article about the settlement of Gradec near Velika Strmica (Božič, Ciglencečki 1995, 254–257). The first to deal with a more comprehensive discussion of glass finds from the Late Antique period in Slovenia was R. Cunja when he published the finds from Kapucinski vrt in Koper (Cunja 1989; 1996). He relied on the typology of V. Bierbrauer from the publication of the finds from Invillino (Bierbrauer 1987, 271–287). A few years later M. Sagadin published the finds from Kranj. He published some glass material but concentrated on

2003, 17). Noge steklenih kozarcev najdemo tudi v grobovih iz 6. st. na Lajhu v Kranju (Stare 1980, gr. 48, 104, 157) in iz začetka 7. st. na Gorenjem Mokronogu (Bavec 2003, gr. 18, sl. 3: 7–8).

Več stekla je znanega iz Kranja, iz domnevne steklarske delavnice iz 6. st. pri Kieselsteinu (Sagadin 2000; 2004; glej pogl. 3.7.10). V Kopru je bilo precej steklenega posodja odkritega v poznoantičnih in zgodnjerednjevških plasteh (5.–9. st.) pri izkopavanjih na Kapucinskem vrtu (Cunja 1996). V Kranju in Kopru najdbe izvirajo iz kontekstov, vendar stratigrafski podatki niso v celoti objavljeni in tako nepreverljivi.

### 3.7.2 KOZARCI NA VISOKI NOGI

Kozarci na visoki nogi spadajo v tip Isings 111 (Isings 1957, 139–140), razširjeni pa so v poznoantičnem in zgodnjerednjevškem obdobju po vsem Sredozemlju. Do pred nedavnim so domnevali, da so se začeli pojavljati v vzhodnem delu imperija že od 3. st. dalje, predvsem pa v poznorimskem obdobju. Včasih je bila zgodnejša datacija kozarcev na nogi povezana z napačno rekonstrukcijo in interpretacijo odlomkov nog drugih steklenih posod. Podobne oblike kozarcev se pojavljajo namreč že od zgodnjega rimskega obdobja dalje, predvsem pa v 5. st. Za zgodnjeantične kozarce na nogi je značilno, da so noge narejene posebej in dodane pozneje (na primer kozarec iz Žalne pri Veliki Loki: Lazar 2003a, 113). Za 5. st. so značilni kozarci na konični nogi, ki je izvlečena iz istega kosa stekla kot recipient, je nizka in široka (Foy 1995, 200–202).

Zadnje raziskave kažejo, da se kozarci z visoko nogo, izvlečeno iz istega kosa stekla kot recipient ter zapognjeno navznoter, pojavijo pozneje (Sagui 1993, 129; Ružič 1994, 62; Foy 1995, 207–209; Sternini 1995, 259; Buora 1998, 171; Uboldi 1998, 182–183; Whitehouse 1999; Laflı, Gürlıer 2010, 434). V vzhodnem delu imperija se dejansko pojavijo nekoliko prej kot v zahodnem, vendar ne pred sredino 5. st. (Stern 1999, 483). V zahodnem delu se uveljavijo konec 5. st., na jugu današnje Francije in v Italiji pa dokončno prevladajo šele po sredini 6. st. (Foy 1995, 208). Oblika je priljubljena vsaj do 9. st. Kozarce na nogi med 10. in 11. st. v Evropi zelo slabo poznamo. Med 12. in 13. st. se zopet pojavijo in razvijajo naprej (Foy, Sennequier 1989, 199–221).

Visoke noge so lahko tudi polne, izdelane posebej in dodane na recipient, kar je še posebej značilno za kozarce po 6. st. (Foy 1995, 208). Včasih je razlikovanje med votlimi in polnimi visokimi nogami težko, saj se stene votle noge, izdelane iz debelejšega kosa stekla, lahko zlepijo in so videti polne.

Najpogostejša oblika visoke noge kozarca je votla in neokrašena (Foy 1995, 215). Obe obliki, votla in polna,

presenting the supposed glass workshop in the northern courtyard of the Kieselstein castle (Sagadin 2000; 2004). The rest of the glass material from Kranj is encompassed in his doctoral thesis (Sagadin 2008, 80–84) but is not yet published.

Research of the Early Medieval glass from Gradišče above Bašelj has partly been published and indicates the continuation of processing and recycling of older Roman glass and only partially the import of objects, for example individual glass beads (Šmit et al. 2009; 2010).

Since the Late Antique glass from Slovenian sites fits well within the glass finds from the Mediterranean we can, for our analyses, use the current classifications for the western Mediterranean (Sternini 1989; 1995; 1999; Sagui 1993; Uboldi 1995; Foy 1995; Fünfschilling 2006). Despite the fact that the knowledge of glass in Slovenia between the 5<sup>th</sup> and the 8<sup>th</sup> and primarily after the 9<sup>th</sup> century is still at the outset we have prepared an overview of the published glass from the Late Antique settlements.

Glass originates from the systematically researched hilltop settlements. Besides Tonovcov grad (see chapters 3.1–3.6) these include: Ajdovski gradec above Vranje (Petru, Ulbert 1975; Knific 1979; 1994), Rifnik near Šentjur (Bolta 1981), Korinjski hrib above Veliki Korinj (Ciglenečki 1985), Ajdna above Potoki (Leben, Valič 1978), and Tinje above Loka pri Žusmu (Ciglenečki 2000). They are dated to the end of the 5<sup>th</sup> and the 6<sup>th</sup>, sometimes also the beginning of the 7<sup>th</sup> centuries. The sacral centre at Kučar near Podzemelj is somewhat earlier, it lasts from the end of the 4<sup>th</sup> and only until the end of the 5<sup>th</sup> century (J. Dular, Ciglenečki, A. Dular 1995).

Individual finds which cannot be narrowly dated are known from the hilltop settlements Križna gora near Lož (Urleb 1974), Gradišče above Bašelj (Žontar 1982, 45, Fig. 16), Gradišče above Dešen (Pavlin, Dular 2007, 77–78, Pl. 10: 9), and Vipota above Pečovnik (Ciglenečki, Pirkmajer 1987, Pl. 1: 17).

The hilltop fort of Sv. Pavel above Vrtovin (Svoljšak 1985) was settled during the Late Antiquity and also later, during the Early Medieval period. A few pieces originate from this location but can be only roughly assigned to the time between the 5<sup>th</sup> and the 8<sup>th</sup> century.

Some glass finds are known from the Late Antique layers in Piran (Snoj, Novšak 1992) and from the layer of the second half of the 4<sup>th</sup>–6<sup>th</sup> century in the port complex at Fazine near Portorož (Gaspari et al. 2007). Fragments of lamps and of a balsamarium lay in the remains of a Late Antique church presbytery at Šilentabor (Osmuk 1977; Božič, Ciglenečki 1995, 256–257; Ciglenečki 2003, 17). Feet of glass goblets are found in graves of the 6<sup>th</sup> century at Lajh in Kranj (Stare 1980, Gr. 48, 104, 157) and of the early 7<sup>th</sup> century in Gorenji Mokronog (Bavec 2003, Gr. 18, Fig. 3: 7–8).

sta lahko okrašeni,<sup>2</sup> vendar se zdi, da se različne variante okrasa pojavljajo v različnih obdobjih in na različnih območjih ter so predvsem odvisne od mode in okusa (Foy 1995, 215; Fünfschilling 2006, 148).

Okras iz belih ali modrih nataljenih niti je značilen za konec 5. in začetek 6. st. (Foy 1995, 204). Bele niti naj bi bile značilnejše za Zahod, modre pa za Vzhod (Fünfschilling 2006, 145). Steklo okrasa je bilo manj kakovostno od tistega, iz katerega so izdelani kozarci, zato je pogosto odpadlo. V tem primeru na kozarcih ostane le odtis nataljenih niti v obliki horizontalnih prog oz. črt.

Po 7. st. je značilno, da so nege kozarcev lahko daljše in velikokrat tordirane, pogosteje se pojavljajo tudi polne noge (Foy 1995, 210–211, tip 27; Fünfschilling 2010, sl. 8). Konec 7. in v 8. st. se spremeni barva stekla, ki je sedaj najpogosteje svetlomodro z rdečimi progami v stekleni masi, kozarci pa so še dodatno okrašeni z belimi (predvsem v Italiji, Sagui 1993, 131) ali rumenimi steklenimi nitmi. Ta sprememba barve velja za zahodno Sredozemlje (Sagui, Mirti 2003, 88–89, sl. 6, 8) kot tudi za severno Francijo in ostala območja pod karolinškim vplivom (Evison 1989, 138).

Kozarci na nogi so v pozni antiki in zgodnjem srednjem veku izredno razširjeni. Pojavljajo se praktično na vseh najdiščih iz 6. in 7. st., poleg tega pa so pogost pridelek v bogatejših grobovih merovinške srednje Evrope ter langobarskodobne Italije. Predvidevamo lahko, da so to kozarci za vino, omenjeni v bizantinskih pisnih virih (Talbot 2005, 143). Uporaba keliha v krščanski liturgiji je gotovo vsaj eden od povodov za razcvet te oblike. Njihovo prisotnost bi vsaj v cerkvenih objektih lahko razlagali s posnemanjem dražjih in težje dosegljivih posod iz dragocenih kovin. Na to misel nas napeljuje podobnost v okrasu obeh skupin posodja (prim. zaklad iz Grupignana: Menis 1990, 353, IX.21) ter dejstvo, da je posnemanje srebrnega in zlatega posodja tako v keramiki kot steklu pogost pojav v vseh obdobjih.

Votle in neokrašene noge kozarcev so bile najdene na Tonovcovem gradu (glej pogl. 3.1.2), poleg tega pa še v Piranu (Snoj, Novšak 1992, t. 2: 2–3), na Korinjskem hribu (Ciglencečki 1985, t. 5: 58–59), v hiši A na Ajdovskem gradu nad Vranjem (Knific 1979, kat. 39–40), na Rifniku

<sup>2</sup> Svitkaste odebelitve (polne noge npr. Iasos: Baldoni, Berti 1998, sl. 11; Koper: Cunja 1996, t. 4: 60–65), kroglaste odebelitve (polne noge npr. Iasos: Baldoni, Berti 1998, sl. 12; Srbija [*Novae*]: Ružić 1994, t. XL: 11; votle npr. Koper: Cunja 1996, t. 4: 69–71; Sv. Pavel nad Vrtovinom: Svoljšak 1985, t. 2: 38; Nin–Ždrijac: Belošević 1980, t. XXVI: 34), tordiranje (npr. Rim: Sagui 1993, sl. 9: 80; Kartagina: Fünfschilling 2006, sl. 3: 7; Invillino: Bierbrauer 1987, t. 144: 23; Kranj: Sagadin 2004, sl. 6: 12). Lahko so okrašene tudi same stojne ploskve (npr. Rim: Sagui 1993, sl. 93: 79; Srbija [*Pontes, Novae*]: Ružić 1994, t. XL: 10–11). V redkih primerih je bil kozarec pihan v kalup, zato ima recipient valovito površino (npr. Srbija [*Pontes*]: Ružić 1994, t. XL: 10; Italija [*Borgo d'Ale*]: Sternini 1995, 261).

More glass is known from Kranj, from the supposed glass-making workshop of the 6<sup>th</sup> century near Kieselstein (Sagadin 2000; 2004; see chapter 3.7.10). In Koper, a fair amount of glass vessels was discovered in the Late Antique and Early Medieval layers (5<sup>th</sup>–9<sup>th</sup> centuries) during the excavations at Kapucinski vrt (Cunja 1996). In Kranj and Koper the finds come from contexts but the stratigraphic data are not completely published and are thus unverifiable.

### 3.7.2 STEMMED GOBLETs

Stemmed goblets belong to type Isings 111 (Isings 1957, 139–140) and are present during the Late Antique and Early Medieval period in the entire Mediterranean. Until recently it was believed that these started to appear in the eastern part of the Empire from the 3<sup>rd</sup> century onwards and definitely in the Late Roman period. Occasionally the earlier dating of the stemmed goblets was related to the erroneous reconstruction and interpretation of feet fragments of other glass vessels. Namely, similar forms of glass vessels appear from the early Roman period onwards and mostly in the 5<sup>th</sup> century. It is typical for Early Antique footed goblets that the feet are made separately and added later (e.g. goblet from Žalna near Velika Loka: Lazar 2003a, 113). Beakers on a low and wide conical foot which is pulled out of the same piece of glass as the recipient are typical for the 5<sup>th</sup> century (Foy 1995, 200–202).

Recent research shows that stemmed goblets with the stem and foot pulled out of the same piece of glass as the recipient and folded inwards appear later (Sagui 1993, 129; Ružić 1994, 62; Foy 1995, 207–209; Sternini 1995, 259; Buora 1998, 171; Uboldi 1998, 182–183; Whitehouse 1999; Lafli, Gürler 2010, 434). In the eastern part of the Empire they actually appear slightly earlier than in the western but not before the mid-5<sup>th</sup> century (Stern 1999, 483). In the western part they become established at the end of the 5<sup>th</sup> century and completely prevail at the south of France and in Italy only after the mid-6<sup>th</sup> century (Foy 1995, 208). This form remains popular at least until the 9<sup>th</sup> century. Stemmed goblets are not well-known in Europe during the 10<sup>th</sup> and 11<sup>th</sup> centuries. They reappear between the 12<sup>th</sup> and 13<sup>th</sup> centuries and develop further (Foy, Sennequier 1989, 199–221).

Stems and feet can also be full, made separately and added to the recipient, which is especially characteristic for goblets after the 6<sup>th</sup> century (Foy 1995, 208). Sometimes the differentiation between full and hollow stems can be difficult because the walls of hollow stems made from a thicker piece of glass can merge and thus appear full.

The most frequent form of a stem is hollow and undecorated (Foy 1995, 215). Both forms, hollow and

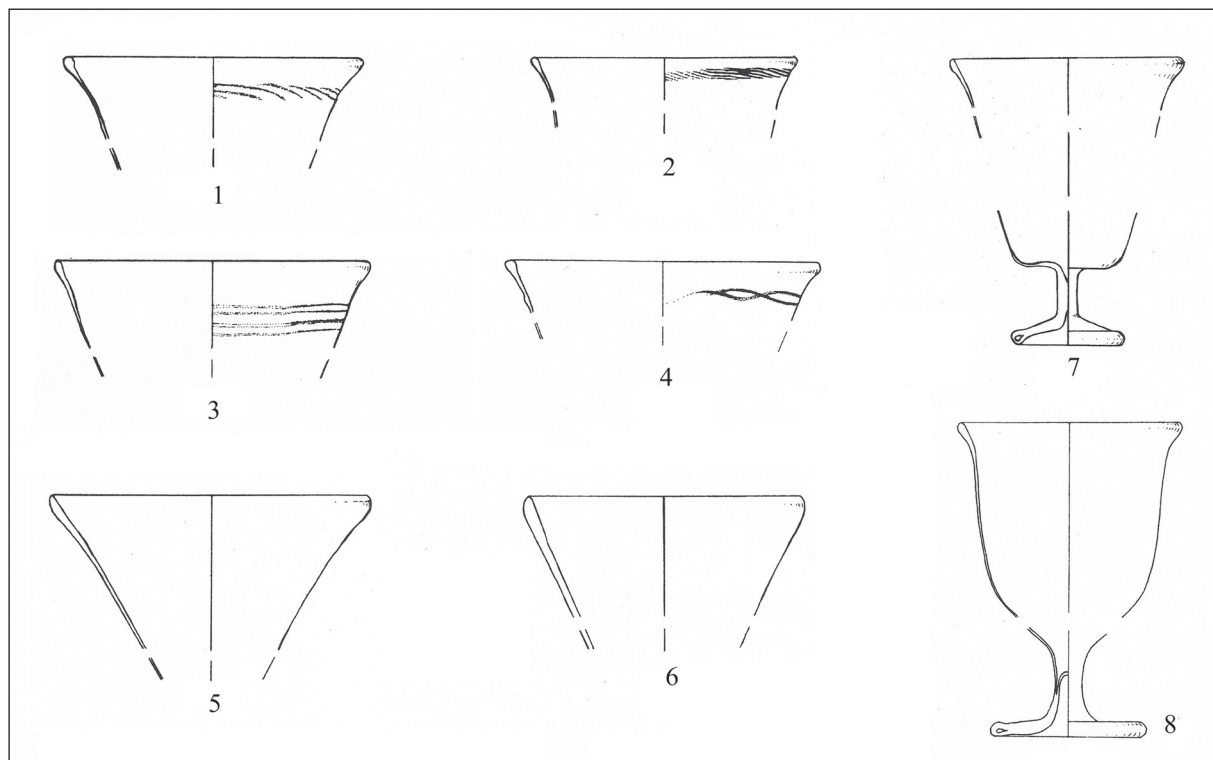

Sl. 3.5: Koper, Kapucinski vrt, kozarci na visoki nogi (po Cunja 1996, t. 3: 41,47–49,51–52,58–59). Steklo. M. = 1:2.  
 Fig. 3.5: Koper, Kapucinski vrt, stemmed goblets (after Cunja 1996, Pl. 3: 41,47–49,51–52,58–59). Glass. Scale = 1:2.

(Bolta 1981, t. 25: 75; 26: 18; 27: 57), Sv. Pavlu nad Vrtovinom (Svoljšak 1985, t. 1: 11–12), Križni gori pri Ložu (Urleb 1974, sl. 153: 20), Gradišću nad Bašljem (Žontar 1982, 45, sl. 16) in Gradišću nad Dešnom (Pavlin, Dular 2007, 77–78, t. 10: 9). V grobovih so bile noge kozarcev najdene v treh primerih na kranjskem grobišču iz 6. st. na Lajhu (Stare 1980, gr. 48: t. 22: 7; gr. 104: t. 39: 5; gr. 157: t. 53: 1) in v enem na Vrajku v Gorenjem Mokronogu, datiranem v začetek 7. st. (Bavec 2003, gr. 18, sl. 3: 7–8).

Na omenjenih najdiščih (Korinjski hrib, Ajdovski gradec, Rifnik), katerih glavni razcvet je bil v 6. st., je bilo najdenih le po nekaj kosov nog kozarcev. Edini najdišči poleg Tonovcovega gradu, kjer je bil ta tip posodja najden v večjih količinah, sta Koper (Cunja 1996) in Kranj (Sagadin 2000; 2004).

Recipienti kozarcev iz Kopra (sl. 3.5, 3.6) so večinoma konični, barva stekla (naravno obarvano) pa je v otenkih med zeleno in rumeno. Koprsko gradivo je bilo mogoče razdeliti na štiri skupine (Cunja 1996, 71–78).

V prvi skupini so kozarci na votli nogi (sl. 3.5: 7–8), kakršni so najdeni tudi na Tonovcovem gradu (t. 56: 11–36). Ta oblika noge je v Sloveniji daleč najpogosteje zastopana (glej zgoraj).

Drugo skupino, za katero so značilne polne noge s svitkasto odebelitvijo (sl. 3.6: 1), je Cunja datiral med 7. in 9. st., saj zanjo takrat ni našel dobrih primerjav (Cunja 1996, 76–77). S. Fünfschilling datira kozarce s polno nogo in svitkasto odebelitvijo v Tuniziji, kjer so

full, can be decorated,<sup>2</sup> yet it seems that different variants of the decoration appear in different periods and at different areas and are primarily dependant on fashion and taste (Foy 1995, 215; Fünfschilling 2006, 148).

The trailed decoration of white or blue threads is characteristic for the end of the 5<sup>th</sup> and the beginning of the 6<sup>th</sup> century (Foy 1995, 204). White threads were supposedly more typical for the West and blue for the East (Fünfschilling 2006, 145). Decoration glass was of poorer quality than the one goblets are made of thus it frequently fell off. If so, goblets sometimes have impressions of threads in the shape of horizontal stripes or lines.

After the 7<sup>th</sup> century it is typical that the stems of goblets can be longer and often twisted, full stems also appear more frequently (Foy 1995, 210–211; type 27;

<sup>2</sup> Coil-shaped knobs (full stems e.g. Iasos: Baldoni, Berti 1998, Fig. 11; Koper: Cunja 1996, Pl. 4: 60–65), globular knobs (full stems e.g. Iasos: Baldoni, Berti 1998, Fig. 12; Serbia [Novae]: Ružić 1994, Pl. XL: 11; hollow stems e.g. Koper: Cunja 1996, Pl. 4: 69–71; Sv. Pavel above Vrtovin: Svoljšak 1985, Pl. 2: 38; Nin-Ždrijac: Belošević 1981, Pl. XXVI: 34), twisting (e.g. Rome: Sagui 1993, Fig. 9: 80; Carthage: Fünfschilling 2006, Fig. 3: 7; Invillino: Bierbrauer 1987, Pl. 144: 23; Kranj: Sagadin 2004, Fig. 6: 12). The feet can also be decorated (e.g. Rome: Sagui 1993, Fig. 93: 79; Srbija [Pontes, Novae]: Ružić 1994, Pl. XL: 10–11). Rarely the goblet was mould-cast, thus the recipient has a wavy surface (e.g. Serbia [Pontes]: Ružić 1994, Pl. XL: 10; Italy [Borgo d'Ale]: Sternini 1995, 261).

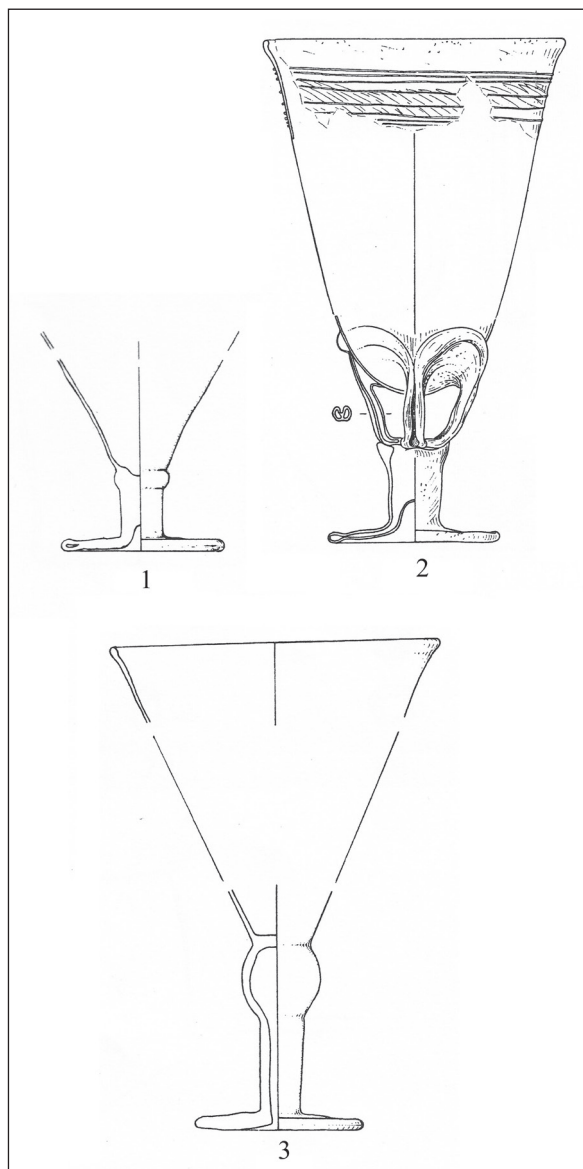

Sl. 3.6: Koper, Kapucinski vrt, kozarci na visoki nogi (po Cunja 1996, t. 4: 60,68–69). Steklo. M. = 1:2.

Fig. 3.6: Koper, Kapucinski vrt, stemmed goblets (after Cunja 1996, Pl. 4: 60,68–69). Glass. Scale = 1:2.

številni, v drugo polovico 6. st. (Fünfschilling 2006, 145, sl. 3: 3). Kozarci s polno nogo so v južni Franciji redki in poznejši od kozarcev z votlo nogo. Pojavljajo se konec 6. in v 7. st. (Foy 1995, 208–209).

Za tretjo skupino kozarcev iz Kopra so značilne votle noge z loki, ki nosijo recipient (sl. 3.6: 2). Na podlagi najdiščnih kontekstov so v Koprú datirani v 6.–7. st. (Cunja 1996, 77). Ti zelo zanimivi kozarci nimajo veliko primerjav. Dva enaka kozarca sta že dolgo znana med najdbami iz Akvileje (Calvi 1969, t. 27; tam datirana v 4. st.). Eden je bil najden v naselbini na Monte Barru, ki je živela med koncem 5. in sredino 6. st., nekaj takšnih odlomkov pa v cerkvi San Tomè pri Carvicu v bližini

Fünfschilling 2010, Fig. 8). At the end of the 7<sup>th</sup> and in the 8<sup>th</sup> century the colour of the glass changes and is now usually light blue with red stripes in the glass mass, while goblets are additionally decorated by white (mostly in Italy: Sagui 1993, 131) or yellow threads. This change in colour is true for the western Mediterranean (Sagui, Mirti 2003, 88–89, Figs. 6, 8) and also northern France and other territories under the Carolingian influence (Evison 1989, 138).

Stemmed goblets are extremely wide-spread during Late Antiquity and Early Middle Ages. They appear at practically all sites of the 6<sup>th</sup> and 7<sup>th</sup> centuries and are also a frequent grave good of the richer graves of the Merovingian central Europe and Lombard Italy. We can assume that these are the wine glasses mentioned in the Byzantine written sources (Talbot 2005, 143). The use of the goblet in Christian liturgy is at least one of the reasons why this form flourished. Their presence could, at least in churches, be explained by imitation of more expensive and more difficult to acquire vessels made of precious metals. This idea is induced by the similarity of decoration of both vessel types (cf. treasure from Grupignano: Menis 1990, 353, IX.21) and the fact that imitation of silver and glass vessels is a frequent occurrence in all periods both with pottery and glass.

Hollow and undecorated goblet stems and feet were besides at Tonovcov grad (see chapter 3.1.2) found also in Piran (Snoj, Novšak 1992, Pl. 2: 2–3), at Korinjski hrib (Ciglencečki 1985, Pl. 5: 58–59), in house A at Ajdovski gradec above Vranje (Knific 1979, cat. nos. 39–40), at Rifnik (Bolta 1981, Pls. 25: 75; 26: 18; 27: 57), at Sv. Pavel above Vrtovin (Svoljšak 1985, Pl. 1: 11–12), Križna gora near Lož (Urleb 1974, Fig. 153: 20), Gradišče above Bašelj (Žontar 1982, 45, Fig. 16), and at Gradišče above Dešen (Pavlin, Dular 2007, 77–78, Pl. 10: 9). In graves, goblet stems and feet were found in three examples at the cemetery of the 6<sup>th</sup> century in Kranj at Lajh (Stare 1980, Grave 48: Pl. 22: 7; Grave 104: Pl. 39: 5; Grave 157: Pl. 53: 1) and once at Vrajk in Gorenji Mokronog, which is assigned to the beginning of the 7<sup>th</sup> century (Bavec 2003, Gr. 18, Fig. 3: 7–8).

At the above mentioned sites (Korinjski hrib, Ajdovski gradec, Rifnik), the main prosperity of which belongs to the 6<sup>th</sup> century, only a few pieces of goblet stems and feet were found. There are only two sites besides Tonovcov grad where this type of vessels was found in greater numbers and these are Koper (Cunja 1996) and Kranj (Sagadin 2000; 2004).

The goblet recipients from Koper (Figs. 3.5, 3.6) are mostly conical and the glass colour (naturally coloured) appears in shades between green and yellow. It was possible to divide the material from Koper into four groups (Cunja 1996, 71–78).

The first group is formed of goblets on hollow stem (Fig. 3.5: 7–8), such as were also found at Tonovcov grad

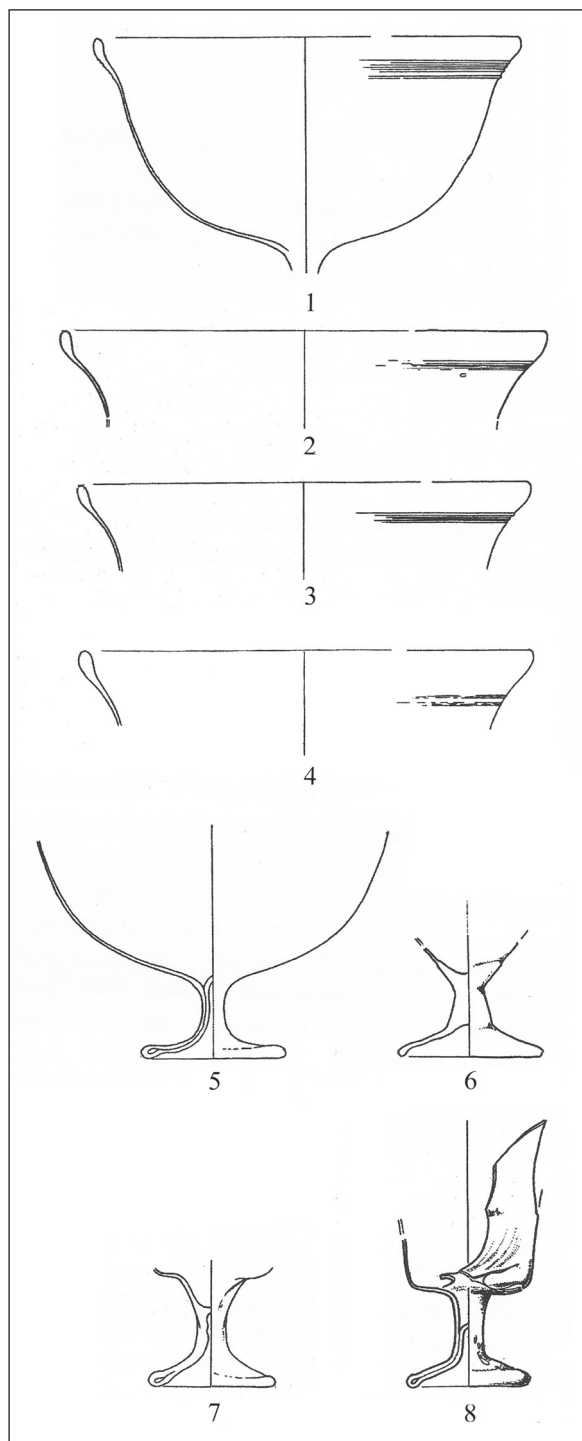

Sl. 3.7: Kranj, Kieselstein, kozarci na visoki nogi (po Sagadin 2004, sl. 6: 1-3,5-9). Steklo. M.= 1:2.

Fig. 3.7: Kranj, Kieselstein, stemmed goblets (after Sagadin 2004, Fig. 6: 1-3,5-9). Glass. Scale = 1:2.

Monte Barra, ki je bila v uporabi med 7. in 11. st. (Uboldi 1991, t. LV: 6; 1995, 97, op. 20; Uboldi, Verità 2003, 122-123). Kozarec z enakimi loki, ki držijo recipient, je bil odkrit tudi v natančneje neopredeljenih "bizantinskih" plasteh v teatru v Niceji (Çelik 2009, 154, sl. 7-9).

(Pl. 56: 11-36) and represent by far the most frequent form of stems in Slovenia (see above).

The second group, for which full stems with a coil-shaped knob are characteristic (Fig. 3.6: 1), was dated by Cunja between the 7<sup>th</sup> and 9<sup>th</sup> century since at the time he could not find any appropriate analogies for it (Cunja 1996, 76-77). S. Fünfschilling dates goblets with full stem and a coil-shaped knob in Tunisia, where there are many, to the second half of the 6<sup>th</sup> century (Fünfschilling 2006, 145, Fig. 3: 3). Goblets with full stem are rare in southern France and appear later than goblets on hollow stem, at the end of the 6<sup>th</sup> and in the 7<sup>th</sup> century (Foy 1995, 208-209).

The third group of goblets from Koper have hollow stems with arches that carry the recipient (Fig. 3.6: 2). On the basis of the site contexts they are dated to the 6<sup>th</sup>-7<sup>th</sup> century in Koper (Cunja 1996, 77). These very interesting goblets do not have many analogies. Two identical goblets have been for a long time known among the finds from Aquileia (Calvi 1969, Fig. 27; there dated to the 4<sup>th</sup> century). One was found in the settlement at Monte Barro, which functioned between the end of the 5<sup>th</sup> and the middle of the 6<sup>th</sup> century, and some fragments were found in the church San Tomè near Carvico in the vicinity of Monte Barro, which was in use between the 7<sup>th</sup> and 11<sup>th</sup> century (Uboldi 1991, Pl. LV: 6; 1995, 97, note 20; Uboldi, Verità 2003, 122-123). A goblet with identical arches holding the recipient was discovered also in the precisely undefined 'Byzantine layers' in the theatre in Nicea (Çelik 2009, 154, Figs. 7-9).

Goblets of the fourth Koper group with conical recipients and hollow stems with a globular knob (Fig. 3.6: 3; Cunja 1996, 74) have the only two found comparisons in goblets from graves 322 and 310 at the cemetery Nin-Ždrijac in Croatia (Belošević 1980, Pls. XXVI: 34; XXXIV: 80), which are dated to the end of the 8<sup>th</sup> and the beginning of the 9<sup>th</sup> century. In grave 322 a bottle with a globular recipient, narrow neck, and trailed decoration of the so-called 'frills' was also found and for which good analogies can be found among the material from the eastern part of the Empire which are dated to the time from the 7<sup>th</sup> century on (Meyer 1988, 206-207). A fragment of a goblet stem and foot belonging to the same group was found at Sv. Pavel above Vrtovin (Fig. 3.8: 2; Svoljšak 1985, Pl. 2: 38, turned upside down), the settlement of which reaches to the 7<sup>th</sup> or 8<sup>th</sup> century (Svoljšak 1985, 220).

The recipients of stemmed goblets from Kranj from the 6<sup>th</sup> century (Sagadin 2004, Fig. 6: 6-14) are mostly wide and bell-shaped (type A according to Bierbrauer: Fig. 3.7: 1,5), some are also cylindrical (type B: Fig. 3.7: 8). Stems are mostly hollow, one of them is twisted (Sagadin 2004, Fig. 6: 12). One full stem which is in the middle slightly compressed is also published (Fig. 3.7: 6; Sagadin 2004, Fig. 6: 7). In Slovenia, another full



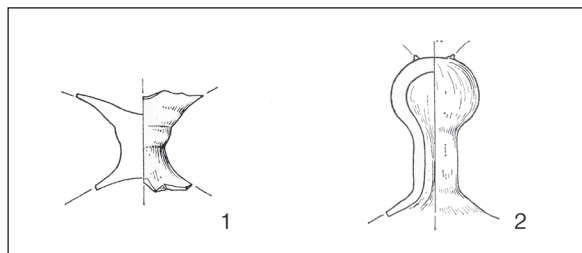

Sl. 3.8: Sv. Pavel nad Vrtovinom, nogi kozarcev (po Svoljšak 1985, t. 2: 38; 4: 74). Steklo. M. = 1:2.

Fig. 3.8: Sv. Pavel above Vrtovin, stemmed goblets (after Svoljšak 1985, Pls. 2: 38; 4: 74). Glass. Scale = 1:2.

Kozarcem četrte kopsrke skupine s koničnimi recipienti in visoko votlo nogo s kroglasto odebelitvijo (sl. 3.6: 3; Cunja 1996, 74) sta edini najdeni primerjavi kozarca iz grobov 322 in 310 na grobišču Nin-Ždrijac na Hrvaškem (Belošević 1980, t. XXVI: 34; XXXIV: 80), ki sta datirana v konec 8. in začetek 9. st. V grobu 322 je bila najdena tudi steklenica s kroglastim recipientom, ozkim vratom in nataljenim okrasom t. i. "volančkov". Ta steklenica ima dobre primerjave med gradivom iz vzhodnega dela imperija, ki so datirane v čas od 7. st. dalje (Meyer 1988, 206–207). Odlomek noge kozarca, ki lahko spada v isto skupino, je bil najden tudi na Sv. Pavlu nad Vrtovinom (sl. 3.8: 2; Svoljšak 1985, t. 2: 38, obrnjena narobe), katerega poselitev sega do 7. ali 8. st. (Svoljšak 1985, 220).

Recipienti kozarcev na nogi iz Kranja iz 6. st. (Sagadin 2004, sl. 6: 6–14) so v večini širši in zvončaste oblike (tip A po Bierbrauerju: sl. 3.7: 1,5), nekateri so tudi cilindrični (tip B: sl. 3.7: 8). Noge so večinoma votle, med njimi je ena tordirana (Sagadin 2004, sl. 6: 12). Objavljena je tudi ena polna noga, na sredini rahlo stisnjena (sl. 3.7: 6; Sagadin 2004, sl. 6: 7). V Sloveniji je bila še ena polna noga najdena na Sv. Pavlu nad Vrtovinom (sl. 3.8: 1; Svoljšak 1985, t. 4: 74 [obrnjena narobe]), ki je bil poseljen tako v poznoantičnem kot v zgodnjeresrednjeveškem obdobju. Polne noge, ki so na sredini nekoliko stisnjene, D. Foy datira še v poznejši čas kot navadne polne noge, torej v sam konec 6. in v 7. st. Pogosto so izdelane že iz poznega modrega stekla (Foy et al. 2003, 208–209). V Srbiji (*Novae, Pontes, Mihajlovac*) so bile polne noge najdene v justinijanskih kastelih (Ružić 1994, t. XL: 5–7).

### 3.7.3 KOZARCI BREZ NOGE

Tudi kozarci brez noge so pogoste najdbe na višinskih postojankah s konca 5. in 6. st. V Sloveniji so bila vbočena dna kozarcev najdena na Tonovcovem gradu (glej pogl. 3.1.4), v cerkvi na Ajdni (Leben, Valič 1978, t. 2: 25), na Vipoti (Ciglenečki, Pirkmajer 1987, t. 1: 17), v hišah A in B na Ajdovskem gradu nad Vranjem (Knific

stem was found at Sv. Pavel above Vrtovin (Fig. 3.8: 1; Svoljšak 1985, Pl. 4: 74, turned upside down), which was settled during the Late Antiquity and the Early Middle Ages. Full stems which are slightly compressed in the middle are dated by D. Foy even later than the ordinary full stems, therefore to the end of the 6<sup>th</sup> and to the 7<sup>th</sup> century, and are often made of the late blue glass (Foy et al. 2003, 208–209). In Serbia (*Novae, Pontes, Mihajlovac*) full stems were found in fortifications of Justinian's period (Ružić 1994, Pl. XL: 5–7).

### 3.7.3 BEAKERS

Beakers are also frequent finds at the hilltop settlements of the end of the 5<sup>th</sup> and the 6<sup>th</sup> centuries. In Slovenia, concave bases of beakers were besides at Tonovcov grad (see chapter 3.1.4) found also in the church at Ajdna (Leben, Valič 1978, Pl. 2: 25), at Vipota (Ciglenečki, Pirkmajer 1987, Pl. 1: 17), in houses A and B at Ajdovski gradec above Vranje (Knific 1979, cat. nos. 37–38, 166), at Tinje (Ciglenečki 2000, Pl. 7: 15–16), and Rifnik (Bolta 1981, Pls. 19: 52–53; 21: 76; 26: 53). A cut rim, typical for this form, was found at Kučar (J. Dular, Ciglenečki, A. Dular 1995, Pl. 83: 18).

Beakers with concave base are divided into types Isings 96, 106, 107, and 109 with subtypes (Isings 1957, 126–138) or to types 3.8.6., 3.9.1., and 3.9.2. according to I. Lazar (2003a, 116–121).

As all beakers these could also be used as lamps. In the eastern Mediterranean, for example, globular cups (Isings 96; Antonaras 2007, 53–54, Fig. 5: 3a) or conical beakers (Crowfoot, Harden 1931, Pl. XXVIII: 4–10) were used in this manner. Inserted as lamps into chandeliers, conical beakers without standing surface or beakers with a base of a very small diameter were used.

The olive green colour of glass, which is supposed to be the consequence of recycling (e.g. Lazar 2003a, 240; Dussart et al. 2004, 81), is typical for beakers and bowls of the beginning of the 5<sup>th</sup> century. Other authors believe that this shade is the consequence of a poorer glass mass oxidation as is needed for the occurrence of the so-called *aqua* green colour (Tal et al. 2004, 64).

It is typical for the rims of types Isings 106 and 109 that they are mostly cut, only a few are fire-rounded. At Tonovcov grad, for example, very few cut rims (Pls. 54: 6; 59: 12; 61: 20) were found but quite a few bases, thus we suppose that most of the beakers had fire-rounded rims, the same as stemmed goblets (Pls. 54: 7–26; 55: 1–27; 56: 1–10). This peculiarity could be the characteristic of a certain workshop or could be limited to a certain time period. For example, graves in Ptuj reveal beakers with fire-rounded rims already at the end of the 4<sup>th</sup> century (Tušek 1997, Pls. 1: 4; 4: 6) while in Brescia these do not yet appear even in the 5<sup>th</sup> century (Uboldi 1998, 182).

1979, kat. 37–38, 166), na Tinju (Ciglencečki 2000, t. 7: 15–16) in na Rifniku (Bolta 1981, t. 19: 52–53; 21: 76; 26: 53). Ravno odrezano ustje, značilno za to obliko, je bilo najdeno na Kučarju (J. Dular, Ciglencečki, A. Dular 1995, t. 83: 18).

Kozarci brez noge z vbočenim dnom so razdeljeni v tipe Isings 96, 106, 107 in 109 s podtipi (Isings 1957, 126–138) oz. v tipe 3.8.6., 3.9.1. in 3.9.2. po I. Lazar (2003a, 116–121).

Vsi kozarci so se lahko uporabljali tudi kot svetilke. Tako so v vzhodnem Sredozemlju uporabljali na primer polkrožne čaše (Isings 96; Antonaras 2007, 53–54, sl. 5: 3a) ali konične kozarce (Crowfoot, Harden 1931, t. XXVIII: 4–10). Kot svetilke so bili vstavljeni v lestence konični kozarci brez stojne ploskve ali kozarci z dnom zelo majhnega premera.

Za kozarce, čaše in skodelice iz začetka 5. st. je zelo značilna olivno zelena barva stekla, za katero nekateri domnevajo, da je posledica recikliranja (npr. Lazar 2003a, 240; Dussart et al. 2004, 81). Drugi avtorji pa menijo, da je ta odtenek posledica slabše oksidacije steklene mase, kot je potrebna za nastanek t. i. vodno zelene barve (Tal et al. 2004, 64).

Značilno za ustja tipov Isings 106 in 109 je, da so v večini primerov ravno odrezana in obrušena, le nekatera so tudi zataljena. Na Tonovcovem gradu, na primer, je bilo v nasprotju z nekaj najdbami dnov najdenih zelo malo odrezanih ustij (t. 54: 6; 59: 12; 61: 20), zato predpostavljamo, da je imela večina kozarcev brez noge tudi zataljena ustja, tako kot kozarci na visoki nogi (t. 54: 7–26; 55: 1–27; 56: 1–10). Ta posebnost je lahko značilnost delavnice, morda pa je tudi časovno pogojena. V grobovih na Ptujju so na primer že konec 4. st. ležali kozarci z zataljenim ustjem (Tušek 1997, t. 1: 4; 4: 6), medtem ko se v Brescii v 5. st. še ne pojavljajo (Uboldi 1998, 182). Za kontekste iz Crypte Balbi v Rimu je značilno, da so v prvi polovici 5. st. zataljena ustja celo pogostejša od obrušenihi, čeprav naj bi bila na splošno do konca 5. st. redka (Sagui 1993, 118).

Kozarci brez noge so na splošno datirani v 4. in začetek 5. st. (Lazar 2003a, 117). Kot kažejo tipološke razpredelnice za zahodno Sredozemlje, oblike kozarcev brez noge izginejo do konca 5. st. (Sternini 1995, 259, 261). Na nekaterih najdiščih, na primer na Monte Barru (Uboldi 1991, 85), jih v 6. st. dejansko ne najdemo. Na drugih poznoantičnih najdiščih so bili kozarci brez noge očitno v rabi tudi v 5. st. ali celo pozneje (Ajdna, Vipota, Ajdovski gradec, Tinje, Rifnik: glej zgoraj; Sv. Hema na Koroškem: Ladstätter 2000, 179–180). Težko prepoznamo celotno obliko poznejših kosov, saj v nasprotju s poznorimskim obdobjem nimamo ohranjenih celih posod.

Uboldijeva predvideva, da so pogosto najdena zataljena ustja v plasteh iz začetka oz. sredine 6. st. v Brescii (S. Giulia) pripadala kozarcem z vbočenim dnom, saj je nog kozarcev na nogi pred drugo polovico 6. st. še zelo

It is typical for contexts from Crypta Balbi (Sagui 1993, 118) in Rome that during the first half of the 5<sup>th</sup> century fire-rounded rims are even more frequent than cut ones, despite the fact that in general they were supposedly very rare until the end of the 5<sup>th</sup> century.

Beakers are generally dated to the 4<sup>th</sup> and the beginning of the 5<sup>th</sup> century (Lazar 2003a, 117). As shown by the typological charts for the western Mediterranean, beakers disappear until the end of the 5<sup>th</sup> century (Sternini 1995, 259, 261). They are in fact not present in the 6<sup>th</sup> century at certain sites, for example at Monte Barro (Uboldi 1991, 85). At other Late Antique sites beakers were obviously in use also in the 5<sup>th</sup> century and even later (Ajdna, Vipota, Ajdovski gradec, Tinje, Rifnik: see above; Hemmaberg in Carinthia: Ladstätter 2000, 179–180). It is difficult to recognise the whole form of later pieces since unlike the Late Roman period we do not have any whole vessels preserved.

For Brescia (S. Giulia), Uboldi presumes, considering the frequent finds of fire-rounded rims in layers from the beginning or the middle of the 6<sup>th</sup> century that they belonged to beakers with a concave base since there are very few feet of stemmed goblets prior to the second half of the 6<sup>th</sup> century (Uboldi 1998, 182). Beakers were also still used during the 6<sup>th</sup> and 7<sup>th</sup> centuries in the Venetian lagoon (Torcello and San Francesco del Deserto: Ferri 2006, 181) and in Croatia (Fadić 1994, 213, 217).

### 3.7.4 CLOSED FORMS

Bottle fragments were besides Tonovcov grad (see chapter 3.1.5) found also at Late Antique settlements at Korinjski hrib (Ciglencečki 1985, Pl. 5: 56; rim), Kučar (J. Dular, Ciglencečki, A. Dular 1995, Pl. 84: 12; a funnel-shaped rim), Sv. Jakob above Potoče (Valič 1990, Fig. 6: 3; a funnel-shaped rim), Tinje (Ciglencečki 2000, Pl. 7: 14, 17; a base and part of a wall in buildings 2 and 5), and Kranj (Sagadin 2004, Fig. 6: 18; concave base).

Some more bottles appear at Invillino (Bierbrauer 1987, 282–283).

Nowhere in the Mediterranean during the Late Antiquity and Early Middle Ages bottles are as frequent as stemmed goblets or lamps but they still appear. It is difficult to reconstruct their form due to the fact that they are usually preserved only fragmentarily. They mostly had an everted or funnel-shaped rim, medium long and wide neck, and a globular or cylindrical recipient (Foy 1995, Pl. 16; Sternini 1995, Fig. 20: 55–59; Fünfschilling 2006, Fig. 3: 11; Atik 2009, Figs. 12, 15). They developed from forms Isings 101–103 and 132 (Lazar 2003a, 141, 144–149). Bottles substitute jugs already during the second half of the 3<sup>rd</sup> century, then bottles with handles also slowly disappear, and after the 5<sup>th</sup> century only those without handles remain (Lazar 2003a, 233–234). Between the 5<sup>th</sup> and the 7<sup>th</sup> century bottles without handles appear in Italy (Sagui

malo (Uboldi 1998, 182). Kozarci brez noge so bili v rabi še v 6. in 7. st. tudi v Beneški laguni (Torcello in San Francesco del Deserto: Ferri 2006, 181) in na Hrvaškem (Fadić 1994, 213, 217).

### 3.7.4 ZAPRTE OBLIKE

Odlomki steklenic so bili najdeni na Tonovcovem gradu (glej pogl. 3.1.5), pa tudi na poznoantičnih postojankah na Korinjskem hribu (Ciglenečki 1985, t. 5: 56; ustje), Kučarju (J. Dular, Ciglenečki, A. Dular 1995, t. 84: 12; lijakasto ustje), Sv. Jakobu nad Potočami (Valič 1990, sl. 6: 3; lijakasto ustje), Tinju (Ciglenečki 2000, t. 7: 14,17; dno in del ostenja v objektih 2 in 5) in v Kranju (Sagadin 2004, sl. 6: 18; vbočeno dno).

Nekaj več steklenic se pojavlja na Invillinu (Bierbrauer 1987, 282–283).

Steklenice nikjer v Sredozemlju v pozni antiki in zgodnjem srednjem veku niso tako pogoste kot kozarci na nogi ali svetilke, vendar se pojavljajo. Ker so običajno ohranjeni samo odlomki, njihovo obliko težko rekonstruiramo. Večinoma so imele izvihano ali lijakasto ustje, srednje dolg in širok vrat ter kroglast ali cilindričen recipient (Foy 1995, t. 16; Sternini 1995, sl. 20: 55–59; Fünfschilling 2006, sl. 3: 11; Atik 2009, sl. 12, 15). Razvile so se iz oblik Isings 101–103 in 132 (Lazar 2003a, 141, 144–149). Steklenice nadomestijo vrče že v drugi polovici 3. st., nato počasi izginejo tudi steklenice z ročaji, po 5. st. pa ostanejo le še takšne brez ročajev (Lazar 2003a, 233–234). Med 5. in 7. st. se steklenice brez ročajev pojavljajo v Italiji (Sagui 1993, sl. 3; Sternini 1995, 260, 262), v Kartagini (Fünfschilling 2006, sl. 3: 11), v Srbiji (Križanac 2009, 268, 269, sl. 4) in na Hrvaškem (Fadić 1994, 220), dokaj redke pa so v južni Franciji (Foy 1995, 209–210).

Steklenice z izvihanim ustjem in kroglastim trupom, katerih celotno obliko se je dalo rekonstruirati, so bile najdene tudi v kontinentalni Evropi, na primer na kölnskem grobišču St. Severin in še na nekaterih nemških grobiščih iz 5. in 6. st. (Päffgen 1992, 1. del, 356–357). V času po 7. st. steklenice praktično izginejo, ostanejo le še manjše stekleničke (Sternini 1995, 262), predvidoma za potrebe liturgije. V 12.–13. stoletju pa se v zahodni Evropi zopet pojavijo v le malo spremenjeni obliki (Foy, Sennequier 1989, kat. 69–80, 109–115).

V Koprju je bil najden del trolistno oblikovanega ustja in narebrenega ročaja vrča (Cunja 1996, t. 5: 78). Podoben narebren ročaj je bil najden na Invillinu (Bierbrauer 1987, t. 157: 23). V Italiji se pojavljajo vrči s podobno oblikovanim ustjem v 6. in 7. st. (Sternini 1995, 262, sl. 20: 53). Primerljivo ustje je ležalo tudi v plasteh, datiranih v čas med 630–679, v Sardah (Meyer 1988, 203, sl. 11: A). Na Sv. Hemi so bili najdeni ustje in dva odlomka nog, ki lahko pripadajo vrčem (Ladstätter 2000, 183). Vrči v zahodnem Sredozemlju po sredini

1993, Fig. 3; Sternini 1995, 260, 262), Carthage (Fünfschilling 2006, Fig. 3: 11), Serbia (Križanac 2009, 268, 269, Fig. 4), and in Croatia (Fadić 1994, 220), while they are quite rare in southern France (Foy 1995, 209–210).

Bottles with an everted rim and globular body, the complete shape of which could be reconstructed, were found also in continental Europe, for example at the Cologne cemetery St Severin and also a few other German cemeteries of the 5<sup>th</sup> and 6<sup>th</sup> centuries (Päffgen 1992, Part 1, 356–357). In the time after the 7<sup>th</sup> century bottles practically disappear, only smaller ones remain (Sternini 1995, 262), supposedly for the use in liturgy. They reappear in western Europe during the 12<sup>th</sup>–13<sup>th</sup> century in just a slightly altered form (Foy, Sennequier 1989, cat. nos. 69–80, 109–115).

In Koper, a part of a trefoil-shaped rim and a ribbed jug handle was found (Cunja 1996, Pl. 5: 78). A similar ribbed handle was found at Invillino (Bierbrauer 1987, Pl. 157: 23). In Italy jugs with similarly shaped rim appear in the 6<sup>th</sup> and 7<sup>th</sup> century (Sternini 1995, 262, Fig. 20: 53). A comparable rim was found also in layers belonging to the time between 630 and 679 at Sardis (Meyer 1988, 203, Fig. 11: A). At Hemmaberg a rim and two fragments of feet were found which could belong to jugs (Ladstätter 2000, 183). Jugs are not a frequent form in the western Mediterranean after the mid-5<sup>th</sup> century but appear much more often in eastern Mediterranean (Lafli, Gürlér 2010, 442).

### 3.7.5 LAMPS

In Slovenia glass lamps were besides Tonovcov grad (see chapter 3.1.6) found also in the lower church at Kučar (J. Dular, Ciglenečki, A. Dular 1995, Pl. 79: 1), in the area of churches at Ajdovski gradec above Vranje (Vogelpohl 1975, Fig. 27: 40), in Koper (Cunja 1996, Pl. 5: 75–76), Kranj (Sagadin 2004, Fig. 6: 16), and the remains of the presbytery of the church at Šilentabor (Osmuk 1977, Fig. 199: 1–4).

All these are examples of glass lamps with a conical or globular recipient, concave base, and three small handles, type I according to M. Uboldi (Uboldi 1995, 104–108; Isings 134 or 9.2.1. according to I. Lazar; Lazar 2003a, 197–200). We did not find any other contemporary types of lamps (group 9 according to Lazar, types II–V according to Uboldi) at Slovenian sites of the end of the 5<sup>th</sup> and 6<sup>th</sup> century.<sup>3</sup>

<sup>3</sup> Two glass lamps with base knobs, which can be dated to the end of the 5<sup>th</sup> and the first half of the 6<sup>th</sup> century, were found at Ajdovščina near Rodik (Lazar 2003a, 198–200, Fig. 52: 9.3.1.) and in Ljubljana (Plesničar Gec 1981, t. 5 far right). These two sites were abandoned by the mid-5<sup>th</sup> century thus both finds present a special problem. They are discussed elsewhere (Milavec 2011).

5. st. niso pogosta oblika, precej pogosteje se pojavljajo v vzhodnem Sredozemlju (Lafli, Gürler 2010, 442).

### 3.7.5 SVETILKE

V Sloveniji so bile steklene svetilke najdene na Tonovcovem gradu (glej pogl. 3.1.6), v spodnji cerkvi na Kučarju (J. Dular, Ciglencečki, A. Dular 1995, t. 79: 1), na območju cerkva na Ajdovskem gradu nad Vranjem (Vogelpohl 1975, sl. 27: 40), v Kopru (Cunja 1996, t. 5: 75–76), Kranju (Sagadin 2004, sl. 6: 16) in v ostankih prezbiterija cerkvenega objekta na Šilentaboru (Osmuk 1977, sl. 199: 1–4).

V vseh primerih gre za steklene svetilke s koničnim ali kroglastim recipientom, vbočenim dnom in tremi majhnimi ročaji, tipa I po M. Uboldi (Uboldi 1995, 104–108; Isings 134 oz. 9.2.1. po I. Lazar; Lazar 2003a, 197–200). Drugih sočasnih vrst svetilk (skupina 9 po Lazarjevi, tipi II–V po Uboldijevi) na slovenskih najdiščih s konca 5. in 6. st. nismo zasledili.<sup>3</sup>

Svetilke z ročaji so bile najdene na tleh četrte cerkve in zakristije zahodnega cerkvenega kompleksa na Sv. Hemi (Ladstätter 2000, 183, t. 24: 16–17). Avtorica omenja tudi neobjavljene primerke iz cerkvene ladje z Lavanta, škofovske cerkve v Teurniji, vzhodnega kompleksa Sv. Heme in Šenturške gore (Ulrichsberg; Ladstätter 2000, 183, op. 1239). Svetilke z ročaji so bile najdene tudi v cerkveni zgradbi na Invillinu (Bierbrauer 1988, 81, sl. 23: 1,4,7). Na Sv. Hemi in Invillinu so bili najdeni tudi odlomki rahlo vbočenih dnov majhnega premera, ki bi lahko sodili k balzamarijem, lahko pa tudi k drugi obliki svetilk s koničnim recipientom, brez ročajev in z dolgim votlim tulcem, kakršne so uporabljali v visečih lestencih (Bierbrauer 1988, sl. 23: 12; Ladstätter 2000, 183, t. 24: 18–19).

Več sočasnih tipov je bilo znanih tudi iz cerkvenih in bivalnih stavb na Gradini na Jelici v Srbiji, vendar so bili deli svetilk z ročaji najdeni le v cerkvah (Križanac 2009, 272–274, sl. 9).

Steklene svetilke so razprostranjene po vsem Sredozemlju, razvijale pa naj bi se vzporedno s cerkveno arhitekturo. V vzhodnem delu imperija naj bi se pojavile nekoliko prej kot na zahodu, vendar jih pred sredino 4. st. niso široko uporabljali. Na vzhodu so v rabi ostale skoraj do danes. Za ta del imperija je bila prva tipologija narejena že zgodaj (Crowfoot, Harden 1931). V vzhodnem delu se pojavlja tudi več različnih tipov steklenih svetilk kot v zahodnem Sredozemlju (Hadad 1998; Olcay 2001; Czurda-Ruth 2005).

<sup>3</sup> Dve svetilki s čepki na dnu, ki ju lahko datiramo v konec 5. in prvo polovico 6. st., sta bili najdeni na Ajdovščini pri Rodiku (Lazar 2003a, 198–200, sl. 52: 9.3.1.) in v Ljubljani (Plesničar Gec 1981, t. 5 skrajno desno). Ti najdišči pa sta bili opuščeni že do sredine 5. st., zato obe najdbi pomenita poseben problem. Obravnavani sta na drugem mestu (Milavec 2011).

Lamps with handles were found on the ground of the fourth church and the vestry of the western ecclesiastical complex at Hemmaberg (Ladstätter 2000, 183, Pl. 24: 16–17). The author also mentions some unpublished examples from the church nave at Lavant, the episcopal church in Teurnia, eastern complex of Hemmaberg, and Ulrichsberg (Ladstätter 2000, 183, note 1239). Lamps with handles were discovered also in the church at Invillino (Bierbrauer 1988, 81, Fig. 23: 1,4,7). At Hemmaberg and Invillino fragments of slightly concave bases of small diameter were also found and these could belong among balsamaria or among another form of lamps with a conical recipient, without handles and with a long tubular stem, such as were used on hanging chandeliers (Bierbrauer 1988, Fig. 23: 12; Ladstätter 2000, 183, Pl. 24: 18–19).

Several contemporary types were found also in ecclesiastical and dwelling buildings at Gradina on Jelica in Serbia, nevertheless, parts of lamps with handles were discovered only in churches (Križanac 2009, 272–274, Fig. 9).

Glass lamps are distributed along the entire Mediterranean and were supposed to develop parallel to the ecclesiastical architecture. They supposedly appeared slightly sooner in the east than in the west of the Empire but were not widely used before the mid-4<sup>th</sup> century. In the East they had remained in use almost until the present day. The first typology for the eastern part of the Empire was made very early (Crowfoot, Harden 1931). In the eastern part of the Mediterranean a larger number of different types of glass lamps occur than in the western (Hadad 1998; Olcay 2001; Czurda-Ruth 2005).

In the western part glass lamps were used from the second half of the 4<sup>th</sup> to the 8<sup>th</sup> century (Uboldi 1995, 105; Stern 1999, 480, 482; Ferri 2006, 184). Lamps represent the most frequent finds in the early Christian buildings, while later their use supposedly spread from churches to private houses (O’Hea 2007, 236). The most used typological division was made by M. Uboldi (Uboldi 1995).

Unlike oil lamps, glass lamps were filled with water and oil and had a wick, made of plant fibres, attached. Some lamps in the East from the late 5<sup>th</sup> or early 6<sup>th</sup> century onwards have a tube, into which a wick was attached, in others the wick was held in place by a metal holder (Crowfoot, Harden 1931, 201). The water was to contribute to a better effect of the lamp which was thus illuminated entirely and not just its flame. Research has shown that a glass lamp, filled with 350 ml of water and 100 ml of castor oil and with a half a centimetre thick cotton wick shone for 2 hours and 45 minutes. This is just 20 minutes longer but significantly stronger than an oil lamp filled with 50 ml of oil (Uboldi 1995, 93–95; Stern 1999, 479).

Lamps with handles could have been hung individually on chains, while types without handles were inserted into various forms of chandeliers (*corona* or *polycandelon*; Stern 1999, 478–480). Considering the

V zahodnem delu so bile steklene svetilke v rabi od druge polovice 4. do 8. st. (Uboldi 1995, 105; Stern 1999, 480, 482; Ferri 2006, 184). Svetilke so najpogostejše najdbe v zgodnjekrščanskih objektih, pozneje pa naj bi se njihova uporaba po vzoru cerkva razširila tudi v bivalne prostore (O'Hea 2007, 236). Najbolj uporabljano tipološko razdelitev je naredila M. Uboldi (Uboldi 1995).

Za razliko od oljenk so bile steklene svetilke napolnjene z vodo in oljem, vanje pa je bil pritrjen stenj iz rastlinskih vlaken. Nekaterne svetilke na Vzhodu imajo od poznega 5. ali zgodnjega 6. st. dalje dodano cevko, v katero je bil pritrjen stenj, v drugih je stenj držal kovinski držaj (Crowfoot, Harden 1931, 201). Voda naj bi pripomogla k boljšemu učinku svetilke, ki je tako zažarela vsa, ne le njen plamen. Raziskave so pokazale, da je steklena svetilka, napolnjena s 350 ml vode in 100 ml ricinovega olja ter s pol centimetra debelim bombažnim stenjem svetila 2 uri in 45 minut. To je samo 20 minut dlje, vendar je svetila precej močnejše kot oljenka, napolnjena s 50 ml olja (Uboldi 1995, 93–95; Stern 1999, 479).

Svetilke z ročaji so bile lahko obešene posamično na verižicah, tipi svetilk brez ročajev pa so bili vstavljeni v različne vrste lestencev (*corona oz. polycandelon*; Stern 1999, 478–480). Glede na vrsto svetilk, ki je ohranjena v Sloveniji, lahko predvidevamo, da lestencev niso uporabljali, verižice za obešanje pa so bile najdene v cerkvi na Ajdovskem gradu (Vogelpohl 1975, t. 24: 22). Izhajajoč iz upodobitev nekateri avtorji domnevajo, da so se v cerkvah uporabljale drugačne vrste steklenih svetilk kot v bivalnih objektih (Parani 2005, 154–157).

### 3.7.6 BALZAMARIJI

Poleg balzamarijev s Tonovcovega gradu (glej pogl. 3.1.7, 3.3.2, 3.3.3) je bil cevast balzamarij z zoženim spodnjim delom najden tudi v cerkvi na Rifniku (Bolta 1981, t. 19: 49). Odlomek dna je bil najden na Križni gori (Urleb 1974, sl. 153: 7), zgornji del balzamarija s cilindričnim trupom pa med ostanki prezbiterija na Šilentaboru (Osmuk 1977, sl. 190: 5).

V cerkvi na Invillinu je bil prav tako najden spodnji del balzamarija (ali svetilke; Bierbrauer 1988, sl. 23: 12).

Kadar niso najdeni v dobro določljivih kontekstih, je balzamarije težko dobro opredeliti in ločiti od najdb, ki spadajo v starejša obdobja. V pozni antiki se ne pojavljajo tako pogosto kot prej, posamezni kosi se ne oblikovno zelo različni, obenem pa se le malo razlikujejo od balzamarijev iz 1. in 2. st. Velikokrat obdržijo navznoter zapognjene rob ustja in jih od starejših ločimo le po značilnostih steklene mase (Meyer 1988, 197–198). Za Italijo so v 6. in 7. st. značilni preprosti hruškasti ali vrečasti primerki (Sternini 1995, 262, sl. 20: 60), v južni Franciji in severni Afriki pa so balzamariji redkejši (glavni pregledi [Foy 1995; Fünfschilling 2006; 2010] jih praktično ne omenjajo). V vsem Sredozemlju so jih

form preserved in Slovenia we can assume that chandeliers were not used, while some hanging chains were found in the church at Ajdovski gradec (Vogelpohl 1975, Pl. 24: 22). Deriving from the depictions some authors assume that different types of glass lamps were used in churches than in houses (Parani 2005, 154–157).

### 3.7.6 BALSAMARIA

Besides the balsamaria from Tonovcov grad (see chapters 3.1.7, 3.3.2, 3.3.3) a tubular balsamarium with a narrowed lower part was also found in the church at Rifnik (Bolta 1981, Pl. 19: 49). A base fragment was discovered at Križna gora (Urleb 1974, Fig. 153: 7) and the upper part of a balsamarium with a cylindrical body among the presbytery remains at Šilentabor (Osmuk 1977, Fig. 190: 5).

The lower part of a balsamarium (or a lamp; Bierbrauer 1988, Fig. 23: 12) was discovered also in the church at Invillino.

When they are not found in well defined contexts, balsamaria are difficult to classify and distinguish from those finds belonging to earlier periods. In Late Antiquity they do not appear as often as before, individual pieces are formally very different from each other and at the same time not much different from balsamaria of the 1<sup>st</sup> and 2<sup>nd</sup> centuries. Often they retain the inward folded rim and can be separated from the earlier ones solely by characteristics of the glass mass (Meyer 1988, 197–198). In the 6<sup>th</sup> and 7<sup>th</sup> century simple pear- or pouch-shaped examples are characteristic for Italy (Sternini 1995, 262, Fig. 20: 60), while balsamaria are rare in southern France and in northern Africa (the main overviews [Foy 1995; Fünfschilling 2006; 2010] hardly mention them). All over the Mediterranean they were most probably used primarily in liturgy (Foy, Nenna 2001, 149–152, 157; Antonaras 2007, 54). Balsamaria and smaller bottles could have been used as reliquaries, as vessels for incense or oil, or for wine or perfumes. In the East a habit is attested for the pilgrims to return home with oil from the lamps which were lit close to very sacred relics (Olcay 2001, 79; Antonaras 2007, 54).

### 3.7.7 OPEN FORMS

Two bowls were found in churches at Ajdovski gradec above Vranje (Vogelpohl 1975, Fig. 31: 27,44). The first one has a downward folded rim, while the other is decorated by a cut ornament representing one of the favourite ways of decorating luxurious vessels until the 5<sup>th</sup> century (Sagui 1993, 122–126). We can assume that the two vessels from Vranje were made before the mid-5<sup>th</sup> century, used in liturgy and remained in use for the entire 5<sup>th</sup> or even the 6<sup>th</sup> century.

najverjetneje uporabljali predvsem v liturgične namene (Foy, Nenna 2001, 149–152, 157; Antonaras 2007, 54). Balzamariji in manjše stekleničke so lahko služili kot relikviariji, kot posodice za kadilo ali olje, pa tudi vino ali dišave. Na Vzhodu je izpričana navada romarjev, da so se vračali domov z oljem svetilk, ki so svetile zraven zelo svetih relikvij (Olcaý 2001, 79; Antonaras 2007, 54).

### 3.7.7 ODPRTE OBLIKE

Dve skledi sta bili najdeni v cerkvah na Ajdovskem gradu nad Vranjem (Vogelpohl 1975, sl. 31: 27,44). Prva ima navzdol zavihan rob ustja, druga pa je okrašena z brušenim okrasom, enim od najbolj priljubljenih načinov okraševanja luksuznega posodja do sredine 5. st. (Sagui 1993, 122–126). Predvidevamo lahko, da sta bili posodi z Vranja izdelani pred sredino 5. st., da sta bili v uporabi v liturgiji, in sicer še vse 5. ali celo v 6. st.

Poleg odlomka s Tonovcovega gradu (*t.* 58: 2; glej pogl. 3.1.8) smo v Sloveniji zasledili le še eno nogo domnevnega krožnika v plasteh pristaniškega kompleksa v Fizinah pri Portorožu (Gaspari et al. 2007, 178–179, t. 7: 209), ki so datirane od druge polovice 4. do 6. st. (Gaspari et al. 2007, 170). Krožnik lahko uvrstimo v tip 10c po D. Foy, ki je datiran v pozno 5. in zgodnje 6. st. (Foy 1995, 205).

V istih plasteh je bil v Fizinah najden tudi odlomek sklede ali krožnika z navzdol zavihanim robom (Gaspari et al. 2007, t. 7: 204), kakršni se pojavljajo predvsem v 5., pa tudi še v 6.–7. st. (Sagui 1993, 121, sl. 6; Sternini 1995, 258, 262).

Odrpte oblike steklenega posodja postajajo redke že od 4. st. naprej, po sredini 5. st. pa skoraj popolnoma izginejo. Nekoliko pogostejše so v vzhodnem Sredozemlju (Stern 1999, 484).

### 3.7.8 DRUGE OBLIKE

Stekleni pivski rog z okrasom iz nataljenih niti je bil najden na kranjskem grobišču Lajh (Stare 1980, t. 131: 1; Lazar 2003a, 203). Spada med značilne germanske najdbe, izdelovali pa naj bi jih v Porenju. Po tipologiji V. Evison spada v skupino III, ki je datirana med sredino 6. in začetek 7. st. (Evison 1975, 79–80).

### 3.7.9 OKENSKO STEKLO

Poleg uporabe v cerkvah na Tonovcovem gradu (glej pogl. 3.5, sl. 3.3) je v Sloveniji dokazana uporaba okenskega stekla tudi na Ajdovskem gradu nad Vranjem (cerkve: Knific, Sagadin 1991, 52; Knific 2001, kat. 152), Korinjskem hribu (Ciglencečki 1985, 265), v Koprju (Cunja 1996, 82–83, t. 5: 82–85) in Kranju (Sagadin 2004, sl. 6: 19,20).

In Slovenia, besides the fragment from Tonovcov grad (*Pl.* 58: 2; see chapter 3.1.8) we could only find one other foot probably of a plate and it was found in the layers of the port complex at Fazine near Portorož (Gaspari et al. 2007, 178–179, Pl. 7: 209), which are dated from the second half of the 4<sup>th</sup> to the 6<sup>th</sup> century (Gaspari et al. 2007, 170). The plate can be assigned to type 10c according to D. Foy, which is dated to the late 5<sup>th</sup> and early 6<sup>th</sup> century (Foy 1995, 205).

In the same layers at Fazine a fragment of a bowl or a plate with a downward folded edge (Gaspari et al. 2007, Pl. 7: 204), such as appear mostly in the 5<sup>th</sup> and also during the 6<sup>th</sup>–7<sup>th</sup> century (Sagui 1993, 121, Fig. 6; Sternini 1995, 258, 262), was also found.

Open forms of glass vessels are becoming rare from the 4<sup>th</sup> century onwards and almost completely disappear after the middle of the 5<sup>th</sup> century. They are slightly more frequent in the eastern Mediterranean (Stern 1999, 484).

### 3.7.8 OTHER FORMS

A glass drinking horn with the decoration of trailed threads was found at the Kranj cemetery Lajh (Stare 1980, Pl. 131: 1; Lazar 2003a, 203). It belongs among typical Germanic finds, which were supposedly made in the Rhine region. According to the typology of V. Evison it belongs to group III, which is dated between the mid-6<sup>th</sup> and the beginning of the 7<sup>th</sup> century (Evison 1975, 79–80).

### 3.7.9 WINDOW GLASS

In Slovenia the use of window glass has been proven besides the churches at Tonovcov grad (see chapter 3.5, Fig. 3.3) also at Ajdovski gradec above Vranje (churches: Knific, Sagadin 1991, 52; Knific 2001, cat. no. 152), Korinjski hrib (Ciglencečki 1985, 265), in Koper (Cunja 1996, 82–83, Pl. 5: 82–85) and Kranj (Sagadin 2004, Fig. 6: 19–20).

The distribution of window glass remains in the west ecclesiastical complex of Hemmaberg reveals that both apses, the northern side wing of the fifth and the vestry of the fourth church were glazed (Ladstätter 2000, 184–185, Fig. 69). Windows of other buildings were not glazed. Window glass was discovered also in naves and apses of other churches in Austria (Teurnia, Lavant, Duell, Laubendorf; Ladstätter 2000, note 1244). Pieces of window glass were found in the church nave at Invillino (Bierbrauer 1988, 41) and also on the settlement plateau at Colle Santino (Bierbrauer 1987, 285). Large amounts of window glass were discovered in the churches of the Byzantine hilltop settlement Gradina on Jelica in Serbia (Križanac 2009). Window glass was also present mostly

Razporeditev ostankov okenskega stekla v zahodnem kompleksu cerkva Sv. Heme kaže, da so bili zastekljeni obe apsidi, severno stransko krilo pete in zakristija četrte cerkve (Ladstätter 2000, 184–185, sl. 69). Druge stavbe niso imele zastekljenih oken. Okensko steklo je bilo najdeno tudi v ladjah in apsidah drugih cerkva v Avstriji (Teurnija, Lavant, Duel, Laubendorf; Ladstätter 2000, op. 1244). Kosi okenskega stekla so bili odkriti še v cerkveni ladji na Invillinu (Bierbrauer 1988, 41), pa tudi na naselbinskem platoju na Colle Santino (Bierbrauer 1987, 285). Velike količine okenskega stekla so bile najdene tudi v cerkvah na bizantinski višinski postojanki Gradina na Jelici v Srbiji (Križanac 2009). Prav tako je bilo okensko steklo najdeno predvsem v baziliki v utrdbi na Vrsenicah (Stamenkovič 2009, 192–194, t. II).

Na območju jugovzhodnih Alp je okensko steklo v večjih količinah najdeno le v ruševinah cerkvenih stavb (glej zgoraj), pri opredelitvi nekaj odlomkov, najdenih ob bivalnih prostorih, pa je interpretacija negotova (na primer stavba 1 na Tonovcovem gradu, glej pogl. 3.5, sl. 3.4). V vzhodnem Sredozemlju so okensko steklo uporabljali v cerkvenih in bivalnih prostorih.

Okensko steklo naj bi se v zgodnji antiki uporabljalo le v kopališčih, kjer je ob hkratnem prepuščanju svetlobe pomagalo ohranjati stalno temperaturo in vlago v prostorih. Od 4. st. dalje so začeli steklena okna vgrajevati v cerkvene objekte (skupaj z uporabo nove oblike steklenega posodja – svetilk), postopno pa tudi v bivalne objekte (O’Hea 2007, 233, 236).

V antiki so uporabljali tri tehnike izdelave okenskega stekla: ulivanje v kalupe, pihane okrogle plošče ali “crown glass” in cilindrično pihano okensko steklo.

Ulivano okensko steklo so naredili tako, da so tekočo stekleno maso ulili v enodelne kalupe in ohladili. Za izdelke je značilno, da je ena površina gladka, druga pa hrapava.

Okrogle okenske plošče so izdelovali tako, da so napihani stekleni krogli odrezali zgornji del in jo razvrteli v okroglo ploščo, kot bi delali krožnik. Na koncu je bila plošča prosojna in gladka, s tankimi (lahko zavihanimi) robovi in debelejším, rahlo izbočenim srednjim delom. Tehnika je bila v rabi od 4. do 19. st.

Cilindrično steklo se je uporabljalo od 1. do 19. st. Stekleno maso so napihali v votlo jajčasto obliko, jo odrezali s pipe, da je nastal cilindar, in ga nato prerezali po dolgem v ploščo. To vrsto okenskega stekla je lahko prepoznati po vzporednih vrstah razpotegnjenih zračnih mehurčkov in po tem, da je ena površina svetleča, tista, ki so jo položili na podlago, pa mat. Ta tehnika je omogočala izdelavo večjih in gladkejših steklenih plošč kot tehnika ulivanja. V večjih steklarskih središčih so uporabljali več tehnik naenkrat, predvsem sta se tudi glede na modo izmenjevala tehnika okroglih steklenih plošč in cilindrično steklo (O’Hea 2007, 234; Kanyak 2009).

in the basilica of the fort at Vrsenice (Stamenkovič 2009, 192–194, Pl. II).

In the area of Southeastern Alps window glass was in greater quantities found only in the ruins of ecclesiastical buildings (see above), while the interpretation of a few fragments discovered near the dwelling houses is uncertain (for example, building 1 at Tonovcov grad, see chapter 3.5, Fig. 3.4). In the eastern Mediterranean window glass was used in ecclesiastical and dwelling buildings.

Window glass was during early Antiquity supposedly used only in baths where beside lighting it also aided in preserving the constant temperature and moisture within a room. From the 4<sup>th</sup> century onwards glazed windows started to be immured into ecclesiastical buildings (together with the use of a new form of glass vessels – lamps) and gradually also into private houses (O’Hea 2007, 233, 236).

Three techniques of window glass production were used in the Antiquity: mould casting, crown glass, and cylinder blown window glass.

Mould cast window glass was made by pouring the liquid glass mass into single part open moulds and left to cool. These products are characterised by one smooth and one rough surface.

Round window plates were made by cutting off the upper part of a blown glass ball and then turning it out into a round plate as if making a plate. Finally the plate is transparent and smooth, with thin (sometimes rolled up) edges and a thicker, slightly convex middle part. This technique was in use from the 4<sup>th</sup> to the 19<sup>th</sup> century.

Cylinder blown glass was used from the 1<sup>st</sup> to the 19<sup>th</sup> century. The glass mass was blown into a hollow oval shape, cut from the blowpipe to form a cylinder which was then cut lengthwise into a plate. This type of window glass is easily recognisable for its elongated air bubbles arranged in parallel lines and also by the fact that one surface is shiny while the other, the one facing the base, is matt. This technique enabled the manufacturing of bigger and smoother glass plates than the technique of mould casting. Bigger glass-making centres used more than one technique at the time, also according to fashion the techniques of round glass plates and cylindrical glass were exchanged (O’Hea 2007, 234; Kanyak 2009).

### 3.7.10 WORKSHOPS

In Kranj, near the Kieselstein castle two plastered pits dug into clay with a fire-place and a platform in between, which was hardened by mortar, were found. A little way off a shallow pool with lime and remains of shells was discovered. The complex was on the basis of small finds, stemmed goblets deformed by the fire and pottery, dated to the beginning of the 6<sup>th</sup> century and interpreted as a glass-making workshop with a manufacturing and cooling furnace (Sagadin 2000; 2004). The site has still not

## 3.7.10 DELAVNICE

V Kranju sta bili ob gradu Kieselstein odkriti dve v glino vkopani ometani jami, s kuriščem in vmesno ploščadjo, utrjeno z malto. Malo stran je bil najden še plitev bazen z apnencem in ostanki školjk. Kompleks je bil s pomočjo drobnih najdb, od ognja deformiranih kozarcev na visoki nogi in keramike, datiran v začetek 6. st. in interpretiran kot steklarska delavnica s pečjo za proizvodnjo in pečjo za ohlajanje (Sagadin 2000; 2004). Najdišče sicer še ni bilo objavljeno v celoti, na osnovi dostopnih informacij pa I. Lazar dvomi o pravilnosti interpretacije. Po njenem mnenju se opisani peči po obliki in značilnostih zelo razlikujeta od običajnih rimskodobnih steklarskih obratov, problematično pa je tudi pomanjkanje odpadkov, ki nastajajo med proizvodnjo, ter kosov surovega stekla. Deformirani kozarci na nogi so bili lahko tudi sekundarno preoblikovani v ognju, najdba srednjeveške steklene posode med gradivom pa predstavlja še dodaten problem pri časovni opredelitvi (Lazar 2003a, 217–218; 2003b, 78–79).

Drugih podatkov o izdelavi posodja na poznoantičnih najdiščih v Sloveniji trenutno nimamo. V Kopru, Kranju in na Tonovcovem gradu, kjer so bile najdene večje količine kozarcev na nogi (glej pogl. 3.7.2), opazamo, da so kozarci na posameznem najdišču dokaj enotnih oblik, med najdišči pa se značilne oblike razlikujejo. Za Kranj so tako na primer značilnejši zvončasti recipienti (sl. 3.7: 1,5), za Tonovcov grad pa cilindrični (npr. t. 54: 7–15,17–18,20–26). To bi lahko dokazovalo obstoj več manjših lokalnih delavnic tudi na slovenskem ozemlju.

V naselbini in cerkvenem središču iz 5. in 6. st. na Sv. Hemi na Koroškem so v plasteh pod zahodnim cerkvenim sklopom našli kose surovega stekla in modre steklene paste. S. Ladstätter meni, da bi glede na te najdbe in ostanke proizvodnje kovinskih predmetov v istih plasteh pred izgradnjo cerkva tam lahko stal prostor z delavnicami, tudi steklenih posod. Poleg tega je bil depo kosov surovega stekla najden tudi na območju vzhodnega cerkvenega kompleksa na Sv. Hemi (Ladstätter 2000, 179, 185). Tudi v poznoantični naselbini Kappele pri Jadersdorfu je bil najden kos surovega stekla (Felgenhauer-Schmiedt 1993, 33–34).

V bizantinski utrdbi Gradina na Jelici je bil najden le en kos steklene žindre, vendar avtorica objave glede na velike količine okenskega stekla in steklenih posod sklepa, da bi lahko šlo za lokalno produkcijo. Omenja tudi nedavno najdbo posode za taljenje steklene mase s Caričinega gradu (Križanac 2009, 267, 277–278).

Dokazi za izdelavo stekla na Invillinu (Bierbrauer 1987, 285–286) sicer še niso prepričali vseh raziskovalcev (Sternini 1995, 268). V Italiji in Franciji naj bi v poznoantičnem času zraslo več manjših delavnic, ki so oskrbovale bližnje naselbine (Sternini 1995, 267–268; Trento: Cavada, Endrizzi 1998; Brescia: Uboldi 1998, 183–184). V vzhodnem Sredozemlju naj bi v poznoan-

been published entirely but I. Lazar doubted the accuracy of the interpretation already on the basis of the available information. According to her, the described furnaces in form and characteristics differ significantly from the ordinary Roman glass-making workshops, while the lack of waste material occurring during the production and pieces of raw glass are also problematic. Deformed stemmed goblets could have also been secondarily transformed in the fire and the find of a medieval glass vessel among the material represents an additional problem for the time definition (Lazar 2003a, 217–218; 2003b, 78–79).

We currently have no other data regarding the vessel manufacturing at Late Antique sites in Slovenia. In Koper, Kranj, and at Tonovcov grad, where greater amounts of stemmed goblets were found (see chapter 3.7.2), we observe that goblets are at an individual site of quite uniform shapes, while shapes differ among sites. Thus for Kranj, for example, bell-shaped recipients are more characteristic (Fig. 3.7: 1,5), while at Tonovcov grad these are cylindrical (e.g. Pl. 54: 7–15,17–18,20–26). This could indicate the existence of several smaller workshops also in the Slovenian territory.

At the settlement and ecclesiastical centre from the 5<sup>th</sup> and 6<sup>th</sup> centuries at Hemmaberg in Carinthia pieces of raw glass and blue glass paste were found in layers beneath the western ecclesiastical complex. S. Ladstätter believes that considering these finds and the remains of the metal-working in the same layers an area with – also glass-making – workshops could have been built there before the construction of churches. At Hemmaberg a hoard of raw glass pieces was found also in the area of the eastern ecclesiastical complex (Ladstätter 2000, 179, 185). A piece of raw glass was also discovered at the Late Antique settlement Kappele near Jadersdorf (Felgenhauer-Schmiedt 1993, 33–34).

At the Byzantine fort Gradina on Jelica only one piece of glass slag was found but on the basis of a great number of window glass and vessels found the author concludes that we could be dealing with local production. She also mentions a recent find of a crucible from Caričin grad in Serbia (Križanac 2009, 267, 277–278).

Evidence about the glass production at Invillino (Bierbrauer 1987, 285–286) has yet not convinced all the researchers (Sternini 1995, 268). In Italy and France a number of small workshops were supposedly founded in Late Antiquity which supplied the nearby settlements (Sternini 1995, 267–268; Trento: Cavada, Endrizzi 1998; Brescia: Uboldi 1998, 183–184). In the eastern Mediterranean, during Late Antiquity every major settlement was to have its own glass workshop (Lafli, Gürlér 2010, 444).

Until the beginning of the 9<sup>th</sup> century glass mass (the so-called primary glass production) was manufactured solely in the Syrian-Palestinian area and in Egypt (Stern 1999, 454; Freestone et al. 2000; Nenna et al. 2000; Foy, Nenna 2001; Freestone 2005, 196–197). In the



tičnem času vsaka večja naselbina imela svojo steklarsko proizvodnjo (Lafli, Gürler 2010, 444).

Vse do začetka 9. st. so stekleno maso (t. i. primarna produkcija stekla) izdelovali le na sirsko-palestinskem območju ter v Egiptu (Stern 1999, 454; Freestone et al. 2000; Nenna et al. 2000; Foy, Nenna 2001; Freestone 2005, 196–197), za zahodni del imperija primarne delavnice, kljub omembah v pisnih virih, niso dokazane.

Najpogostejša barva steklenega posodja v Sloveniji (Tonovcov grad, Kranj, Koper) je rumenozelena. Nastala je naravno pri izdelavi mase, ki ji niso dodajali barvil. Nekateri avtorji menijo, da je ta barva značilna za stekleno maso tipa HIMT (visoka vsebnost železa, mangana in titana; Reade et al. 2005; Lindblom 2005, 164), drugi pa, da se pojavlja zaradi nižje kakovosti stekla (Uboldi, Verità 2003, 116).

### 3.7.11 SKLEP

Po razcvetu steklarstva v 1. in 2. st. je v zahodnem delu imperija raznolikost oblik posod začela pojemati že v 3. st. (Stern 1999, 480–481; Lazar 2006, 336). Število oblik, ki so bile v poznorimskem obdobju po vsem imperiju zelo enotne, se je v 5. st. še naprej zmanjševalo. Med velikimi političnimi in družbenimi premiki v 5. st. je prišlo tudi do preloma v steklarski tradiciji. Spremenili so se barva, oblike posodja, vrste okrasa in oblikovanost roba ustja. Mogoče je, da so stare delavnice morda prenehale delovati in so bile vzpostavljene nove (Sternini 1995, 258). Po sredini 5. st. so predvsem v zahodnem delu imperija izdelovali le še zelo omejen spekter posod. Steklo se ni več uporabljalo za transport, embalažo in shranjevanje, izginile so skoraj vse odprte oblike namiznega posodja (sklede, krožniki). Ohranile so se predvsem oblike, uporabljane v liturgiji (svetilke, manjše stekleničke), in pivski servis (kozarci, steklenice).

V zgodnjem bizantinskem obdobju, med 5. in sredino 7. st., je bil za vzhodni del imperija značilen nekoliko širši spekter steklenega posodja kot za zahodni del. Pojavljali so se tudi vrči, odprte posode, bolj raznolike so bile svetilke in oblike kozarcev na visoki nogi. Vzhodno steklarstvo je doživelo večjo spremembo šele s prihodom Arabcev v 7. stoletju, ki so steklene oblike deloma prevzeli in razvijali dalje (predvsem svetilke). Oblikovno se je spekter steklenih predmetov v vzhodnem Sredozemlju opazno spremenil v 10. in 11. st. (srednje bizantinsko obdobje), ko so ostale v uporabi praktično le še steklene zapestnice (Lightfoot 2005, 179–181; Lafli, Gürler 2010, 435).

V Italiji in Franciji se je vse do začetka 9. st. nemo-teno nadaljevala kakovostna proizvodnja s sicer ozkim spektrom posod (kozarci na nogi, svetilke, majhne stekleničke, okensko steklo), vendar ponovnim razcvetom okrasa in živih barv stekla (Ferri 2006, 189). Za zarezo v

western part of the Empire, despite references in written sources, there is no evidence of primary workshops.

The most frequent glass vessel colour in Slovenia (Tonovcov grad, Kranj, Koper) is yellow-green. This colour was created naturally during the manufacturing of the mass which was not added colour. Some authors believe that this colour is characteristic for type HIMT glass mass (high content of iron, manganese, and titanium; Reade et al. 2005; Lindblom 2005, 164), while others think that it occurs due to the lower quality of glass (Uboldi, Verità 2003, 116).

### 3.7.11 CONCLUSION

After glass-making had prospered in the 1<sup>st</sup> and 2<sup>nd</sup> century, in the 3<sup>rd</sup> century the number of vessel shapes started to decrease in the western part of the Empire (Stern 1999, 480–481; Lazar 2006, 336). The number of shapes which were in the Late Roman period very uniform in the entire Empire further decreased in the 5<sup>th</sup> century. During great political and social shifts of the 5<sup>th</sup> century, the glass-making tradition also encounters a change. The colour, shapes, decoration types, and rim forms change. It is possible that the old workshops ceased to operate and new ones were created (Sternini 1995, 258). After the middle of the 5<sup>th</sup> century only a very limited range of vessels is produced in the western part of the Empire. Glass is no longer used for transport, packaging, and storage, almost all open forms disappear (bowls, plates). Mostly just those forms that were used in liturgy (lamps, smaller bottles) and drinking sets (goblets, beakers, bottles) were preserved.

For the early Byzantine period, between the 5<sup>th</sup> and the mid-7<sup>th</sup> century, the eastern part of the Empire presents a somewhat wider range of glass vessels than the western part. Jugs and open vessels occur; the diversity of lamps and stemmed goblet shapes is greater. The eastern glass-making experiences the first greater change with the arrival of the Arabs in the 7<sup>th</sup> century who partly take over the glass forms and develop them further (especially lamps). Formally the range of glass objects in the eastern Mediterranean changes noticeably in the 10<sup>th</sup> and 11<sup>th</sup> centuries (Middle Byzantine period) when glass bracelets are practically the only ones still in use (Lightfoot 2005, 179–181; Lafli, Gürler 2010, 435).

In Italy and France a quality production continued undisturbed until the beginning of the 9<sup>th</sup> century which had a narrow range of vessels (stemmed goblets, lamps, small bottles, window glass) but with a rebirth of ornament and vivid glass colours (Ferri 2006, 189). There are several reasons for the break of the 9<sup>th</sup> century in the western Mediterranean. Besides the altered glass-making technology in the entire area there is also the distancing of Italy from Byzantium and the lack of

9. st. je bilo v zahodnem delu Sredozemlja več razlogov, poleg spremenjene tehnologije izdelave stekla na vsem območju tudi odmik Italije od Bizanca ter pomanjkanje najdišč iz tistega obdobja v južni Franciji (Foy 1995, 210–213; Sagui, Mirti 2003). Celinska Francija je vsaj do 9. st. kazala svojske, severnjaške oblike, vendar enako stekleno maso kot Sredozemlje (Périn 1989; Foy 1995, 216). Karolinškodobno steklo je obdržalo oblike merovinškega obdobja, pojavile so se bolj žive barve okrasa in okenskega stekla, opaznih pa je le malo povezav s Sredozemljem (Evison 1989, 138–143). V slovanskih deželah, na primer na Moravskem, so uvažali steklene posode približno med 850 in 950, po tem obdobju pa le še steklene jagode (Sedlačková 2006, 193–195). V Italiji je bila proizvodnja kakovostnega stekla v zgodnjem srednjem veku vezana na samostane (Dell'Acqua 1997; Ferri 2006).

Cerkveno središče Kučar pri Podzemlju je opredeljeno v 5. st. Tam je bilo najdenih nekaj steklenih odlomkov značilnih oblik 4. in začetka 5. st. (odrezano ustje kozarca brez noge, lijakasto ustje steklenice), ne pojavljajo pa se poznejše oblike, na primer kozarci na visoki nogi (J. Dular, Ciglencečki, A. Dular 1995, 146).

V slovenskih poznoantičnih višinskih naselbinah, ki sodijo v drugo polovico 5. in 6. st., se steklo pojavlja v dokaj majhnem številu, vendar v značilnem sredozemskem spektru kozarcev na visoki nogi in kozarcev brez nog, svetilk in posameznih manjših ali večjih stekleničk. Pogosto so na najdiščih prisotne tudi starejše oblike, ki so se lahko uporabljale tudi v poznejšem času. V cerkvenih zgradbah so uporabljali svetilke z ročaji in okensko steklo. Delavnice steklenega posodja na slovenskem prostoru in v bližnji okolici niso z gotovostjo potrjene. Glede na to, da so drugod v Sredozemlju delavnice pogoste in razpršene in glede na najdbe surovega stekla v nekaterih bližnjih naselbinah (Sv. Hema in Kappele na Koroškem) lahko sklepamo, da so vsaj v pomembnejših naselbinah (npr. Kranj) izdelovali tudi stekleno posodje. Oskrba s surovim steklom in organizacija delavnic bi v poznoantičnem času najverjetneje spadala pod okrilje Cerkve. Ta je bila v pozni antiki najmočnejša (na trenutke edina) organizacijska moč v jugovzhodnoalpskem prostoru (Glaser 1997, 45) in obenem velik porabnik steklenih izdelkov (svetilke, kozarci, okensko steklo).

Po pričakovanjih je stekleno posodje bolje zastopano v večjih centrih (Kranj) in na obalnem predelu (Koper), kjer najdemo tudi večjo pestrost oblik. V višinskih naselbinah v notranjosti Slovenije je najdenih manj primerkov, vendar pogosto ni jasno, ali gre pri majhni količini najdenega stekla le za trenutno stanje objavljenosti, ali za dejansko manjšo rabo te vrste posodja. Ker steklo do sedaj ni bilo deležno velike pozornosti (sploh okensko), se zdi, da je verjetnejša prva razlaga.

Uporaba stekla po koncu 6. st. na prostoru današnje Slovenije in širšega prostora, kamor so se naselili

sites from this period in southern France (Foy 1995, 210–213; Sagui, Mirti 2003). Continental France shows peculiar, northern forms, yet the same glass mass as the Mediterranean, at least until the 9<sup>th</sup> century (Périn 1989; Foy 1995, 216). Glass of the Carolingian period retains forms of the Merovingian period, intenser colours of the decoration and window glass appear, noticeable connections with the Mediterranean are few (Evison 1989, 138–143). In Slavic lands, for example Moravia, import of glass vessels is present between approximately 850 and 950, after this period only glass beads are still imported (Sedlačková 2006, 193–195). In Italy, the production of quality glass is during the Early Middle Ages linked to monasteries (Dell'Acqua 1997; Ferri 2006).

The ecclesiastical centre Kučar near Podzemelj is dated to the 5<sup>th</sup> century. Some fragments of glass vessels, typical of the 4<sup>th</sup> and the beginning of the 5<sup>th</sup> century were found there, but no later forms such as stemmed goblets (J. Dular, Ciglencečki, A. Dular 1995, 146).

At the Slovenian Late Antique hilltop settlements belonging to the 5<sup>th</sup> and 6<sup>th</sup> centuries glass appears in fairly small numbers, yet in the typical Mediterranean range of stemmed goblets and beakers, lamps, and individual smaller or bigger bottles. Often sites also reveal older forms which could have been used at a later time. In ecclesiastical buildings lamps with handles and window glass were used. Workshops making glass vessels are not confirmed with certainty at the Slovenian territory and its near surroundings. Considering the fact that elsewhere in the Mediterranean glass workshops are frequent and dispersed, we can, on the basis of raw glass finds at several nearby settlements (Hemmaberg and Kappele in Carinthia), assume that in at least the more important settlements (e.g. Kranj) glass vessels were made. The supply of raw glass and the functioning of workshops would in the Late Antiquity most probably be under the supervision of the Church, which was in the Late Antiquity the strongest (occasionally the only) organisational power in the southeastern Alpine territory (Glaser 1997, 45) and simultaneously a great consumer of glass products (lamps, goblets, window glass).

According to the expectations, glass vessels are more numerous in bigger centres (Kranj) and in the coastal area (Koper), where we also encounter a wider selection of forms. At hilltop settlements in central Slovenia fewer examples were found, yet it is often not clear whether this small amount of discovered glass is the consequence of the present state of publications or these types of vessels were actually less often used. Since glass so far did not receive any special attention (especially window glass) the first explanation seems more probable.

The use of glass after the end of the 6<sup>th</sup> century in the area of present-day Slovenia and wider territory settled by the Slavic peoples, is still poorly known (Šmit

Slovani, je še slabo poznana (Šmit et al. 2009; Šmit et al. 2010). Med 8. in 9. st. so najverjetneje datirani kozarci koprške 4. skupine z visoko votlo nogo z odebelitvijo (sl. 3.6: 3; Cunja 1996, 74, 77–78). Najdišče, ki si zasluži pozornost, je Sv. Pavel nad Vrtovinom, kjer sta bili poleg dveh značilnih visokih votlih nog kozarcev najdeni tudi dve redki obliki, polna noga s svitkasto odebelitvijo in votla noga z odebelitvijo (sl. 3.8), ki povsem spominja na noge kozarcev koprške 4. skupine (Svoljšak 1985, t. 2: 38; 4: 74).

et al. 2009; Šmit et al. 2010). Goblets of the 4<sup>th</sup> Koper group with a hollow stem with a knob most probably belong between the 8<sup>th</sup> and 9<sup>th</sup> century (Fig. 3.6: 3; Cunja 1996, 74, 77–78). The site deserving special attention is Sv. Pavel above Vrtovin where besides two typical hollow stems of goblets also two rare forms were found, i.e. a full stem with a coil-shaped knob and a hollow stem with a globular knob (Fig. 3.8) which completely resembles goblet stems of the 4<sup>th</sup> Koper group (Svoljšak 1985, Pls. 2: 38; 4: 74).

### 3.8 LITERATURA / BIBLIOGRAPHY

Tonovcov grad. Naselbinski ostanki in interpretacija / Tonovcov grad. Settlement remains and interpretation = Ciglencečki, Modrijan, Milavec 2011.

ANTONARAS, A. 2007, Early Christian Glass Finds from the Museum Basilica, Philippi. – *Journal of Glass Studies* 49, 47–56.

ARLETTI, R., C. GIACOBBE, S. QUARTIERI, G. SABATINO, G. TIGNANO, M. TRISCARI in / and G. VEZZALINI 2010, Archaeometrical investigation of Sicilian Early Byzantine glass: chemical and spectroscopic data. – *Archaeometry* 52/1, 99–114.

ATIK, S. 2009, Late Roman/Early Byzantine Glass from the Marmaray Rescue Excavations at Yenikapi in Istanbul. – V / In: E. Laffi (ur. / ed.), *Late Antique/Early Byzantine Glass in the Eastern Mediterranean*, Congressus Internationales Smyrnenses II, Dokuz Eylül University Faculty of Arts Department of Archaeology Division for Medieval Archaeology Publication Series, No. 1, 1–16, Izmir.

BALDONI, D. in / and F. BERTI 1998, Il vetro di Iasos (Caria) nel quadro delle produzioni nel Mediterraneo orientale. – V / In: *Il vetro dall'antichità all'età contemporanea: aspetti tecnologici, funzionali e commerciali*, 73–85, Milano.

BAVEC, U. 2003, Predhodno poročilo o poznoantičnem grobišču na Vrajku v Gorenjem Mokronogu (Preliminary report on the the Late Roman cemetery at Vrajk in Gorenji Mokronog). – *Arheološki vestnik* 54, 325–330.

BELOŠEVIĆ, J. 1980, *Materijalna kultura Hrvata od VII do IX stoljeća*. – Zagreb.

BIERBRAUER, V. 1987, *Invillino–Ibligo in Friaul 1. Die römische Siedlung und das spätantik-frühmittelalterliche Castrum*. – Münchner Beiträge zur Vor- und Frühgeschichte 33.

BIERBRAUER, V. 1988, *Invillino–Ibligo in Friaul II. Die spätantiken und frühmittelalterlichen Kirchen*. – Münchner Beiträge zur Vor- und Frühgeschichte 34.

BITENC, P. in / and T. KNIFIC 2001, *Od Rimljanov do Slovanov. Predmeti*. – Ljubljana.

BOLTA, A. 1981, *Rifnik pri Šentjurju. Poznoantična naselbina in grobišče*. – Katalogi in monografije 19.

BOŽIČ, D. in / and S. CIGLENEČKI, 1995, Zenonov tremis in poznoantična utrdba Gradec pri Veliki Strmici / Der Tremis des Kaisers Zeno und die spätrömische Befestigung Gradec bei Velika Strmica – *Arheološki vestnik* 46, 247–277.

BUORA, M. 1998, La circolazione vetraria nell'Italia nordorientale nel periodo tardoantico e la produzione di un maestro vetraio a Sevegliano. – V / In: *Il vetro dall'antichità all'età contemporanea: aspetti tecnologici, funzionali e commerciali*, 165–172, Milano.

CALVI, M. C. 1969, *I vetri romani*. – Pubblicazioni dell'associazione nazionale per Aquileia 8.

CAVADA, E. in / and L. ENDRIZZI 1998, Produrre vetro a Trento. Primi indizi nei livelli tardoantichi e alto-medievali dell'area urbana. – V / In: *Il vetro dall'antichità all'età contemporanea: aspetti tecnologici, funzionali e commerciali*, 173–179, Milano.

ÇELIK, U. İ. 2009, Glass from the 2006 Excavation Season in the Theatre at Nicaea. – V / In: E. Laffi (ur. / ed.), *Late Antique / Early Byzantine Glass in the Eastern Mediterranean*, Congressus Internationales Smyrnenses II, Dokuz Eylül University Faculty of Arts Department of Archaeology Division for Medieval Archaeology Publication Series, No. 1, 151–160, Izmir.

CIGLENEČKI, S. 1985, Potek alternativne ceste Siscija–Akvileja na prostoru zahodne Dolenjske in Notranjske v času 4. do 6. stoletja (Der Verlauf der Alternativstrasse Siscia–Aquileia im Raum von Westdolenjsko und Notranjsko in der Zeitspanne vom 4. bis zum 6. Jh.). – *Arheološki vestnik* 36, 255–284.

CIGLENEČKI, S. 2000, *Tinje nad Loko pri Žusmu. Poznoantična in zgodnjerednjevska naselbina / Tinje oberhalb von Loka pri Žusmu. Spätantike und frühmittelalterliche Siedlung*. – Opera Instituti Archaeologici Sloveniae 4.

CIGLENEČKI, S. 2003, Frühchristliche Kirchen in Slowenien und die Elemente ihrer Innenausstattung. – *Hortus Artium Medievalium* 9, 11–20.

CIGLENEČKI, S., Z. MODRIJAN in / and T. MILAVEC 2011, *Poznoantična naselbina Tonovcov grad pri Kobaridu. Naselbinske najdbe in interpretacija / Late Antique fortified settlement Tonovcov grad near Kobarid. Settlement remains and interpretation.* – Opera Instituti Archaeologici 23.

CIGLENEČKI, S. in / and D. PIRKMAJER 1987, Zatočišče poslednjih Celejanov na Vipoti (Die Zufluchtsort der letzten Celeianer auf der Vipota) – *Arheološki vestnik* 38, 217–236.

CROWFOOT, G. M. in / and D. B. HARDEN 1931, Early Byzantine and Later Glass Lamps. – *Journal of Egyptian Archaeology* 17, 196–208.

CUNJA, R. 1989, *Koper med Rimom in Benetkami. Izkopavanja na vrtu kapucinskega samostana / Capodistria tra Roma e Venezia. Gli scavi nel convento dei Cappuccini.* – Piran.

CUNJA, R. 1996, *Poznoantični in srednjeveški Koper. Arheološka izkopavanja na bivšem Kapucinskem vrtu v letih 1986–1987 v luči drobnih najdb od 5. do 9. stoletja / Capodistria tardoromana e altomedievale. Lo scavo archeologico nell'ex orto dei Cappuccini negli anni 1986–1987 alla luce dei reperti dal V al IX secolo d. C.* – Koper.

CZURDA-RUTH, B. 2005, Glas aus Ephesos: Hanghaus 1 und eine Werkstätte des 6. Jahrhunderts n. Chr. auf der Agora. – V / In: *Annales du 16e congrès de l'Association Internationale pour l'Histoire du Verre*, 158–161, London.

DELL'ACQUA, F. 1997, Ninth century window glass from the monastery of San Vincenzo al Volturno (Molise, Italy). – *Journal of Glass Studies* 39, 33–41.

DULAR, J., S. CIGLENEČKI in / and A. DULAR 1995, *Kučar. Železnodobno naselje in zgodnjekrščanski stavbni kompleks na Kučarju pri Podzemlju / Kučar. Eisenzeitliche Siedlung und frühchristlicher gebäudekomplex auf dem Kučar bei Podzemelj.* – Opera Instituti Archaeologici Sloveniae 4.

DUSSART, O., B. VELDE, P.-M. BLANC in / and J. P. SODINI 2004, Glass from Qual'at Sem'an (Northern Syria): The Reworking of Glass during the transition from Roman to Islamic Compositions. – *Journal of Glass Studies* 46, 67–83.

EVISON, V. 1975, Germanic Glass Drinking Horns. – *Journal of glass studies* 17, 74–87.

EVISON, V. 1989, Le verre carolingien. – V / In: D. Foy, G. S. Sennequier (ur. / eds.), *À travers le verre: du moyen âge à la renaissance*, 137–144, Rouen.

FADIĆ, I. 1994, Kasnoantičko staklo u Gatima. – V / In: *Gata. Crkva Justinijanova doba / A church from Justinian's time*, 213–226. – Split.

FELGENHAUER-SCHMIEDT, S. 1993, *Das Kappele ("Die Kåpile") ob Jadersdorf.* – Aus Forschung und Kunst 27.

FERRI, M. 2006, Reperti vitrei altomedievali dagli scavi di Torcello e San Francesco dal Deserto– Venezia. – *Journal of Glass Studies* 48, 173–189.

FOY, D. 1995, La verre de la fin du IVE au VIIIe siècle en France Méditerranéenne. Premier essai de typo–chronologie. – V / In: D. Foy (ur. / ed.), *Le verre de l'Antiquité tardive et du Haut Moyen Âge. Typologie–Chronologie–Diffusion*, 187–380, Guiry en Vexin.

FOY, D. in / and M.-D. NENNA (ur. / eds.) 2001, *Tout feu tout sable. Mille ans de verre antique dans le Midi de la France.* – Aix-en-Provence.

FOY, D., M. PICON, M. VICHY in / and V. THIRION-MERLE 2003, Caractérisation des verres de la fin de l'Antiquité en Méditerranée occidentale: l'émergence de nouveaux courants commerciaux. – V / In: D. Foy (ur. / ed.), *Échanges et commerce du verre dans le monde antique*, Monographies Instrumentum 24, 41–86, Montagnac.

FOY, D. in / and G. SENNEQUIER (ur. / eds.) 1989, *À travers le verre: du moyen âge à la renaissance.* – Rouen.

FREESTONE, I. C. 2005, The Provenance of Ancient Glass through Compositional Analyses. – *Materials Research Society Symposium Proceedings* Vol. 852, 195–208.

FREESTONE, I. C., Y. GORIN-ROSEN in / and M. J. HUGHES 2000, Primary glass from Israel and the production of glass in Late Antiquity and the Early Islamic period. – V / In: M.-D. Nenna (ur. / ed.), *La route du verre. Ateliers primaires et secondaires du second millénaire av. J. C. au Moyen Âge*, Travaux de la Maison de l'Orient Méditerranéen 33, 65–83, Lyon.

FOY, D. in / and G. SENNEQUIER (ur. / ed.) 1989, *À travers le verre: du moyen âge à la renaissance.* – Rouen.

FÜNFSCILLING, S. 2006, Special relationship between the glass finds from Carthage and Rome and comparisons with finds north of the Alps. – V / In: *Annales du 17e Congrès de l'Association pour l'histoire du verre*, 143–149, Antwerp.

FÜNFSCILLING, S. 2010, Byzantine glass finds from Carthage: from the German excavations, the English excavations at Bir Messaouda and from the Canadian excavations. V / In: J. Drauschke, D. Keller (ur. / eds.), *Glass in Byzantium – production, usage, analyses*, RGZM Tagungen 8, 215–224, Mainz.

GASPARI, A., V. VIDRIH-PERKO, M. ŠTRAJHAR in / and I. LAZAR 2007, Antični pristaniški kompleks v Fizinah pri Portorožu – zaščitne raziskave leta 1998 / The Roman port complex at Fizine near Portorož – rescue excavations in 1998. – *Arheološki vestnik* 58, 167–218.

GLASER, F. 1997, *Frühes Christentum im Alpenraum: eine archäologische Entdeckungsreise.* – Graz, Wien, Köln.

HADAD, S. 1998, Glass lamps from the Byzantine through Mamluk periods at Bet Shean, Israel. – *Journal of Glass Studies* 40, 63–76.

HARDEN, D. B. 1936, *Roman Glass from Karanis.* – Oxford.

HAYES, J. W. 1975, *Roman and Pre-Roman Glass in the Royal Ontario Museum. A Catalogue.* – Toronto.

ISINGS, C. 1957, *Roman glass from dated finds*. – *Archaeologia Traiectina* II.

KANYAK, S. 2009, Late Antique/Early Byzantine Window Glass from the Marmaray Rescue Excavations at Sirkeci, Istanbul. – V / In: E. Laflı (ur. / ed.), *Late Antique/Early Byzantine Glass in the Eastern Mediterranean*, Congressus Internationales Smyrnenses II, Dokuz Eylül University Faculty of Arts Department of Archaeology Division for Medieval Archaeology Publication Series, No. 1, 25–47, Izmir.

KNIFIC, T. 1979, Vranje pri Sevnici. Drobne najdbe z Ajdovskega gradca (Vranje bei Sevnica. Kleinfunde aus Ajdovski gradec). – *Arheološki vestnik* 30, 732–785.

KNIFIC, T. 1994, Vranje near Sevnica: A Late Roman Settlement in the Light of Certain Pottery Finds. – *Arheološki vestnik* 45, 211–237.

KNIFIC, T. 2001, [različne kataloške enote / vari-ous cat. nos.]. – V: *Od Rimljanov do Slovanov. Predmeti*. – Ljubljana.

KNIFIC, T. in / and M. SAGADIN, 1991, *Pismo brez pisave. Arheologija o prvih stoletjih krščanstva na Slovenskem*. – Ljubljana.

KRIŽANAC, M. 2009, Glass from Early Byzantine Gradina in Mount Jelica (Serbia). – V / In: E. Laflı (ur. / ed.), *Late Antique / Early Byzantine Glass in the Eastern Mediterranean*, Congressus Internationales Smyrnenses II, Dokuz Eylül University Faculty of Arts Department of Archaeology Division for Medieval Archaeology Publication Series, No. 1, 265–284, Izmir.

LADSTÄTTER, S. 2000, *Die materielle Kultur der Spätantike in der Ostalpen. Eine Fallstudie am Beispiel der westlichen Doppelkirchenanlage auf dem Hemma-berg*. – *Mitteilungen der prähistorischen Kommission* 35.

LAFLI, E. in / and B. GÜRLER 2010, Frühbyzantinische Glaskunst in Kleinasien. – V / In: F. Daim, J. Drauschke (ur. / eds.), *Byzanz – das Römerreich im Mittelalter*. Teil 1. *Welt der Ideen, Welt der Dinge*., 431–449, Bonn.

LAUWERS, V., P. DEGRYSE in / and M. WAELKENS 2007, Evidence for Anatolian Glassworking in Antiquity: The Case of Sagalassos (Southwestern Turkey). – *Journal of Glass Studies* 49 2007, 39–46.

LAZAR, I. 2003a, *Rimsko steklo Slovenije / The Roman glass of Slovenia*. – *Opera Instituti Archaeologici Sloveniae* 7.

LAZAR, I. 2003b, Roman glass production in Slovenia. – In / V: *Annales du 15e Congrès de l'Association Internationale pour l'Histoire du Verre*, 78–81, Nottingham.

LAZAR, I. 2004, Predgovor in pregled raziskav antičnega stekla v Sloveniji / Introduction and survey of research into glass from Antiquity in Slovenia. – V / In: I. Lazar (ur. / ed.), *Drobci antičnega stekla / Fragments of Ancient glass*, 7–10, Ljubljana.

LAZAR, I. 2010, Analize antičnega stekla. Brez pravih vprašanj ni pravih odgovorov. – *Argo* 53/1, 84–86.

LEBEN, F. in / and Z. ŠUBIC, 1990, Poznoantični kastel Vrh Brsta pri Martinj hribu na Logaški planoti (Das spätantike Kastell Vrh Brsta bei Martinj hrib auf dem Karstplateau von Logatec). – *Arheološki vestnik* 41, 313–354.

LEBEN, F. in / and A. VALIČ, 1978, Ajdna nad Potoki. – *Arheološki vestnik* 29, 523–545.

LIGHTFOOT, C. S. 2005, Glass finds at Amorium. – *Dumbarton Oaks Papers* 59, 173–181.

LINDBLOM, J. 2005, Chronological and economic aspect of glass lamps from the Finnish excavations at Jabal Harūn near Petra. – V / In: *Annales du 16e congrès de l'Association Internationale pour l'Histoire du Verre*, 162–166, London.

MARTIN, M. 1992, Volker Bierbrauer, Invillino–Ibligo in Friaul I. Die römische Siedlung und das spätantik–frühmittelalterliche Castrum; Invillino–Ibligo in Friaul II. Die spätantiken und frühmittelalterlichen Kirchen. – *Jahrbuch der Schweizerischen Gesellschaft für Ur- und Frühgeschichte* 75, 260–263.

MENIS, G. C. (ur. / ed.) 1990, *I Longobardi*. – Milano.

MEYER, C. 1988, Glass from the North Theater Byzantine Church and Soundings at Jerash, Jordan, 1982–1983. – *Bulletin of the American Schools of Oriental Research. Supplementary Studies* 25, 175–222.

MILAVEC, T. 2009, 5th–6th Century Glass from the Hilltop Settlement of Tonovcov Grad (Slovenia). – V / In: E. Laflı (ur. / ed.), *Late Antique/Early Byzantine Glass in the Eastern Mediterranean*, Congressus Internationales Smyrnenses II, Dokuz Eylül University Faculty of Arts Department of Archaeology Division for Medieval Archaeology Publication Series, No. 1, 289–304, Izmir.

MILAVEC, T. 2011 A glass lamp with a base knob from Emona. – V / In: *Emona med Akvilejo in Panonijo*. Simpozij v spomin dr. L. Plesničar Gec (v tisku / in print).

NENNA, M.-D., M. PICON in / and M. VICHY 2000, Ateliers primaires et secondaires en Égypte à l'époque gréco-romaine. – V / In: M.-D. Nenna (ur. / ed.), *La route du verre. Ateliers primaires et secondaires du second millénaire av. J. C. au Moyen Âge*, Travaux de la Maison de l'Orient Méditerranéen 33, 97–112, Lyon.

O'HEA, M. 2007, Glass in late Antiquity in the Near East. – V / In: L. Lavan, *Technology in Transition A.D. 300–650*, Late Antique Archaeology 4 – 2006, 233–248, Leiden.

OLCAY, B. Y. 2001, Lighting methods in the Byzantine period and findings of glass lamps in Anatolia. – *Journal of Glass Studies* 44, 77–87.

OSMUK, N. 1977, Šilentabor pri Zagorju v Brkinih. – *Varstvo spomenikov* 21, 321–325.

PARANI, M. G. 2005, Representations of Glass Objects as a Source on Byzantine Glass: How Useful Are They? – *Dumbarton Oaks Papers* 59, 147–171.

PAVLIN, P. in / and J. DULAR 2007, Prazgodovinska višinska naselja v Posavskem hribovju (Prehistoric hilltop settlements in the Posavje Hills). – *Arheološki vestnik* 58, 65–120.

PÄFFGEN, B. 1992, *Die Ausgrabungen in St. Severin zu Köln*. – *Kölner Forschungen* 5,1–3.

PÉRIN, P. 1989, Le verre mérovingien. – V / In: D. Foy, G. S. Sennequier (ur. / eds.), *À travers le verre: du moyen âge à la renaissance*, 125–131, Rouen.

PETRU, P. in / and T. ULBERT, 1975, *Vranje pri Sevnici. Starokrščanske cerkve na Ajdovskem gradcu / Vranje bei Sevnica. Frühchristliche Kirchenanlagen auf dem Ajdovski gradec*. – Katalogi in monografije 12.

PETRU, S. 1975, Das spätantike Glas in Slowenien. – V / In: V. Čubrilović (ur. / ed.), *Srednjovekovno staklo na Balkanu, V–XV. vek / Verre medieval aux Balkans (V<sup>e</sup>–XV<sup>e</sup> s.)*, 5–10, Beograd.

PLESNIČAR GEC, L. 1975, Bicchieri vitrei tar-doantichi di Emona. – V / In: V. Čubrilović (ur. / ed.), *Srednjovekovno staklo na Balkanu / Verre medieval aux Balkans (V<sup>e</sup>–XV<sup>e</sup> s.)*, V–XV. vek, 49–51, Beograd.

PLESNIČAR GEC, L. 1981, The production of glass at Emona. – *Archaeologia Jugoslavica* 21, 136–142.

RAVNIK, M. 2006, *Zaščitne raziskave Ančnikovega gradišča pri Jurišni vasi v letih od 1986–1994*. – Diplom-ska naloga / Undergraduate thesis, Oddelek za arheologijo, Filozofska fakulteta Univerze v Ljubljani, Ljubljana.

READE, W., I. C. FREESTONE in / and St. J. SIMPSON 2005, Innovation or continuity? Early first millennium BCE glass in the Near East: The cobalt blue glasses from Assyrian Nimrud. – V / In: *Annales du 16e congrès de l'Association Internationale pour l'Histoire du Verre*, 23–27, London.

RUŽIĆ, M. 1994, *Rimsko staklo u Srbiji*. – Beograd.

RÜTTI, B. 1991, *Die römischen Gläser aus Augst und Kaiseraugst*. – *Forschungen in Augst* 13.

SAGADIN, M. 2000, Poznoantična steklarska delavnica v Kranju. – V / In: *Kranjski zbornik*, 13–22, Kranj.

SAGADIN, M. 2004, Poznoantična steklarska delavnica (?) v Kranju (A Late Antique glass workshop (?) in Kranj). – V / In: I. Lazar (ur. / ed.), *Drobci antičnega stekla / Fragment of ancient glass*, 107–114, Koper.

SAGADIN, M. 2008, *Od Karnija do Kranja. Arheološki podatki o razvoju poselitve v antičnem in zgodnjerednjeveškem obdobju*. – Neobjavljena doktorska disertacija / Unpublished doctoral thesis, Oddelek za arheologijo, Filozofska fakulteta Univerze v Ljubljani, Ljubljana.

SAGUI, L. 1993, Produzione vetraria a Roma tra tardo-antico e alto medioevo. – V / In: L. Paroli, P. Delogu (ur. / eds.), *La storia economica do Roma nell'alto medioevo alla luce dei recenti scavi archeologici*, 113–136, Firenze.

SAGUI, L. in / and P. MIRTI 2003, Produzioni di vetro a Roma nell'alto medioevo: dati archeologici e archeometrici. – V / In: D. Foy (ur. / ed.), *Échanges*

*et commerce du verre dans le monde antique*, 87–92, Montagnac.

SALDERN, A. von 1962, Glass from Sardis. – *American Journal of Archaeology* 66/1, 5–12.

SEDLAČKOVÁ, H. 2006, Ninth- to Mid-16th Century Glass finds in Moravia. – *Journal of Glass Studies* 48, 191–244.

SNOJ, D. in / and M. NOVŠAK, 1992, Piran. – *Varstvo spomenikov* 34, 268–272.

STAMENKOVIĆ, S. 2009, Kasnoantičko staklo sa Gradine u Vrsenicama. – V / In: M. Popović, V. Bikić, *Vrsenice. Kasnoantičko i ranosrednjovekovno utvrđenje / Vrsenice. Late Roman and Serbian Early Medieval fortress*, 189–195, Beograd.

STARE, V. 1980, *Kranj. Nekropola iz časa preseljevanja ljudstev*. – Katalogi in monografije 18.

STEINKLAUBER, U. 1990, Der Duel und seine Kleinfunde. – *Carinthia I* 180, 109–136.

STERN, E. M. 1999, Roman Glassblowing in a Cultural Context. – *American Journal of Archaeology* 103/3, 441–484.

STERNINI, M. 1989, A Glass workshop in Rome (4th–5th century AD). – *Köllner Jahrbuch für Vor- und Frühgeschichte* 22, 105–114.

STERNINI, M. 1995, Il vetro in Italia tra V e IX secoli. – V / In: D. Foy (ur. / ed.), *La verre de l'Antiquité tardive et du Haut Moyen Age. Typologie-Chronologie-Diffusion*, 243–289, Guiry en Vexin.

STERNINI, M. 1999, I vetri provenienti dagli scavi della missione Italiana a Cartagine (1973–1977). – *Journal of Glass Studies* 41, 83–103.

STERNINI, M. 2001, Reperti in vetro da un deposito tardoantico sul colle Palatino. – *Journal of Glass Studies* 43, 21–75.

SVOLJŠAK, D. 1985, Sv. Pavel nad Vrtovinom. Rezultati sondiranja leta 1966 (Sv. Pavel über Vrtovin). – *Arheološki vestnik* 36, 195–236.

ŠMIT, Ž., D. JEZERŠEK in / and T. KNIFIC 2010, Raziskave zgodnjerednjeveškega stekla z ozemlja Slovenije. – *Argo* 53/1, 87–89.

ŠMIT, Ž., D. JEZERŠEK, T. KNIFIC in / and J. ISTENIČ 2009, PIXE-PIGE analysis of Carolingian period glass from Slovenia. – *Nuclear Instruments and Methods in Physics Research B* 267, 121–124.

ŠPEHAR, P. 2010, *Materijalna kultura iz ranovizantijskih utvrđenja u Đerdapu*. – *Cahiers des Portes de Fer. Monographies* 7.

TAL, O., R. E. JACKSON-TAL in / and I. C. FREESTONE 2004, New Evidence of the Production of Raw Glass at Late Byzantine Apollonia–Arsuf, Israel. – *Journal of Glass Studies* 46, 51–66.

TALBOT, A. 2005, Evidence about Byzantine Glass in Medieval Greek texts from the Eighth to the Fifteenth Century. – *Dumbarton Oaks Papers* 59, 141–145.

TUŠEK, I. 1997, Skupina poznorimskih grobov z območja izkopa za stanovanjski blok B-2 v Rabelčji vasi – zahod na Ptuju. – *Arheološki vestnik* 48, 289–300.

UBOLDI, M. 1991, Vetri. – V / In: G. P. Brogiolo, L. Castelletti (ur. / eds.), *Archeologia a Monte Barro I. Il grande edificio e le torri*, 85–93, Lecco.

UBOLDI, M. 1995, Lampade vitree in età tardoantica e altomedievale. – *Archeologia medievale* XXII, 93–145.

UBOLDI, M. 1998, Vetri di età tardoantica e altomedievali dagli scavi del monastero di S. Giulia a Brescia. – V / In: *Il vetro dall'antichità all'età contemporanea: aspetti tecnologici, funzionali e commerciali*, 181–187, Milano.

UBOLDI, M. in / and M. VERITÀ 2003, Scientific Analysis of Glasses from Late Antique and Early Medieval Archaeological Sites in Italy. – *Journal of Glass Studies* 45, 115–137.

ULBERT, T. 1981, *Ad Pirum (Hrušica). Spätromische Passbefestigung in den julischen Alpen*. – *Münchener Beiträge zur Vor- und Frühgeschichte* 31.

URLEB, M. 1974, Križna gora pri Ložu. – *Varstvo spomenikov* 17–19/1, 217–230.

VALIČ, A. 1985, Ajdna nad Potoki. – *Varstvo spomenikov* 27, 265–272.

VALIČ, A. 1990, Poznoantično najdišče Sv. Jakob nad Potočami pri Preddvoru (Das spätantike Fundort Sv. Jakob über Potoče bei Preddvor). – *Arheološki vestnik* 41, 431–438.

VOGELPOHL, C. 1975, Der Katalog der Kleinfunde auf dem Hügel von Vranje / Katalog drobnih najdb s cerkvenega kompleksa. – V / In: P. Petru, T. Ulbert, *Vranje pri Sevnici. Starokrščanske cerkve na Ajdovskem gradcu/Vranje bei Sevnica. Frühchristliche Kirchenanlagen auf dem Ajdovski gradec*, Katalogi in monografije 12, 79–93.

WHITEHOUSE, D. 1999, The Date of the Glass from Karanis. – *Journal of glass studies* 41, 168–170.

ZUCCHIATI, A., L. CANONICA, P. PRATI, A. CAGNANA, S. ROASCIO in / and A. CLIMENT-FONT 2007, PIXE analysis of V–XVI century glasses from the archaeological site of San Martino di Ovaro (Italy). – *Journal of Cultural Heritage* 8, 307–314.

ŽONTAR, J. 1982, *Zgodovina mesta Kranja*. – Kranj.





## 4. KERAMIKA

### 4. POTTERY

Zvezdana MODRIJAN

Keramični izdelki, to je izdelki iz oblikovane, žgane glinice, že dolgo časa veljajo za enega najpomembnejših virov arheoloških informacij (Peacock 1977, 21). Zaradi potenciala, ki ga ima keramika tako za datacijo kot za analizo gospodarskih odnosov in socialnih razmerij, ima študij keramike dolgo tradicijo, znotraj katere je mogoče slediti intenzivnemu razvoju. V zadnjem obdobju ga označuje predvsem raznolikost pristopov, ki vključujejo tudi študij tehnologije, etno-arheološke študije, statistične analize in mnoge druge (Orton, Tyers, Vince 1993, 13–22).

Keramično posodje prevladuje tudi med najdbami na Tonovcovem gradu. Skupno je bilo najdenih okrog 150 kg keramičnega posodja. Kot je vidno na *sl. 4.1*, je bila večina (87,7 %) najdenega v izkopnem polju stavbe 1, na območju vseh ostalih raziskanih stavb pa le 12,3 %.<sup>1</sup> Analize, narejene na podlagi teže vsega gradiva, spadajo sicer med najpreprostejše kvantifikacijske metode, uporabne pa so (kot v tem primeru) predvsem za primerjanje istih tipov v različnih skupkih (Orton, Tyers, Vince 1993, 169).<sup>2</sup>

Podoben rezultat razporeditve keramike po objektih je dala tudi analiza, narejena na podlagi štetja značilnih kosov (*sl. 4.2*). Štetje izraža razmerje določenih tipov v skupku, pa tudi stopnjo lomljivosti (Orton, Tyers, Vince 1993, 168–171).<sup>3</sup>

Za nadaljnjo obdelavo (tipološko, tehnološko, statistično) so bili nato izbrani vsi značilni (diagnostični) kosi (odlomki ustij, ročajev, dnov, ornamentiranih ostenj in ostenj z značilnimi fakturami),<sup>4</sup> ki so bili kataloško obdelani (2.340 kosov).

<sup>1</sup> Velik del keramičnih najdb iz cerkva in cisterne izvira iz plasti zgodnesrednjeveške faze, nekaj pa tudi iz prve poznoantične faze.

<sup>2</sup> Znotraj skupka je metoda vprašljiva, saj ne izraža stopnje lomljivosti posod, zato so težki tipi lahko precejšeni.

<sup>3</sup> Ker se nekateri tipi razbijajo na več delov kot ostali (imajo večjo lomljivost), dobimo na ta način popačeno razmerje, saj so številčno bolj zastopani lonci, ki se bolj razbijajo. Kljub temu je metoda za odnose znotraj skupkov primernejša od analize teže (glej op. 2).

<sup>4</sup> Tako imenovana metoda R/B/H (*rim/base/handle*) je časovno veliko manj potratna od metode R/B/H/S (*rim/base/handle/sherd*), ki vključuje tudi obravnavo neokrašenih

Pottery products, i.e. products from fired clay, have been considered one of the most important sources of archaeological information for a very long time (Peacock 1977, 21). Due to the potential it has in determining the date and the insight it offers into the economic and social relations, the study of pottery has a long and intensely developing tradition. Lately, this has been primarily marked by diverse approaches that include the study of technologies, ethno-archaeological studies, statistical analysis and many others (Orton, Tyers, Vince 1993, 13–22).

Pottery is the most common find at Tonovcov grad. In total approximately 150 kg of pottery vessels was discovered. As shown in *Fig. 4.1*, most of it (87.7 %) was found in the excavation area of building 1, while only 12.3 % was discovered in the excavation areas of all other buildings.<sup>1</sup> The analysis conducted on the basis of the weight of all discovered materials are one of the simplest quantification methods and are mainly used (as in this case) for comparing the same types in various assemblages (Orton, Tyers, Vince 1993, 169).<sup>2</sup>

A similar result showing how the pottery was spread throughout the buildings was provided by the analysis conducted on the basis of sherd count (*Fig. 4.2*). This method reflected the proportions of certain pottery types within the assemblage as well as their brokenness (Orton, Tyers, Vince 1993, 168–171).<sup>3</sup>

In the further treatment (typological, technological, statistic) we selected all characteristic (diagnostic) pieces, i.e. fragments of rims, handles, bases, deco-

<sup>1</sup> A large share of the pottery finds from the ecclesiastical complex and the water cistern originates from the Early Medieval layer, while some finds can be dated to Late Antiquity 1 phase.

<sup>2</sup> This method is questionable within a single assemblage, for it does not deal with the brokenness of the pottery, thus the heavier types can be overrated.

<sup>3</sup> As some pottery types break into a larger number of pieces than other (their brokenness is higher), we get a skewed ratio, for the vessels that break into more pieces are better represented as regards their quantities. However, this method is still more useful than weight analysis when comparing the ratios within an assemblage (see note 2).

- stavba 1 / building 1
- stavbi 2 in 3 / buildings 2 and 3
- sklop cerkva / ecclesiastical complex
- cisterna / cistern

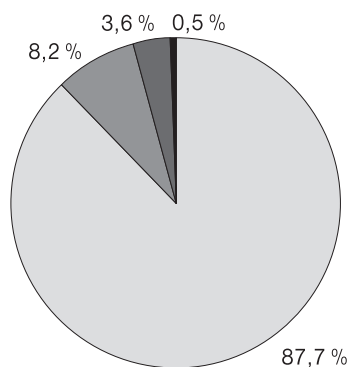

Sl. 4.1: Zastopanost keramičnih posod v raziskanih objektih glede na težo vseh najdenih odlomkov.

Fig. 4.1: Representation of pottery fragments in individual researched buildings according to the weight of all fragments.

Od te količine je bilo za objavo izbranih 2.000 kosov, večinoma tistih, ki jih je bilo mogoče tipološko opredeliti. Izložena so bila neokrašena dna in nekatera okrašena ostenja.

Razmerje med grobo in uvoženo keramiko na Tonovcovem gradu kaže za poznoantične višinske naselbine dokaj tipično sliko. Veliko večino gradiva (87 %) predstavlja groba kuhinjska keramika, izdelana na najdišču ali v njegovi neposredni okolici.<sup>5</sup> Vse ostale zvrsti skupaj dosegajo 13 % po številu značilnih kosov (sl. 4.3).

Groba hišna keramika je najprej razdeljena na dve osnovni obliki (odprto in zaprto), v okviru teh pa na skupine po uporabnosti (lonci, vrči, sklode, krožniki, pokrovi ...).

V skupino uvožene keramike je bilo uvrščeno vse posodje, ki ni bilo narejeno na najdišču ali v njegovi neposredni okolici. To so izdelki, ki so prišli na Tonovcov grad kot posledica prekomorske trgovine z afriškim in vzhodnosredozemskim prostorom (npr. amfore, afriška sigilata), pa tudi tisti, za katere lahko domnevamo, da so širšega regionalnega (npr. severnoitalskega ali panonskega) izvora. Sem sodijo glazirana keramika, imitacije sigilatnih posod in oljenke ter navadna namizna keramika.

Glede na uporabne skupine so med uvoženimi kosi zastopane fina namizna keramika (afriška sigilata, fokejska sigilata), kuhinjska in namizna keramika (afriška kuhinjska keramika, navadna namizna keramika, glazirana keramika), oljenke in amfore.

ostenij, je pa za kvantitativne analize gradiva ravno tako primerna (Tomber 1991; Warner Slane 2003).

<sup>5</sup> Pri tem je treba poudariti, da na Tonovcovem gradu do sedaj ni bilo odkritih nobenih sledi lončarske proizvodnje.

- stavba 1 / building 1
- stavbi 2 in 3 / buildings 2 and 3
- sklop cerkva / ecclesiastical complex
- cisterna / cistern

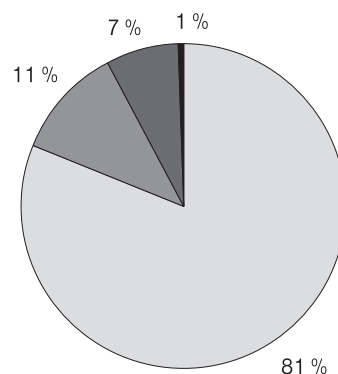

Sl. 4.2: Zastopanost keramičnih posod v raziskanih objektih glede na število značilnih kosov.

Fig. 4.2: Representation of pottery fragments in individual researched buildings according to the number of diagnostic sherds.

rated walls and walls with characteristic fabric (2,340 sherds)<sup>4</sup>.

From this number 2,000 pieces were selected for publication, mostly those that could be typologically defined. The undecorated bases and some decorated walls were eliminated.

On Tonovcov grad the proportion between coarse ware and imported pottery indicates a relatively typical image for hilltop settlements in Late Antiquity. A vast majority of the material (87 %) is represented by coarse kitchenware, manufactured on site or in its close vicinity.<sup>5</sup> If we take into account the number of diagnostic sherds all other types represent 13 % (Fig. 4.3).

First of all the coarse ware was divided into two basic shapes (open and closed), and within these two groups the sherds were divided as regards their use (pots, jugs, bowls, plates, lids ...).

The group of imported pottery included all vessels that were not made on site or in its vicinity. These are products that came to Tonovcov grad through the overseas trade with Africa and the Eastern Mediterranean (e.g. amphorae, African Red Slip Ware), as well as those products for which we can assume a broader regional (e.g. Northern Italic or Pannonian) origin. This group includes glazed pottery, tableware and imitations of African Red Slip Ware and imitations of oil lamps.

<sup>4</sup> The so called R/B/H (rim/base/handle) method takes much less time than the R/B/H/S (rim/base/handle/sherd) method (which also includes the treatment of undecorated walls), however it is just as suitable for a quantitative analysis of the materials (Tomber 1991; Warner Slane 2003).

<sup>5</sup> At this it should be emphasised that so far no traces of pottery production have been discovered on Tonovcov grad.

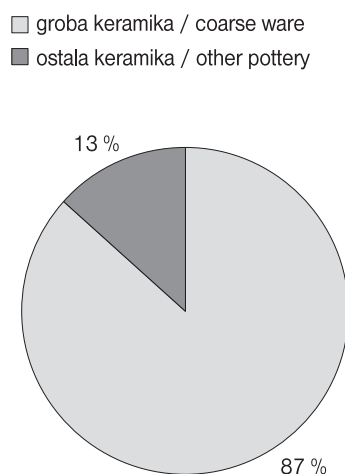

Sl. 4.3: Zastopnost grobe in ostale keramike v raziskanih objektih glede na število značilnih kosov.

Fig. 4.3: Representation of coarse ware and other pottery in all researched buildings according to the number of diagnostic sherds.

Uvožena in groba keramika sta bili obravnavani ločeno. Za uvrstitev in datacijo uvožene keramike so bile uporabljene že uveljavljene tipološko-kronološke sheme, za grobo keramiko pa je bila zaradi njene specifičnosti in lokalne omejenosti izoblikovana samostojna tipološka shema.

Keramika je bila obravnavana po stavbah, znotraj njih pa razvrščena tipološko. V primerih, ko so bili predmeti najdeni v stratigrafsko jasnih kontekstih, so bili ti upoštevani pri obravnavi. S pomočjo dobro kronološko opredeljenih najdb keramike (predvsem uvoženo posodje) so bili ti konteksti tudi datirani (za datacijo posameznih faz glej pogl. 1.1).<sup>6</sup> Tako dobljeni podatki so nato služili tudi kot pomoč pri okvirni dataciji sicer časovno slabo opredeljive grobe keramike.

## 4.1 UVOŽENA KERAMIKA

Med uvoženo keramiko so bile na Tonovcovem gradu prepoznane afriška sigilata in njene imitacije, vzhodna sigilata (Late Roman C – LRC), afriške oljenke in njihove imitacije, afriška kuhinjska keramika, navadna namizna keramika, glazirana keramika in amfore.

Uvožena keramika sicer predstavlja manjši del v celotnem keramičnem inventarju (prim. sl. 4.3), vendar je pomembna za datacijo posameznih faz naselja, dokazuje pa tudi vpetost naselbine v širše trgovske (tudi prekomorske) povezave vse do njenega propada.

<sup>6</sup> Večina drugega časovno dobro opredeljivega gradiva (nakit, novci ...) je bila najdena v nezanesljivo opredeljenih ali premešanih plasteh (glej tudi: Tonovcov grad. Naselbinski ostanki in interpretacija, pogl. 2.1, 2.2).

Taking into account their use, the imported pieces can be divided into fine tableware (African Red Slip Ware, Phocaean Red Slip Ware), kitchenware and tableware (African kitchenware, common tableware, glazed pottery), oil lamps and amphorae.

The imported pottery and coarse pottery were treated separately. We used the established typological and chronological schemes for typological and chronological placing of the imported pottery, while due to the specifics and local limitations we established an independent typological scheme for the coarse ware.

The pottery was lined up typologically within individual buildings. When the objects were found in stratigraphically clear contexts, these were taken into account in the analysis. With the aid of chronologically clearly defined pottery finds (especially imported pottery) these contexts could be dated (for the chronological placing of the phases see chapter 1.1).<sup>6</sup> Data obtained in this way served to provide the time definition of the otherwise hard to date coarse ware.

## 4.1 IMPORTED POTTERY

At Tonovcov grad imported pottery consisted of African Red Slip Ware and its imitations, Eastern sigillata (Late Roman C – LRC), African oil lamps and their imitations, African kitchenware, common tableware, glazed pottery and amphorae.

Imported pottery represents a small share of the entire pottery inventory (cf. Fig. 4.3), however it is important for the dating of the individual settlement phases, and it also proves the inclusion of the settlement into the broader trade (including overseas) connections until its decline.

Most of the imported pieces were found in the excavation area of building 1 (Pls. 64-73), only individual pieces appeared in the area of buildings 2 and 3 and the ecclesiastical complex (Pls. 100-101). This also suits the otherwise modest number of all finds outside of the excavation area of building 1.

### 4.1.1 AFRICAN RED SLIP WARE AND ITS IMITATIONS

African Red Slip Ware (ARSW) is a group of fine tableware, made from orange-red to brick-red fired clay with fine (sometimes invisible to the naked eye) limestone, quartz and mica particles, with a slip of the same or similar colour as fired clay. The slip can cover all or merely a part of the surface.

Such pottery originates from North African workshops that had a centre in Tunisia, and was produced be-

<sup>6</sup> Most of the other reliably dated material (jewellery, coins, etc.) was found in mixed layers (see also: Tonovcov grad. Settlement remains and interpretation, chapters 2.1, 2.2).

Večina uvoženih kosov je bila najdena na območju izkopnega polja stavbe 1 (*t.* 64–73), le posamično pa se uvoženo gradivo pojavlja na območju stavb 2 in 3 in cerkvenega sklopa (*t.* 100–101). To ustreza tudi sicer skromnemu številu vseh najdb zunaj izkopnega polja stavbe 1.

#### 4.1.1 AFRIŠKA SIGILATA IN NJENE IMITACIJE

Afriška sigilata je ime za skupino fine namizne keramike, izdelane iz prečiščene, oranžnordeče do opečno rdeče žgane glinice z drobnimi (včasih s prostim očesom nevidnimi) primesmi apnenca, kremena in sljude, s premazom v isti ali zelo podobni barvi, kot je žgana glina. Premaz lahko pokriva vso površino posode ali le njen del.

Tovrstno posodje izvira iz severnoafriških delavnic s središčem v Tuniziji, obsega pa širok časoven razpon od 1. do 7. st. Do začetka 3. st. je bilo v glavnem omejeno na severnoafriške in sosednje province, občasno je prihajalo tudi v večja središča imperija. Na širše sredozemsko območje je v večjem obsegu začelo prihajati od začetka 4. st. dalje, z začetkom množične proizvodnje D na območju severne Tunizije (Carandini 1981, 15; Carandini, Tortorella 1981, 78–116). Večinoma je predstavljalo dodatek osnovnemu ladijskemu tovoru, kot so amfore z oljem, vinom in žitom, pa tudi drugi, predvsem luksuzni afriški produkti (les, marmor, slonovina).<sup>7</sup>

Prve študije te keramike so prinesle različna poimenovanja (Late Roman A, B: Waagé 1948; terra sigillata chiara: Lamboglia 1958, 1963). Leta 1972 je izšel Hayesov temeljni priročnik *Late Roman Pottery*, ki temelji v glavnem na tipološki razdelitvi in za tovrstno keramiko uvaja izraz *African Red Slip Ware* (Hayes 1972). V angleški literaturi je termin splošno sprejet, uporablja se tudi okrajšava ARSW. V Italiji so uvedli izraz *sigillata africana* ob objavi bogatega gradiva iz Ostije (Ostia 1–4, 1968, 1970, 1973, 1977). Izraz je bil dokončno sprejet z velikim delom *Atlante delle forme ceramiche*, v katerem so keramične oblike razdeljene po proizvodnjah A1–2, A/C, C1–5, A/D, D1–2, C/E in E (Atlante I, 1981).<sup>8</sup> Zadnje tipološko razdelitev afriške sigilate je predlagal Michel Bonifay (2004), ki jo je, ob upoštevanju keramičnih skupin od A do E, razdelil na 60 tipov in jih uskladi-

<sup>7</sup> Vzhodno Sredozemlje z uvozom afriške sigilate, ne pa afriških amfor, kaže, da obstajajo tudi izjeme in da se je z afriško sigilato lahko trgovalo tudi brez povezave z amforami (Bonifay 2004, 463).

<sup>8</sup> Delitev ne temelji na popolnoma jasnih kriterijih, poleg tega ni podprta z mineraloški in kemijski analizami (Mackensen 1993, 166–167; Pröttel 1996, 13–14; Ladstätter 2000, 86–87). Problemi se pojavljajo predvsem pri zelo heterogenih produkcijah, kot je npr. produkcija D. Tudi zadnje raziskave v Afriki kažejo na veliko kompleksnost lokalnih faktor in zato neprimernost uporabe klasičnih klasifikacij (Bonifay 2004, 48–49).

tween the 1<sup>st</sup> and 7<sup>th</sup> centuries. Until the beginning of the 3<sup>rd</sup> century it was mainly limited to North Africa and the neighbouring provinces, and it only occasionally reached the larger centres across the empire. It began reaching the broader Mediterranean area in larger numbers at the beginning of the 4<sup>th</sup> century when its mass production started in Northern Tunisia (Carandini 1981, 15; Carandini, Tortorella 1981, 78–116). In most cases it represented an addition to the primary ship cargo, such as amphorae with oil, wine and wheat, as well as other, predominantly luxurious African products (wood, marble, ivory).<sup>7</sup>

The first studies of this pottery resulted in various names (Late Roman A, B: Waagé 1948; terra sigillata chiara: Lamboglia 1958, 1963). In 1972 John Hayes published his manual *Late Roman Pottery*, which is predominantly based on the typological division and that introduces the term *African Red Slip Ware* (Hayes 1972). This term has been generally adopted in English literature, and the abbreviation ARSW is also used. In Italy the term *sigillata africana* was introduced in the publication describing the rich finds from Ostia (Ostia 1–4, 1968, 1970, 1973, 1977). The term was finally adopted in the extensive work *Atlante delle forme ceramiche*, in which pottery forms are divided according to their production into A1–2, A/C, C1–5, A/D, D1–2, C/E and E (Atlante I, 1981).<sup>8</sup> The last typological division of African Red Slip Ware was proposed by Michel Bonifay (2004), who divided ARSW into 60 types that he harmonised with the older typologies (Bonifay 2004, 155–210, typological index 519–520).

In 1992 Slovenian archaeological literature started using the term African sigillata, as proposed by Verena Vidrih Perko (1992a, 93–95, note 1; Cunja 1996; Ciglencečki 2000) who decided to follow the Italian terminology.<sup>9</sup>

The preliminary research on African Red Slip Ware was focused on the research of the consumption centres (Athens, Ostia, Albintimilium), and it was only later on that the research extended also on the production

<sup>7</sup> With its imports of African Red Slip Ware (and not African amphorae) the Eastern Mediterranean area indicates that there are also exceptions and that one could trade with ARSW even without the amphorae connection (Bonifay 2004, 463).

<sup>8</sup> This division is not based on clear criteria, neither is it supported by mineralogical and chemical analysis (Mackensen 1993, 166–167; Pröttel 1996, 13–14; Ladstätter 2000, 86–87). The main problems arise with heterogeneous productions, such as for example production D. The latest research in Africa shows great complexity of local workshops and this is why the use of classical interpretations is not suitable (Bonifay 2004, 48–49).

<sup>9</sup> In Slovene archaeological literature such pottery was often not recognised in the past, and even when it was it appeared under a lot of names, e.g. sigillata chiara, Mediterranean pottery, red slip ware with African fabric (Korošec 1956; P. and J. Korošec 1978; Mikl-Curk 1983).

tudi s starejšimi tipologijami (Bonifay 2004, 155–210, tipološki indeks 519–520).

V slovenski arheološki literaturi se po letu 1992 uporablja izraz afriška sigilata, ki ga je po italijanskem zgledu predlagala Verena Vidrih Perko (1992a, 93–95, op. 1; Cunja 1996; Ciglencečki 2000).<sup>9</sup>

V prvem obdobju raziskav je bil študij afriške sigilate usmerjen predvsem v raziskavo potrošnih centrov (Atene, Ostia, Albintimilium), kasneje so se raziskave usmerile tudi na njena izvorna področja v severni Afriki (Fulford, Peacock 1984; 1994; Mackensen 1993; zbrano pri Bonifay 2004, 45, op. 62).

Nadaljujejo se tudi raziskave v potrošnih centrih na obalah Sredozemlja. Poleg že omenjenih študij na območju Italije je treba omeniti še raziskave v Španiji (Reynolds 1993; 1995) in v Franciji (Bonifay, Piéri 1995; Bonifay 1998; Pieri 2005).

V jugovzhodnoalpskem prostoru je afriška sigilata 4. in 5. st. dokaj pogosta v mestih, medtem ko je na poznoantičnih višinskih naselbinah v tem času med redkejšimi najdbami. Predvsem od začetka devetdesetih let dvajsetega stoletja dalje je pogosto predmet študij. Pregled vseh do tedaj znanih najdb iz Slovenije in severnojadranskega področja je pripravil Philipp Pröttel (1996). Z afriško sigilato s slovenskega prostora se je v več člankih ukvarjala Verena Vidrih Perko (Vidrih Perko 1992a; 1992b; 1994a; 1997a; 1997b; Perko, Plesničar Gec 1991; Vidrih Perko, Žbona Trkman 2004). Radovan Cunja je ob objavi materiala s Kapucinskega vrta v Koprju objavil tudi bogato sigilatno gradivo (Cunja 1996). Afriško sigilato z Invillina je obdelal Michael Mackensen (1987), z dela višinske naselbine na Sv. Hemi na Koroškem pa Sabine Ladstätter (2000). Študija je dopolnjena tudi z arheometričnimi analizami (Ladstätter, Sauer 2000, 85–90). Najdbe s področja Furlanije je zbral Luca Villa (1998, 275–288). V zadnjem obdobju so bile obdelane najdbe iz Školaric pri Spodnjih Škofijah (Žerjal 2008) in Kranja (Sagadin 2008).

Afriška sigilata na Tonovcovem gradu je dokaj redka in tudi nabor tipov je skromen. V izkopnem polju stavbe 1 je bilo mogoče rekonstruirati 13 posod (*t. 64; 65: 1–2*), najdenih pa je bilo še nekaj odlomkov ostenj, ki jih ni bilo moč pripisati nobenemu tipu, pripadajo pa severnotunizijski proizvodnji D. Na območju stavbe 2 so bili najdeni le ploščica, izdelana iz sigilatne posode (*t. 100: 2*), ter nekaj neopredeljivih odlomkov ostenj. Z območja cerkvenega sklopa je znan le en primer afriške sigilate, odlomek dna, ki je bil najden v severni cerkvi (*t. 101: 3*).

<sup>9</sup> V slovenski arheološki literaturi v preteklosti tovrstna keramika večkrat ni bila prepoznana, sicer pa je bilo v uporabi več poimenovanj, npr. sigillata chiara, mediteranska keramika, sigilata z afriško fakturo (Korošec 1956; P. in J. Korošec 1978; Mikl-Curk 1983).

centres in North Africa (Fulford, Peacock 1984; 1994; Mackensen 1993; collected at Bonifay 2004, 45, note 62).

The research in consumption centres on the Mediterranean coast is continued. Apart from the previously mentioned studies we also have to mention the research carried out in Spain (Reynolds 1993; 1995) and France (Bonifay, Piéri 1995; Bonifay (ed.) 1998; Pieri 2005).

In the Southeastern Alpine towns African Red Slip Ware was relatively common during the 4<sup>th</sup> and 5<sup>th</sup> century, however it remained a rare find in Late Antique hilltop settlements. In the beginning of the 1990s it became a popular subject in numerous studies. In 1996 Philipp Pröttel prepared an overview of all known finds in Slovenia and the Northern Adriatic (Pröttel 1996). Verena Vidrih Perko studied African Red Slip Ware in Slovenia in a number of her articles (Vidrih Perko 1992a; 1992b; 1994a; 1994b; 1997a; 1997b; Perko, Plesničar Gec 1991; Vidrih Perko, Žbona Trkman 2004). In his publication of the material from Kapucinski vrt in Koper Radovan Cunja also published the rich finds of African Red Slip Ware material (Cunja 1996). ARSW from Invillino was studied by Michael Mackensen (1987), while the one from the hilltop settlement of Hemmaberg in Carinthia was studied by Sabine Ladstätter (2000). Archaeometry analysis was also used in the study (Ladstätter, Sauer 2000, 85–90). The finds from Friuli were collected by Luca Villa (1998, 275–288). Recently also the finds from Školarice near Spodnje Škofije (Žerjal 2008) and Kranj (Sagadin 2008) have been processed.

The African Red Slip Ware appears on Tonovcov grad relatively rarely and in a modest variety of types. It was possible to reconstruct 13 vessels from the excavation area of building 1 (*Pls. 64; 65: 1–2*). A few wall fragments were also discovered, however they could not be attributed to any specific type, even though it is clear that they belong to the north Tunisian production D. In the excavation area of building 2 only one lamella made from a bottom of an ARSW vessel was discovered (*Pl. 100: 2*) and a few indefinable fragments of walls. A single piece of ARSW was discovered in the ecclesiastical complex, i.e. a base fragment that was found in the north church (*Pl. 101: 3*).

#### HAYES 58

Three bowls (*Pl. 64: 1–3*) can be determined as form Hayes 58 or (considering its relatively small diameter) its slightly earlier form Hayes 32/58. All three examples were made from purified orange clay and are poorly preserved. Only remains of the matt slip have remained.

Form Hayes 58 or 32/58 often appears in Roman towns in Slovenia. Examples are known from Ptuj (Pröttel 1996, *Pl. 2: 2,4,6–7,16–17*), Celje (Pröttel 1996, *Pl. 3: 17*), Ljubljana (Pröttel 1996, *Pl. 8: 6,8–9*; Vidrih Perko 1992a, *Pl. 2: 4*, cat. Nos. 35–38) and Koper (Cunja 1996,

## HAYES 58

Tri skleda (*t. 64: 1–3*) lahko pripišemo obliki Hayes 58 oziroma (glede na dokaj majhen premer) nekoliko zgodnejši Hayes 32/58. Vsi trije primerki so slabo ohranjeni, izdelani iz prečiščene glin svetlooranžne barve. Ohranjeni so le ostanki nebleščече premaza.

Oblika Hayes 58 oziroma 32/58 se pogosto pojavlja v rimskih mestih v Sloveniji. Znana je npr. s Ptuja (Pröttel 1996, t. 2: 2,4,6–7,16–17), iz Celja (Pröttel 1996, t. 3: 17) in Ljubljane (Pröttel 1996, t. 8: 6,8–9; Vidrih Perko 1992a, t. 2: 4, kat. št. 35–38). Primerek s Kapucinskega vrta v Kopru ima pod ustjem na zunanji strani okras vrbovih listov (Cunja 1996, t. 8: 119). Oblika je dokaj pogosto zastopana tudi na Hrušici (Pröttel 1996, t. 14: 2–22). Pogojno lahko tej obliki pripišemo primerek iz Kranja (Sagadin 2008, 100, t. 9: 17).

Oblika Hayes 32/58 je datirana v pozno 3. in zgodnje 4. st., oblika 58 vse do zadnje tretjine 4. st. (Hayes 1972, 96; Atlante I, 81–82; Cunja 1996, 95–96).

Na Tonovcovem gradu so bili vsi trije primerki najdeni na območju stavbe 1. Eden izvira iz plasti prve poznoantične faze (*t. 64: 2*), drugi iz druge poznoantične faze (*t. 64: 1*), zadnji pa celo iz zgodnesrednjeveške plasti (*t. 64: 3*). Verjetno lahko vse obravnavane primerke datiramo v 4. st., primerka iz mlajših plasti sta tako residualna kosa.

## HAYES 61 B IN IMITACIJE

Trije globoki krožniki s širokim, navpično oblikovanim robom (*t. 64: 4–6*) pripadajo obliki Hayes 61 B. Vsi trije so izdelani iz temno oranžne, trdo žgane glin z majhnimi apnenčastimi vključki in komaj opaznimi sledovi sljude. Premaz je nebleščječ.

Morda obliki 61 B ali pa njeni imitaciji pripada tudi zelo slabo ohranjeno ustje na *t. 64: 7*. Njegova faktura je namreč mehka, kredasta, premaz ni ohranjen, zabrisani so tudi robovi posode.

Krožniki Hayes 61 s svojimi variantami spadajo med najbolj razširjene oblike afriške sigilate v Sredozemlju. Oblika je doživela precejšen tipološki razvoj, ki je skupaj z datacijo še vedno predmet diskusije (zbrano pri Bonifay 2004, 167–171).<sup>10</sup>

Oblika je Hayes datiral v čas prve polovice 5. st. (Hayes 1972, 107). Kasneje je datacijo začetka izdelave postavil v čas okrog leta 380, predvsem na podlagi najdb teh posod na Hrušici (Hayes 1980, 516). V zadnjo tretjino 4. st. postavlja začetek njihove izdelave tudi Pröttel (1996, 57). Dokaj pozna je datacija Reynoldsa,

<sup>10</sup> Zadnji predlog uvaja novo skupino 61 C oziroma tip 39 (Bonifay 2004, 170–171) za pozne oblike krožnikov z masivnim, poševno nagnjenim ustjem trikotnega preseka in kaneluro na notranjem robu ustja, značilnih za sredino in drugo polovico 5. st. (Bonifay 2004, 167–171).

Pl. 8: 119; with the decoration in the form of willow leaves on the outer side, under the rim). These bowls are relatively common also at Hrušica (Pröttel 1996, Pl. 14: 2–22). The example from Kranj can also be conditionally included into this type (Sagadin 2008, 100, Pl. 9: 17).

Form Hayes 32/58 is dated into the late 3<sup>rd</sup> and early 4<sup>th</sup> century, whilst form 58 continues right until the last third of the 4<sup>th</sup> century (Hayes 1972, 96; Atlante I, 81–82; Cunja 1996, 95–96).

At Tonovcov grad all three examples were found in the area of building 1. One was discovered in the layer of Late Antiquity phase 1 (*Pl. 64: 2*), one in the layer of Late Antiquity phase 2 (*Pl. 64: 1*), and the last in an Early Medieval layer (*Pl. 64: 3*). It can be assumed that all of the treated vessels were manufactured in the 4<sup>th</sup> century and that the examples in the younger layers represent residual pieces.

## HAYES 61 B AND ITS IMITATIONS

Three deep plates with a wide, vertically designed rim (*Pl. 64: 4–6*) belong to form Hayes 61 B. All three were manufactured from dark orange, hard fired clay with small limestone inclusions and hardly noticeable traces of mica. The slip was matt.

It is possible that the extremely poorly preserved rim on *Pl. 64: 7* also belongs to form Hayes 61 B or its imitation. Its fabric is soft, powdery, the slip is not preserved and the edges of the vessel are also unclear.

Plates Hayes 61 and its variants are one of the most commonly spread form of African Red Slip Ware in the Mediterranean. The form has experienced a vast typological development, which is together with its chronological placement still under discussion (collected at Bonifay 2004, 167–171).<sup>10</sup>

Hayes dated this shape into the first half of the 5<sup>th</sup> century (Hayes 1972, 107). Later he set the date of the beginning of its manufacture into approximately 380 AD, mainly on the basis of the appearance of these plates at Hrušica (Hayes 1980, 516). Pröttel also places the beginning of its production into the last third of the 4<sup>th</sup> century (Pröttel 1996, 57). Due to the absence of this type in the 4<sup>th</sup> and early 5<sup>th</sup> century contexts in Carthago Reynolds dates its beginning as late as 420 AD (Reynolds 1995, 148).<sup>11</sup> Bonifay proposed a new typology and

<sup>10</sup> The last proposal introduces a new group 61 C or type 39 (Bonifay 2004, 170–171) for the later plate shapes with the massive, askew rims with a triangular cross-section and a groove on the inner rim edge, which are characteristic for the mid and second half of the 5<sup>th</sup> century (Bonifay 2004, 167–171).

<sup>11</sup> This absence is more than chronologically explainable by the origin of the vessels, for the workshops in the hinterland of Carthago, from which most of the vessels found in these contexts originate, did not produce form Hayes 61 B (Pröttel 1996, 56–57, note 5).

ki na podlagi odsotnosti tega tipa v kontekstih poznega 4. in zgodnjega 5. st. v Kartagini predpostavlja njegov začetek šele ok. l. 420 (Reynolds 1995, 148).<sup>11</sup> Nov predlog tipologije in kronologije je ponudil Bonifay (2004, 167–171). Tako imenovano klasično obliko Hayes 61 B (varianti B1 in B2) postavlja v prvo polovico 5. st., vendar poudarja, da se na najdiščih severozahodnega Sredozemlja ne pojavljajo pred koncem prve četrtine 5. st. (Bonifay 2004, 171). To stanje se razlikuje od tistega v jugovzhodnoalpskem prostoru, kjer lahko pojavljanje te oblike sledimo vsaj od konca 4. st. dalje, kar kaže predvsem njena precejšnja pogostost na Hrušici. Največjo priljubljenost tudi v jugovzhodnih Alpah pa je oblika Hayes 61 B dosegla v prvi polovici 5. st. Na Vranju je bila najdena v "žganem horizontu", datiranjem v prvo polovico do sredine 5. st. (Pröttel 1996, 56–57). V ta čas sta datirana tudi primerka z Rodika (Vidrih Perko 1997a, 342) in Kučarja (Ciglencečki 1995, 147).

V jugovzhodnoalpskem prostoru je oblika znana s Hrušice (Giesler 1981, t. 34: 9–10; Pröttel 1996, t. 16: 1–13), iz Ajdovščine (Pröttel 1996, t. 22: 7–23; 24: 24–25, 27–28; 25: 1), Emone (Pröttel 1996, t. 7: 18; 8: 15), z Rodika (Vidrih Perko 1997a, 347–348, sl. 1: 12; 2: 48), iz Štanjela (Vidrih Perko 1997b, t. 5: 7), Predloke (Pröttel 1996, t. 28: 14), Tominčeve jame (Pröttel 1996, t. 28: 1), Fizin pri Portorožu (Gaspari et al. 2007, t. 5: 123; 6: 162), s Školaric pri Spodnjih Škofijah (Žerjal 2008, t. 20: 441–445; 21: 446–454), iz Akvileje (Ventura 1991, t. 17: CA 54; Cividini 1994, t. 17: CA 70, CA 71, CA 73), Trsta (Zulini 2007a, 46–47, t. 8: 20), Concordije (Pröttel 1996, t. 40: 10–18), z Invillina (Mackensen 1987, sl. 37: 2–3), s Sv. Heme (Ladstätter 2000, t. 1: 6–10), Kučarja (J. Dular, Ciglencečki, A. Dular 1995, t. 79: 9; 80: 14), z Ajdovskega gradca nad Vranjem (Pröttel 1996, t. 4: 8, 10–12), Ančnikovega gradišča (Strmčnik Gulič 1988, t. 1: 18) in Polhograjske gore (Pröttel 1996, t. 9: 10).

Na Tonovcovem gradu so bili vsi trije zanesljivo prepoznani krožniki oblike Hayes 61 B najdeni na območju stavbe 1, v plasteh prve poznoantične faze (glej Tonovcov grad. Naselbinski ostanki in interpretacija, sl. 3.2: 8; 3.4: 21; 3.8: 11).

Ravno dno krožnika, okrašeno z žigosanimi palmovimi listi med dvema koncentričnima krožnicama (t. 64: 10), je izdelano iz dokaj mehke, svetlo oranžno žgane gline. Ohranjeni so le še sledovi nekoliko temnejšega neblešččega premaza. Zgornji del krožnika ni ohranjen.

Žigosan okras je pogost predvsem na afriški sigilati proizvodnje D. Naš primerek ima liste preproste oblike brez sredinskega rebra. Pripada stilu A III po Hayesu (El Mahrine I.3, Mackensen 1993), za katerega je značilen dokaj velik in preprost okras, ki je pomaknjen proti robu dna, tako da je osrednji del prazen. Stil je datiran v

chronology (Bonifay 2004, 167–171). He placed the so-called classical form Hayes 61 B (variants B1 and B2) into the first half of the 5<sup>th</sup> century, however at this he emphasised that they did not appear in the northwest Mediterranean before the end of the first quarter of the 5<sup>th</sup> century (Bonifay 2004, 171). The situation is different in the Southeastern Alps, where this form appeared at the end of the 4<sup>th</sup> century (if not before), which is mainly shown by the relative common appearance of this type at Hrušica. Similarly, Hayes form 61 B reaches its greatest popularity in the Southeastern Alps during the first half of the 5<sup>th</sup> century. On Ajdovski gradec above Vranje a fragment of this type was found in the 'charred horizon', which has been dated between the first half and the mid 5<sup>th</sup> century (Pröttel 1996, 56–57). The two examples from Rodik (Vidrih Perko 1997a, 342) and Kučar (Ciglencečki 1995, 147) are also dated into this period.

In the Southeastern Alps plates belonging to this form have been found at Hrušica (Giesler 1981, Pl. 34: 9–10; Pröttel 1996, Pl. 16: 1–13), in Ajdovščina (Pröttel 1996, Pls. 22: 7–23; 24: 24–25, 27–28; 25: 1), Emona (Pröttel 1996, Pls. 7: 18; 8: 15), at Rodik (Vidrih Perko 1997a, 347–348, Figs. 1:12; 2: 48), in Štanjel (Vidrih Perko 1997b, Pl. 5: 7), Predloka (Pröttel 1996, Pl. 28: 14), Tominčeva jama (Pröttel 1996, Pl. 28: 1), Fazine near Portorož (Gaspari et al. 2007, Pls. 5: 123; 6: 162), Školarice near Spodnje Škofije (Žerjal 2008, Pls. 20: 441–445; 21: 446–454), Aquileia (Ventura 1991, Pl. 17: CA 54; Cividini 1994, Pl. 17: CA 70, CA 71, CA 73), Trieste (Zulini 2007a, 46–47, Pl. 8: 20), Concordia (Pröttel 1996, Pl. 40: 10–18), at Invillino (Mackensen 1987, Fig. 37: 2–3), Hemmaberg (Ladstätter 2000, Pl. 1: 6–10), Kučar (J. Dular, Ciglencečki, A. Dular 1995, Pls. 79: 9; 80: 14), Vranje (Pröttel 1996, Pl. 4: 8, 10–12), Ančnikovo gradišče (Strmčnik Gulič 1988, Pl. 1: 18) and Polhograjska gora (Pröttel 1996, Pl. 9: 10).

On Tonovcov grad three plates were reliably determined to belong to form Hayes 61 B, all of which were discovered in the area of building 1, in the layers of the first Late Antiquity phase (see Tonovcov grad. Settlement remains and interpretation, Figs. 3.2: 8; 3.4: 21; 3.8: 11).

The straight plate base, decorated with a stamp of palm leaves between two concentric circles (Pl. 64: 10), is made from relatively soft, bright orange fired clay. Only traces of a slightly darker matt slip are preserved. The upper part of the plate is not preserved.

The stamp decoration is common on African Red Slip Ware of D-production. Our example has simple leaves without a central rib. According to Hayes' classification it belongs to style A III (El Mahrine I.3, Mackensen 1993) for which a relatively large and simple decoration moved towards the edge of the base, leaving the centre of the floor plain, is typical. This style is dated into the 5<sup>th</sup> century (Hayes 1972, 219–220), Mackensen places it into phase El Mahrine 1c which lasted until 450 (Mackensen 1993, 433–435). In the Southeastern Alps the stamped palm leaves decoration on the base of the plate is relatively

<sup>11</sup> Ta odsotnost je bolj kot kronološko razložljiva z izvorom posod, saj delavnice v zaledju Kartagine, iz katerih izvira večina v teh kontekstih najdenih posod, niso proizvajale oblike Hayes 61 B (Pröttel 1996, 56–57, op. 5)

5. stoletje (Hayes 1972, 219–220), po Mackensenu v fazo El Mahrine 1c do leta 450 (Mackensen 1993, 433–435). Žigosan okras palmovih listov na dnu krožnika je v jugovzhodnoalpskem prostoru dokaj pogost, večinoma pa pripada stiloma Hayes A II in Hayes A III. Posode z žigosanim okrasom so znane iz Predjame (Korošec 1956, sl. 15: 5), kjer se okras pojavlja na krožniku oblike Hayes 59 B in pripada stilu Hayes A II (Pröttel 1996, 228–229, t. 25: 6a–b; 68: 4), Ljubljane (Vidrih Perko 1992a, t. 2: 12–13,15; Pröttel 1996, t. 9: 5 – stil A II, oblika 61 A), s Hrušice (Giesler 1981, t. 35: 13–14 – stil A II; Pröttel 1996, t. 5: 13 – stil A II) iz Ajdovščine (Pröttel 1996, t. 20: 7–8,10) in Povirja (Pröttel 1996, t. 27: 11). Na Sv. Hemi je bil najden primerek stila Hayes A III (Ladstätter 2000, 98–99, t. 3: 5). V vseh naštetih primerih so palmovi listi postavljeni radialno, s spodnjim delom veje proti središču posode, medtem ko ima primerek s Tonovcovega gradu liste razporejene okrog oboda. Tak primerek je znan iz Concordije, kjer pa so listi tipa Hayes IV/El Mahrine 4:1 s sredinskim rebrom (Pröttel 1996, 260–261, št. 112, t. 78: 16). Primerek krožnika Hayes 61 B z okrasom z obodno postavljenimi listi stila Hayes A III je bil najden na Brionih (Pröttel 1996, 273, št. 32, t. 93: 2).

Okras stila Hayes A III je najpogostejši na krožnikih oblik Hayes 61 B, 64, 67, 69 in 76 (Hayes 1972, 219), katerih okvirna datacija je 5. st. Glede na pogostost oblike 61 B na Tonovcovem gradu lahko domnevamo, da gre prav zanjo. Obravnavani krožnik je bil najden na območju stavbe 1 v plasti druge poznoantične faze.

Skleda (t. 64: 8) po obliki posnema skledo oblike Hayes 61 B, vendar se od njih razlikuje po fakturi. Izdelana je iz oranžno žgane, porozne gline, z drobnimi primesmi apnenca in sljude, brez premaza. Površina je na otip kredasta. Gre za imitacijo posode tipa Hayes 61 B, ki je tako v italiskem kot vzhodnoalpskem prostoru zelo pogosto posnemana oblika.<sup>12</sup> V Sloveniji so primerki imitacije te oblike znani iz Emone (Perko, Plesničar Gec 1992, 111, t. 4: 9) in Ajdovščine (Vidrih Perko, Žbona Trkman 2004, 282), na Hrušici so znane imitacije drugih tipov (Giesler 1981, t. 36: 7–10,20–21,39). Najdene so bile tudi v Predjami.<sup>13</sup>

Delavnice skled, ki posnemajo obliko Hayes 61, so bile v Italiji najdene predvsem v ruralnih okoljih osrednje in južne Italije (Fontana 1998, 89–97). Severno od Alp domnevajo lokalne delavnice, ki so proizvajale tudi imitacije afriških produktov, na območju Recije (Mackensen 1983, 202; Ladstätter 2000, 98, s tam citirano literaturo).

<sup>12</sup> Kot kriterij za določanje imitacij afriške sigilate je predvsem v starejši literaturi veljala odsotnost premaza na posodah, ki po obliki in fakturi drugače kažejo značilnosti afriške proizvodnje, vendar pa odsotnost premaza ne more biti odločujoča, saj je lahko odvisna tudi od postdepozicijskih procesov (Ladstätter 2000, 98–99).

<sup>13</sup> Neobjavljeno, za informacijo se zahvaljujem V. Vidrih Perko.

common, and is most frequently found on plates that belong to Hayes style A II and A III. Vessels with stamp decorations were discovered in Predjama (Korošec 1956, Fig. 15: 5), where a Hayes A II decoration appeared on a plate form Hayes 59 B (Pröttel 1996, 228–229, Pls. 25: 6a–b; 68: 4), Ljubljana (Vidrih Perko 1992a, Pl. 2: 12–13,15; Pröttel 1996, Pl. 9: 5 – style A II, form 61 A), at Hrušica (Giesler 1981, Pl. 35: 13–14 – style A II; Pröttel 1996, Pl. 5: 13 – style A II), in Ajdovščina (Pröttel 1996, Pl. 20: 7–8,10) and Povir (Pröttel 1996, Pl. 27: 11). At Hemmaberg an example of Hayes A III (Ladstätter 2000, 98–99, Pl. 3: 5) was discovered. In all of the mentioned examples the palm leaves were positioned radially so that the bottom of the leaf was oriented towards the centre of the plate, while in the example on Tonovcov grad the leaves are positioned around the rim. Such is the example from Concordia, however there the leaves are type Hayes IV/El Mahrine 4:1 and they have a central rib (Pröttel 1996, 260–261, No. 112, Pl. 78: 16). A plate Hayes 61 B with a decoration of style Hayes A III in the form of leaves positioned along the rim was found on the islands of Brioni (Pröttel 1996, 273, No. 32, Pl. 93: 2).

Decoration Hayes A III mostly appears on plates Hayes 61 B, 64, 67, 69 and 76 (Hayes 1972, 219), which can roughly be dated into the 5<sup>th</sup> century. Taking into account the frequency of type 61 B on Tonovcov grad we can assume that it belongs to this type. The analysed plate was discovered in the area of building 1, in the layer of Late Antiquity phase 2.

In its shape the bowl (Pl. 64: 8) imitates the bowls form Hayes 61 B, however it differs from them by its fabric. It was made from orange fired porous clay, with small additions of limestone and mica, and had no slip. The surface was powdery. It is an imitation of the Hayes 61 B bowl, which was in the Italic and eastern Alpine area a commonly copied form.<sup>12</sup> In Slovenia imitations of this form are known from Emona (Perko, Plesničar Gec 1992, 111, Pl. 4: 9) and Ajdovščina (Vidrih Perko, Žbona Trkman 2004, 282), while imitations of different forms have been discovered at Hrušica (Giesler 1981, Pl. 36: 7–10,20–21,39). Imitations were also found in Predjama.<sup>13</sup>

In Italy workshops that manufactured bowls imitating form Hayes 61 were found mainly in rural environments in central and southern Italy (Fontana 1998, 89–97). Local workshops which manufactured imitations of African products are assumed also north of the Alps, in the area of Raetia (Mackensen 1983, 202; Ladstätter 2000, 98, with the bibliography quoted there).

<sup>12</sup> In earlier literature the lack of slip on dishes that in their form and fabric show the characteristics of African manufacture was considered a criterion for defining the imitations of ARSW; however the lack of slip cannot be decisive for it can also be a result of the post-deposition processes (Ladstätter 2000, 98–99).

<sup>13</sup> Unpublished. I would like to thank V. Vidrih Perko for passing me this information.



## OŽJE NEOPREDELJENA AFRIŠKA SIGILATA

Odebeljeno ustje polkroglaste sklede (*t. 64: 9*) še najbolj ustreza obliki Hayes 99 (Hayes 1972, 152–155, t. 28: 1), vendar je zaradi majhnega in slabo ohranjenega odlomka uvrstitev le pogojna. Mogoče je tudi, da gre pri tem kosu za lokalno imitacijo. Po obliki je obravnavani fragment še najbliže varianti Hayes 99 C, morda tudi 80 B/99 (Bonifay 2004, sl. 180: 8).

Sklede Hayes 99 so na obravnavanem območju pogoste v Kopru na Kapucinskem vrtu (Cunja 1996, t. 10: 134–141; 11: 142–148). V Piranu sta bili najdeni tako skleda oblike Hayes 99 (Vidrih Perko 1994a, t. 1: 5) kot tudi 80 B/99 (Vidrih Perko 1994a, t. 1: 4), prav tako v Fizinah pri Portorožu (Gaspari et al. 2007, t. 8: 222,229). Oblika je bila priljubljena tudi na Invillinu (Mackensen 1987, 232–233, sl. 37: 9–12), varianta 80 B/99 je znana iz Concordije (Villa 2002, sl. 14). V notranjosti Slovenije izvira do sedaj edini znani primerek iz Kranja (Sagadin 2008, t. 19: 13).

Proizvodnja zgodnejših variant naj bi se začela okrog leta 450, največjo priljubljenost pa je oblika dosegla v 6. st. Najmlajše variante so datirane še v začetek 7. st. (Hayes 1972, 155; 1980, 516–517; Pröttel 1996, 55–56). Zadnje predlagane datacije so še poznejše, tako za varianto A predlagajo datacijo v 6. st., za varianto B v drugo polovico 6. in na začetek 7. st., za varianto C konec 6. in v 7. st., medtem ko naj bi bila pozna varianta 80 B/99 značilna za drugo polovico 7. st. (Bonifay 2004, 181).

Primer s Tonovcovega gradu je bil najden v stavbi 1, v plasti druge poznoantične faze.

Odebeljeno ustje (*t. 64: 11*) je zelo slabo ohranjeno in ga z gotovostjo ne moremo opredeliti. Približuje se obliki Hayes 87, predvsem varianti 87 C (Hayes 1972, 135–136, sl. 24), morda tudi prehodni varianti Hayes 87/109, vendar je tudi pri tem primerku uvrstitev zgolj pogojna. Oblika Hayes 87 velja za naslednika oblike 61 B. Hayes ga datira v zgodnje 6. st. (Hayes 1972, 136–137), Pröttel pa med leti 500 in 680 (Pröttel 1996, 87–88). Zadnje datacije njen začetek (prehodna varianta Hayes 87 C/109) postavljajo v zadnjo tretjino 6. st., medtem ko naj bi bila zadnja varianta 109 C značilna celo za drugo polovico 7. st. (Bonifay 2004, 189). Iz jugovzhodnoalpskega prostora je oblika znana z Vranja (Pröttel 1996, t. 6: 1), iz severnojadranskega pa iz Trsta (Zulini 2007a, 48, t. 8: 26–27). Fragment s Tonovcovega gradu je bil najden v ruševinski plasti stavbe 1.

V sondi pod estrihom severne cerkve je bilo najdeno tipološko ožje neopredeljivo dno afriške sigilate proizvodnje D (*t. 101: 3*). Morda gre za obliko Hayes 67 (Hayes 1972, 112–117), ki poleg oblike 61 B predstavlja eno od bolj razširjenih posod na obravnavanem prostoru. V jugovzhodnoalpskem prostoru so bile pogoste predvsem v drugi polovici 4. in na začetku 5. st. (Pröttel 1996, 47). Najdene so bile na Vranju (Pröttel 1996, t. 4: 12), Križni gori (Pröttel 1996, t. 6: 13), Polhograjski

## THE UNCLASSIFIED AFRICAN RED SLIP WARE

The thickened rim of the semi-globular bowl (*Pl. 64: 9*) is the closest to form Hayes 99 (Hayes 1972, 152–155, Pl. 28: 1), however due to the small and poorly preserved fragment this classification is merely conditional. It could also be a local imitation. According to its shape the fragment is the closest to variant Hayes 99 C, maybe even 80 B/99 (Bonifay 2004, Fig. 180: 8).

Bowls Hayes 99 are in the treated area common in Kapucinski vrt in Koper (Cunja 1996, Pls. 10: 134–141; 11: 142–148). In Piran a Hayes 99 (Vidrih Perko 1995a, Pl. 1: 5) and a 80 B/99 bowl were discovered (Vidrih Perko 1994a, Pl. 1: 4), as they were in Fazine near Portorož (Gaspari et al. 2007, Pl. 8: 222,229). Form Hayes 99 was popular also at Invillino (Mackensen 1987, 232–233, Fig. 37: 9–12), and the variant 80 B/99 was found in Concordia (Villa 2002, Fig. 14). In the Slovenian interior the only Hayes 99 example has been discovered in Kranj (Sagadin 2008, Pl. 19: 13).

The production of the earlier variants of this form are assumed to have started around the year 450, however the type reached its greatest popularity in the 6<sup>th</sup> century. The most recent variants are dated into the beginning of the 7<sup>th</sup> century (Hayes 1972, 155; 1980, 516–517; Pröttel 1996, 55–56). The last proposed dates place the form even later and suggest the 6<sup>th</sup> century for variant A, the second half of the 6<sup>th</sup> and beginning of the 7<sup>th</sup> century for variant B, the end of the 6<sup>th</sup> and 7<sup>th</sup> century for variant C, while the late variant 80 B/99 was supposedly characteristic for the second half of the 7<sup>th</sup> century (Bonifay 2004, 181).

The example from Tonovcov grad was discovered in building 1, in the layer of Late Antiquity phase 2.

The thickened rim (*Pl. 64: 11*) is extremely poorly preserved and cannot be ascribed to any type with certainty. It comes close to type Hayes 87, especially its variant 87 C (Hayes 1972, 135–136, Fig. 24), maybe also the intermediate form Hayes 87/109, however its categorisation into this group should be taken with reserve. Type 87 is believed to be the successor of type 61 B. Hayes dates it into the early 6<sup>th</sup> century (Hayes 1972, 136–137), while Pröttel dates it between 500 and 680 AD (Pröttel 1996, 87–88). The last dating of the beginning of this type (the predecessor type Hayes 87 C/109) is placed into the last third of the 6<sup>th</sup> century, while the last variant 109 C is characteristic for the 2<sup>nd</sup> half of the 7<sup>th</sup> century (Bonifay 2004, 189). In the South-eastern Alpine area an example was discovered at Vranje (Pröttel 1996, Pl. 6: 1), while in the North Adriatic area this form was found in Trieste (Zulini 2007a, 48, Pl. 8: 26–27). The rim from Tonovcov grad was found in the destruction layer of building 1.

In the trench under the mortar floor in the north church an African Red Slip Ware base of D-production was discovered, however it is impossible to categorise

gori (Pröttel 1996, t. 9: 13), Hrušici (Pröttel 1996, t. 16: 18–25), v Ajdovščini (Pröttel 1996, t. 23: 1–7), Povirju (Pröttel 1996, t. 27: 11–13), na Rodiku (Pröttel 1996, t. 28: 6) in Školaricah (Žerjal 2008, 93, 472–474).

Dni na *t. 65*: 1–2 tipološko nista opredeljivi. Obe izvirata iz območja stavbe 1, iz ruševinskih plasti.

#### 4.1.2 AFRIŠKE OLJENKE IN NJIHOVE IMITACIJE

Afriške oljenke so zelo pogosta najdba na pozno-antičnih najdiščih Slovenije, Furlanije, dalmatinske, istrske in severnoitalijanske jadranske obale (Mackensen 1987, 244, op. 101, s tam citirano literaturo). Njihova razprostranjenost je povezana z razprostranjenostjo afriške sigilate, saj je šlo pogosto za izdelke istih delavnic. Na obravnavanem območju so pogoste tudi imitacije afriških oljenk.

Hayes je postavil osnovno razdelitev afriških oljenk in določil dva oblikovna tipa s po dvema podtipoma, ki temeljita predvsem na kvaliteti izdelave in okrasa (Hayes 1972, 310–315). Hayesovo delitev sta poglobila Anselmino in Pavolini (Atlante I, 184–207). Njunjo delitev je pri svoji objavi delavnic iz El Mahrine v Tuniziji uporabil tudi Mackensen, ki jo je nekoliko prilagodil in dopolnil (Mackensen 1993, 95–96). Oljenke, najdene na območju Slovenije in severnega Jadrana, je zbral Pröttel (1996, 71–81). Zadnjo tipološko in kronološko členitev je postavil Bonifay (2004, 312–430).

Za oljenke, do sedaj najdene na Tonovcovem gradu, smo zaradi njihovega majhnega števila in slabe ohranjenosti uporabili dopolnjeno Hayesovo klasifikacijo. Najdeni so bili ostanki štirih oljenk, vsi v stavbi 1.

Oljenka (*t. 65*: 3) je izdelana iz fino prečiščene, oranžno žgane gline in ima delno ohranjen premaz. Okras na rami je geometrijski, zaporedno si sledijo koncentrični krogi in rombi, zapolnjeni s koncentričnimi krogi. Druga oljenka (*t. 65*: 4) je ravno tako izdelana iz fino prečiščene, oranžno žgane gline, premaz pa ni ohranjen. Na ramenu si sledijo rozete in polni trikotniki.

Obe lahko kljub fragmentarni ohranjenosti pripišemo klasičnemu tipu severnoafriških oljenk (Hayes II A/Atlante 10). Zanje so značilni od telesa jasno ločen nos s kanalom in luknjo za stenj, profilirana stojna ploskev in poševno postavljen koničast držaj, pa tudi značilen žigosan ornament. Po fakturi in kvaliteti izdelave okrasa je Hayes ločil dva podtipa. Tako naj bi bili za tip II A značilni fino prečiščena glina, tanek, gladek premaz in natančno izdelan okras, za tip II B pa bolj groba faktura in premaz ter slabše izdelan okras (Hayes 1972, 311).

Datacija oljenk tipa Hayes II A se pri različnih avtorjih precej razlikuje. Hayes jih je datiral v čas od 420–500 (Hayes 1972, 313), Mackensen pa je njihovo datacijo na podlagi oljenke s Hrušice (Giesler 1981, t. 44: 5) sprva postavil v osemdeseta leta 4. st. (Mackensen

it more precisely (*Pl. 101*: 3). It could be form Hayes 67 (Hayes 1972, 112–117), which alongside type 61 B represents one of the more diverse shapes in the discussed area. In the Southeastern Alps this type of vessels was common especially during the second half of the 4<sup>th</sup> and beginning of the 5<sup>th</sup> century (Pröttel 1996, 47). The vessels were found at Vranje (Pröttel 1996, Pl. 4: 12), Križna gora (Pröttel 1996, Pl. 6: 13), Polhograjska gora (Pröttel 1996, Pl. 9: 13), Hrušica (Pröttel 1996, Pl. 16: 18–25), in Ajdovščina (Pröttel 1996, Pl. 23: 1–7), Povir (Pröttel 1996, Pl. 27: 11–13), at Rodik (Pröttel 1996, Pl. 28: 6) and Školarice (Žerjal 2008, 93, 472–474).

It is impossible to typologically categorise the bases on *Pl. 65*: 1–2. Both originate from the destruction layers of building 1.

#### 4.1.2 AFRICAN OIL LAMPS AND THEIR IMITATIONS

African oil lamps are a common find on Late Antique sites in Slovenia, Friuli, as well as along the Dalmatian, Istrian and North Italian Adriatic coast (Mackensen 1987, 244, note 101, with the literature quoted there). Their distribution is linked to the distribution of African Red Slip Ware, for they were often products from the same workshops. Imitations of African oil lamps are also common in the discussed area.

Primarily Hayes divided African oil lamps into two shapes with two subtypes, which are differentiated mainly according to the quality of the fabric and decoration (Hayes 1972, 310–315). Hayes' division was expanded upon by Anselmino and Pavolini (Atlante I, 184–207). A slightly adjusted and expanded version of their division was used by Mackensen in his publication on ARSW and oil lamp workshops from El Mahrine in Tunisia (Mackensen 1993, 95–96). Pröttel gathered the oil lamps that were found in Slovenia and the North Adriatic (Pröttel 1996, 71–81). The last typological and chronological division was established by Bonifay (2004, 312–430).

Due to the low number and poor condition of the oil lamps discovered at Tonovcov grad we used the updated Hayes classification. We have found remains of four oil lamps, all of them in the area covered by building 1.

The oil lamp (*Pl. 65*: 3) was manufactured from fine purified orange fired clay and has a partially preserved slip. The decoration on the shoulder is geometric, a combination of concentric circles and rhombuses filled with concentric circles. The second oil lamp (*Pl. 65*: 4) was also manufactured from fine purified orange fired clay, however the slip is not preserved. On the shoulder we can see a line of rosettes and filled-in triangles.

Regardless of the fragmented preservation both can be categorised as classic North African oil lamps (Hayes II A/Atlante 10). Characteristic for them are: a long nozzle

1987, 244–245). V zadnjem obdobju je kot najverjetnejša sprejeta datacija začetka izdelave okrog leta 400 (Mackensen 1993, 159; Pröttel 1996, 79; Ladstätter 2000, 102). Vsekakor pa so bile oljenke tega tipa najpogostejše v 5. st., njihova uporaba pa sega še v 6. st., vendar je bila takrat že v upadanju.

Oljenka (*t. 65: 5*) ima okras izveden veliko slabše kot prej omenjeni. Izdelana je iz nekoliko bolj grobe gline, na nekaterih mestih je še opazen premaz. Okras je izveden nekakovostno, verjetno gre za neko vrsto rastlinskega okrasa. Glede na slabo izvedbo pripada verjetno tipu Hayes II B/Atlante 11, ki se umešča v čas od druge polovice 5. st. do leta 550 (Hayes 1972, 314). Pröttel domneva začetek izdelave tipa Hayes II B od leta 530 dalje (prva razvojna faza), medtem ko naj bi najmlajše razvojne oblike sodile v 7. st. (Pröttel 1996, 81). Obravnavana oljenka po svojih značilnostih sodi v prvo razvojno fazo.

Zadnja oljenka (*t. 65: 6*) se od ostalih treh razlikuje po fakturi in izvedbi okrasa. Izdelana je iz rumenkasto žgane, dokaj slabo prečiščene, rahlo porozne gline. Premaz ni ohranjen, tudi okras je nerazpoznaven. Glede na opisano je verjetno, da pri tej oljenki ne gre za afriški izvor, ampak za lokalni posnetek.<sup>14</sup>

Posnetki afriških oljenk so v vsem mediteranskem prostoru zelo pogosti. Na območju severnega Jadrana domnevajo delavnice imitiranih afriških oljenk v Raveni in Akvileji (Berti 1983, 147; Pröttel 1996, 107, op. 21–23, s tam citirano literaturo).

Za območje severnega Jadrana in Slovenije je bilo tako mogoče definirati pet skupin imitiranih oljenk (Pröttel 1996, 107–108). Zaradi slabe ohranjenosti obravnavanega primerka je zanesljiva uvrstitev nemogoča, glede na fakturo pa je najbližje skupini 1 (skupina Ajdna) oz. skupini 3 (skupina Invillino) po Pröttlu (1996, 107).

Začetek izdelovanja imitacij oljenk tipa Hayes II v severnojadranskem prostoru je postavljen v čas po sredini 5. st. (skupina Ajdna), mlajše skupine pa trajajo do sredine 7. st. (Pröttel 1996, 108).

Vse oljenke izvirajo iz izkopnega polja stavbe 1. Oljenka *t. 67: 4* je bila najdena v plasti prve poznoantične faze, oljenki *t. 65: 3,5* v plasteh druge poznoantične faze, oljenka *t. 65: 6* pa v premešani humusni plasti.

#### 4.1.3 AFRIŠKA NAMIZNA KERAMIKA

Poleg sigilate je na tržišča v Evropi prihajalo tudi manj kvalitetno namizno in kuhinjsko posodje afriškega izvora. Na Tonovcovem gradu lahko v to skupino pogoj-

<sup>14</sup> Pri določitvah lokalnih imitacij je treba biti previden posebno pri poznih oblikah oljenk, saj so tudi nekatere pozne oblike Hayes II B, ki izvirajo iz Afrike, izdelane iz grobe, porozne gline, s slabim premazom in s slabo izvedenim okrasom. V tem primeru slaba kvaliteta ne pomeni lokalnega izvora, ampak pozno datacijo (Pröttel 1996, 12).

with a broad straight channel that is clearly separated from the discus, a profiled base, a slanting and pointy handle and the typical stamp ornament. Hayes distinguished between two subtypes as regards the fabric and quality of decorations. Fine purified clay, a thin smooth slip and a precisely made decoration were typical for type II A, while type II B was better known for its rough fabric and slip and poorer decoration (Hayes 1972, 311).

Various authors use different dates for the Hayes II A oil lamps. Hayes dated them between 420 and 500 (Hayes 1972, 313), while Mackensen at first dated them in the 380s (Mackensen 1987, 244–245) using the oil lamp from Hrušica as his base (Giesler 1981, Pl. 44: 5). Recently it has been believed that the most likely date for the beginning of its manufacture is around 400 AD (Mackensen 1993, 159; Pröttel 1996, 79; Ladstätter 2000, 102). We can state with certainty that this type of oil lamps was most common in the 5<sup>th</sup> century, and remained in use in the 6<sup>th</sup> century, even though its popularity was on the decline.

The decoration on the oil lamp (*Pl. 65: 5*) is much poorer than on the previously mentioned one. It is made from slightly rougher clay and in some places the slip can still be noticed. The decoration is not of high quality, most likely it represents some sort of vegetation. Taking into account the poor craftsmanship it most likely belongs to type Hayes II B/Atlante 11, dated between the 2<sup>nd</sup> half of the 5<sup>th</sup> century and 550 AD (Hayes 1972, 314). Pröttel assumed that type Hayes II B was first manufactured sometime after 530 AD (first development phase), and that the latest development phases belonged to the 7<sup>th</sup> century (Pröttel 1996, 81). The characteristics of the discussed oil lamp clearly place it into the first development phase.

The last oil lamp (*Pl. 65: 6*) differs from the rest by its fabric and decoration. It is made from yellowish, relatively poorly purified, slightly porous clay. The slip is not preserved, and the decoration is unrecognisable. Taking all of this into account we could assume that it is not of African origin, but a local imitation.<sup>14</sup>

African oil lamp imitations are common throughout the Mediterranean. It is assumed that workshops that imitated African oil lamps in the northern Adriatic were located in Ravenna and Aquileia (Berti 1983, 147; Pröttel 1996, 107, note 21–23, with the literature quoted there).

Five groups of imitations have been classified in the North Adriatic area and Slovenia (Pröttel 1996, 107–108). Due to the poor condition of the example it is impossible to precisely categorise the discussed object, however taking into account its craftsmanship it is clos-

<sup>14</sup> When defining local imitations one has to be especially careful with the later forms of oil lamps, for some late Hayes II B forms manufactured in Africa were produced from rough, porous clay, had a poor slip and a poorly executed decoration. In this case the poor quality is not a consequence of a local workshop but of a late date (Pröttel 1996, 12).

no uvrstimo skledo z visečim robom *t. 65: 7*, ki bi jo po obliki lahko pripisali skledam oziroma melnicam tipa Fulford 22 (Fulford, Peacock 1984, sl. 63: 22) oziroma Bonifay 13 (Bonifay 2004, sl. 139).<sup>15</sup> Opredelitev ni popolnoma zanesljiva zaradi slabe ohranjenosti fragmenta, ki je bil tudi poškodovan v ognju.

Tip je bil široko razširjen v zahodnem Sredozemlju (Bonifay 2004, 255–257), dokaj pogost pa tudi v jugovzhodnoalpskem prostoru. Zastopan je v Akvileji (Chinelli 1994, t. 44: CCda 1–2,4; CCda 6,9–12,14,16–17,19), Trstu (Degrassi et al. 2007, sl. 3: 18; 4: 30,36), v zadnjem času je bil prepoznan v Ajdovščini (Vidrih Perko, Žbona Trkman 2004, sl. 8: 1–8), Navportu (Horvat 1990, t. 19: 2), na Sv. Pavlu nad Vrtovinom (Svoljšak 1985, t. 5: 819), v Emoni (neobjavljeno, omemba Vidrih Perko, Žbona Trkman 2005, 284, op. 60) in v Fizinah pri Portorožu (Gaspari et al. 2007, 181, t. 6: 161,163–164; 9: 248).

Tovrstno posodje je okvirno datirano v 5. st. (Bonifay 2004, 258; Gaspari et al. 2007, 181).

Obravnavana skleda je bila najdena v stavbi 1 v plasteh druge poznoantične faze.

#### 4.1.4. LATE ROMAN C (FOKEJSKA SIGILATA)

V stavbi 3 je bil v premešani humusni plasti najden zelo slabo ohranjen fragment sklede z masivnim, rahlo visečim robom (*t. 100: 1*). Premaz ni ohranjen. Skleda verjetno pripada vzhodnosredozemski, tako imenovani LRC proizvodnji (Hayes 1972, 323) ali njeni imitaciji.<sup>16</sup>

Začetek te proizvodnje na izvornem območju sega v konec 4. st. V 5. st. je skoraj povsem izpodrinila afriške importe v vzhodnem Sredozemlju (Hayes 1972, 323–349), razširjena pa je bila tudi v njegovem zahodnem delu (Reynolds 1995, 35). V drugi polovici 5. in v 6. st. je pogosta tako na severnojadranskih obalnih najdiščih kot tudi v notranjosti (Martin 1998, sl. 6; Gandolfi 1999, 424–425, sl. 2).

Hayes je proizvodnjo LRC razdelil na 10 tipov s podtipi (Hayes 1972, 325–326), vendar se zunaj maloazijskega prostora v glavnem pojavljajo le tipi 3 in 10. Določanje variant je včasih težko. V obravnavanem primeru gre za obliko z dokaj masivnim, le rahlo navzdol potegnjenim ustjem, ki bi jo lahko uvrstili v tip 3F oziroma 3G po Hayesu. V obeh primerih gre za dokaj pozno obliko, na jugovzhodnoalpskem območju značilno za prvo polovico 6. st. (Pröttel 1996, 91).

<sup>15</sup> Bonifay je v tip 13 združil Fulfordova tipa 22 in 23 (2005, 255–258, sl. 139).

<sup>16</sup> Izdelava tega posodja je bila najprej dokazana v okolici mesta *Phocaea* na maloazijski obali, zato se danes vse bolj uveljavlja tudi izraz fokejska sigilata (Hayes 1980, 525–526; Martin 1998, 109–110), čeprav so jo verjetno izdelovali na širšem območju (Mackensen 1987, 235–236, op. 37).

est to group 1 (the Ajdna group) or group 3 (the Invillino group) as defined by Pröttel (1996, 107).

The beginning of the production of Hayes II oil lamps in the northern Adriatic was dated after the mid 5<sup>th</sup> century (the Ajdna group), while the latest groups were produced as late as the mid 7<sup>th</sup> century (Pröttel 1996, 108).

All oil lamps were discovered in the excavation area of building 1. Oil lamp *Pl. 67: 4* was discovered in the layer of Late Antiquity phase 1, oil lamps *Pl. 65: 3,5* were discovered in the layers of Late Antiquity phase 2 and oil lamp *Pl. 65: 6* was discovered in the mixed humus layer.

#### 4.1.3 AFRICAN TABLEWARE

The markets in Europe also imported lower quality African table and kitchen ware. At Tonovcov grad the bowl with the hanging rim *Pl. 65: 7* can be conditionally classified into this group, for its shape could be said to resemble a Fulford 22 (Fulford, Peacock 1984, Fig. 63: 22) or Bonifay 13 bowl (Bonifay 2004, Fig. 139).<sup>15</sup> Due to the poor condition of the fragment, which has also been damaged in the fire, this classification is not entirely reliable.

This type is widespread in the west Mediterranean (Bonifay 2004, 255–257) and relatively common in the Southeastern Alps. It has been found in Aquileia (Chinelli 1994, Pls. 44: CCda 1–2,4; CCda 6,9–12,14,16–17,19), Trieste (Degrassi et al. 2007, Figs. 3: 18; 4: 30,36), and recently in Ajdovščina (Vidrih Perko, Žbona Trkman 2004, Fig. 8: 1–8), Nauportus (Horvat 1990, Pl. 19: 2), at Sv. Pavel above Vrtovin (Svoljšak 1985, Pl. 5: 819), in Emona (unpublished, mentioned by Vidrih Perko, Žbona Trkman 2005, 284, note 60) and Fazine near Portorož (Gaspari et al. 2007, 181, Pls. 6: 161,163–164; 9: 248).

These bowls have been roughly dated into the 5<sup>th</sup> century (Bonifay 2004, 258; Gaspari et al. 2007, 181).

The bowl was discovered in building 1, in the layers of Late Antiquity 2 phase.

#### 4.1.4. LATE ROMAN C (PHOCAEAN RED SLIP WARE)

The layer of humus in building 3 revealed a poorly preserved fragment of a bowl with a massive, slightly hanging rim (*Pl. 100: 1*). The slip is not preserved. The bowl is most likely of an eastern Mediterranean, so called LRC production (Hayes 1972, 323) or its imitation.<sup>16</sup>

<sup>15</sup> Bonifay merged Fulford types 22 and 23 into type 13 (2005, 255–258, Fig. 139).

<sup>16</sup> The production of these dishes was first discovered in the vicinity of the town of Phocaea on the Asia Minor coast, which is why the term Phocaeian Red Slip Ware has been lately gaining in popularity (Hayes 1980, 525–526; Martin 1998, 109–110). However, it is assumed that it was manufactured in a broader area (Mackensen 1987, 235–236, note 37).

Posode oblike LRC 3 so bile najdene na Križni gori (Urleb 1974, t. 42: 5; Vidrih Perko 1994b, Križna gora, t. 3: 1; Pröttel 1996, t. 6: 14,16), Sv. Pavlu (Svoljšak 1985, t. 5: 81; Pröttel 1996, t. 6: 7), Invillinu (Mackensen 1987, sl. 38: 7–13) in v Maranu (Villa 1998, sl. 2: 1). V notranjosti so poznane iz Črnomlja (Vidrih Perko 1994b, Črnomelj, t. 2: 4–5; Mason 1998, t. 4: 5–6), s Tinja (Pröttel 1996, 90–91, 203; Ciglencečki 2000, t. 12: 3), Svetih gor (P. Korošec in J. Korošec jr. 1978, t. 7: 1) in Sv. Heme (Ladstätter 2000, t. 3: 11; 4: 1–4). Na večini obravnavanih najdišč posodje LRC nastopa skupaj z vzhodnomediterranskimi amforami in poznimi malimi spatejoni.

#### 4.1.5 GLAZIRANA KERAMIKA

Začetek izdelave poznoantične glazirane keramike v podonavskem prostoru sega v konec 3. oziroma na začetek 4. st.,<sup>17</sup> sredi 4. st. pa je prišla v množično uporabo na širokem območju od Dakije na vzhodu do Norika in Recije na zahodu, posamezni primerki pa so bili najdeni tudi v Franciji in Angliji (Arthur 1985, t. 1). Poleg podonavskih delavnic so glazirano posodje izdelovale tudi delavnice v Reciji (npr. Mautern v Avstriji; Friesinger, Kerchler 1981; Friedberg-Stätzling v bližini Augsburga v Nemčiji; Ebner 1997; pregled za Švico: Ettlinger 1977) in v Italiji (Ravena: Maioli 1983, 114; Magrini, Sbarra 2005). V severnojadranskem prostoru je bila proizvodnja glaziranega posodja doslej ugotovljena v Carlinu pri Akvileji (Bertacchi 1976, 182–194; Magrini, Sbarra 2005), kjer je delavnica v 4. in na začetku 5. st. proizvajala glazirano posodje za širši trg. Kasneje se je njena proizvodnja zmanjšala, za lokalni trg pa je proizvajala še v 6. st (Magrini, Sbarra 2005, 65–66).<sup>18</sup>

V drugi polovici 4. st. je glazirana keramika sodila med tipičen inventar vojaških postojank v jugovzhodnih Alpah. Pogosta je bila na Hrušici (Giesler 1981, t. 41), Martinj hribu (Leben, Šubic 1990, t. 14: 238–239; 15: 245–256) in v Ajdovščini (Vidrih Perko, Žbona Trkman 2005, 282).

Ostale višinske naselbine se po oskrbi z glazirano keramiko med sabo močno razlikujejo. Dokaj pogosta je na vzhodnonoriškem območju, tako je zastopana na Tinju (Ciglencečki 2000, t. 10: 1–9; 11: 1–13), Vranju (Knific 1979, sl. 203–204, 206–207) in Kučarju (J. Dular, Ciglencečki, A. Dular 1995, t. 46: 1–2; 80: 3; 83: 17; 84: 16; 85: 1–3). Najdena je bila tudi na Ančnikovem gradišču (Strmčnik 1997, t. 4: 12; Ravnik 2006, t. 2: 6–13; 3:

<sup>17</sup> Vprašanje neposredne kontinuitete med zgodnje- in poznorimsko produkcijo je še odprto (Ladstätter 2000, op. 696). Pri poznoantični glazirani keramiki gre za popolnoma drugo skupino, ki nima razen obdelave površine nič skupnega z zgodnjeantično produkcijo na tem prostoru (Cvjetičanin 2001, 81; 2006).

<sup>18</sup> Proizvodnja v 6. st. se domneva tudi za podonavski prostor (Cvjetičanin 1994, 29).

The beginning of this production in the area of origin reaches back to the end of the 4<sup>th</sup> century. In the 5<sup>th</sup> century it managed to almost entirely substitute the African imports to the eastern Mediterranean (Hayes 1972, 323–349), and was also widespread in the west Mediterranean (Reynolds 1995, 35). In the second half of the 5<sup>th</sup> and 6<sup>th</sup> century it was commonly found in North Adriatic ports as well as in the interior (Martin 1998, Fig. 6; Gandolfi 1999, 424–425, Fig. 2).

Hayes classified LRC production into 10 types with subtypes (Hayes 1972, 325–326), however only types 3 and 10 appeared outside of Asia Minor. Sometimes it is hard to define the exact subtype. The treated example with a relatively large, slightly downturned rim could be placed into type 3F or 3G in the Hayes classification. Both examples belong to the relatively late form that was typical for the first half of the 6<sup>th</sup> century in the Southeastern Alps (Pröttel 1996, 91).

The vessels LRC 3 were found at Križna gora (Urleb 1974, Pl. 42: 5; Vidrih Perko 1994b, Križna gora, Pl. 3: 1; Pröttel 1996, Pl. 6: 14,16), Sv. Pavel above Vrtovin (Svoljšak 1985, Pl. 5: 81; Pröttel 1996, Pl. 6: 7), Invillino (Mackensen 1987, Fig. 38: 7–13) and in Marano (Villa 1998, Fig. 2: 1). In the hinterland they are known from Črnomelj (Vidrih Perko 1994b, Črnomelj, Pl. 2: 4–5; Mason 1998, Pl. 4: 5–6), Tinje (Pröttel 1996, 90–91, 203; Ciglencečki 2000, Pl. 12: 3), Svete gore (P. Korošec and J. Korošec jr. 1978, Pl. 7: 1) and from Hemmaberg (Ladstätter 2000, Pls. 3: 11; 4: 1–4).

In most of the mentioned sites LRC dishes appear together with east Mediterranean amphorae and late small spatheia.

#### 4.1.5 GLAZED POTTERY

The beginnings of the production of Late Antique glazed pottery in the Danubian area reaches into the end of the 3<sup>rd</sup> or beginning of the 4<sup>th</sup> century.<sup>17</sup> In the mid 4<sup>th</sup> century it became used in greater numbers in the wider area spanning from Dacia in the east to Noricum and Raetia in the west, and individual examples were found as far west as France and England (Arthur 1985, Pl. 1). Glazed pottery was also produced in other Raetian (e.g. Mautern in Austria; Friesinger, Kerchler 1981; Friedberg-Stätzling in the vicinity of Augsburg in Germany; Ebner 1997; overview for Switzerland: Ettlinger 1977) and Italian workshops (Ravenna: Maioli 1983, 114; Magrini, Sbarra 2005). In the north Adriatic area the production of glazed pottery was ascertained in Carlinu near Aquileia

<sup>17</sup> The issue of direct continuity between Early Roman and Late Roman production remains open (Ladstätter 2000, note 696). Late Antique glazed pottery represents an entirely different group, which does not have anything in common with the Early Antique production in this area (apart from the surface working; Cvjetičanin 2001, 81; 2006).

14–28) in Korinjskem hribu (Modrijan 2009, sl. 2). Zelo pogosta je na Sv. Hemi, kjer predstavlja drugo najštevilčnejšo skupino posodja, takoj za grobo keramiko, in ima tudi zelo široko paleto oblik in okrasov (Ladstätter 2000, t. 5–9). V večini primerov je bila najdena v plasteh pod zahodnimi cerkvami in med njimi, ki so na podlagi afriških importov datirane v 5. st. (Ladstätter 2000, 118–130). Oblike glazirane keramike, zastopane na omenjenih najdiščih, so večinoma sklede, melnice in vrčki, kažejo pa navezavo na podonavske produkcijske centre.

Na zahodnem delu obravnavanega območja je glazirana keramika redkejša, tako ni bila najdena na Invillinu in Castelraimodu, redka pa je tudi na Teurniji (Ladstätter 2000, 129, op. 768), Kirchbichlu (Rodriguez 1986, t. 63: 29) in Šenturški gori (Ladstätter 2000, op. 770). Nekaj primerkov je bilo najdenih na Ajdni.<sup>19</sup>

Tudi na Tonovcovem gradu glazirana keramika ni bila pogosta. V stavbi 1 so bile najdene tri glazirane posode (t. 65: 8–10), ena na območju med osrednjo in južno cerkvijo (t. 101: 4) in ena v stavbi 3 (t. 100: 3).

Skoraj v celoti je ohranjen lonček (t. 65: 8), katerega deli so bili najdeni tako v plasteh prve kot druge poznoantične faze. Izdelan je bil iz gline, mešane z drobnozrnatim peskom, oranžno žgane na zunanji in notranji strani, jedro je oranžno-sivo-oranžno. Lošč olivno zelene barve je ohranjen na zunanji in notranji strani. Okrašen je z enojno valovnico na vratu in kanelurami nad in pod njo.

Najbližje analogije obravnavanemu lončku najdemo med gradivom delavnice v Carlinu, med lončki skupine 2 (predvsem 2B), za katere sta značilna trebušasta oblika in izvihano ustje, razlikuje pa se po odsotnosti ročaja, ki je značilen za primerke iz Carlina (Magrini, Sbarra 2005, 43–44, t. 23–24, predvsem t. 23: 3; 24: 2). Različne oblike vrčkov in lončkov so v severni Italiji dokaj pogoste tudi v grobovih 4. in 5. st. (Maccabruni 1990, 367; Brogiolo, Gelichi 1992, 25). Tako je bila na najdišču Castelseprio najdena skupina lončkov z izvihanim ustjem, premera od 6,5 do 11 cm (Lusuardi Siena, Sannazaro 1985, 33–34, t. 3: 2; Lusuardi Siena, Sannazaro 1992, t. 1: 6,9,11), ki so oblikovno zelo podobni našemu lončku. Podobni so znani tudi iz poznorimskih nekropol v okolici Vareseja in z najdišč v kantonu Ticino (Lusuardi Siena, Sannazaro 1992, 33–34, op. 5).

Pojav okrasa valovnice na glazirani keramiki je (skupaj z nekaterimi drugimi okrasnimi motivi) postavljen v panonskem prostoru v konec 4. in na začetek 5. st. (Bónis 1991, 144). Pogost je predvsem na robovih melnic in skled, pojavlja pa se tudi na različnih tipih loncev in vrčev (Magrini, Sbarra 2005, t. 16: 1,3; 17).

Drugi ohranjeni primerki z območja stavbe 1 je odlomek lonca z izvihanim ustjem iz oranžno žgane, v jedru oranžno-sivo-oranžne gline (t. 65: 9) s slabo ohranjenim svetlo rjavim loščem, tretji pa odlomek ravnega dna tipološko ožje nedoločljive posode (t. 65:

(Bertacchi 1976, 182–194; Magrini, Sbarra 2005), where a workshop in the 4<sup>th</sup> and beginning of the 5<sup>th</sup> century manufactured glazed pottery for a broader market. Later on its production declined, however it remained producing pottery for the local market as late as the 6<sup>th</sup> century (Magrini, Sbarra 2005, 65–66).<sup>18</sup>

In the second half of the 4<sup>th</sup> century glazed pottery was a part of the typical inventory of military posts in the Southeastern Alps. As such it was common at Hrušica (Giesler 1981, Pl. 41), Martinj hrib (Leben, Šubic 1990, Pls. 14: 238–239; 15: 245–256) and in Ajdovščina (Vidrih Perko, Žbona Trkman 2005, 282).

The remaining hilltop settlements differ greatly as regards glazed pottery. It is relatively common in the East Noricum area, where it was found at Tinje (Ciglencečki 2000, Pls. 10: 1–9; 11: 1–13), Vranje (Knific 1979, Figs. 203–204, 206–207) and Kučar (J. Dular, Ciglencečki, A. Dular 1995, Pls. 46: 1–2; 80: 3; 83: 17; 84: 16; 85: 1–3). It was very common at Hemmaberg, where it represented the second most numerous pottery group, immediately after coarse ware, and where it also shows a wide palette of forms and decorations (Ladstätter 2000, Pl. 5–9). Most of it was discovered in the layers between and under the west churches, which were dated into the 5<sup>th</sup> century (based on the African imports; Ladstätter 2000, 118–130). It was also discovered at Ančnikovo gradišče (Strmčnik 1997, Pl. 4: 12; Ravnik 2006, Pls. t. 2: 6–13; 3: 14–28) and Korinjski hrib (Modrijan 2009, Fig. 2). Most of the glazed pottery discovered at the aforementioned sites were bowls and jugs, which indicates a connection with the Danubian production centres.

Glazed pottery is rare in the west part of the discussed area, thus none was found at Invillino or Castelraimondo, and it was also rare at Teurnia (Ladstätter 2000, 129, note 768), Kirchbichel (Rodriguez 1986, Pl. 63: 29) and Ulrichsberg (Ladstätter 2000, note 770). A few examples were found on Ajdna.<sup>19</sup>

Glazed pottery was rare also on Tonovcov grad. Three glazed pottery pieces were found in building 1 (Pl. 65: 8–10), one within the area between the main and south church (Pl. 101: 4), and one in building 3 (Pl. 100: 3).

A small pot (Pl. 65: 8), pieces of which were found in layers of Late Antiquity phase 1 as well as in layers of Late Antiquity phase 2 was almost entirely preserved. It was made from clay, mixed with fine sand, orange fired on the outer and inner side, and orange-grey-orange in core. The olive green glaze is preserved on the outer and inner side. It is decorated with a single wavy line on the neck with horizontal grooves above and below.

The closest analogy to the discussed pot can be found amongst the material from the workshop in Carlinu,

<sup>18</sup> 6<sup>th</sup> century production is also assumed for the Danubian area (Cvjetičanin 1994, 29).

<sup>19</sup> Unpublished, I would like to thank V. Vidrih Perko for the information.

<sup>19</sup> Neobjavljeno, za informacijo se zahvaljujem V. Vidrih Perko.

10), ki ima na zunanji strani ohranjene skromne ostanke zelenorjavega lošča.

Deli lončka s *t. 65: 8* so bili najdeni v plasteh prve poznoantične faze, deli pa tudi v plasteh druge poznoantične faze in v ruševinskih plasteh. To kaže na njegovo uporabo v času prve poznoantične faze, med gradnjo stavbe 1 pa je bil uničen.

Ostanki glaziranega lončka so bili najdeni tudi v maltnih plasteh na območju med osrednjo in južno cerkvijo (*t. 101: 4*). Gre za verjetno dvoročajni (ohranjeni so samo ostanki enega ročaja), bikonični lonec z rahlo izvihanim odebeljenim ustjem, ki je pod klekom na trebuhu okrašen z linijo poševnih vbodov. Izdelan je iz gline, mešane z drobnozrnatim peskom, oranžno žgan, v jedru oranžno-sivo-oranžen. Tudi za to obliko najdemo najbližje analogije v Carlino, kjer ustreza tipu lonca z ročajem 1B (Magrini, Sbarra 2005, t. 49). Taka oblika v Italiji sicer ni bila pogosta, znana pa je iz podonavskega prostora (Magrini, Sbarra 2005, op. 177, 178). Pojav okrasa z linijo vbodov v Panoniji je datiran v konec 4. st. (Bónis 1991, 144).

Eno slabo ohranjeno ustje glaziranega lončka je bilo najdeno tudi v stavbi 3 (*t. 100: 3*). Po obliki ustja je podobno zgoraj obravnavanemu lončku (*t. 101: 4*).

Glazirano posodje iz stavbe 1 lahko postavimo v čas prve poznoantične faze. Nekoliko drugače je z bikoničnim lončkom, okrašenim z vbodi (*t. 101: 4*), ki je bil najden na območju cerkvenega sklopa v plasteh druge poznoantične faze, torej v času, ko naj bi se oskrba višinskih naselbin z glaziranimi izdelki v glavnem že nehala. Ker so severnoitalske delavnice proizvajale (sicer v zmanjšanem obsegu) tudi še v 6. st., bi bila zaradi njihove relativne bližine mogoča tudi datacija v ta čas. Nasproti tej tezi pa govori relativno velika podobnost fature lončka *t. 101: 4* z lončkom iz stavbe 1 (*t. 65: 8*), ki po legi sodi v čas prve poznoantične faze. Tako je vseeno verjetnejša datacija lončka iz prostora med osrednjo in južno cerkvijo v konec 4. in prvo polovico 5. st.

Oblike glaziranega posodja s Tonovcovega gradu kažejo predvsem na severnoitalski prostor, čeprav so nekatere znane tudi iz Podonavja. Na izdelke iz Carlina spominja tudi faktura. Glina s primesmi drobnozrnatega peska in oranžnordeča barva sta namreč značilnosti carlinske delavnice. Teze, da je verjeten izvorni center za glazirano keramiko s Tonovcovega gradu prav Carlino, pa ni potrdila mineraloško-petrografska analiza dveh lončkov (*t. 65: 8* in *t. 101: 4*), saj je pokazala, da sta si oba vzorca relativno podobna in ju lahko pripišemo istemu produkcijskemu območju, vendar pa se od vzorcev iz Carlina nekoliko razlikujeta (Capelli, Cabella, Piazza 2009, 71–74). Kljub temu je verjeten podoben (torej severnoitalski) izvor. Zadnje analize namreč kažejo, da naj bi na območju severne Italije delovalo več manjših proizvodnih centrov, ki so izdelovali podobne izdelke v isti lokalni tradiciji (Capelli, Cabella, Piazza 2009, 74).

amongst the pots from group 2 (especially 2B), for which a rounded shape and an everted rim are typical. However, this example does not have the handle typical for the examples from Carlino (Magrini, Sbarra 2005, 43–44, Pls. 23–24, especially Pls. 23: 3; 24: 2). In Northern Italy jugs and pots were also common in graves dated to the 4<sup>th</sup> and 5<sup>th</sup> century. Thus a group of similarly designed pots with an everted rim and a diameter ranging between 6.5 and 11 cm appears at the site of Castelseprio (Lusuardi Siena, Sannazaro 1985, 33–34, Pl. 3: 2; Lusuardi Siena, Sannazaro 1992, Pl. 1: 6,9,11). Similar pottery has also been discovered in the Late Roman cemeteries in the vicinity of Varese and at the sites in the canton of Ticino (Lusuardi Siena, Sannazaro 1992, 33–34, note 5).

In the Pannonian area the decoration with wavy lines appears on glazed pottery (together with some other decorative motifs) at the end of the 4<sup>th</sup> and the beginning of the 5<sup>th</sup> century (Bónis 1991, 144). It is especially common on the edges of mortaria and bowls, and it also appears on other types of pots and jugs (Magrini, Sbarra 2005, Pls. 16: 1,3; 17).

The second preserved example from the excavation area of building 1 is a fragment of an orange fired pot with an everted rim. The core is orange-grey-orange (*Pl. 65: 9*) and is covered by a poorly preserved light brown slip. The third example is a fragment of a flat base that cannot be precisely defined typologically (*Pl. 65: 10*), however, on the outer side we can see traces of the modestly preserved green-brownish glaze.

Parts of the jug from *Pl. 65: 8* were discovered in Late Antiquity 1 layers, and other parts in Late Antiquity 2 layers, or in the destruction layers. This indicates that the jug was used during the Late Antiquity 1 phase, and was destroyed during the construction of building 1.

The remains of a glazed jug were also found in the mortar layers between the main and south church (*Pl. 101: 4*). This is most likely a double handle (only the remains of a single handle are preserved), biconical jug with a slightly everted rim and a decoration of slanting impressions on the body. It is made from clay, mixed with fine sand, orange fired, and orange-grey-orange in core. The closest analogy to this shape most likely originates in Carlino, where it fits the type of the single handle pot 1B (Magrini, Sbarra 2005, Pl. 49). This shape is uncommon in Italy, but better known in the Danubian area (Magrini, Sbarra 2005, note 177, 178). In Pannonia the decoration with the line of slanting impressions is dated into the end of the 4<sup>th</sup> century (Bónis 1991, 144).

One poorly preserved rim of a glazed jug was also found in building 3 (*Pl. 100: 3*). Its rim is of a similar shape as the one from the previously discussed jug (*Pl. 101: 4*).

Glazed pottery from building 1 can be dated into the Late Antiquity 1 phase. Somewhat different is the example of the biconical pot, decorated with slanting impressions (*Pl. 101: 4*), that was found in the area between the main and south church in the Late Antiquity 2 layers. This

Na splošno lahko rečemo, da je količina glazirane keramike na Tonovcovem gradu skromna, kaže pa navezavo na produkcijo severnoitalijanskega prostora, čeprav najbližja znana delavnica v Carlino po rezultatih analiz ni bila njen izvorni center. Pri tem je treba poudariti, da večina oblik iz Carlina ni zastopana niti v bližnji Akvileji, prav tako glazirana keramika ni bila najdena nekaterih severnoitalijanskih višinskih postojankah, kot sta npr. Castelraimondo in Invillino. Delavnica v Carlino naj bi proizvajala predvsem izdelke za širše območje, ne pa za lokalni trg. Kot mogoč prejemnik za izdelke iz Carlina je bilo predpostavljeno območje *Claustra Alpium Iuliarum* (Magrini, Sbarra 2005, 63–66), vendar pa je pregled glazirane keramike s Hrušice, iz Ajdovščine in z Martinj hriba pokazal, da zaenkrat področja poznoantičnih zapor ne moremo določiti kot prejemnika izdelkov iz Carlina (Magrini, Sbarra 2009, 86).<sup>20</sup>

Široka razprostranjenost glaziranih izdelkov, ki so bili najdeni predvsem v vojaških kontekstih, ter dokajšnja standardizacija oblik in fature kaže, da gre pri tovrstni keramiki za namensko proizvodnjo za potrebe vojske (Arthur, Williams 1981, 503–504; Cvjetičanin 1997, 19; 2001; 2006; Magrini, Sbarra 2005, 71–73), čeprav je posebno v zadnjem času vse več najdb glaziranega posodja tudi v civilnih kontekstih. Verjetno je bila vsaj na začetku, v prvi polovici 4. st., povezava z vojsko res močna, kasneje pa je del tega posodja prešel tudi v civilno rabo kot tekmeč sigilatnemu (Vidrih Perko, Žbona Trkman 2004) oziroma kot nadomestilo zanj, saj je uvoz sigilate v 5. st. že usihal.

#### 4.1.6 NEOPREDELJENA NAMIZNA KERAMIKA

Med inventarjem stavbe 1 je zastopanih nekaj vrčkov in lončkov, ki sodijo v skupino namizne keramike. Gre za posode, ki zaradi svoje fature niso bile primerne za uporabo na ognju in so se pretežno uporabljale za shranjevanje in serviranje hrane. Na Tonovcovem gradu v to skupino sodi posodje svetle (rumene do oranžne) barve, z večinoma dobro prečiščeno, na otip kredasto fakturo. Pri večini lahko na podlagi fature domnevamo severnojadranski izvor.<sup>21</sup>

Med vrči izstopata dva enoročajna vrčka z izvihanim ustjem in iz ustja izvlečenim ročajem (t. 65: 11–12)

<sup>20</sup> Mineraloško-petrografska analiza vzorcev iz Carlina, s Tonovcovega gradu, iz Carnunta (*Castrum Legionis* in Jupitrovo svetišče), Vindobone in Akvinka (grobišče Budimpešta – Gazdagrét) je pokazala, da je na vzhodnoalpskem in podonavskem območju moralo obstajati več manjših centrov za proizvodnjo glaziranega posodja, hkrati pa majhne razlike v fakturi in premazu kažejo na zelo enotno tehnološko znanje (Capelli, Cabella, Piazza 2009, 74; Magrini, Sbarra 2009, 86).

<sup>21</sup> Delavnice za tovrstno posodje se domnevajo v Akvileji (Chinelli 1994, 266) in na območju severne Istre (Žerjal 2008, 180, 196–197).

is already a period during which the supply of glazed products to hilltop settlements had more or less finished. As North Italic workshops kept producing such pottery in the 6<sup>th</sup> century (albeit in reduced quantities) it seems possible – due to their relative closeness – to date it into this period. In opposition to this thesis is the relatively similar fabric of pot *Pl. 101: 4* and the pot from building 1 (*Pl. 65: 8*). The stratigraphic position of this pot dates it into Late Antiquity 1 phase. Thus it is more likely that also pot from the area between the main and south church is dated into the end of the 4<sup>th</sup> or first half of the 5<sup>th</sup> century.

The forms of glazed pottery at Tonovcov grad indicate that most of it came from the North Italic workshops, even though some forms are known also in the Danubian area. The fabric is also reminiscent of products from Carlino. Clay with additions of fine sand and the orange-red colour is characteristic of the Carlino workshop. The thesis that Carlino supplied Tonovcov grad with glazed pottery was not confirmed by the mineralogical and petrographic analysis of the two pots (*Pl. 65: 8* and *Pl. 101: 4*). The analysis indicated that both examples were relatively similar and that both originated from the same production area, however they differ slightly from the examples from Carlino (Capelli, Cabella, Piazza 2009, 71–74). However, it most likely has a similar (i.e. North Italic) origin. The latest analysis shows that a number of smaller production centres operated in North Italy, and they all manufactured similar products in the similar local tradition (Capelli, Cabella, Piazza 2009, 74).

In general we can say that glazed pottery at Tonovcov grad was found in modest numbers, and that it shows links with the North Italic production. However, according to the results of the analysis, this pottery did not originate from the closest known workshop in Carlino. At this it should be stressed that most forms manufactured in Carlino were not found even in nearby Aquileia, and that no glazed pottery was found on hilltop posts in the North Italy, such as for instance Castelraimondo and Invillino. It is assumed that the workshop in Carlino produced objects for the broader area and not for the local market. *Claustra Alpium Iuliarum* was considered to be a possible destination point for the products from Carlino (Magrini, Sbarra 2005, 63–66), however the overview of glazed pottery from Hrušica, Ajdovščina and Martinj hrib has shown that this was not the case (Magrini, Sbarra 2009, 86).<sup>20</sup>

<sup>20</sup> The mineralogical-petrographic analysis of the examples from Carlino, Tonovcov grad, Carnuntum (*Castrum Legionis* and Jupiter's temple), Vindobona and Aquincum (the burial site Budapest – Gazdagrét) has shown that glazed pottery was most likely produced in numerous small centres in the eastern Alps and the Danubian area. At the same time the small differences in the fabric and glaze indicate unified technological knowledge (Capelli, Cabella, Piazza 2009, 74; Magrini, Sbarra 2009, 86).



iz svetlo žgane, fino prečiščene gline. Podobni vrči so znani s Hrušice (Giesler 1981, t. 40: 24).

Vrčka (*t. 66: 4–5*) s prstanasto odebeljenim ustjem nekoliko spominjata na obliko malih amforic spatejov.<sup>22</sup> Izdelana sta iz fino prečiščene, svetlo rjavo žgane gline z dodatkom sljude.

Vrčkoma (*t. 66: 6–7*) oblikovno najbližje vzporednice najdemo v Kopru, v skupini osmih vrčkov s svitkastim ustjem (Cunja 1996, t. 29: 320–327), vendar se faktura koprskih primerkov približuje fakturi severnoafriških amfor (Cunja 1996, 119–120), medtem ko je vrček *t. 66: 6* izdelan iz zelo fino prečiščene gline z dodatkom sljude. Skupina podobno profiliranih ustij je bila najdena tudi na Invillinu. Šlo naj bi za regionalen tip, razširjen predvsem v Benečiji in Furlaniji (Mackensen 1987, 258–259, sl. 46), vendar se podobni vrčki pojavljajo tudi na drugih italijanskih najdiščih (npr. San Antonino v Liguriji, prim. Murialdo et al. 1998, 242–244, sl. 6: 7–8).

Tordiran ročaj vrča (*t. 66: 14*) je izdelan iz bež žgane, fino prečiščene, na otip kredaste gline. Na območju Slovenije so tordirani ročaji znani z obalno-kraških najdišč. Analogije zanje najdemo na Sv. Pavlu nad Vrtovinom (Svoljšak 1985, t. 8: 138), v Kopru (Vidrih Perko 1994b, Koper, Kidričeva ulica, t. 1: 6; Kajfež, Josipovič 2000, t. 6: 10) in Štanjelu (Vidrih Perko 1994b, Štanjel, t. 1: 7; Vidrih Perko 1997b, sl. 5: 19). Tordirani ročaji vrčev so bili sicer pogosti v poznorimskem obdobju, pojavljali pa so se tudi pri glazirani keramiki (Tokod: Bónis 1991, sl. 8: 11, 137–138; Carlino: Magrini, Sbarra 2005, t. 40).

Ostanek ostenja z okrasom vrezanih linij (*t. 66: 11*) je izdelan iz zelo trdo žgane, v jedru sive gline, ohranjen je močan oranžen premaz.

Poleg tega je bilo v stavbi 1 najdenih še precej spodnjih delov posod. Predstavljen je le manjši izbor, ki kaže, da gre v glavnem za tipološko nedoločljiva ravna dna, nekateri primerki so tudi rahlo usločeni (*t. 66: 16–18*). Pri vseh primerkih gre za lončke, izdelane iz fino prečiščene, svetlo rjavo žgane gline, pogosto z dodatkom sljude in s kredasto površino.

Vrči in lonci, ki sodijo v skupino navadne namizne keramike, so bili na območju stavbe 1 večinoma najdeni v plasteh prve poznoantične faze, le nekaj – očitno kot rezidualni kosi – jih je bilo v plasteh 6. st.

Na območju med osrednjo in južno cerkvijo je bilo iz prve poznoantične faze najdenih več zelo slabo ohranjenih lončkov, glede na fakturo so italskega izvora. En primerek (*t. 101: 5*) ima ohranjen oranžen premaz.

#### 4.1.7 AMFORE

Amfore so transportno posodje, prilagojeno ladijskemu prometu, v njih so prevažali tekoče (olje, vino, ribje omake ...) in razsute (žito, semena, suho sadje)

<sup>22</sup> Razlikovanje med malimi amforami in vrčki je pri zelo majhnih odlomkih težko.

The widespread glazed pottery that was found predominantly in military contexts, and the relative standardisation of shapes and fabrics indicates that such pottery was intentionally produced for the military use (Arthur, Williams 1981, 503–504; Cvjetičanin 1997, 19; 2001; 2006; Magrini, Sbarra 2005, 71–73), even though lately increasing numbers of glazed pottery have also been found in civil contexts. It is likely that the connection with the military was strong in the beginning (in the first half of the 4<sup>th</sup> century), but later on a part of this pottery found its way into civil use where it represented competition to African Red Slip Ware (Vidrih Perko, Žbona Trkman 2004) or a substitute for it, for the imports of ARSW on the decline throughout the 5<sup>th</sup> century.

#### 4.1.6 UNCLASSIFIED TABLEWARE

The inventory in building 1 revealed a few jugs and pots that could be categorised as tableware. These were vessels that could not be used on the fireplace (due to their fabric) and were mostly used for storing and serving food. At Tonovcov grad this group consisted of bright coloured vessels (yellow to orange), with a mainly purified, powdery fabric. In most cases the fabric indicates a north Adriatic origin.<sup>21</sup>

Two jugs with everted rims and single handles that emerge from these rims stand out (*Pl. 65: 11–12*). They were made from brightly fired, finely purified clay. Similar jugs were also discovered at Hrušica (Giesler 1981, Pl. 40: 24).

The jugs with a ring thickened rim (*Pl. 66: 4–5*) are slightly reminiscent of the small amphorae – spatheia.<sup>22</sup> They were made from finely purified light brown fired clay with mica additions.

The closest parallels to the two jugs (*Pl. 66: 6–7*) can be found in Koper, in the group of eight jugs with ring rims (Cunja 1996, Pl. 29: 320–327). However, the fabric of the Koper examples is closer to the fabric used for the North African amphorae (Cunja 1996, 119–120), while jug *Pl. 66: 6* was made from finely purified clay with the addition of mica. A group with similarly profiled rims was also found at Invillino. This is assumed to be a regional type that was especially widespread across Friuli (Mackensen 1987, 258–259, Fig. 46), however similar jugs appear also in other Italian sites (e.g. San Antonino in Liguria, cf. Murialdo et al. 1998, 242–244, Fig. 6: 7–8).

The twisted jug handle (*Pl. 66: 14*) was made from beige fired, finely purified, powdery clay. In Slovenia such handles were discovered in coastal and Karst sites.

<sup>21</sup> The workshops which produced such pottery are assumed to have been in Aquileia (Chinelli 1994, 266) and north Istria (Žerjal 2008, 180, 196–197).

<sup>22</sup> With small fragments it is hard to differentiate between small amphorae and jugs.

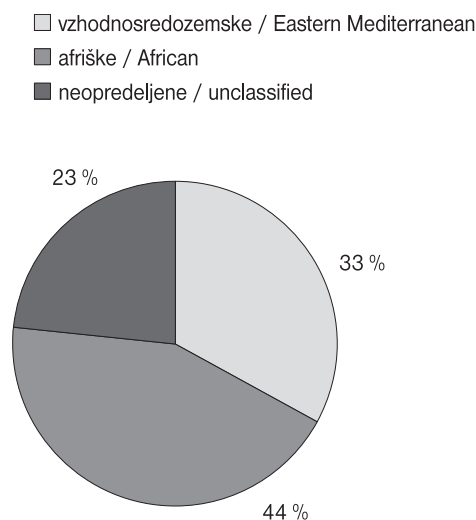

Sl. 4.4. Zastopanost afriških, vzhodnosredozemskih in neopredeljenih amfor glede na število vseh najdenih kosov.

Fig. 4.4: Representation of African amphorae, Eastern Mediterranean amphorae and unclassified amphorae according to the number of all fragments.

prehrambene izdelke (Vidrih Perko 2000). Tesno so povezane z gospodarstvom (kmetijstvom, prometom, trgovino), pa tudi z vojsko (oskrba čet) in državno davčno politiko (Reynolds 1995, 106–125).

V poznoantičnem obdobju, ko je bilo težišče kmetijske pridelave v afriških provincah ter v vzhodno-sredozemskem (maloazijskem in sirsko-palestinskem) prostoru, sta prevladovali dve veliki skupini amfor, ki se med seboj ločita po obliki in fakturi, to so afriške in vzhodnosredozemske amfore.

Na Tonovcovem gradu je bilo najdenih 632 odlomkov amfor. 44 % jih je bilo na podlagi fakture z dokajšnjo gotovostjo opredeljenih kot afriške, 33 % kot vzhodnosredozemske, 23 % pa je ostalo neopredeljenih (sl. 4.4). Glede na težo je odstotek afriških amfor še večji, saj v skupni teži vseh najdenih amfor na najdišču dosega 58 % (sl. 4.5).<sup>23</sup>

#### AFRIŠKE AMFORE

Konec 3. in v začetku 4. st. je tržišča imperija preplavila keramika (poleg amfor tudi sigilata in oljenke), ki so jo izdelovali v severnoafriških provincah. Večina raziskovalcev množičen pojav afriške keramike povezuje z uvedbo anone (Fullford, Peacock 1984, 256–257,

<sup>23</sup> Pri tem naj bi bile količine afriških amfor v keramičnih skupkih po navadi celo podcenjene, ker so afriški tipi slabše razpoznavni od vzhodnih. Po drugi strani pa je vsaj pri teži treba upoštevati, da gre pri obravnavanih amforah za tipe velikih dimenzij z debelimi ostenji, ki so v povprečju težje od vzhodnomediterranskih.

The analogies for them can be found at Sv. Pavel above Vrtovin, (Svoljšak 1985, Pl. 8: 138), in Koper (Vidrih Perko 1994b, Koper, Kidričeva ulica, Pl. 1: 6; Kajfež, Josipovič 2000, Pl. 6: 10) and Štanjel (Vidrih Perko 1994b, Štanjel, Pl. 1: 7; Vidrih Perko 1997b, Fig. 5: 19). Twisted jug handles are a common appearance during the Late Roman period, and they can also be found amongst glazed pottery (Tokod: Bónis 1991, Fig. 8: 11, 137-138; Carlino: Magrini, Sbarra 2005, Pl. 40).

The remnant of the wall with the grooved decoration (Pl. 66: 11) was made from hard fired grey clay, and also has a preserved orange slip.

Numerous pottery bases were also found in building 1. Only a small selection is represented, and this selection shows that we are mostly dealing with typologically indefinable flat bases, while some are slightly concave (Pl. 66: 16-18). All examples are fragments of jugs, made from finely purified, light brown fired clay, often with the addition of mica and with a powdery surface.

In the excavation area of building 1 jugs and pots that can be categorised amongst coarse tableware were mostly found in Late Antiquity 1 layers, only a few – obviously residual pieces – were found in the layers belonging to the 6<sup>th</sup> century.

In the area between the main and south church a number of poorly preserved jugs were found in the Late Antiquity 1 layer, and their fabric revealed that they were of Italic origin. On one example (Pl. 101: 5) the remains of orange slip were preserved.

#### 4.1.7 AMPHORAE

Amphorae are vessels used for transporting liquids (oil, wine, fish sauces, etc.) and scattered (wheat, seeds, dried fruit) goods, especially adapted for ship transport (Vidrih Perko 2000). They were closely linked to the economy (agriculture, transport, trade), the military (supplying the troops) and state tax policy (Reynolds 1995, 106-125).

In Late Antiquity, when the main agricultural centres were located in the African provinces and the East Mediterranean (Asia Minor and the Syrian – Palestine area), two large groups of amphorae (African and Eastern Mediterranean) which differed in their fabric and shape dominated.

632 amphorae fragments were found at Tonovcov grad. On the basis of the fabric 44 % of them were categorised as African, 33 % as Eastern Mediterranean, while 23 % remained uncategorised (Fig. 4.4). Taking into account the weight the share of African amphorae is even greater, for they reach 58 % in the total weight of all discovered amphorae (Fig. 4.5).<sup>23</sup>

<sup>23</sup> At this the quantities of African amphorae in the pottery clusters were usually underrated, as the African types are harder to classify than the East Mediterranean. On the other

- vzhodnomediterranske / Eastern Mediterranean
- afriške / African
- neopredeljene / unclassified

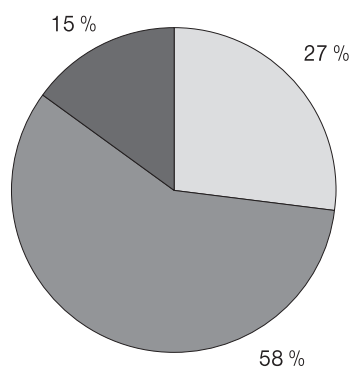

Sl. 4.5: Zastopanost afriških, vzhodnosredozemskih in neopredeljenih amfor glede na težo vseh najdenih kosov.

Fig. 4.5: Representation of African amphorae, Eastern Mediterranean amphorae and unclassified amphorae according to the weight of all fragments.

Reynolds 1995, Vidrih Perko 2000, 435), nekaj afriškega blaga pa je na trg prihajalo tudi kot posledica zasebne pobude (Reynolds 1995, 106–112; Stone 2009, 144–146).

V amforah so v pristanišča imperija, potem pa tudi v notranjost, prihajali pridelki cvetočega afriškega kmetijstva. V starejši literaturi je (predvsem na podlagi pisnih virov) prevladovalo mnenje, da so v njih prevajali predvsem olje, ki je imelo veliko vlogo v afriškem gospodarstvu (zbrano pri Bonifay 2004), novejša raziskava pa kažejo tudi na ostale proizvode. Tako naj bi bila posmoljena notranjost indikator za prevoz vina in ribjih izdelkov (ribje omake, soljene ribe), saj za prevoz olja smoljenje ni bilo potrebno (Bonifay, Piéri 1995). Verjeten je tudi prevoz žita, ki je imelo prav tako pomemben delež v severnoafriškem izvozu (Bonifay 2004, 479).

Proizvodnja afriških amfor je trajala, kot kažejo novejša raziskovanja velikih depozitov (predvsem smetišč) v zahodnem Sredozemlju, še v 7. st. (Keay 1998, 142–143).<sup>24</sup> To velja tako za male pozne spatejone tipov Keay 26 F, G, H, kot tudi za pozne serije tunizijskih cilindričnih amfor (t. i. vandalske), ki so datirane od sredine 5. do začetka 7. st. (Freed 1995, 155–156), in nekatere oblike poznih malih spatejonov, datiranih celo v drugo polovico 7. st. (Bonifay 2004, 129–130). Vandalska kriza sredi 5. st. torej ni pomenila prekinitve afriške proizvodnje, je pa

<sup>24</sup> Raziskana so bila tako proizvodna območja v osrednji Tuniziji, izvozni centri v severni Tuniziji kot tudi potrošni centri na vzhodni španski, francoski in zahodni italijanski obali. Raziskave kažejo precejšnje kronološke razlike med izvornimi in potrošnimi območji in pa, da so amfore preživele precej faz uporabe in ponovnega depozita, preden so končno postale "arheološki zapis" (Keay 1998, 142–143).

#### AFRICAN AMPHORAE

At the end of the 3<sup>rd</sup> and beginning of the 4<sup>th</sup> century the markets in the Roman Empire were flooded by pottery (amphorae, Red Slip Ware and oil lamps) that was produced in the North African provinces. Most authors link the mass appearance of African pottery with the introduction of the *annona* (Fullford, Peacock 1984, 256–257; Reynolds 1995; Vidrih Perko 2000, 435), while some African goods arrived on the market also as a result of private initiatives (Reynolds 1995, 106–112; Stone 2009, 144–146).

Amphorae were used to deliver products of the blooming African agriculture to the various ports across the Empire and further into the interior. In earlier literature (predominantly using literary sources as their base) the opinion prevailed that they were used predominantly to transport oil, for this had an important role in the African economy (collected in Bonifay 2004), however, newer research indicates that they were also used to transport other products. If the interior was covered in resin this was an indicator that wine or fish products (fish sauces, salted fish) were transported in the amphorae, for it was not necessary to apply a resin layer for the transport of oil (Bonifay, Piéri 1995). The transport of wheat is also likely, for it represented an important share of the North African exports (Bonifay 2004, 479).

The newer research of large sites (especially dumps) in the West Mediterranean indicates that the production of African amphorae continued into the 7<sup>th</sup> century (Keay 1998, 142–143).<sup>24</sup> This holds true for the small late spatheia types Keay 26 F, G, H, as well as for the late series of the Tunisian cylindrical amphorae (so called Vandal type), all of which were dated between the mid 5<sup>th</sup> and the beginning of the 7<sup>th</sup> century (Freed 1995, 155–1256). Some forms of late small spatheia date as late as the second half of the 7<sup>th</sup> century (Bonifay 2004, 129–130). The Vandal crisis (in the mid 5<sup>th</sup> century) did not stop the African production; however it did bring changes to the way it was made. It slightly reduced the trade and rerouted some merchant routes (Peacock, Bejaoui, Belazreg 1989, 199–201; Reynolds 1995, 112–116), which consequentially led to the domination of Eastern Mediterranean amphorae in the late 5<sup>th</sup> and 6<sup>th</sup> century sites in the Mediterranean and its hinterland. However, regardless of the decline in their production the African provinces remained an im-

hand it has to be taken into account that the African amphorae are large and have thick walls and are thus heavier than the Eastern Mediterranean examples.

<sup>24</sup> Production areas in central Tunisia, export centres in north Tunisia, as well as consumer centres on the east Spanish, French and west Italian coasts were researched. The research showed large chronological differences between the areas of origin and consummation. It was also discovered that the amphorae went through quite a few phases of use and reuse, before they became an 'archaeological record' (Keay 1998, 142–143).

vnesla spremembe v njen način, nekoliko zmanjšala obseg trgovine in preusmerila nekatere trgovske poti (Peacock, Bejaoui, Belazreg 1989, 199–201; Reynolds 1995, 112–116), kar je posledično pripeljalo do prevlade vzhodnosredozemskih amfor na najdiščih poznega 5. in 6. st. v Sredozemlju in v zaledju. Vendar pa so afriške province kljub upadu proizvodnje še naprej ostajale pomemben izvoznik živilskih proizvodov, kar se je kazalo tudi v razvoju nekaterih novih oblik amfor, kot so bili npr. pozni mali spatejoni, široko razširjeni v Sredozemlju in notranjosti (Reynolds 1995, 119–120).

Za afriške amfore je značilna trda, raskava, slabo prečiščena glina oranžne, oranžnordeče ali oranžnorjave barve. Površina je lahko prevlečena z gostim, belkastim premazom. Trup je večinoma cilindrične oblike in se končuje z masivno, podolgovato konico, rame je konično, vrat pa cilindrično oblikovan. Profilacija ustij je zelo raznolika, kar v primerih, ko imamo ohranjena samo ustja, zelo otežuje podrobnejšo tipološko opredelitev afriških amfor.

Tudi na Tonovcovem gradu so bile nekatere afriške amfore zaradi fragmentarne ohranjenosti opredeljene zgolj okvirno. Večino vseh afriških amfor, najdenih na Tonovcovem gradu, predstavljajo odlomki ostenj, ki tipološko niso opredeljiva.

Večina afriških amfor je bila najdena v izkopnem polju stavbe 1, večinoma v plasteh, ki pripadajo prvi poznoantični fazi. Edina izjema je v celoti ohranjen mali pozni spatejon (sl. 4.6; t. 101: 7) iz prezbitერიja osrednje cerkve.

#### Africana II (*africana grande*, Keay 4-7)

Najzgodnejši afriški import na Tonovcovem gradu predstavljajo velike cilindrične amfore skupine africana II, imenovane tudi *africana grande*. Skupina je bila na podlagi bogatih najdb iz Ostije razdeljena na štiri podskupine (Africana II A–II D: Panella 1973; Manacorda 1977). Bonifay je obdržal osnovno razdelitev, dodal pa še variante vsakega tipa (Bonifay 2004, 107–119, sl. 57–62).

Na Tonovcovem gradu smo v to skupino uvrstili dve amfori.

Amfora s poudarjenim robom (t. 67: 1) sodi v tip Keay 6/Africana II C (Panella 1973, 586–592; Keay 1984, 118–121, sl. 45: 6–7; Bonifay 2004, 114–115, sl. 113). Obravnavani primer ustreza poznim oblikam tega tipa (Bonifay II C 3), datiranim v 4. st. (Bonifay 2004, 115). V amforah africana II C naj bi prevajali predvsem ribje izdelke (Bonifay 2004, 472).<sup>25</sup> V Sloveniji sta bili amfori tega tipa najdeni

<sup>25</sup> Amfora je po drugi strani (predvsem zaradi značilne stopnice na notranjem robu) blizu tudi tipu Keay 57 – Bonifay 42 (Keay 1984, 298, sl. 128; Bonifay, Piéri 1995, sl. 3: 18; Bonifay 2004, 135–136, sl. 73: 2). Amfore Keay 57 so poznene, datirane so v drugo polovico 5. in 6. st. (Keay 1984, 299–300) oziroma v drugo polovico 5. st. (Bonifay 2004, 137). Vendar pa je za tip 57 značilen tudi okras glavničenja na vratu, ki ga obravnavani primerek nima.

portant exporter of food products. This is clearly shown in the development of some new amphorae types, such as for instance the late small spatheia, which were widely popular across the Mediterranean and in the interior (Reynolds 1995, 119–120).

African amphorae are known for their hard, coarse, poorly purified orange, orange-red or orange-brown clay. The surface can be coated by a thick, white slip. The body is usually cylindrical and ends in a massive, prolonged base, the shoulder is conical, and the neck cylindrical. As there are so many different rim types it is extremely hard to typologically categorise the African amphorae when only rims are preserved.

On Tonovcov grad some African amphorae were classified only indicative (due to their fragmentation). Most African amphorae discovered at Tonovcov grad are represented by wall fragments that cannot be typologically classified.

Most African amphorae were discovered in the excavation area of building 1, mostly in Late Antiquity 1 layers. The only exception is represented by the small late spatheion (Fig. 4.6; Pl. 101: 7) discovered in the presbytery of the main church.

#### Africana II (*africana grande*, Keay 4-7)

The earliest African imports at Tonovcov grad are represented by the large cylindrical amphorae belonging to the group Africana II, also known as *africana grande*. Based on the rich finds from Ostia the group was divided into four subgroups (Africana II A–II D: Panella 1973; 1974; Manacorda 1977). Bonifay kept the basic division, and added variants to each type (Bonifay 2004, 107–119, Figs. 57–62).

At Tonovcov grad two amphorae belong to this group.

The amphora with the pronounced rim (Pl. 67: 1) is categorised as type Keay 6/Africana II C (Panella 1973, 586–592; Keay 1984, 118–121, Fig. 45: 6–7; Bonifay 2004, 114–115, Fig. 113). The discussed example belongs to the late forms of this type (Bonifay II C 3), dated into the 4<sup>th</sup> century (Bonifay 2004, 115).<sup>25</sup> This form was supposedly used to transport fish products (Bonifay 2004, 472). In Slovenia they were also found in Most na Soči (Vidrih Perko 1994b, Most na Soči, Sv. Lucija, Pl. 1: 2) and at Školarice (Žerjal 2008, Pl. 41: 114,118). It was found in the layer of the Late Antiquity 1 phase.

<sup>25</sup> On the other hand this amphora is close to type Keay 57 – Bonifay 42 (Keay 1984, 298, Fig. 128; Bonifay, Piéri 1995, Fig. 3: 18; Bonifay 2004, 135–136, Fig. 73: 2), especially with its characteristic step on the inner rim. Amphorae type Keay 57 are late, for they are dated into the second half of the 5<sup>th</sup> and 6<sup>th</sup> century (Keay 1984, 299–300), or into the second half of the 5<sup>th</sup> century (Bonifay 2004, 137). However, type 57 is also known for its combed decoration on the neck which the discussed example lacks.

še na Mostu na Soči (Vidrih Perko 1994b, Most na Soči, Sv. Lucija, t. 1: 2) in na Školaricah (Žerjal 2008, t. 41: 114,118). Najdena je bila v plasti, ki pripada prvi poznoantični fazi.

Amforo na t. 67: 2 lahko uvrstimo v tip Keay 7/africana II D, za katerega je značilno navpično postavljeno, ravno ustje, od vratu ločeno z žlebom (Keay 1984, 121, sl. 46, 47; Bonifay 2004, 115–118, sl. 62). Ker ustje na zunanji strani ni odebeljeno, amfora ustreza Bonifayevi varianti africana II D 2. Amfore africana II D 2 naj bi proizvajali od sredine 3. st., višek njihove uporabe pa sega v prvo tretjino 4. st. (Panella 1973, 588–589; Manacorda 1977, 168; Bonifay 2004, 117). Tudi v njih naj bi v glavnem prevažali ribje izdelke (*salsamenta*), mogoče tudi vino in olje (Bonifay 2004, 117, 474). Obravnavana amfora je bila kot residualna najdba najdena v zgodnje-srednjeveški plasti (Tonovcov grad. Naselbinski ostanki in interpretacija, sl. 3.19: 18).

Amfora africana II D predstavlja eno najpogostejših oblik v Akvileji (Zulini 2007b, 157, op. 1483, s tam citirano literaturo), znana je tudi iz Trsta (Zulini 2007b, 157, t. 34: 79), s Školaric (Žerjal 2008, t. 41: 1122,1123) in Invillina (Mackensen 1987, t. 45: 7).

### Tripolitanske amfore

En najden odlomek ustja (t. 67: 3) lahko pripišemo amfori tripolitanske proizvodnje tipa tripolitana III/Bonifay 20, ki so jih od sredine 2. st. dalje izdelovali v okolici mesta *Leptis Magna* (Panella 1973; Bonifay 2004, 105, sl. 55b). Obravnavani odlomek pripada njeni pozni obliki z značilno odebeljenim robom ustja ter grobo, v jedru oranžno-sivo-oranžno fakturo (Peacock 1984, 18, faktura 2.8; Bonifay 2004, 105).

V Ostiji in Rimu se bile tripolitanske amfore v množični uporabi v drugi polovici 3. in prvi polovici 4. st., njihova pozna varianta tje prevladovala v Ostiji v kontekstih sredine 4. st. (Panella 2001, 211; Bonifay 2004, 105). V njih so prevažali oljčno olje (Bonifay 2004, 107, 474).

Tripolitanske amfore v Sloveniji sicer niso pogoste. Ena je bila najdena na Ptuju (Vidrih Perko 1994b, Ptuj, t. 1: 2–3), nekaj na Hrušici (Vidrih Perko 2000, 442) in nekaj na Školaricah (Žerjal 2008, 138, t. 43: 1153–1154). Iz bližnjega prostora so znane še iz Akvileje (Donat 1991, 226–227, AA 37–39; 1994a, 414–415, AA 2–4), Julije Konkordije (*Iulia Concordia*) in Trsta (Masselli Scotti et al. 2004, 74–75; Zulini 2007b, 162, t. 35: 88).

### Keay 25

Na Tonovcovem gradu lahko z dokajšnjo gotovostjo prepoznamo nekaj amfor, ki sodijo v veliko skupino cilindričnih amfor srednjih dimenzij (*contentitori cilindrici della tarda età imperiale*: Manacorda 1977,

The amphora on Pl. 67: 2 can be categorised as type Keay 7/Africana II D, which is known for its straight sided rim, separated from the neck by a groove (Keay 1984, 121, Figs. 46–47; Bonifay 2004, 115–118, Fig. 62). As the rim is not thickened on the outer side, the amphora can be placed in Bonifay's variant Africana II D 2. Such amphorae were produced from the mid 3<sup>rd</sup> century onwards and reached their peak in the first third of the 4<sup>th</sup> century (Panella 1973, 588–589; Manacorda 1977, 168; Bonifay 2004, 117). Mostly they were used for transporting fish products (*salsamenta*), possibly also wine and oil (Bonifay 2004, 117, 474). The discussed amphora was found (as a residual find) in the Early Medieval layer (Tonovcov grad. Settlement remains and interpretation, Fig. 3.19: 18).

Amphora Africana II D is one of the most common forms in Aquileia (Zulini 2007b, 157, note 1483, with the literature quoted there), and is also known in Trieste (Zulini 2007b, 157, Pl. 34: 79), at Školarice (Žerjal 2008, Pl. 41: 1122,1123) and Invillino (Mackensen 1987, Pl. 45: 7).

### Tripolitanian amphorae

One of the discovered rim fragments (Pl. 67: 3) can be categorised as type tripolitana III/Bonifay 20, which was manufactured from the mid 2<sup>nd</sup> century onwards in the vicinity of the town *Leptis Magna* (Panella 1973; Bonifay 2004, 105, Fig. 55b). The discussed fragment belongs to the late form of tripolitana III with the characteristically everted rim and coarse fabric, in core of orange-grey-orange colour (Peacock 1984, 18, fabric 2.8; Bonifay 2004, 105).

In Ostia and Rome tripolitanian amphorae appear in large quantities during the second half of the 3<sup>rd</sup> and first half of the 4<sup>th</sup> century, while in Ostia the late variants dominate in the mid 4<sup>th</sup> century contexts (Panella 2001, 211; Bonifay 2004, 105). This amphora type was used to transport olive oil (Bonifay 2004, 107, 474).

Tripolitanian amphorae are not very common in Slovenia. One was found in Ptuj (Vidrih Perko 1994b, Ptuj, Pl. 1: 2–3), a few at Hrušica (Vidrih Perko 2000, 442) and a few at Školarice (Žerjal 2008, 138, Pl. 43: 1153–1154). In the vicinity a few were discovered in Aquileia (Donat 1991, 226–227, AA 37–39; 1994a, 414–415, AA 2–4), Iulia Concordia and Trieste (Masselli Scotti et al. 2004, 74–75; Zulini 2007b, 162, Pl. 35: 8).

### Keay 25

On Tonovcov grad we can recognise some amphorae that belong into the large group of medium sized cylindrical amphorae (*contentitori cilindrici della tarda età imperiale*: Manacorda 1977, 171–185), typical representatives of which are amphorae type Keay 25 (Keay

171–185), katerih značilni predstavniki so amfore tipa Keay 25 (Keay 1984, 184–212). Te vrste amfor so se razvile iz zgodnejših afriških oblik, npr. oblike *africana grande* (*africana* II), in so hkrati predhodnice velikih cilindričnih amfor poznega 5. in zgodnjega 6. st., zato zanje Bonifay predlaga poimenovanje *africana* III (Bonifay 2004, 119–122). Opredeľuje jih predvsem cilindrična oblika trupa in dokaj velika prostornina, medtem ko je profilacija ustja lahko zelo različna, saj po Keayu obsega 29 variant. Nekateri avtorji zato predlagajo bolj poenostavljeno delitev (Bonifay, Piéri 1995, 95; Freed 1995, 181). Bonifay jih je v svoji zadnji študiji uvrstil v tipe 27/*africana* III A, 28/*africana* III B in 29/*africana* III C (Bonifay 2004, 119–122, sl. 63–65). Tip Bonifay 27/*africana* III A ustreza tipom Keay 25: A–C, tip Bonifay 28/*africana* III B tipom Keay 25: K–V in tip Bonifay 29/*africana* III C tipu Keay 25: E–I. Tipi se med seboj ločijo tudi kronološko. Zgodnje variante tipa III A so datirane v konec 3. in na začetek 4. st., tipa III A in B v 4. st., tip III C pa v konec 4. in prvo polovico 5. st. (Bonifay 2004, 122).

Amfore so tunizijskega izvora, v uporabi naj bi bile za prevoz olja (Keay 1984, 193–194; Panella 1993, sl. 2), čeprav glede na posmoljeno notranjost nekateri avtorji domnevajo, da so se uporabljale predvsem za prevoz vina (Bonifay 2004, 122, 474).

Predvsem v 4. st. so predstavljale cilindrične amfore srednjih dimenzij najpogostejšo obliko amfor v večini sredozemskih pristanišč.

Na Tonovcovem gradu v tip Keay 25 G (Keay 1984, sl. 79: 2–3) oziroma *africana* III C (Bonifay 2004, 119) lahko uvrstimo ustja amfor t. 67: 5–6, morda tudi t. 67: 4. Eni od variant tipa Keay 25 lahko pripišemo tudi konico na t. 67: 7.<sup>26</sup>

Tudi na jugovzhodnoalpskem območju sodijo med najpogostejše zastopane afriške amfore. Pojavljajo se v mestih, npr. v Emoni (Vidrih Perko 1994b, Starokrščanski center, predel ob šoli Majde Vrhovnik, t. 5: 3–4,6), pogoste pa so zlasti na najdiščih zahodne Slovenije. Tip 25 G je bil najden na Rodiku (Vidrih Perko 1997a, sl. 2: 23–25), v Biljah (Vidrih Perko 1994b, Bilje, t. 2: 5) in Fizinah pri Portorožu (Gaspari et al. 2007, t. 7: 168). Različne druge variante so znane iz Ajdovščine (Vidrih Perko 1994b, Ajdovščina, t. 7: 1–2; 9: 1), s Hrušice (Vidrih Perko 1992b, t. 3: 2–3), najdene pa so bile tudi v Šmarati (Perko, Bavdek, Lazar 1998, t. 2: 2–4,18–20), na Križni gori (Vidrih Perko 1994b, Križna gora, t. 1: 7–9), Školaricah (Žerjal 2008, t. 43: 1156–1160,1166; 44) in v Predjami (Korošec 1956, t. 19: 2).

<sup>26</sup> Določevanje variant samo po ustju je včasih nezanesljivo, saj so pozne variante (Keay 25 E–I, Bonifay *africana* III C) po obliki ustja lahko zelo podobne zgodnejšim oblikam, bistveno pa se od njih ločijo po obliki vratu, ki je cilindrično podaljšan, prav tako tudi telo.

1984, 184–212). This amphora type was developed from the earlier African forms, i.e. the form *Africana grande* (*Africana* II) and is the forerunner of the large cylindrical amphorae from the late 5<sup>th</sup> and early 6<sup>th</sup> century, which is why Bonifay proposed the name *Africana* III (Bonifay 2004, 119–122). They are defined by their cylindrical body and their relatively large volume, and can have numerous rim variants – 29 according to Keay. Some authors have thus proposed a simplified division (Bonifay, Piéri 1995, 95; Freed 1995, 181). In his last study Bonifay divided them into the following types: 27/*Africana* III A, 28/*Africana* III B and 29/*Africana* III C. Type Bonifay 27/*Africana* III A covers types Keay 25: A–C, type Bonifay 28/*Africana* III B covers types Keay 25: K–V and type Bonifay 29/*Africana* III C covers types Keay 25: E–I. The types also differ chronologically. The early variants of type III A are dated into the end of the 3<sup>rd</sup> and the beginning of the 4<sup>th</sup> century, type III A and B into the 4<sup>th</sup> century, and type III C into the end of the 4<sup>th</sup> and first half of the 5<sup>th</sup> century (Bonifay 2004, 122).

The amphorae are of Tunisian origin, and they were supposedly used to transport oil (Keay 1984, 193–194; Panella 1993, Fig. 2), even though the resin-covered interior leads some authors to assume they were used predominantly to transport wine (Bonifay 2004, 122, 474).

In the 4<sup>th</sup> century mid-sized cylindrical amphorae were the most common type of amphorae in most Mediterranean ports.

On Tonovcov grad the rims of amphorae Pl. 67: 5–6 and maybe also Pl. 67: 4 can be categorised as type Keay 25 G (Keay 1984, Fig. 79: 2–3) or *Africana* III C (Bonifay 2004, 119). One of the variants of type Keay 25 can also be ascribed to the base on Pl. 67: 7.<sup>26</sup>

This type is the most commonly represented African amphora in the Southeastern Alps. They appear in towns, e.g. in Emona (Vidrih Perko 1994b, Starokrščanski center, predel ob šoli Majde Vrhovnik, Pl. 5: 3–4,6), and are especially common in western Slovenia. Type 25 G was discovered "at Rodik (Vidrih Perko 1997a, Fig. 2: 23–25) in Bilje (Vidrih Perko 1994b, Bilje, Pl. 2: 5) and Fazine near Portorož (Gaspari et al. 2007, Pl. 7: 168). Various variants were also discovered in Ajdovščina (Vidrih Perko 1994b, Ajdovščina, Pls. 7: 1–2, 9: 1) and at Hrušica (Vidrih Perko 1992b, Pl. 3: 2–3). They were found also in Šmarata (Perko, Bavdek, Lazar 1998, Pl. 2: 2–4,18–20), at Križna gora (Vidrih Perko 1994b, Križna gora, Pl. 1: 7–9), Školarice (Žerjal 2008, Pls. 43: 1156–1160,1166; 44) and in Predjama (Korošec 1956, Pl. 19: 2).

All examples from Tonovcov grad were found in the Late Antiquity 2 layers or in mixed layers.

<sup>26</sup> Defining variants only with the use of rims can be unreliable, for the late variants (Keay 25 E–I, Bonifay *Africana* III C) have similar rim shapes to the early forms, however they differ greatly by the shape of the neck and body, both of which are cylindrically prolonged.

Primerki s Tonovcovega gradu so bili najdeni v plasteh druge poznoantične faze in v premešanih humusnih plasteh

#### Keay 26 (“*spatheia*”)

Nekaj primerkov amfor lahko pogojno pripišemo tipu Keay 26. Gre za široko skupino velikih tunizijskih cilindričnih amfor s številnimi podtipi, za katere se je v literaturi uveljavilo ime *spatheia*.<sup>27</sup> Tip je oblikovno soroden tipu Keay 25, le da je manjši. Po nekaterih interpretacijah pri tako imenovanem klasičnem spatejonu sploh ne gre za poseben tip, ampak le za manjšo varianto tipa Keay 25/africana III C (Bonifay 2004, 125). V tip 26 so po Keayu uvrščene tako srednje velike cilindrične amfore iz 5. st., kot tudi male amforice – “pozni mali spatejoni” (tipi Keay 26 F, G in H) iz druge polovice 6. in iz 7. st. (Mackensen 1992, 245–252; Bonifay, Piéri 1995, 97), vendar pa je njihova dejanska povezava vprašljiva (Bonifay 2004, 125).

Novejši predlogi to razdelitev spreminjajo. Tako je bila najprej predlagana delitev na klasične spatejone, druge spatejone in pozne male spatejone (Bonifay, Piéri 1995, 97). Bonifay je obdržal razdelitev na tri tipe, ki jih je še razčlenil z variantami. Tako so tako imenovani klasični spatejoni po Bonifayevi delitvi uvrščeni v tip 31 oziroma “*spatheion* 1” ter razdeljeni v variante A–D, datirane v prvo polovico 5. st. V tip 32 oz. “*spatheion* 2” so uvrščene male amfore, ki naj bi bile predhodnice pravih poznih malih spatejonov. Spatejoni 2 so razdeljeni v dve varianti, od katerih je varianta A datirana v drugo polovico 5. st., varianta B pa v 6. st. Pozni mali spatejoni so uvrščeni v tip 33 oz. “*spatheion* 3”, razdeljeni pa so v 4 variante, datirane od konca 6. do druge polovice 7. st. (Bonifay 2004, 125–129, sl. 67–69). “Pozni mali spatejoni” bodo zato v nadaljevanju obravnavani ločeno, tu pa le tako imenovani “klasični spatejoni”.

Tudi vsebina teh amfor ni popolnoma jasna. Prvotno so veljale za vinske amfore (Manacorda 1977, 220). Zaradi najdb oljčnih koščic in ostankov rib v nekaterih amforah je bila postavljena domneva o njihovi raznoliki vsebini (Keay 1984, 215), Bonifay pa domneva, da je prvenstveno vseeno šlo za vinske amfore, ki so bile lahko uporabljene tudi za druge produkte, kot so oljke in ribe (Bonifay 2004, 129, 474).

Med gradivom iz stavbe 1 lahko v skupino Keay 26 pogojno uvrstimo stebričast zatič (t. 67: 8) ter nekaj ostenj.

Te amfore so pogoste predvsem na podeželskih najdiščih zahodne Slovenije. Najdene so bile v Šmarati

<sup>27</sup> Gre za izraz, ki je bil uveden na podlagi napisov na egipčanskih papirusih, novejša raziskava pa dokazujejo, da je bil originalno uporabljan za bikonične egipčanske amfore in ne za afriške, zato naj bi se za afriške uporabljal le pogojno (zbrano pri Bonifay 2004, 125).

#### Keay 26 (*‘spatheia’*)

Some amphorae examples can conditionally be categorised into type Keay 26. This is a broad group of large Tunisian cylindrical amphorae with a number of variants, in literature most commonly known under the name of *spatheia*.<sup>27</sup> The type is similar in shape to type Keay 25, only smaller. According to some interpretations the so-called classical *spatheion* is not a separate type at all, but merely a smaller variant of the Keay 25/Africana III C (Bonifay 2004, 125). According to Keay type 26 includes medium sized cylindrical amphorae from the 5<sup>th</sup> century, as well as small amphorae – ‘late small *spatheia*’ (types Keay 26 F, G and H) that appear in the second half of the 6<sup>th</sup> and in the 7<sup>th</sup> century (Mackensen 1992, 245–252; Bonifay, Piéri 1995, 97); however their actual connection is questionable (Bonifay 2004, 125).

The newer proposals are introducing changes to this division. The first one proposed the division into classic *spatheia*, other *spatheia* and late small *spatheia* (Bonifay, Piéri 1995, 97). Bonifay retained the division in three types, but added additional subtypes. According to Bonifay’s classification the so-called classical *spatheia* are placed into type 31 or ‘*spatheion* 1’ and divided into subtypes A–D, dated into the first half of the 5<sup>th</sup> century. Type 32 or ‘*spatheion* 2’ consisted of small amphorae, which were supposedly the predecessors of the true late small *spatheia*. *Spatheia* 2 were divided into two subgroups, of which subgroup A was produced in the second half of the 5<sup>th</sup> century, and subgroup B in the 6<sup>th</sup> century. The late small *spatheia* form type 33 or ‘*spatheion* 3’, and are divided into four subgroups, dated between the end of the 6<sup>th</sup> and the second half of the 7<sup>th</sup> century (Bonifay 2004, 125–129, Figs. 67–69). ‘Late small *spatheia*’ will be treated separately in the continuation, while at this point we will focus only on the so called ‘classic *spatheia*’.

It is not clear what was transported in these amphorae. Originally they were believed to be used to transport wine (Manacorda 1977, 220). Due to the discovery of olive pits and fish remains in some amphorae it has been recently assumed that they were used for various contents (Keay 1984, 215), however Bonifay assumed that they were primarily used for wine but could also be used for other products, such as olives and fish (Bonifay 2004, 129, 474).

Amongst the material from building 1 the columnar base (Pl. 67: 8) and few undefined wall fragments can be conditionally placed into the group Keay 26.

This form is known mainly in rural sites in western Slovenia. They were found in Šmarata (Perko, Bavdek,

<sup>27</sup> This is a term that was introduced on the basis of the inscriptions found on Egyptian papyri, and newer research has shown that it was originally used for biconical Egyptian amphorae and not African ones, thus it is used only conditionally for African ones (collected at Bonifay 2004, 125).

(Perko, Bavdek, Lazar 1998, t. 2: 29), Štanjelu (Vidrih Perko 1997b, t. 5: 15), na Rodiku (Vidrih Perko 1997a, sl. 2: 26–27), v Mostu na Soči (Vidrih Perko 1994b, Most na Soči, Sv. Lucija, t. 1: 1), na Školaricah (Žerjal 2008, 141, t. 4: 1189–1195) in v Ajdovščini (Vidrih Perko 1994b, Ajdovščina, t. 7: 4; 8: 5; 9: 34). Pogoste so v Akvileji (Donat 1994a, 433–436, t. 67: 23–26) in Trstu (Zulini 2007, 159, t. 34: 80–81; 35: 82).

### Keay 35 A

Amfora t. 68: 1 spada v tip Keay 35 A (Keay 1984, sl. 98: 2,4; 99) oziroma Bonifay 40 (Bonifay 2004, 134–135, sl. 72a: 1).<sup>28</sup> To so amfore z močno odebeljenim ustjem, oranžno do opečno rdeče barve, z vidnimi belimi ali rumenimi vključki, z belorumenim premazom, na katerem so sledi vertikalnih žlebov (Ghalia, Bonifay, Capelli 2005, 496).

Obe varianti oblike Keay 35 (35 A in 35 B) sodita med najpogostejše amfore v zahodnem Sredozemlju v prvi polovici 5. st. (Bonifay, Piéri 1995, 98; Bonifay 2004, 135). Amfore Keay 35 A so bile namenjene za prevoz oljčnega olja (Bonifay 2004, 135, 474).

V Sloveniji so znane iz Predloke (Vidrih Perko 2000, 443), Šmarate (Perko, Bavdek, Lazar 1998, t. 2: 10, 17) in s Školaric (Žerjal 2008, št. 1247–1249).

Obraavnani primer s Tonovcovega gradu je bil najden v plasti prve poznoantične faze (Tonovcov grad. Naselbinski ostanki in interpretacija, sl. 3.3: 11).

### Pozni mali spatejoni

Na Tonovcovem gradu so zastopani tudi tako imenovani pozni mali spatejoni (*‘spatheion 3’* po Bonifay 2004, 125–126), ki so po starih klasifikacijah uvrščeni v tip Keay 26 (variante F, G in H; glej zgoraj). Gre za male, 40–50 cm visoke amforice s premerom ustja 6–9 cm. Glede na fakturo lahko ločimo dve skupini. V prvo sodijo amfore, izdelane iz trde, opečno rdeče žgane gline z belim premazom. Druga skupina obsega amfore iz svetle, rumenkaste ali skoraj bele gline z mehkim premazom.

Najdbe velikega števila malih spatejonov svetle fature, ki so pogosti predvsem na kastelih donavskega limesa in na jugovzhodnoalpskih višinskih naselbinah, so spodbudile domnevo, da gre pri njih lahko tudi za vzhodni, neafriški izvor. Tako je Mackensen definiral

<sup>28</sup> Amfora sicer spominja tudi na eno od oblik *africana grande*, in sicer na tip Keay 5 (Keay 1984, 113–114, sl. 43: 1), ki je znan s katalonskih najdišč že od poznega 2. in v 3. st., glede na najdbe iz Ostije pa kaže, da se je produkcija nadaljevala tudi v 4. in 5. st. (Keay 1984, 115–116). Amfore Keay 5 so znane s severnoitalijanskih najdišč (Akvileja: Donat 1991, 213, t. 36; 1994a, 422–423, t. 65–66; Lucinico: Ventura, Degrassi 2005, sl. 3: 4).

Lazar 1998, Pl. 2: 29), Štanjel (Vidrih Perko 1997b, Pl. 5: 15), at Rodik (Vidrih Perko 1997a, Fig. 2: 26–27), in Most na Soči (Vidrih Perko 1994b, Most na Soči, Sv. Lucija, Pl. 1: 1), at Školarice (Žerjal 2008, 141, Pl. 4: 1189–1195) and in Ajdovščina (Vidrih Perko 1994b, Ajdovščina, Pls. 7: 4; 8: 5; 9: 34). They are common in Aquileia (Donat 1994a, 433–436, Fig. 67: 23–26) and Trieste (Zulini 2007, 159, Pls. 34: 80–81; 35: 82).

### Keay 35A

Amphora Pl. 68: 1 can be categorised as type Keay 35 A (Keay 1984, Figs. 98: 2,4; 99) or Bonifay 40 (Bonifay 2004, 134–135, Fig. 72a: 1).<sup>28</sup> These amphorae are orange to brick red in colour, they have visible white or yellow inclusions, and a white-yellow slip upon which we can find traces of vertical grooves (Ghalia, Bonifay, Capelli 2005, 496).

The two Keay 35 subtypes (35 A and 35 B) were one of the most common amphorae in the Western Mediterranean during the first half of the 5<sup>th</sup> century (Bonifay, Piéri 1995, 98; Bonifay 2004, 135). Amphorae Keay 35 A were used for transporting olive oil (Bonifay 2004, 135, 474).

In Slovenia they were discovered in Predloka (Vidrih Perko 2000, 443), Šmarata (Perko, Bavdek, Lazar 1998, Pl. 2: 10,17) and at Školarice (Žerjal 2008, Nos. 1247–1249).

Amphora Keay 35 from Tonovcov grad was discovered in a Late Antiquity 1 layer (Tonovcov grad. Settlement remains and interpretation, Fig. 3.3: 11).

### Late small spatheia

On Tonovcov grad the so-called late small spatheia (*‘spatheion 3’* according to Bonifay 2004, 125–126) were also discovered. These small, 40–50 cm high amphorae with a rim diameter measuring between 6 and 9 cm were in the early classifications placed into type Keay 26 (subgroups F, G and H; see above). According to their fabric they can be divided into two groups. The first one consists of amphorae made from hard, brick red fired clay with a white slip. The second group covers amphorae from bright, yellowish or almost white clay with a soft slip.

<sup>28</sup> This amphora is reminiscent of one of the *africana grande* forms, i.e. type Keay 5 (Keay 1984, 113–114, Fig. 43: 1), which is known already from the late 2<sup>nd</sup> and 3<sup>rd</sup> century Catalan sites. Taking into account the finds from Ostia it seems that the production continued into the 4<sup>th</sup> and 5<sup>th</sup> century (Keay 1984, 115–116). Amphorae Keay 5 have been discovered in North Italian sites (Aquileia: Donat 1991, 213, Pl. 36; 1994a, 422–423, Pls. 65–66; Lucinico: Ventura, Degrassi 2005, Fig. 3: 4).





Sl. 4.6: Spatejon, najden v prezbitteriju osrednje cerkve( t. 101: 7; foto: M. Zaplatil). Pomanjšano.

Fig. 4.6: Spatheion from the presbytery of the main church (Pl. 101: 7; photo: M. Zaplatil). Diminished.

posebno, vzhodnomeditersko skupino malih vretenastih amfor dolžine 40–50 cm. V to skupino je bila uvrščena tudi večina slovenskih primerkov (Mackensen 1992, 246–251, sl. 3: 1–2; 4: 1–2). Novejše petrografske in kemične analize spatejonov te tako imenovane vzhodnomediterske skupine pa kažejo, da gre tudi pri njih za severnoafriški izvor (Capelli 1998, 331–332; Ladstätter 2003, 842, op. 47; Bonifay 2004, 129). Odkrite so bile tudi delavnice teh amfor pri krajih Nabeul (*Neapolis*) in Moknine na vzhodni tunizijski obali (Bonifay 2004, 129).

Vsebina teh amforic je še vedno predmet diskusij. Mogoče je tudi, da je bila v različnih obdobjih različna. Ker so bili nekateri primerki posmoljeni, naj ne bi vsebovale olja. V nekaterih so bili najdeni tudi oljčne koščice in ribji ostanki. Kljub temu naj bi velika razširjenost amfor potrjevala domnevo, da gre predvsem za vinsko amforo (Bonifay 2004, 129), postavlja pa se tudi teza, da je šlo za dragoceno vsebino, povezano z liturgijo (Sagui 2002, 15).

Na Tonovcovem gradu je bil v stavbi 1 najden del ustja malega spatejona iz oranžno žgane, dokaj raskave

As a large number of small spatheia with a bright fabric have been discovered (that are common especially in the forts along the Danubian limes and on the South-eastern Alpine hilltop settlements), it has been assumed that they could also be of an eastern, non-African origin. Thus Mackensen defined a special, Eastern Mediterranean group of small amphorae measuring between 40 and 50 cm in height. Most Slovene examples were categorised in this group (Mackensen 1992, 246–251, Figs. 3: 1–2; 4: 1–2). However, recent petrographic and chemical analyses of spatheia from the so-called Eastern Mediterranean group show that they are North African in origin (Capelli 1998, 331–332; Ladstätter 2003, 842, note 47; Bonifay 2004, 129). The workshops of these amphorae have also been discovered in Nabeul (*Neapolis*) and Moknine on the eastern Tunisian coast (Bonifay 2004, 129).

Content of these small amphorae is still under discussion. It is possible that it varied through time. Oil is excluded as some interiors were covered in resin. Some of them also contained olive pits and fish remains. As this type was extremely widespread it could be assumed that it was mainly used for wine (Bonifay 2004, 129), or to store valuable contents linked to liturgy (Sagui 2002, 15).

A part of a rim of a small 'spatheion' from orange fired, relatively coarse clay was found in building 1 on Tonovcov grad. It had a light slip and a rim with a diameter measuring 7.5 cm (Pl. 68: 2). According to Bonifay's typology the rim shape is best suited to variant C of spatheion 3, i.e. the type with the half-moon rim that was dated into the second half of the 7<sup>th</sup> century (Bonifay 2004, 127–128, Fig. 69: C).

The base (Pl. 68: 3) most likely belongs to the small spatheion that could not be precisely categorised.

A fully preserved spatheion was discovered in the presbytery of the main church (Fig. 4.6; Pl. 101: 7, see also: Tonovcov grad. Settlement remains and interpretation, chapter 2.5.2). It was made from yellow soft powdery clay, and the soft yellowish slip was preserved in places. The exterior revealed traces of vertical polishing, while the interior horizontal grooves (Fig. 4.6). According to the last Bonifay's typology the rim fits variant A (Bonifay 2004, 127, Fig. 69: A 1–2), which is dated into the end of the 6<sup>th</sup> and beginning of the 7<sup>th</sup> century (Bonifay 2004, 129).

Small spatheia are a relatively common find in Slovenia. Contrary to other types of late amphorae they often appear in the sites in the interior. The examples from Slovenia up to 1994 are collected by T. Knific (1994, 223–224, Pls. 6–7,12). Many of them were discovered in Koper, and the fabric led the author to assume they were of African origin (Cunja 1996, 118–119, Pls. 28; 29: 317–319). They were also found at Vranje (Knific 1994, Pls. 6: 1–9; 7: 1), Korinjski hrib (Ciglencečki 1985, Pl. 5: 66–67), Rifnik (Bolta 1981, Pls. 21: 90; 22: 46; 34: 2; Bausovac 2010, Fig. 3: 7–14), Križna gora (Urleb 1974, Pl. 40: 10,13), in Kranj (Knific 1994, Pl. 7: 9; Vidrih Perko, Sagadin 2004, Fig. 6a: 5), Črnomelj (Mason 1998, Pl.

gline, s svetlim premazom, s premerom ustja 7,5 cm (*t.* 68: 2). Oblika ustja po Bonifayevi tipologiji ustreza varianti C "spatejona" 3, to je varianti s polmesečastim ustjem, ki je datirana v drugo polovico 7. st. (Bonifay 2004, 127–128, sl. 69: C).

Malemu spatejonu ožje nedoločljive variante verjetno pripada tudi dno (*t.* 68: 3).

Še en, v celoti ohranjen mali spatejon je bil najden v prezbitariju osrednje cerkve (*sl.* 4.6; *t.* 101: 7, glej tudi Tonovcov grad. Naselbinski ostanki in interpretacija, pogl. 2.5.2). Izdelan je iz mehke, kredaste gline, rumene barve, z delno ohranjenim mehkim rumenkastim premazom. Na zunanji strani so vidni sledovi navpičnega glajenja, na notranji pa vodoravne kanelure (*sl.* 4.6). Po zadnji Bonifayevi tipologiji po obliki ustja ustreza varianti A (Bonifay 2004, 127, sl. 69: A 1–2), datirani v konec 6. in na začetek 7. st. (Bonifay 2004, 129).

Mali spatejoni so dokaj pogosta najdba na slovenskih najdiščih. Za razliko od ostalih tipov poznih amfor so pogosti tudi v notranjosti. Do leta 1994 znane primerke s slovenskega ozemlja je zbral T. Knific (1994, 223–224, t. 6–7,12). Veliko jih je bilo najdenih v Kopru, kjer avtor na podlagi fakture ravno tako predpostavlja njihov afriški izvor (Cunja 1996, 118–119, t. 28; 29: 317–319). Najdeni so bili še na Vranju (Knific 1994, t. 6: 1–9; 7: 1), Korinjskem hribu (Ciglencečki 1985, t. 5: 66–67), Rifniku (Bolta 1981, t. 21: 90; 22: 46; 34: 2; Bausovac 2010, sl. 3: 7–14), Križni gori (Urleb 1974, t. 40: 10,13), v Kranju (Knific 1994, t. 7: 9; Vidrih Perko, Sagadin 2004, sl. 6a: 5), Črnomlju (Mason 1998, t. 1: 8), Piranu (Vidrih Perko 1994a, 241) in na Ajdnu,<sup>29</sup> torej se pojavljajo tako v višinskih naselbinah kot v mestih. V Furlaniji so pogosti na Invillinu (Mackensen 1987, sl. 43: 5–18), znani so tudi iz Vidma (Villa 1998, sl. 4: 1–5), Marana (Villa 1998, t. 2: 3) in Osoppa (Villa 1998, sl. 3: 3). Veliko jih je bilo najdenih na Sv. Hemi (Ladstätter 2000, t. 21). Glede na Bonifayevo razdelitev prevladujejo primerki, ki po obliki ustja ustrezajo ali se približujejo varianti A,<sup>30</sup> vendar je premer njihovega trupa pri večini ohranjenih med 8 in 10 cm, medtem ko je po Bonifayu širina trupa variante A med 12 in 13 cm (Bonifay 2004, 127). Taki primeri so poznani iz Koprca (Cunja 1996, t. 28: 301–302,305), z Vranja (Knific 1994, t. 6: 2,7; 7: 1–2,6), Korinjskega hriba (Ciglencečki 1985, t. 5: 66,67) in Rifnika (Bolta 1981, t. 21: 90). 12 cm širok trup imajo le primerki iz Črnomlja (Mason 1998, t. 1: 8) in z Rifnika (Bausovac 2010, sl. 3: 8,10). Nekaj primerkov po obliki ustja ustreza ali se približuje tudi varianti D (Vranje: Knific 1994, t. 7; Koper: Cunja 1996, t. 28: 306–308; 29: 320–327; Kranj: Vidrih Perko, Sagadin 2004, sl. 6a: 5; Rifnik: Bausovac 2010, sl. 3: 14). Varianta C s polmesečastim robom ustja je na obrav-

1: 8), Piran (Vidrih Perko 1994a, 241) and at Ajdna,<sup>29</sup> thus they seem to appear in hilltop settlements as well as in towns. In Friuli they were common at Invillino (Mackensen 1987, Fig. 43: 5-18) and were also discovered in Udine (Villa 1998, Fig. 4: 1-5), Marano (Villa 1998, Pl. 2: 3) and Osoppo (Villa 1998, Fig. 3: 3). Larger numbers were found on Hemmaberg (Ladstätter 2000, Pl. 21). According to Bonifay's classification types with rim matched or came close to variant A<sup>30</sup> in its shape predominate, however the diameter of most of the preserved examples ranges between 8 and 10 cm, while according to Bonifay the width of the body in variant A should range between 12 and 13 cm (Bonifay 2004, 127). Such examples were found in Koper (Cunja 1996, Pl. 28: 301-302,305), at Vranje (Knific 1994, Pls. 6: 2,7; 7: 1-2,6), Korinjski hrib (Ciglencečki 1985, Pl. 5: 66-67) and Rifnik (Bolta 1981, Pl. 21: 90). Only the examples from Črnomelj (Mason 1998, Pl. 1: 8) and Rifnik (Bausovac 2010, Fig. 3: 8,10) measured 12 cm in width. In some examples the rim shape matched or came close to variant D (Vranje: Knific 1994, Pl. 7; Koper: Cunja 1996, Pls. 28: 306-308; 29: 320-327; Kranj: Vidrih Perko, Sagadin 2004, Fig. 6a: 5; Rifnik: Bausovac 2010, Fig. 3: 14). Variant C with the semi-circular rim is rare in the discussed area, and was discovered only at Tonovcov grad, Invillino (Mackensen 1987, Fig. 44: 7-8,14) and Hemmaberg (Ladstätter 2000, Pl. 21: 10).

The dating of the late small spatheia is – also due to its various shapes – still a subject of discussion. Mackensen dated them into the 6<sup>th</sup> and first half of the 7<sup>th</sup> century and linked them to the early Byzantine fortifications along the Danube river (Mackensen 1992, 245-251). The new study by Bonifay sets the dates slightly later, for he places the oldest examples (variant A) into the end of the 6<sup>th</sup> and beginning of the 7<sup>th</sup> century, variant B and D into the 7<sup>th</sup> century, and variant C into the second half of the 7<sup>th</sup> century (Bonifay 2004, 129).

The small spatheion with a semi-circular rim (*Pl.* 68: 2; variant C according to Bonifay) was found in the demolition layer of building 1, which belongs to Late Antiquity 2 phase. For the discussion as regards the age the context of the find of the fully preserved spatheion (*Pl.* 101: 7) from the main church is important. It was found in a rock crevice in front of the altar of the main church, together with a Justinian's coin inside. The burial of the amphora is connected to the rebuilding of the church in the mid 6<sup>th</sup> century (see also: Tonovcov grad. Settlement remains and interpretation, chapter 3.3.1); this period is confirmed by the coin, dated between 540 and 552 (see chapter 5.1, No. 157).

The finds discovered on other hilltop settlements in the Southeastern Alps can also be dated into the mid

<sup>29</sup> Neobjavljeno, za podatek se zahvaljujem V. Vidrih Perko.

<sup>30</sup> Obravnavani spatejoni imajo zelo raznolike zaključke ustij, ki vedno ne ustrezajo popolnoma kateri od pri Bonifayu definiranih variant.

<sup>29</sup> Unpublished, I would like to thank V. Vidrih Perko for the information.

<sup>30</sup> The discussed spatheia have very varied rim endings that do not always fit any of the variants defined by Bonifay.

navanem območju redka, poleg Tonovcovega gradu je znana še z Invillina (Mackensen 1987, sl. 44: 7–8,14) in s Sv. Heme (Ladstätter 2000, t. 21: 10).

Datacija poznih malih spatejonov je – tudi zaradi njihove velike raznolikosti – še vedno predmet diskusije. Mackensen jih je datiral v 6. in prvo polovico 7. st. in jih povezal z zgodnjebizantinsko utrditvijo kastelov ob Donavi (Mackensen 1992, 245–251). Nova Bonifayeva študija datacije pomika navzgor, saj postavlja najstarejše primerke (varianta A) v konec 6. in začetek 7. st., varianti B in D v 7. st., medtem ko naj bi bila varianta C značilna za drugo polovico 7. st. (Bonifay 2004, 129).

Mali spatejon s polmesečastim ustjem (*t.* 68: 2; varianta C po Bonifayu) je bil najden v ruševinski plasti stavbe 1, ki pripada drugi poznoantični fazi. Za diskusijo o starosti je pomemben tudi kontekst najdbe celega spatejona (*t.* 101: 7). Najden je bil namreč v skalni razpoki pred oltarjem osrednje cerkve, vanj pa je bil položen Justinijanov novec. Zakop amfore je povezan s pregradnjo cerkve v sredini 6. st. (glej tudi Tonovcov grad. Naselbinski ostanki in interpretacija, pogl. 3.3.1), ta čas pa potrjuje tudi novec, datiran med letoma 540 in 552 (glej pogl. 5.1, št. 157).

Dataciji v sredino oziroma drugo polovico 6. st. ustrezajo tudi najdbe na ostalih višinskih naselbinah jugovzhodnoalpskega prostora. Najstarejši znan primerki je s Sv. Heme, kjer je bil mali spatejon najden v izravnalnih plasteh pod četrto cerkvijo in je glede na stratigrafsko lego datiran v konec 5. oz. na začetek 6. st. (Ladstätter 2000, 167; 2003, 838). Da je bilo težišče pojavljanja malih spatejonov v jugovzhodnoalpskem prostoru v 6. st., kaže tudi pogostost teh amfor na višinskih naselbinah, katerih propad je v glavnem postavljen v konec 6. st. (Knific 1994, 220). Nekoliko drugačna je bila situacija v mestih, kjer se je življenje nadaljevalo vsaj še v 7. st., v Kopru je domnevano do konca bizantinske oblasti v Istri na prehodu iz 8. v 9. st. (Cunja 1996, 130).

Na višinskih naselbinah sicer prevladuje najstarejša varianta A, ki naj bi začenjala konec 6. st. (Bonifay 2004, 129), pojavljata pa se tudi varianti B in D (Knific 1994, sl. 7: 5,7), po Bonifayu značilne za 7. st., pa tudi varianta C iz druge polovice 7. st. (Tonovcov grad, Invillino, Sv. Hema; Bonifay 2004, 129). Glede na tako pozno datacijo spatejonov bi torej vsaj nekatere višinske naselbine morale živeti in se tudi oskrbovati z uvoženim gradivom še v drugi polovici 7. st., kar pa zaenkrat ni podprto z ostalimi najdbami. Kaže torej, da je bilo težišče pojavljanja malih spatejonov v jugovzhodnih Alpah v 6. st.

### Ožje neopredeljene afriške amfore

Nekaj amfor s tipično afriško fakturo tipološko ni mogoče podrobneje opredeliti (*t.* 67: 9–10; 68: 4–6, 69: 1–3).

or second half of the 6<sup>th</sup> century. The oldest known example was discovered on Hemmaberg, where the small spatheion was found in the levelling layers under the 4<sup>th</sup> church and was according to its stratigraphic position dated into the end of the 5<sup>th</sup> or beginning of the 6<sup>th</sup> century (Ladstätter 2000, 167; 2003, 838). The fact that most of the small spatheia in the Southeastern Alps originate from the 6<sup>th</sup> century is also proven by the frequency of these amphorae in hilltop settlements, most of which were no longer inhabited by the end of the 6<sup>th</sup> century (Knific 1994, 220). Somewhat different is the situation in coastal towns, which were inhabited at least into the 7<sup>th</sup> century. In Koper it is assumed that the Byzantine power ended at the transition between the 8<sup>th</sup> and 9<sup>th</sup> century (Cunja 1996, 130).

Variant A, which is the oldest of them all (as its production supposedly started at the end of the 6<sup>th</sup> century; Bonifay 2004, 129) is also the most frequent variant on hilltop settlements, however variants B and D (according to Bonifay characteristic of the 7<sup>th</sup> century) also appear (Knific 1994, Fig. 7: 5,7). Variant C (second half of the 7<sup>th</sup> century; Bonifay 2004, 129) was found at Tonovcov grad, Invillino an Hemmaberg. Taking into account such late dates some hilltop settlements would have to be inhabited and supplied by foreign products as late as the second half of the 7<sup>th</sup> century, which has so far not yet been confirmed by other finds. This indicates that most small spatheia in the Southeastern Alps originate from the 6<sup>th</sup> century.

### Unclassified African amphorae

Some amphorae with characteristic African fabric cannot be typologically classified (*Pls.* 67: 9–10; 68: 4–6; 69: 1–3).

### EASTERN MEDITERRANEAN AMPHORAE

In the second half of the 5<sup>th</sup> and first half of the 6<sup>th</sup> century Eastern Mediterranean amphorae became dominant across the Mediterranean and its hinterland. Earlier literature links the appearance of Eastern Mediterranean forms to the fall of the Roman government in the West in 476 (Keay 1984, 434–434), however newer research indicates that there was a large increase of Eastern Mediterranean imports (especially LRA 1 and LRA 3) already in the early 5<sup>th</sup> century (Reynolds 1995, 116–118). The Vandal conquest of North Africa and their domination of the sea (after 439 AD) combined with the revitalisation of agricultural production in some parts of the East Mediterranean most likely contributed to the 'opening' of the market to eastern products, even though African exports still remain in this period (Reynolds 1995, 117; see also the chapter African amphorae).

## VZHODNOSREDOZEMSKA AMFORE

V drugi polovici 5. in prvi polovici 6. st. so postale vzhodnosredozemske amfore prevladujoče na najdiščih celotnega sredozemskega prostora in v njegovem zaledju. V starejši literaturi so pojav vzhodnosredozemskih oblik povezovali predvsem s propadom rimske oblasti na zahodu po letu 476 (Keay 1984, 434–434), novejši raziskave pa kažejo na velik porast vzhodnomediterranskih importov (predvsem LRA 1 in LRA 3) že v zgodnjem 5. st. (Reynolds 1995, 116–118). K "odprtju" trga za vzhodne produkte je verjetno največ prispevala vandalska osvojitve severne Afrike in prevlada Vandalov na morju po letu 439, pa tudi oživitve agrarne proizvodnje na nekaterih območjih vzhodnega Sredozemlja, čeprav tudi afriški izvoz v tem obdobju ni popolnoma prenehal (Reynolds 1995, 117; glej tudi poglavje Afriške amfore).

Vzhodnomediterranski importi s svojo razprostranjenostjo po vsem Sredozemlju in v notranosti dokazujejo, da je Sredozemlje v času po letu 476 še vedno funkcioniralo kot enoten trg, ki je oskrboval province z najpomembnejšimi dobrinami. Nekateri avtorji domnevajo, da je bilo kroženje določenih artiklov celo stimulirano s pojemanjem nekaterih davkov, npr. anone (Arthur 1998, 157–158). Proti koncu 6. st. pa je na najdiščih že mogoče opaziti jasen upad večine uvoženih dobrin (Reynolds 1995, 119–120; Arthur 1998, 157–159).<sup>31</sup>

Tipološki okvir vzhodnomediterranskih amfor je s postavitvijo tipov "Late Roman Amphorae 1–7" (LRA) postavil Riley (1976; 1981), v zadnjem obdobju pa razdelal Pieri (2005).

Delavnice vzhodnomediterranskih amfor so bile razširjene po širokem prostoru od egejskih otokov preko maloazijske obale, Sirije in Palestine do Egipta, odkrite so bile tudi na Cipru (Empereur, Picon 1989, 236–247; Panella 1993, 654–673).

Na ozemlju današnje Slovenije so v 4. st. in prvi polovici 5. st. prevladovali afriški importi, od vzhodnosredozemskih zasledimo le obliki LRA 3 in starejše oblike LRA 4. V drugi polovici 5. st. so se vzhodnosredozemske amfore začele pojavljati bolj množično in so skoraj povsem prevladale v 6. st.

Na Tonovcovem gradu lahko razpoznamo večino osnovnih tipov vzhodnomediterranskih amfor. Največ jih je bilo najdenih na območju izkopnega polja stavbe 1, nekaj pa tudi na območju cerkvenega sklopa in v stavbah 2 in 3.

Delež vzhodnosredozemskih amfor med amforami s Tonovcovega gradu obsega 33 % glede na število vseh najdenih amfor oziroma 27 % glede na njihovo težo (sl. 4.4, 4.5).

<sup>31</sup> Prvi kolaps sistema naj bi bil nepričakovana posledica Justinijanove politike (Arthur 1998, 157), saj naj bi imela ponovna uvedba anone po osvojitvi severnoafriških provinc katastrofalne posledice za severnoafriško kmetijsko pridelavo (Keay 1984, 427).

The spread of Eastern Mediterranean imports across the entire Mediterranean and into the interior indicates that the Mediterranean functioned as a unified market that supplied the provinces with the most important goods even after 476 AD. Some authors assumed that the circulation of certain articles was stimulated by lowering certain taxes, e.g. annona (Arthur 1998, 157–158). Towards the end of the 6<sup>th</sup> century the sites showed a clear decline in imports of most imported goods (Reynolds 1995, 119–120; Arthur 1998, 157–159).<sup>31</sup>

With the introduction of the 'Late Roman Amphorae 1–7' (LRA) the typological frame of the Eastern Mediterranean amphorae was set by Riley (1976; 1981) and recently expanded by Pieri (2005).

Workshops producing Eastern Mediterranean amphorae spread from the Aegean islands, across the coast of Asia Minor, Syria and Palestine to Egypt, and were also discovered on Cyprus (Empereur, Picon 1989, 236–247; Panella 1993, 654–673).

In the present day Slovenia African imports dominated throughout the 4<sup>th</sup> and first half of the 5<sup>th</sup> century, and only forms LRA 3 and the older LRA 4 were found of the Eastern Mediterranean pottery. In the second half of the 5<sup>th</sup> century Eastern Mediterranean amphorae started appearing in greater numbers and in the 6<sup>th</sup> century they were almost totally dominant.

Most of the basic types of Eastern Mediterranean amphorae were found at Tonovcov grad. Most of them were found in the excavation area of building 1, while a few were found in the area of the ecclesiastical complex and in buildings 2 and 3.

At Tonovcov grad Eastern Mediterranean amphorae represented 33 % (taking into account the number of all discovered amphorae) or 27 % (taking into account the weight of the discovered amphorae) of all discovered amphorae (Figs. 4.4, 4.5).

## LRA 1

LRA 1 is represented with several examples. This is a bag-shaped amphora, with a narrow, conical neck and a slightly everted rim. The neck is linked to the shoulder with a grooved handle. The body is ribbed with wide and narrow ribs. The base is almost flat or slightly button-like. This is most likely the most common Late Roman amphora of eastern origin (Arthur 1998, 164). It spread across the entire Mediterranean and was commonly found in the interior (Gaul: Pieri 2005, 70–85; Danubian area: Opař 2004a, 96–98; Karagiorgou 2001,

<sup>31</sup> The first collapse of the system is an unexpected consequence of Justinian's policy (Arthur 1998, 157), as the re-introduction of the annona that followed the conquest of the North African provinces had catastrophic consequences for the North African agricultural production (Keay 1984, 427).

## LRA 1

Z več primerki je zastopan tip LRA 1. To je amfora vrečaste oblike, z ozkim, koničnim vratom in rahlo izvihanim ustjem. Vrat povezuje z ramenom kaneliran ročaj. Trup je narebren s širšimi in ožjimi rebri, dno je skoraj ravno ali rahlo gumbasto odebeljeno. To je verjetno najpogostejša poznorimska amfora vzhodnega izvora (Arthur 1998, 164). Razširjena je bila po vsem sredozemskem prostoru in pogosta tudi v notranjosti (Galija: Pieri 2005, 70–85; Podonavje: Opař 2004a, 96–98; Karagiorgou 2001, 129–166), posamezni primerki so bili najdeni tudi na Britanskem otočju (Arthur 1998, 164).

Izvorno območje amfor LRA 1 je bilo glede na veliko koncentracijo odkritih delavnic verjetno na južni obali Turčije in v severni Siriji, pa tudi na Rodosu in Cipru (Empereur, Picon 1989, 236–243, sl. 18; Pieri 2005, 80, sl. 38; Williams 2005a, 160–161; Reynolds 2005, 565–567; Burrigato et al. 2007, 689–700; Opař 2010, 1015–1022).

Amfora je tipološko zelo raznolika, zadnji razdelitvi predlagata Opař (2004b, 8–10) in Pieri (2005, 70–85).

Kronološko naj bi predhodniki tega tipa segali še v konec 3. st., zgodnja varianta je nekoliko manjša od klasične in je datirana v 4. st (Arthur 1998, 164; Pieri 2005, 70; Opař 2010, 1015–1017). Klasičen tip LRA 1 se pojavlja v kontekstih druge polovice 5. in v 6. st. (Arthur 1998, 164), pozne variante tudi še do sredine 7. st. (Arthur 1998, 165; Pieri 2005, 85).

O vsebini teh amfor se mnenja razlikujejo (pregledno pri Pieri 2005, 81–85). Na podlagi ostankov grozdnih pešk in rozin v amforah iz brodoloma Yassi Ada je bila postavljena domneva, da so vsebovale vino in izdelke na osnovi vina (Van Alfen 1996, 203). Tudi Pieri na podlagi mnogih primerkov s posmoljeno notranjostjo meni, da je šlo prvenstveno za vinske amfore (Pieri 2005, 81–85). Izvorno območje teh amfor tudi pisni viri namreč omenjajo kot območje pridelave kakovostnega vina (zbrano pri Pieri 2005, 84–85).

Ker gre za dolgotrajno obliko, ki je doživela tudi precejšen tipološki razvoj, je mogoče, da se je vsebina spreminjala skozi čas (Arthur 1998, 164–165; Reynolds 1995, 71; 2005; Williams 2005b, 617; Opař 2004b, 104; Elton 2005, 692).

Razmah teh amfor v 5. st. povezujejo tudi z vojaško anono. Njihova tipološka raznovrstnost in velika pogostost sicer izključujeta zgolj vojaško rabo, mogoča pa je občasna stimulacija proizvodnje v povezavi z anono (Reynolds 2005, 577; Elton 2005, 693–694).<sup>32</sup>

Zaradi pogostih znakov in napisov s krščansko motiviko na njih (Pieri 2005, 78–79) nekateri avtorji domnevajo, da so vsebovale vino za evharistijo (Laubenheimer 1990).

<sup>32</sup> Povezava z vojaško anono se predvideva npr. za pozno ciprsko proizvodnjo v 6. in prvi polovici 7. st., ko je bil Ciper z Justinijanovo reorganizacijo anone vključen v mrežo oskrbet čet na spodnji Donavi (Reynolds 2005, 576; Elton 2005, 693).

129–166), with individual examples found as far as the British Isles (Arthur 1998, 164).

Due to the vast concentration of discovered workshops the origin of LRA 1 amphorae is suggested on the south Turkish coast and in northern Syria, as well as on Rhodes and Cyprus (Empereur, Picon 1989, 236–243, Fig. 18; Pieri 2005, 80, Fig. 38; Williams 2005a, 160–161; Reynolds 2005, 565–567; Burrigato et al. 2007, 689–700; Opař 2010, 1015–1022).

The amphorae were typologically diverse, and the last classification was proposed by Opař (2004b, 8–10) and Pieri (2005, 70–85).

Chronologically the precursors of this type reached into the end of the 3<sup>rd</sup> century; however the early variant can be dated into the 4<sup>th</sup> century and was slightly smaller than the classical form (Arthur 1998, 164; Pieri 2005, 70; Opař 2010, 1015–1017). The classical LRA 1 appears in contexts belonging to the second half of the 5<sup>th</sup> and the 6<sup>th</sup> century (Arthur 1998, 164), while late variants continued until the mid 7<sup>th</sup> century (Arthur 1998, 165; Pieri 2005, 85).

There are different opinions as to the content of these amphorae (overview at Pieri 2005, 81–85). Based on the remains of grape pips and raisins found in the amphorae from the Yassi Ada shipwreck it was assumed that they carried wine and wine-based products (Van Alfen 1996, 203). The numerous examples with an interior coated with resin led Pieri to believe they were primarily used to transport wine (Pieri 2005, 81–85). Literary sources also mention that the area of origin of these amphorae produced quality wine (gathered at Pieri 2005, 84–85).

As this shape remained in use over a longer period, through which it saw numerous typological changes, it is possible that its use changed through time (Arthur 1998, 164–165; Reynolds 1995, 71; 2005; Williams 2005b, 617; Opař 2004b, 104; Elton 2005, 692).

The spread of this amphora type in the 5<sup>th</sup> century is also linked to the military annona. Their typological diversity and frequency excludes merely military use, however it is possible that the production was occasionally stimulated in relation to the annona (Reynolds 2005, 577; Elton 2005, 693–694).<sup>32</sup>

Due to the frequent Christian signs and inscriptions (Pieri 2005, 78–79) some authors assume that they were used for the wine used for the Eucharist (Laubenheimer 1990).

At Tonovcov grad the preserved rim linked to the shoulder with a grooved handle (*Pl.* 69: 4) can be categorised as LRA 1. The amphora belongs to the classical variant of the LRA 1 or type LRA 1B (Pieri 2005,

<sup>32</sup> The connection to the military annona is assumed for instance for the late Cyprian production in the 6<sup>th</sup> and first half of the 7<sup>th</sup> century, when Cyprus was included into the annona with Justinian's reorganisation of the troop supply network along the lower Danube (Reynolds 2005, 576; Elton 2005, 693).

Tipu LRA 1 na Tonovcovem gradu pripisujemo v celoti ohranjeno ustje, ki ga z ramenom povezuje kaneliran ročaj (*t.* 69: 4). Amfora pripada klasični varianti tipa LRA 1 oziroma tipu LRA 1B (Pieri 2005, 75–76). Ta oblika se pojavi v drugi polovici 5. st. in je v uporabi celo 6. st. ter tudi še na začetku 7. st. (Reynolds 1995, 7; Pieri 2005, 75–76).

Amfora je bila najdena v stavbi 1, v plasti druge poznoantične faze.

LRA 1 je tudi na slovenskih najdiščih dokaj pogosta amfora. V glavnem se pojavlja na višinskih naseljih. Amfore tega tipa so bile najdene na Gradišču nad Bašljem (Vidrih Perko 1994b, Bašelj, t. 1: 1–2), Sv. Pavlu nad Vrtovinom (Svoljšak 1985, t. 7: 118–120), Križni gori (Vidrih Perko 1994b, Križna gora, t. 1: 3–6), Rifniku (Bausovac 2010, sl. 3: 1–5). Poznane so tudi iz jamskih najdišč, tako npr. iz Predjame (Vidrih Perko 1994b, Predjama, t. 1: 1), Acijevega spodmola (Turk et al. 1992, t. 6: 14a,b,c) in Podmola (Turk et al. 1993, t. 18: 22). Pogoste so na obalnih najdiščih, v Piranu (Vidrih Perko 1994a, sl. 2: 1–4), Koprju (Vidrih Perko 1994b, Koper, Kidričeva ulica, t. 1: 9; Koper, Trg Giordana Bruna in ulica Garibaldi, t. 7: 4) in Fizinah pri Portorožu (Gaspari et al. 2007, t. 7: 172). Od naselij v notranjosti so bile najdene v Črnomlju (Vidrih Perko 1994b, Črnomelj, t. 1: 1,6,8–9; Mason 1998, t. 2: 1) in Mengšu (Sagadin 1995, t. 2: 11).

Pogoste so tudi v Furlaniji. Najdene so bile v Vidmu (Villa 1998, 284–285, sl. 4: 13–14), Juliju Karniku (*Iulium Carnicum*; Villa 2002, sl. 8: 1), Attimisu (Villa 2003, t. 1: 2), Gradežu (Malaguti et al. 2007, t. 1: 7), Trstu – Crosada (Auriemma 2007, t. 3471–3472), niso pa poznane z Invillina (Mackensen 1987, 251–252).

S Sv. Heme je objavljen samo en odlomek amfore tega tipa, datiran v pozno 5. in 6. st. (Ladstätter 2000, 165–166, t. 21: 1).<sup>33</sup>

## LRA 2

Z nekaj primerki so na Tonovcovem gradu zastopane tudi amfore tipa LRA 2 (*t.* 69: 5; 70: 1–4). To je amfora s kroglastim trupom, lijakastim ustjem in gumbastim zaključkom. Rame in del trupa sta gosto narebrena z glavničastim orodjem, včasih (predvsem po ramenu) v obliki valovnice (Keay 1984, 352–357, sl. 166; Pieri 2005, 85).

Izvorno območje teh amfor je egejsko-črnomorski prostor, kar potrjujejo tako najdbe delavnic kot tudi velika koncentracija najdenih amfor (Arthur 1998, 168–169; Opař 2004a, 295–296; Pieri 2005, 85–94). Tip je bil široko razprostranjen po vsem sredozemskem prostoru, prevladoval pa je v njegovem vzhodnem delu.

<sup>33</sup> Na območju vzhodnega cerkvenega kompleksa v hiši D (neobjavljeno) je bila najdena velika količina amfor različnih tipov, med njimi tudi LRA 1 (Ladstätter 2000, 164–165, op. 1045).

75–76). This form appeared in the second half of the 5<sup>th</sup> century and remained in use throughout the 6<sup>th</sup> and the beginning of the 7<sup>th</sup> century (Reynolds 1995, 7; Pieri 2005, 75–76).

The amphora was found in building 1, in a Late Antiquity 2 layer.

LRA 1 was relatively common also in Slovenia. Most of the examples were found in hilltop settlements. Amphorae LRA 1 were discovered at Gradišče above Bašelj (Vidrih Perko 1994b, Bašelj, Pl. 1: 1-2), Sv. Pavel above Vrtovin (Svoljšak 1985, Pl. 7: 118-120), Križna gora (Vidrih Perko 1994b, Križna gora, Pl. 1: 3-6), Rifnik (Bausovac 2010, Fig. 3: 1-5). They were discovered also in cave sites, e. g. Predjama (Vidrih Perko 1994b, Predjama, Pl. 1: 1), Acijev spodmol (Turk et al. 1992, Pl. 6: 14a,b,c) and Podmol (Turk et al. 1993, Pl. 18: 22). They were frequently found in coastal sites, in Piran (Vidrih Perko 1994a, Fig. 2: 1-4), Koper (Vidrih Perko 1994b, Koper, Kidričeva ulica, Pl. 1: 9; Koper, Trg Giordana Bruna in ulica Garibaldi, Pl. 7: 4) and Fazine near Portorož (Gaspari et al. 2007, Pl. 7: 172). In the inland they were discovered in Črnomelj (Vidrih Perko 1994b, Črnomelj, Pl. 1: 1, 6,8-9; Mason 1998, Pl. 2: 1) and Mengeš (Sagadin 1995, Pl. 2: 11).

They are also common in Friuli. They were found in Udine (Villa 1998, 284-285, Fig. 4: 13-14), Iulium Carnicum (Villa 2002, Fig. 8: 1), Attimis (Villa 2003, Pl. 1: 2), Grado (Malaguti et al. 2007, Pl. 1: 7), Trieste – Crosada (Auriemma 2007, Pl. 3471-3472), however they are not known from Invillino (Mackensen 1987, 251-252).

A single fragment of an amphora of this type (dated into the late 5<sup>th</sup> or 6<sup>th</sup> century) was published from Hemmaberg (Ladstätter 2000, 165-166, Pl. 21: 1).<sup>33</sup>

## LRA 2

A few examples of LRA 2 amphorae (*Pls.* 69: 5; 70: 1-4) were found at Tonovcov grad. This is an amphora with a globular body, a funnel-shaped rim and a button like base. The shoulder and a part of the body were densely ribbed by a comb-like tool, sometimes (especially on the shoulder) in the form of a wavy line (Keay 1984, 352-357, Fig. 166; Pieri 2005, 85).

These amphorae originate from the Aegean – Black sea area, which was confirmed by the discovery of workshops, as well as the large concentration of discovered amphorae (Arthur 1998, 168-169; Opař 2004a, 295-296; Pieri 2005, 85-94). This type is widely spread across the Mediterranean, and especially dominant in the east. These amphorae were especially common in the Danubian area, where they were supposedly linked to the

<sup>33</sup> Large numbers of amphorae were found in house D in the area of the east ecclesiastical complex (unpublished). These amphorae belonged to various types, including LRA 1 (Ladstätter 2000, 164-165, note 1045).

Te amfore so bile posebej pogoste v Podonavju, kjer naj bi bile povezane z organizirano vojaško oskrbo čet na utrdbah podonavskega limesa (Karagiorgou 2001, 149; Opaït 2004a, 307; Swan 2004, 381–382). V zahodnem Sredozemlju naj bi bila njihova prisotnost znak trgovskih povezav (Karagiorgou 2001, 149–151; Pieri 2005, 143–177).

O njihovi vsebini so mnenja nasprotujoča, še najverjetneje je, da so bile večnamenske (zbrano pri Pieri 2005, 92–93).

Amfore LRA 2 imajo dolg razvoj, saj sega pojav zgodnejše variante v pozno 4. st., vrhunec njihove priljubljenosti pa lahko postavimo v prvo polovico 6. st. (Fulford, Peacock 1984, 119–120; Artur 1998, 168–169, Pieri 2005, 86). Proti koncu 6. st. proizvodnja klasičnega tipa LRA 2 preneha, nadaljuje pa se njen razvoj v pozne bizantinske oblike (Artur 1998, 169).<sup>34</sup>

Na Tonovcovem gradu je bila v stavbi 1 najdena ena amfora tipa LRA 2, pri kateri sta ohranjena ustje in precej trebušnega dela (*t.* 69: 5). Poleg tega sta bili najdeni še dve ustji (*t.* 70: 1–2), dva gumbasta zaključka (*t.* 70: 3–4) in nekaj narebrenih ostenj (*t.* 72: 1–7), ki jih lahko pripišemo temu tipu.

V ruševinski plasti stavbe 2 je bil najdeno še zelo slabo ohranjeno ustje (*t.* 100: 6), ki verjetno tudi pripada eni od variant LRA 2.

Vse amfore LRA 2 s Tonovcovega gradu so bile najdene v plasteh druge poznoantične faze ali v premešanih ruševinskih plasteh, v dveh primerih (*t.* 69: 5; 100: 6) skoraj na površini ruševine stavb. To postavlja njihovo datacijo v drugo polovico oziroma konec 6. st.

V Sloveniji so amfore tipa LRA 2 pogoste predvsem na obali in širšem zaledju. Najdene so bile v Koprju (Cunja 1996, 113–114, *t.* 26: 294–296; Kajfež, Josipovič 2000, *t.* 1: 5–6; 3: 1,3; 6: 1–3), Piranu (Snoj, Novšak 1992, 267, *t.* 4: 4–5; Vidrih Perko 1994a, *t.* 4: 1), Fizinah (Gaspari et al. 2007, *t.* 10: 263; 11: 280–283), na Sv. Pavlu nad Vrtovinom (Svoljšak 1985, 208, *t.* 3: 46–48) in Križni gori (Urleb 1974, *t.* 41: 1–2). V notranjosti se pojavljajo redkeje, npr. na Gradišču nad Bašljem (Vidrih Perko 1994b, Bašelj, *t.* 2: 1), v Črnomlju (Mason 1998, *t.* 2: 2), na Rifniku (Bausovac 2010, *sl.* 3: 6), v Kranju (Sagadin 1998, *t.* 1: 5) in Mengšu (Sagadin 1995, *t.* 4: 5).

<sup>34</sup> Mackensen za primerke s Sadovca (Golemanovo Kale) navaja terminus post quem non pribl. 580 (Mackensen 1992, 242). Še naprej v 7. st. pa ostanejo v uporabi ostali tipi kroglastih amfor, npr. amfore iz brodoloma Yassi Ada, ki pa jih po mnenju večine avtorjev ne smemo zamenjevati z LRA 2. Pieri v razvoju amfor LRA 2 predvideva tri variante, od katerih je LRA 2A značilna za 5. st., LRA 2B za 6. st., LRA 2C pa naj bi se pojavila konec 6. in trajala še v 7. st. Naslednice teh tipov – kroglaste amfore – so v Sredozemlju prisotne še do 9. st. (Pieri 2005, 89, op. 121, z zbrano literaturo), vendar jih niso več izdelovali samo na vzhodu, marveč tudi v Afriki (Bonifay 2004, 151–152; Pieri 2005, 89–90), v južni Italiji in Španiji (Pieri 2005, 89, op. 121).

organised military supply of the troops in the forts on the Danubian limes (Karagiorgou 2001, 149; Opaït 2004a, 307; Swan 2004, 381–382). In the West Mediterranean they appear as a sign of trade connections (Karagiorgou 2001, 149–151; Pieri 2005, 143–177).

The opinions as regards their content remain divided however it is highly probable that they were used for different purposes (collected at Pieri 2005, 92–93).

Amphorae type LRA 2 developed over a long period, for the earlier variant appeared in the late 4<sup>th</sup> century and reached the height of its popularity during the first half of the 6<sup>th</sup> century (Fulford, Peacock 1984, 119–120; Artur 1998, 168–169, Pieri 2005, 86). Towards the end of the 6<sup>th</sup> century the production of classical LRA 2 comes to an end, however its development into the late Byzantine forms continues (Arthur 1998, 169).<sup>34</sup>

At Tonovcov grad one LRA 2 amphora was found in building 1. Most of the body and a part of the rim were preserved (*Pl.* 69: 5). Two rims (*Pl.* 70: 1–2), two button-like bases (*Pl.* 70: 3–4) and a few ribbed walls (*Pl.* 72: 1–7), all of which can be categorised into this type, were also found.

A poorly preserved rim (*Pl.* 100: 6) that most likely belongs to one of the LRA 2 variants was discovered in the destruction layer of building 2.

All LRA 2 amphorae from Tonovcov grad were found in Late Antiquity 2 layers or in the mixed destruction layers, two of them (*Pls.* 69: 5; 100: 6) were found almost on top of the building ruins. This places them into the second half and the end of 6<sup>th</sup> century.

In Slovenia LRA 2 amphorae were common especially on the coast and in the broader hinterland. They were discovered in Koper (Cunja 1996, 113–114, *Pl.* 26: 294–296; Kajfež, Josipovič 2000, *Pls.* 1: 5–6; 3: 1,3; 6: 1–3), Piran (Snoj, Novšak 1992, 267, *Pl.* 4: 4–5; Vidrih Perko 1994a, *Pl.* 4: 1), Fizine near Portorož (Gaspari et al. 2007, *Pls.* 10: 263; 11: 280–283), at Sv. Pavel above Vrtovin (Svoljšak 1985, 208, *Pl.* 3: 46–48) and Križna gora (Urleb 1974, *Pl.* 41: 1–2). In the inland they are rare, for example at Gradišče above Bašelj (Vidrih Perko 1994b, Bašelj, *Pl.* 2: 1), in Črnomelj (Mason 1998, *Pl.* 2: 2), at

<sup>34</sup> Mackensen states that the terminus post quem non is approx. 580 AD for the examples from Sadovec (Golemanovo Kale; Mackensen 1992, 242). The other globular amphorae remain in use into the 7<sup>th</sup> century, e.g. the amphorae from the Yassi Ada shipwreck, which should not be confused with LRA 2. In the development of amphorae LRA 2 Pieri assumes three variants, out of which LRA 2A is typical for the 5<sup>th</sup> century, LRA 2B for the 6<sup>th</sup> century, while LRA 2C supposedly appeared at the end of the 6<sup>th</sup> century and continued into the 7<sup>th</sup> century. The descendants of these types – globular amphorae – are present in the Mediterranean into the 9<sup>th</sup> century (Pieri 2005, 89, note 121, with the collected literature), which was no longer produced merely in the east, but also in Africa (Bonifay 2004, 151–152; Pieri 2005, 89–90), south Italy and Spain (Pieri 2005, 89, note 121).

Na območju Furlanije so pogoste na Invillinu (Mackensen 1987, sl. 41: 8; 42: 1–15; t. 95: 8–9; 98: 1), najdene so bile še v Vidmu (Villa 1998, sl. 4: 7–9), Attimisu (Villa 2003, t. 1: 2), Osoppu (Villa 1998, 282, sl. 3: 14–15) in Gradežu (Malaguti et al. 2007, sl. 11, t. 1: 10), dokaj redke pa so v obalnih mestih Akvileji in Trstu (Auriemma, Quiri 2007, 40–41).

En objavljen odlomek s Sv. Heme je datiran na podlagi lege v pozno 5. oz. na začetek 6. st. (Ladstätter 2000, t. 21: 2).

### LRA 3

Nekaj odlomkov ostenj in ročajev amfor lahko na podlagi značilne sljudnate fature pogojno opredelimo kot tip LRA 3, čeprav nobena od amfor ni ohranjena v tolikšni meri, da bi bila opredelitev zanesljiva (t. 72: 3; 73: 6,8–16; 100: 10).

LRA 3 so manjše amfore (prostornina okr. 7 l), z vretenastim trupom, votlo nogo in plitko narebreno površino. Starejša (MRA 3) oblika ima en ročaj, mlajša (LRA 3) pa dva (Riley 1979, 183–186; Pieri 2005, 94). Zaradi značilne rjave, sljudnate fature jih imenujejo tudi sljudnati vrči (*contentiori micacei*, *micaceus jars*, prim. Villa 1994, 405–406). Sam razvoj tega tipa je dolg; zgodnejše oblike segajo še v 2. st., klasična oblika pa je v uporabi od 4. do konca 6. st.<sup>35</sup>

Njihovo izvorno območje je po današnjih raziskavah v Mali Aziji. Predlagani sta dve ožji lokaciji, in sicer v pokrajini Sardi v dolini Hermosa in Meandra ter v okolici Efeza (Panella 1993, 663, op. 213; Pieri 2005, 100). Glede na majhno prostornino so bile verjetno uporabljane za vino (Pieri 2005, 101).

Na Tonovcovem gradu jih je bila večina najdena v izkopnem polju stavbe 1, kjer se pojavljajo že v plasteh prve poznoantične faze, najdene pa so bile tudi še v plasteh druge poznoantične faze. Dva odlomka ene amfore iz stavbe 3 sodita v drugo poznoantično fazo.

Pri nas se v mestih in na podeželskih najdiščih pojavljajo enoročajne (MRA 3) in dvoročajne (LRA 3) oblike, čeprav je pri fragmentarni ohranjenosti ločitev včasih težka (Vidrih Perko 2000, 439). Poznane so iz Emone (Vidrih Perko 1994b, Emona, Starokrščanski center, 75–76, t. 6: 3), Pirana (Vidrih Perko 1994a, sl. 3: 14), z Rodika (Vidrih Perko 1997a, sl. 2: 38–39), iz

Rifnik (Bausovac 2010, Fig. 3: 6), in Kranj (Sagadin 1998, Pl. 1: 5) and Mengeš (Sagadin 1995, Pl. 4: 5).

In the area of Friuli they were common in Invillino (Mackensen 1987, Figs. 41: 8; 42: 1–15; Pls. 95: 8–9; 98: 1), and they were also found in Udine (Villa 1998, Fig. 4: 7–9), Attimis – San Giorgio (Villa 2003, Pl. 1: 2), Osoppo (Villa 1998, 282, Fig. 3: 14–15) and Grado (Malaguti et al. 2007, Fig. 11, Pl. 1: 10), while they were relatively rare in the coastal towns of Aquileia and Trieste (Auriemma, Quiri 2007, 40–41).

The single published fragment from Hemmaberg was dated on the basis of its location into the late 5<sup>th</sup> or early 6<sup>th</sup> century (Ladstätter 2000, Pl. 21: 2).

### LRA 3

On the basis of their characteristic mica fabric a few wall and handle fragments can be conditionally defined as type LRA 3, even though none of the amphorae were preserved to such an extent that this classification would be reliable (Pls. 72: 3; 73: 6,8–16; 100: 10).

LRA 3 were small amphorae (with a volume of approximately 7 l), with a spindle-shaped body, a hollow leg and a shallow-ribbed surface. The older form (MRA 3) had a single handle, while the later (LRA 3) had two (Riley 1979, 183–186; Pieri 2005, 94). Because of the characteristic brown colour and the mica fabric they are also called micaceus jars (*contentiori micacei*, cf. Villa 1994, 405–406). This type developed over a long period and the earlier forms reach as far back as the 2<sup>nd</sup> century, while the classical form was in use between the 4<sup>th</sup> and the end of the 6<sup>th</sup> century.<sup>35</sup>

According to current research they originate from Asia Minor. Two locations were proposed: in the province of Sardi in the Hermos and Meander valley (Panella 1993, 663, note 213; Pieri 2005, 100) and in the vicinity of Efes. Due to their small volume they were most likely used for wine (Pieri 2005, 101).

At Tonovcov grad most of them were discovered in the excavation area of building 1, where they appear already in the Late Antiquity 1 layers, however they were also found in Late Antiquity 2 layers. The two fragments from a single amphora discovered in building 3 can be dated into Late Antiquity 2 phase.

<sup>35</sup> Najzgodnejši egejski importi (npr. vinske amfore z Rodosa) na severnojadranskem prostoru segajo že v 2. st. pr. Kr., kot kažejo npr. nekatere najdbe iz Akvileje (Mandrizzato, Tiussi, Degrassi 2000, 359). Poleg vrčev oz. amfor se na jadranskem prostoru že od začetka 2. st. dalje pojavljajo tudi druge oblike posodja, ki izvira iz vzhodnega Sredozemlja, npr. kozice in pokrovi (Istenič, Schneider 2000, 341). V začetku 3. st. se tudi na jadranskem prostoru pojavijo enoročajni vrči MR3 (Riley 1979, 183), ki se potem v 4. st. razvijejo v dvoročajne (Mandrizzato, Tiussi, Degrassi 2000, 363).

<sup>35</sup> In the North Adriatic the earliest Aegean imports (e.g. wine amphorae from Rhodes) reached back into the 2<sup>nd</sup> century BC, as clearly shown by some finds in Aquileia (Mandrizzato, Tiussi, Degrassi 2000, 359). Apart from jugs and amphorae other East Mediterranean pottery (e.g. pans and lids) also appeared in the Adriatic already at the beginning of the 2<sup>nd</sup> century (Istenič, Schneider 2000, 341). In the beginning of the 3<sup>rd</sup> century single-handle jugs MR3 also appear (Riley 1979, 183), and these develop into two-handled ones in the 4<sup>th</sup> century (Mandrizzato, Tiussi, Degrassi 2000, 363).



Štanjela (Vidrih Perko 1997b, sl. 3: 12; 5: 18), Ajdovščine (Vidrih Perko 1994b, Ajdovščina, t. 6: 5–6; Vidrih Perko, Žbona Trkman 2004, sl. 9: 9,12), s Hrušice (Vidrih Perko 1992b, 349), Školaric (Žerjal 2008, t. 50: 1421–1423) in iz Črnomlja (Mason 1998, t. 2: 3).

Zelo pogoste so v Akvileji (Donat 1994b, 405–407, t. 63: AO12–17), v Furlaniji so znane tudi z višinskih naselij, kot so Invillino (Bierbrauer 1987, sl. 41: 6), Videm (Buora 1990, 52–53) in Osoppo (Donat 1994b, 405).

#### LRA 4

Amfore LRA 4 (amfore Gaza) so razpoznavne po značilni vrečasti obliki, imajo zaokrožen zaključek in so brez pravega vratu. Ustje je kroglasto ali rahlo trikotno odebeljeno. Trup je gosto nažlebljen. Ročaj je majhen, kroglast in postavljen na rame.

Središče proizvodnje je bilo v Gazi in Askalonu, v njih so verjetno izvažali v Evropo v pozni antiki izredno cenjeno vino iz Gaze (Pieri 2005, 110–114).<sup>36</sup>

Amforam LRA 4 lahko na Tonovcovem gradu glede na fakturo pripišemo nekaj narebrenih odlomkov ostenja (t. 72: 5,9; 73: 1–3; 101: 6).

Mlajša oblika tipa Gaza je datirana od 5. do 7. st. (Bonifay, Piéri 1995, 112–113), v Sloveniji so se amfore tega tipa pojavljale v 5. in 6. st. Najdene so bile v Ajdovščini (Vidrih Perko 1994b, Ajdovščina, t. 7: 6,8; 9: 6–7; 10: 7), Piranu (Vidrih Perko 1994a, t. 2: 5,7–9), Acijevem spodmolu (Turk et al. 1992, t. 7: 5), Mostu na Soči (Vidrih Perko 1994b, Most na Soči, Sv. Lucija, t. 1: 5–7). Več primerkov je znanih z Invillina (Mackensen 1987, 246–247, sl. 41: 1–5), najdene so bile tudi v Vidmu (Villa 1998, 284–285, sl. 4: 11–12), Gradežu (Malaguti et al. 2007, sl. 8–10, t. 1: 1–4,6) in Trstu (Auriema 2007, t. 34: 73–74).

#### LRA 5–6

Nekaj amfor s Tonovcovega gradu lahko uvrstimo v tip LRA 5–6. Zanje so značilni cilindričen vrat z neprofiliranim ustjem, vrečasta oblika trupa, prstanasta ročaja in zaobljeno dno. Večina trupa je okrašena z glavničanjem. Zaradi oblike, ki spominja na mehove iz živalskih kož, so imenovane tudi pozne vrečaste amfore (*late bag-shaped amphorae*).

Na Tonovcovem gradu je bilo veliko fragmentov ene vrečaste amfore najdenih na hodni površini na zunanji strani stavbe 1 (t. 70: 5), z izkopnega polja stavbe 1 je znano tudi nekaj narebrenih ostenj, ki verjetno pripadajo temu tipu.

<sup>36</sup> P. Arthur domneva vzrok za veliko popularnost tega vina v pozni antiki tudi v njegovem izvoru v Sveti deželi, zaradi česar naj bi bilo posebno primerno za evharistijo (Arthur 1998, 162).

In Slovenia single-handle (MRA 3) and two-handle (LRA 3) forms appear in towns and rural sites, however the fragmented remains often make it hard to distinguish between the two (Vidrih Perko 2000, 439). They were discovered in Emona (Vidrih Perko 1994b, Emona, Starokrščanski center, 75–76, Pl. 6: 3), Piran (Vidrih Perko 1994a, Fig. 3: 14), at Rodik (Vidrih Perko 1997a, Fig. 2: 38–39), in Štanjel (Vidrih Perko 1997b, Figs. 3: 12; 5: 18), Ajdovščina (Vidrih Perko 1994b, Ajdovščina, Pl. 6: 5–6; Vidrih Perko, Žbona Trkman 2004, Fig. 9: 9,12), at Hrušica (Vidrih Perko 1992b, 349), Školarice (Žerjal 2008, Pl. 50: 1421–1423) and in Črnomelj (Mason 1998, Pl. 2: 3).

They were common in Aquileia (Donat 1994b, 405–407, Pl. 63: AO12–17), and known in hilltop settlements in Friuli, e.g. Invillino (Bierbrauer 1987, Fig. 41: 6), Udine (Buora 1990, 52–53) and Osoppo (Donat 1994b, 405).

#### LRA 4

Amphorae LRA 4 (Gaza amphorae) can be recognised by their characteristic bag-shaped form, the rounded base and the fact that they have no true neck. The rim is rounded or slightly triangular shaped. The body is densely grooved. The handle is small, round and positioned on the shoulder.

They were produced in Gaza and Ashkelon, and most likely used to export wine from Gaza, which was in Late Antiquity extremely popular across Europe (Pieri 2005, 110–114).<sup>36</sup>

At Tonovcov grad only a few ribbed wall fragments can be (according to its fabric) classified as type LRA 4 (Pls. 72: 5,9; 73: 1–3; 101: 6).

The younger form of the Gaza type is dated between the 5<sup>th</sup> and 7<sup>th</sup> century (Bonifay, Piéri 1995, 112–113), and in Slovenia it appears in the 5<sup>th</sup> and 6<sup>th</sup> century. They were discovered in Ajdovščina (Vidrih Perko 1994b, Ajdovščina, Pls. 7: 6,8; 9: 6–7; 10: 7), Piran (Vidrih Perko 1994a, Pl. 2: 5,7–9), Acijev spodmol (Turk et al. 1992, Pl. 7: 5), Most na Soči (Vidrih Perko 1994b, Most na Soči, Sv. Lucija, Pl. 1: 5–7), at Invillino (Mackensen 1987, 246–247, Fig. 41: 1–5), in Udine (Villa 1998, 284–285, Fig. 4: 11–12), Grado (Malaguti et al. 2007, Figs. 8–10, Pl. 1: 1–4,6) and Trieste (Auriema 2007, Pl. 34: 73–74).

#### LRA 5-6

A few amphorae from Tonovcov grad can be placed into type LRA 5-6. This type is known for its cylindrical

<sup>36</sup> P. Arthur assumes that the reason for the great popularity of this wine in Late Antiquity lay also in its origin in the 'Holy Land', which made it especially suitable for the Eucharist (Arthur 1998, 162).

Ker gre pri vrečastih amforah za tipološko in kronološko zelo raznoliko skupino, je predlagana delitev na štiri tipe in na skupino poznih izpeljank. Pri tem oblika LRA 5–6 (klasična vrečasta amfora) ustreza tipu 2 (Pieri 2005, 114–122).

Pojav vrečastih amfor sega v zadnjo četrtino 4. st., na sredozemskem območju so klasične vrečaste amfore značilne za plasti 5. in 6. st. (Pieri 2005, 118), pozne oblike pa segajo še v 7. st. (Keay 1984, 358–359; 1998, 318–319, sl. 9: 5; Pieri 2005, 122).

Delavnice teh amfor so bile na sirsko-palestinskem območju in ob Nilu (Empereur, Picon 1989, 243–245, sl. 26), veljajo pa za vinske amfore (Pieri 2005, 125–127).

V Sloveniji so bile najdene v Kopru (Cunja 1996, 114, t. 27: 297–298), medtem ko so v notranjosti redke. Doslej je bila ena identificirana na emonskem forumu (Vidrih Perko 1994b, Emona, Ferantov vrt, t. 30: 6).

### Amfora Samos–cisterna

Konico (t. 71: 1) bi morda lahko opredelili v tip Samos–cisterna po Paulu Arthurju (1990, 281–295).

Gre za dokaj majhne amfore, za katere so značilni podolgovata, hruškasta oblika trupa, konično rame z nizkim cilindričnim vratom, neprofilirano ali rahlo odebeljeno ustje, dva aplicirana ročaja z vzdolžno kaneluro in konica, ki se (kot v našem primeru) lahko konča z gumbasto odebelitvijo. Ostenje je neenakomerno široko narebreno. Faktura je trda, gladka, sljudnata, barva rjavkasta.

Nekateri avtorji sicer oporekajo opredelitvi tovrstnih amfor v samostojen tip, saj jih npr. D. Pieri vidi le kot manjšo pozno varianto tipa LRA 8 (Pieri 2005, 133–135).

Amfora je po izvoru vzhodnosredozemska, točneje pa izvornega območja ni mogoče opredeliti. Kot možna se omenjata tako otok Samos kot maloazijska obala okoli Halikarnasa (Williams 1990, 295; Pieri 2005, 136). Amfore LRA 8 so bile vinske amfore (Pieri 2005, 136).

Novejše raziskave kronološko uvrščajo amfore tipa Samos–cisterna v čas od druge polovice 6. do druge polovice 7. st. (Arthur 1990, 284–290; Pieri 2005, 135). Težišče njihove razprostranjenosti je bilo v severovzhodnem Sredozemlju, na zahodu so redke (Pieri 2005, 135). V poznem 6. in v začetku 7. st. so bile v severnojadranskem prostoru in v Kampaniji v uporabi predvsem na točkah, ki so bile za Bizanc pomembne pri osvajanju in nadzoru ponovno osvojenega ozemlja (Arthur 1990, 289, sl. 4).

Iz Slovenije je amfora tipa Samos–cisterna znana iz Kopra (Cunja 1996, sl. 31, t. 27: 299), iz severnoitalijanskega prostora pa še iz Vidma (Villa 1998, sl. 4: 16), Oderza (Arthur 1990, sl. 2: 2), Marana (Arthur 1990, sl. 1), Ravene (Stoppioni Picoli 1983, 138, št. 8: 8), Torcella (Toniolo 2007, t. 3b1), verjetno tudi z Invillina (Macken-

neck with a non-defined rim, a bag-shaped body, ring handles and a rounded base. Most of the body is decorated by combed lines. Because of their shape which is reminiscent of bags made from animal skin they are also known as late bag-shaped amphorae.

On Tonovcov grad numerous fragments of a single bag-shaped amphora were found on the floor level on the outer side of building 1 (Pl. 70: 5). The excavation area of building 1 also revealed a few combed walls that most likely belong to this type.

As bag-shaped amphorae represent a typologically and chronologically diverse group, Pieri suggested that they be divided into four types and a group of late derivatives. Form LRA 5-6 (classical bag-shaped amphora) responds to type 2 (Pieri 2005, 114-122).

Bag-shaped amphorae appeared in the last quarter of the 4<sup>th</sup> century, its classical shape became characteristic for the Mediterranean in the 5<sup>th</sup> and 6<sup>th</sup> century (Pieri 2005, 118), while the late forms were produced as late as the 7<sup>th</sup> century (Keay 1984, 358-359; 1998, 318-319, Fig. 9: 5; Pieri 2005, 122).

The workshops of these amphorae were located in the Syro-Palestine area and along the river Nile (Empereur, Picon 1989, 243-245, Fig. 26). They are believed to have been used for wine (Pieri 2005, 125-127).

In Slovenia they were found in Koper (Cunja 1996, 114, Pl. 27: 297-298), but were very rare in the interior of the country. So far a single example has been classified at the Emona forum (Vidrih Perko 1994b, Emona, Ferantov vrt, Pl. 30: 6).

### Amphora Samos–cistern

The base (Pl. 71: 1) could be classified into the type Samos–cistern as defined by Paul Arthur (1990, 281-295).

The characteristics of these relatively small amphorae are a prolonged, pear shaped body, a conical shoulder with a low cylindrical neck, a slightly thickened rim, two handles with longitudinal grooves and a pointy base, which can (as is the case in our example) end with a button-like widening. The wall is unevenly broadly ribbed. The fabric is hard, smooth, with a lot of mica, the color is brown.

Some authors reject the classification of these amphorae into an independent type, for instance D. Pieri sees them merely as a smaller late variant of LRA 8 (Pieri 2005, 133-135).

The type is East Mediterranean in origin; however it is impossible to specify the location more precisely. It is possible that it originates from the island of Samos or the Asia Minor coast around Halikarnas. LRA 8 amphorae were used for storing wine (Pieri 2005, 136).

Later research dates the Samos–cistern amphorae between the second half of the 6<sup>th</sup> century and the sec-

sen 1987, 248–249, t. 41: 7). Ena je bila identificirana tudi na Duelu (Ladstätter 2003, sl. 7: 8).

#### AMFORA JADRANSKEGA IZVORA

Velik odlomek ostenja amfore, ki je ležal na hodni površini stavbe 2 (glej tudi: Tonovcov grad. Naselbinski ostanki in interpretacija, pogl. 2.4) glede na fakturo iz fino prečiščene, bež žgane gline z redkimi grobimi vključki verjetno pripada kateri od severnojadranskih antičnih amfor. Fragment je bil verjetno sekundarno uporabljn kot tegula.

#### AMFORE NEOPREDELJENEGA IZVORA

Neopredeljenih je ostalo 23 % amfor glede na število vseh najdenih, glede na težo pa 15 % vseh najdenih amfor, kar kaže, da so neopredeljeni ostali predvsem manjši kosi (sl. 4.4, 4.5).

#### 4.1.8 SKLEP

Naselbina na Tonovcovem gradu v obeh poznoantičnih fazah kaže močno navezanost na sredozemski prostor.

Uvoženo posodje, ki ga z dokajšnjo gotovostjo lahko postavimo v čas 4. in na začetek 5. st. je – kljub slabi ohranjenosti plasti prve poznoantične faze – dokaj številno (glej tudi: Tonovcov grad. Naselbinski ostanki in interpretacija, pogl. 2.2). Zaradi gradbenega posega na začetku druge poznoantične faze je gradivo močno fragmentirano, večinoma je bil najden le po en kos posamezne posode, v nekaterih primerih pa so bili deli iste posode najdeni v plasteh prve in druge poznoantične faze (v teh primerih so bile pri statistični obdelavi pripisane fazi PA1). Dokaj visok odstotek afriških amfor, ki je bil najden tudi v plasteh druge poznoantične faze, lahko razlagamo kot rezidualno gradivo.

Najstarejši določen tip je amfora *africana* II D (t. 67: 2), ki pa je bila najdena v zgodnj srednjeveški plasti. V plasteh, ki stratigrafsko sodijo v čas pred gradnjo stavbe 1, je bilo najdeno večinoma posodje, ki sodi v čas od sredine 4. st. do sredine 5. st. Nekaj posodja, ki časovno sodi v prvo poznoantično fazo, je bilo najdeno tudi v plasteh druge poznoantične in zgodnj srednjeveške faze, kjer pa ga lahko opredelimo kot rezidualne najdbe (sl. 4.7). Med afriško sigilato so v ta čas datirane oblike Hayes 32/58 in Hayes 61 B, večina afriških amfor (*africana* II C, *tripolitana* III, Keay 25, 26 in 35a) ter glazirana keramika.

Večina uvoženega gradiva iz prve poznoantične faze je na Tonovcov grad prihajala iz severoafriškega prostora. Podobno sliko kažejo tudi druga sočasna nase-

ond half of the 7<sup>th</sup> century. They were most commonly found throughout the northeast Mediterranean, and are rare in the west (Pieri 2005, 135). In the late 6<sup>th</sup> and early 7<sup>th</sup> century they appeared in the North Adriatic and Campania, mainly at locations that were important for the Byzantium in the conquest and control of the reconquered territories (Arthur 1990, 289, Fig. 4).

In Slovenia the type Samos–cistern was found in Koper (Cunja 1996, Fig. 31, Pl. 27: 299), while in Northern Italy it was found in Udine (Villa 1998, Fig. 4: 16), Oderzo (Arthur 1990, Fig. 2: 2), Marano (Arthur 1990, Fig. 1), Ravenna (Stoppioni Picoli 1983, 138, No. 8: 8), Torcello (Toniole 2007, Pl. 3b1), probably also at Invillino (Mackensen 1987, 248–249, Pl. 41: 7). One has also been identified at Duel (Ladstätter 2003, Fig. 7: 8).

#### AMPHORA OF ADRIATIC ORIGIN

Taking into account the fabric from finely purified, beige fired clay with rare coarse inclusions the large amphora fragment that lay on the floor surface of building 2 (see also: Tonovcov grad. Settlement remains and interpretation, chapter 2.4) most likely belongs to one of the North Adriatic amphorae. The fragment was most likely used secondarily as a tegula.

#### UNCLASSIFIED AMPHORAE

23 % (or 15 % if we take the weight into account) of all amphorae remained unclassified, mostly the smaller pieces (Figs. 4.4, 4.5).

#### 4.1.8 CONCLUSION

The settlement on Tonovcov grad shows strong connections with the Mediterranean in both Late Antiquity phases.

Imported pottery that can be placed into the 4<sup>th</sup> and beginning of the 5<sup>th</sup> century with relative certainty is – regardless of the poor state of the Late Antiquity 1 layers – relatively numerous (see also: Tonovcov grad. Settlement remains and interpretation, chapter 2.2). Due to the construction that took place at the beginning of Late Antiquity 2 phase the material was strongly fragmented. In most cases only a single piece of an individual vessel was discovered, and in some cases parts of the same vessel were found in Late Antiquity 1 and 2 layers (in this event they were categorised as LA1 in the statistical analysis). A relatively high share of African amphorae that were found in Late Antiquity 2 layers can be explained as residual finds.

The oldest defined type is the amphora *africana* II D (Pl. 67: 2), which was found in the Early Medieval

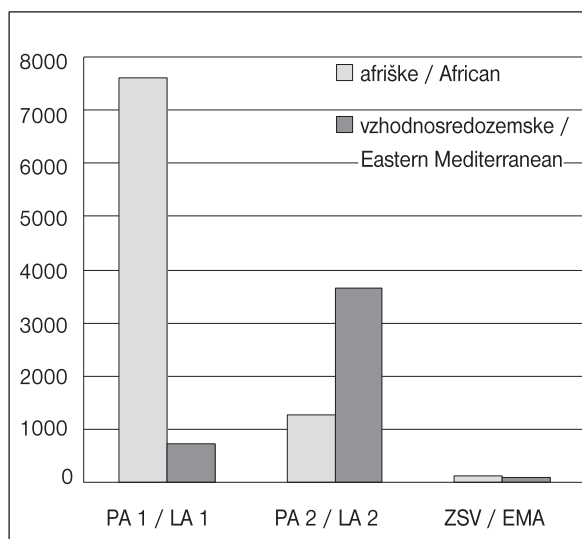

Sl. 4.7: Zastopanost afriških in vzhodnosredozemskih amfor po fazah glede na težo vseh kosov.

Fig. 4.7: African and Eastern Mediterranean amphorae by phases, according to the weight of all pieces.

lja v zaledju zapor (Rodik, Štanjel, Šmarata, Predjama ...), kjer je afriško gradivo povezano z organizirano oskrbo za potrebe vojske (Vidrih Perko 1997b, 257; 2000, 447).

Z vojsko je vsaj v 4. st. povezana tudi glazirana keramika, vendar na Tonovcovem gradu zaradi njene redkosti ne moremo govoriti o organizirani oskrbi. Glazirana keramika je – podobno kot večina navadne namizne keramike – na naselbino verjetno prihajala iz severnojadranskega prostora.

Importi iz vzhodnega Sredozemlja so v prvi fazi redki, pripišemo jim lahko le nekaj primerkov egejskih amfor LRA 3 ter pogojno nekaj odlomkov namizne keramike.

Obdobje druge polovice 5. st. je v keramičnem gradivu slabo zastopano. V ta čas bi od afriških importov lahko uvrstili samo oljenki tipa Hayes II A, ki pa se lahko pojavlja tudi že prej. Glede na redkost gradiva druge polovice 5. st., pa tudi po analogiji s kraškimi najdišči, kjer naselbine večinoma niso preživele sredine 5. st., morda lahko tudi na Tonovcovem gradu domnevamo krajšo opustitev poselitve.

Konec 5. oziroma začetek 6. st. je bil na Tonovcovem gradu čas intenzivne gradbene dejavnosti in hkrati ponovnega množičnejšega pojava uvožene keramike. Najdena je bila skoraj izključno v plasteh druge poznoantične faze, torej v plasteh, ki pripadajo obdobju uporabe objektov. Importi tega obdobja so bili najdeni v vseh do sedaj raziskanih objektih, posebno številni pa so bili na območju stavbe 1. Tu je bilo največ vzhodnomediterranskih amfor najdenih na zunanji strani zidu 4 (sl. 4.8). Amfore iz tega območja so tudi najbolj ohranjene, najdeni so bili številni odlomki posamezne amfore, medtem ko so amfore, najdene na drugih mestih, večinoma zastopane le z enim

layer. In the layers that stratigraphically belong into the period prior to the construction of building 1, mainly vessels that belong between the mid 4<sup>th</sup> and mid 5<sup>th</sup> century were discovered. Some of the vessels that belong into Late Antiquity 1 phase were also found in Late Antiquity 2 and Early Medieval layers, where they can be defined as residual finds (Fig. 4.7). Amongst the African Red Slip Ware Hayes 32/58 and Hayes 61 B are dated into this period, as are most African amphorae (*aficana* II C, *tripolitana* III, Keay 25, 26 and 35a) and glazed pottery.

Most of the imported material from Late Antiquity 1 phase at Tonovcov grad originates from North Africa. A similar situation can be found in other contemporary settlements in the hinterland of *Claustra Alpium Iuliarum* (Rodik, Štanjel, Šmarata, Predjama ...), where African goods were linked to the organised supply of the troops (Vidrih Perko 1997b, 257; 2000, 447).

In the 4<sup>th</sup> century glazed pottery was also linked to the military, however due to its rareness at Tonovcov grad we cannot assume an organised supply. Similar to most tableware found in the settlement, glazed pottery most likely came from the North Adriatic.

During the first phase imports from the East Mediterranean were rare, and only a few examples of Aegean amphorae LRA III and conditionally a few tableware fragments were found.

The second half of the 5<sup>th</sup> century is poorly represented as regards pottery. From African imports only oil lamps type Hayes II A can be placed into this period, however they can also be earlier. Taking into account the rarity of the material from the second half of the 5<sup>th</sup> century and the analogies with the Karst sites (which were in most cases not inhabited after the mid 5<sup>th</sup> century) we could assume a short-term abandonment of the settlement also at Tonovcov grad.

On Tonovcov grad the end of the 5<sup>th</sup> and the beginning of the 6<sup>th</sup> century was a period of intense building activities as well as a period in which imported pottery appeared in greater numbers. This pottery was found almost exclusively in Late Antiquity 2 layers, i.e. in layers that belong to the period in which the objects were used. Imports from this period were found in all buildings that have been researched so far, and they were especially numerous in the excavation area of building 1. Here, most of the Eastern Mediterranean amphorae were discovered on the outer side of the wall 4 (Fig. 4.8). Amphorae from this area were preserved in numerous pieces, while amphorae, found in the other parts of the excavation area, were represented only with one or two fragments. Thus it can be assumed that this was the location of a storage of imported goods.

Although most of the material originates from the East Mediterranean, the connections with Africa still clearly exist. These are indicated by the Hayes II B oil

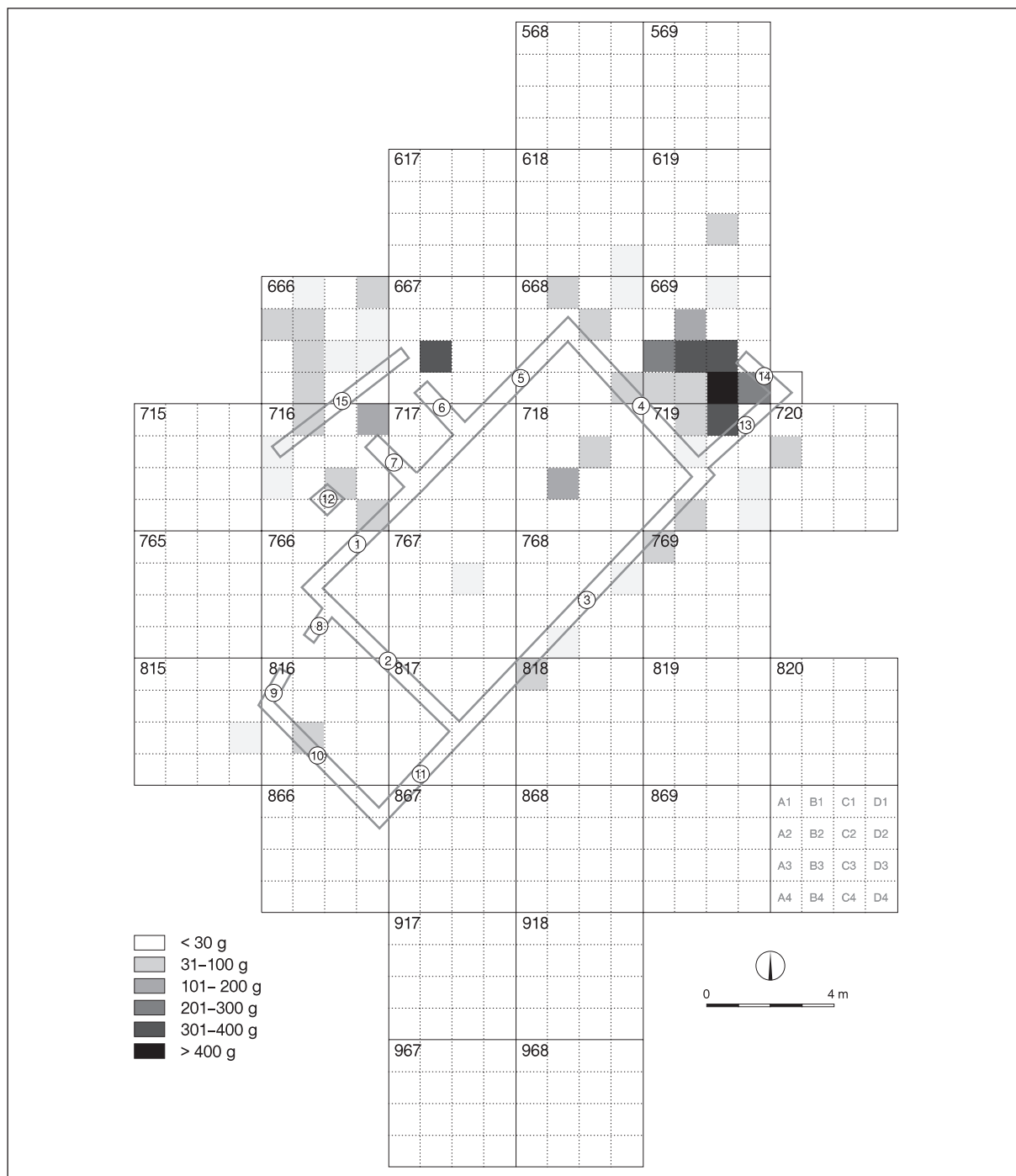

Sl. 4.8: Razprostranjenost amfor v izkopnem polju stavbe 1  
 Fig. 4.8: Distribution of amphorae in the excavation area of building 1.

ali dvema fragmentoma. Vse to morda lahko kaže na shranjevanje uvoženega blaga na tem mestu.

Čeprav večina gradiva tega obdobja izvira iz vzhodnega Sredozemlja, so bile tudi vezi z afriškim prostorom očitno še žive. Nanje kažejo oljenke tipa Hayes II B in ne povsem zanesljivo določeni skledi Hayes 87 oziroma 87/109 in Hayes 99 ter krožnik Hayes 89 ali 90 oziroma 104 ali 105.

lamps, the unreliably classified Hayes 87 or 87/109 and Hayes 99 bowls, and the Hayes 89/90 or 104/105 plate.

Amphorae are the most commonly found East Mediterranean import. LRA 1, LRA 2, LRA 4 and LRA 5/6 can appear as early as the second half of the 5<sup>th</sup> century, however their main expansion took place in the 6<sup>th</sup> century. Such amphorae from this period were often found also in other Southeastern Alpine settlements.

Med vzhodnosredozemskimi importi močno prevladujejo amfore. LRA 1, LRA 2, LRA 4 in LRA 5/6 se lahko sicer pojavljajo že v drugi polovici 5. st., vendar je bil njihov glavni razmah v 6. st. V tem času so dokaj pogosto gradivo tudi na ostalih naselbinah jugovzhodnoalpskega kroga.

V časovni sklop vzhodnih importov lahko uvrstimo tudi za zdaj en sam znan primer produkcije LRC oziroma fokejske sigilate.

Najmlajše so najdbe poznih malih spatejonov in domnevne amfore tipa Samos–cisterna. Oboji so značilni za drugo polovico 6. st., po nekaterih datacijah se pozne variante vlečejo še skozi vse 7. st. Na Tonovcovem gradu stratigrafski položaj teh poznih importov kaže bolj na čas druge polovice 6. st. Tako lahko zakop malega spatejona v osrednji cerkvi na podlagi Justinijanovega srebrnika, najdenega v njem, postavimo v sredino 6. st., v čas po gotško–bizantinskih vojnah. V ta kontekst se dobro vklaplja tudi domnevna amfora tipa Samos–cisterna. Amfore tega tipa so bile razširjene predvsem na strateško pomembnih mestih za Bizanc (Arthur 1990, 289). V Furlaniji in širše v severni Italiji amfore tipa Samos in pozni mali spatejoni pogosto nastopajo skupaj (npr. Videm, Marano Lagunare, Ravenna: glej Villa 1998, 276–286).

Importi v 6. st. verjetno niso bili več povezani z organizirano oskrbo, so pa dokaz o še vedno živih trgovskih stikih s sredozemskim prostorom.

Časa opustitve naselbine na Tonovcovem gradu na podlagi keramičnih importov ne moremo določiti. Prva polovica 7. st. je namreč obdobje, ko sredozemski proizvodi prenehajo prihajati na jugovzhodnoalpsko območje, komunikacija s Sredozemljem je povsem prekinjena. Ta prekinitev verjetno sovpada tudi s prekinitvijo življenja na naselbini.

## 4.2 GROBA KERAMIKA

Na Tonovcovem gradu – tako kot na mnogih ostalih poznoantičnih najdiščih vzhodnoalpskega in severnojadranskega prostora – med izkopanim keramičnim gradivom močno prevladuje groba keramika (Bierbrauer 1987; Santoro Bianchi 1995; Cunja 1996; Ciglencečki 2000; Ladstätter 2000). Na Tonovcovem gradu zavzema 87 % glede na število značilnih kosov (*sl.* 4.3).

Groba keramika predstavlja veliko in precej nenotno skupino keramike, za katero je značilna relativna grobost izdelave, saj vsebuje velike ali srednje velike vključke in je pogosto nehomogena, krhka in drobljiva. Uporabljena je bila v glavnem kot kuhinjska keramika, torej pretežno za uporabo na ognju in za shranjevanje živil, nekatere oblike pa tudi za strežbo.

Kljub številnim študijam, ki so bile v zadnjem obdobju posvečene antični keramiki grobe fature, še vedno ni enotnega poimenovanja zanjo. V Sloveniji se poleg izraza *groba keramika*, ki je v zadnjem času naj-

The so far only known example of LRC production or Phocaeen Red Slip Ware can also be placed amongst the eastern imports from this period.

The most recent are the finds of the late small spatheia and the assumed amphora type Samos–cistern. Both are characteristic of the second half of the 6<sup>th</sup> century, and according to some the late variants reach throughout the 7<sup>th</sup> century. The stratigraphic position of these late imports at Tonovcov grad dates them more into the second half of the 6<sup>th</sup> century. Thus the burial of the small spatheion in the main church can be dated into the mid 6<sup>th</sup> century – in the time after the Gothic – Byzantine wars. This date was confirmed by the Justinian's silver coin that was found within the spatheion. This context also fits the assumed amphora type Samos–cistern. Amphorae of this type appear mainly in locations that were strategically important for the Byzantium (Arthur 1990, 289). In Friuli and elsewhere in Northern Italy amphorae type Samos and the late small spatheia often appear together (e.g. Udine, Marano Lagunare, Ravenna: see Villa 1998, 276–286).

In the 6<sup>th</sup> century imports are most likely no longer linked to organised supply, however they are proof that trade with the Mediterranean remained lively.

It is impossible to determine when the settlement on Tonovcov grad was abandoned with the help of the ceramic imports. In the first half of the 7<sup>th</sup> century Mediterranean products stop coming to the Southeastern Alps, and communication with the Mediterranean was completely interrupted. This interruption most likely coincided with the abandonment of the settlement.

## 4.2 COARSE WARE

Similar to many other Late Antique sites in the Eastern Alps and the North Adriatic, coarse ware was the most commonly found pottery also at Tonovcov grad (Bierbrauer 1987; Santoro Bianchi 1995; Cunja 1996; Ciglencečki 2000; Ladstätter 2000), where it represents 87 % of diagnostic sherds (*Fig.* 4.3).

Coarse ware represents a large and rather non-unified pottery group, with a characteristic coarse manufacture that might include large or medium size inclusions, it is often fragile, flaky and non-homogenous. It was predominantly used as kitchenware, i.e. mostly for storing food or preparing it over the fireplace, however some forms were also used for serving.

Regardless of the numerous studies that have lately been dedicated to antique coarse ware, we still lack a unified terminology. In Slovenia the term coarse ware, is currently the most commonly used term in archaeological literature (Ciglencečki 2000), however terms such as coarse house pottery, house ware, kitchen ware also appear (Pahič 1980; Mikl-Curk 1973; 1983). In this paper we will use the term coarse ware, which describes the

pogosteje uporabljen v arheološki literaturi (Ciglenečki 2000), uporabljajo tudi izrazi *groba hišna lončenina*, *hišna keramika*, *kuhinjska keramika* (Pahič 1980; Mikl-Curk 1973; 1983). V nadaljevanju bomo uporabljali izraz groba keramika, ki opisuje bistveno lastnost obravnava-nega posodja, hkrati pa ne prejudicira niti načina njene uporabe (za kuhanje, za strežbo ali za shranjevanje) niti kraja in načina nastanka (lokalni, regionalni ali nadre-gionalni izvor).

V nemški literaturi se za to vrsto posodja ravno tako uporablja več poimenovanj, npr. *Grobkeramik* (Ladstätter 2000), *Gebrauchskeramik* (Rodriguez 1997) in *Hauskeramik* (Bierbrauer 1987).

V Italiji sta najpogosteje uporabljana izraz *ceramica grezza* in *rozza terracotta scura*, v zadnjem času pa se uveljavlja skupni izraz navadna keramika – *ceramica comune*, *ceramiche comune* (Massa, Portulano 1999; Cortese 2005) kot skupno ime za veliko skupino kera-mike, neobhodno potrebno za vsakdanje aktivnosti, ki ustreza zahtevi minimalni stroški – maksimalni učinek. Ta velika skupina se deli na podskupine, kot so groba keramika – *ceramica grezza*; prečiščena keramika – *ceramica depurata*; glazirana keramika – *ceramica invetriata*.

Na angleškem govornem področju izraz *coarse ware* obsega veliko skupino keramike brez premaza, ki se uporablja za kuho, za postrežbo in za pripravo hrane (Fulford, Peacock 1994, 155) in tako ustreza italijanske-mu izrazu *ceramica comune*.

Poznoantična groba keramika je kljub navidezni neatraktivnosti predvsem v zadnjih desetletjih postala priznana kot pomemben vir informacij o prehranje-valnih in življenjskih navadah, tehnološkem znanju in organizaciji proizvodnje v posameznih skupnostih na področju celega rimskega imperija (Santoro Bianchi 2005, 327). V okviru objav materiala tako zavzema vse bolj pomembno mesto.

Neke vrste mejnik pri obdelavi poznoantične grobe keramike v vzhodnoalpskem prostoru vsekakor pome-ni delo Volkerja Bierbrauerja o Invillinu, kjer je avtor obdelal zelo veliko količino grobe keramike in postavil podrobno tipologijo oblik, ki temelji predvsem na za-ključkih ustij (Bierbrauer 1987). Keramični material je razdelil v tri skupine. Prva obsega skodele in skodele, ki jih je potem razdelil na 9 osnovnih tipov s podtipi, druga kozarce, tretja pa lonce in lončke, ki jih je razdelil na 11 osnovnih tipov s podtipi. Te tipe je potem skušal kronološko določiti na podlagi stratificiranih najdb posameznih naselbinskih period. Študija v veliki meri bazira na tipološki klasifikaciji, tehnologija pa igra se-kundarno vlogo (Bierbrauer 1987, 187–224).

V Furlaniji je monografsko obdelano tudi gradivo s Castelraimonda, večslojnega najdišča v dolini Tilmenta (Santoro Bianchi 1995), kjer je bilo veliko pozornosti posvečene tudi metodologiji obdelave gradiva, tako s tehnološkega kot tipološkega stališča. Zaradi težnje po čim večji empiričnosti so se izognili klasični tipološki

essential characteristic of the treated pottery, and at the same time does not prejudice as regards its use (cooking, serving or storage) location or origin (local, regional or broader origin).

German literature also displays a variety of terms for such pottery, e.g. *Grobkeramik* (Ladstätter 2000), *Gebrauchskeramik* (Rodriguez 1997) and *Hauskeramik* (Bierbrauer 1987).

In Italian the most commonly used terms are *ceramica grezza* and *rozza terracotta scura*, and lately the term common ware – *ceramica comune*, *ceramiche comune* (Massa, Portulano 1999; Cortese 2005) – is being introduced as a collective name for the large group of pottery vessels used in everyday activities that fit the minimal costs – maximal effect demand. This large group is divided into subgroups, such as coarse ware – *ceramica grezza*; purified ware – *ceramica depurata*; glazed pottery – *ceramica invetriata*.

In the English speaking territories the term *coarse ware* covers the large group of non-glazed pottery used for preparing, cooking and serving food (Fulford, Peacock 1994, 155) and could thus be said to correspond to the Italian term *ceramica comune*.

Regardless of its seeming unattractiveness Late Antique coarse ware has become recognised as an important source of information on eating and living habits, technological knowledge and the organisation of production in individual communities throughout the Roman Empire (Santoro Bianchi 2005, 327), which is why it has over the past few decades started to occupy an increasingly important place within the publications of the archaeological finds.

Volker Bierbrauer's work on Invillino, in which he treated a large quantity of coarse ware and set a detailed typology of forms, predominantly based on rim endings, represented a milestone in the classification of Late An-tique coarse ware in the Eastern Alps (Bierbrauer 1987). He divided the pottery into three large groups. The first one consists of bowls and cups that he divided into 9 basic types with subtypes, the second group consists of beakers and the third group consists of pots that he divided into 11 basic types with subtypes. He then attempted to chronologically define these types on the basis of the stratified finds within the individual settlement periods. His study is predominantly based on typological classifica-tion, while technology plays a secondary role (Bierbrauer 1987, 187–224).

The material from Castelraimondo was treated in an independent publication. Castelraimondo is a multi-layer site in the valley of Tagliamento (Santoro Bianchi 1995), where great attention has been paid to the methodology of the treatment, from the technological as well as typological aspect. Due to their aspiration to pay great attention to the empirical aspect they avoided the classical typological treatment of the material. They presented merely the basic forms from the site, and did

obravnavi gradiva. Predstavili so le osnovne oblike posod z najdišča, ne da bi pri tem sugerirali njihovo kronološko ali funkcionalno vrednost. Na področju tehnoloških analiz so bile poleg makroskopskih opazovanj keramike izvedene tudi arheometrične analize (Failla 1995, 95–118).

Tudi pri objavah drugih severnoitalijanskih najdišč (Brescia, Milano) je v zadnjem času opaziti izogibanje klasični tipološki metodi, čeprav se določeni klasifikaciji gradiva v skupine tudi tu niso mogli izogniti (Massa, Portulano 1999, 146–148; Della Porta, Sfredda, Tassinari 1998, 133–249).

Helgard Rodriguez je v neobjavljeni disertaciji obdelala keramično gradivo s Kirchbichla pri Lavantu (Rodriguez 1986), kjer se je delno naslonila na Bierbrauerjevo razdelitev, več poudarka pa je namenila tudi razvoju okrasja, predvsem valovnice. Ista avtorica je objavila še več člankov o primerjavi grobe keramike z različnih jugovzhodnoalpskih najdišč Avstrije, Italije in Slovenije (Rodriguez 1992; 1997).

Keramiko z najdišča Duel je obdelala Ulla Steinklauber (1990), z najdišča Kappele pa Sabine Felgenhauer-Schmiedt (1993). Groba keramika obsega tudi pomemben del pri monografski obdelavi zahodnega cerkvenega kompleksa na Sv. Hemi (Ladstätter 2000). Avtorica poleg tipologije oblik precej pozornosti nameni tudi načinu priprave surovine, izdelavi in pečenju posod. Oblikovno je grobo keramiko razdelila na lonce (7 oblik s podskupinami), lončke in kozarce (6 oblik s podskupinami), skleda in skodele (11 oblik s podskupinami), krožnike, vrče in pokrove (Ladstätter 2000, 135–150).

Na slovenskem področju se je prvi temeljiteje ukvarjal z grobo antično keramiko Stanko Pahič in sicer tako s tipologijo (Pahič 1978, 129–298) kot s tehnologijo (Pahič 1980, 388–437). Z razvojem raziskav poznoantičnih višinskih postojank so se množile tudi objave keramičnega gradiva z njih, npr. z Ajdovskega gradca nad Vranjem (Knific 1979, 732–785), delne objave najdb z Gradca pri Prapretnem, Korinjskega hriba nad Velikim Korinjem in Tinja nad Loko pri Žusmu (Ciglencečki 1984, 313–328; 1985, 255–284), keramične najdbe pa zavzemajo pomembno mesto tudi v monografskih obdelavah Kapucinskega vrta v Koprju (Cunja 1996), Kučarja nad Podzemljem (J. Dular, Ciglencečki, A. Dular 1995) in Tinja nad Loko pri Žusmu (Ciglencečki 2000). Pri obdelavi keramike s pomembnega poznoantičnega in zgodnesrednjeveškega najdišča Tinje nad Loko pri Žusmu je avtor tipološko razdelil keramiko na pet osnovnih tipov loncev in tri tipe skled. Pri oblikovno-tipološki razdelitvi mu je bil vodilni kriterij oblikovanost celotnega zgornjega dela posode – ustja, vratu in ramen. V primerjalni študiji je zajel tudi bogat izbor primerljivih keramičnih najdb z jugovzhodnoalpskega in severnojadranskega prostora (Ciglencečki 2000).

not suggest their chronological or functional value. In the field of technological analyses the pottery underwent macroscopic observation and archeometric analyses (Failla 1995, 95–118).

It can be noticed that the recent publications dealing with other North Italian sites (Brescia, Milano) also avoid the classical typological method, even though they could not completely avoid the classification of materials into groups (Massa, Portulano 1999, 146–148; Della Porta, Sfredda, Tassinari 1998, 133–249).

In her unpublished doctoral thesis Helgard Rodriguez classified the pottery from Kirchbichel near Lavant (Rodriguez 1986). In her classification she partially leaned upon the division by Bierbrauer, but paid greater attention to the development of the decoration, especially wavy lines. She also published numerous articles in which she compared coarse ware from various Southeastern Alpine sites in Austria, Italy and Slovenia (Rodriguez 1992; 1997).

Ulla Steinklauber analysed the pottery from the site of Duel (Steinklauber 1990), and Sabine Felgenhauer-Schmiedt analysed the pottery from Kappele (Felgenhauer-Schmiedt 1993). Coarse ware also covers an important part in the monograph publication dealing with the west ecclesiastical complex on Hemmaberg (Ladstätter 2000). Apart from classifying the typology of forms the author also spent great attention on the manner in which the raw material was prepared, as well as the pottery preparation and firing. As regards the shape she divided coarse ware into pots (7 forms with subtypes), small pots and beakers (6 forms with subgroups), bowls and cups (11 forms with subgroups), plates, jugs and lids (Ladstätter 2000, 135–150).

In Slovenia Stanko Pahič was the first to deal with Antique coarse ware in greater detail; he dealt with typology (Pahič 1978, 129–298) as well as technology (Pahič 1980, 388–437). With the development of the research of Late Antique hilltop posts the publications on pottery from these sites multiplied, e.g. Ajdovski gradec above Vranje (Knific 1979, 732–785), partial publication of the finds at Gradec near Prapretno, Korinjski hrib above Veliki Korinj and Tinje above Loka pri Žusmu (Ciglencečki 1984, 313–328; 1985, 255–284). Pottery finds play an important role in the monograph publications on Kapucinski vrt in Koper (Cunja 1996), Kučar above Podzemelj (J. Dular, Ciglencečki, A. Dular 1995) and Tinje above Loka pri Žusmu (Ciglencečki 2000). In his analysis of the key Late Antique and Early Medieval site Tinje above Loka pri Žusmu the author typologically categorised pottery into five basic pot types and three bowl types. As regards the typological division of the design his main criterion was the shape of the entire upper part of the vessel – the rim, neck and shoulder. In the comparative analysis he also included the rich selection of comparable pottery finds from the Southeastern Alps and the North Adriatic (Ciglencečki 2000).



## 4.2.1 TEHNOLOGIJA

Velike količine izkopenega keramičnega gradiva so nujno pripeljale do poskusov razvrščanja tega gradiva glede na značilnosti snovi, iz katere je bila keramika narejena, z namenom uvrščanja posameznih odlomkov v skupine. Prvi pogoj za tako razvrščanje je objektivno in enotno podajanje vseh spremenljivk, ki definirajo značilnosti posameznega kosa lončenine. Le tako so omogočene nadaljnje študije – primerjave tipov znotraj najdišča, med posameznimi najdišči, identifikacije značilne produkcije, določanje kronološkega in geografskega okolja, pa tudi arheometrične raziskave.

Poskusi tehnoloških analiz imajo najdaljšo tradicijo na angleškem govornem področju (Peacock 1977, 26–32; Orton, Tyers, Vince 1993). Prvi poizkus poenotenja kriterijev za opisovanje tehnoloških značilnosti keramike pomeni delo D. P. S. Peacocka (1977, 26–33). V kontinentalni Evropi se je študij tehnologije sprva razvijal predvsem v povezavi s študijem amfor in fine keramike (glej pogl. 4.1), leta 1985 pa je izšlo prelomno delo Ninine Cuomo di Caprio *La ceramica in archeologia* (Cuomo di Caprio 1985), ki je bilo v prenovljeni in razširjeni obliki ponovno izdano leta 2007 (Cuomo di Caprio 2007).

Posebno od 80-ih let dalje je opazna težnja k poenotenju dokumentacijskega sistema (Peacock 1977; Schneider 1989, 5–39). Metode so večinoma prevzete iz geologije in na različne načine prilagojene za uporabo v arheologiji (Peacock 1977, 26).

Vzporedno so se razvijale arheometrične metode, ki se (z določenimi omejitvami) lahko uporabljajo kot pomoč pri dataciji keramičnega gradiva, pri študiju izvora keramike ali funkcije posod (Orton, Tyers, Vince 1993, 18–22; Cuomo di Caprio 2007, 571–652).

V Slovenji se je s tehnologijo keramike in sicer z grobo hišno lončenino prvi sistematično ukvarjal Stanko Pahič (1980, 388–437). Obsežna navodila za definiranje, standardiziranje in dokumentiranje keramike ne glede na obdobje je predložila Milena Horvat (Horvat 1999). Z analizo tehnoloških značilnosti rimske keramike na primeru grobne keramike s Ptuja se je ukvarjala Janka Istenič, ki je kombinirala makroskopsko dobljene podatke tudi z izsledki arheometričnih raziskav (Istenič 1999; Daszkiewicz, Schneider 1999).

Tehnološke značilnosti keramičnih fragmentov so posledica produkcijskega procesa, ki obsega več stopenj, vse od izbora gline dalje. Posamezne stopnje tega procesa se lahko razlikujejo tako znotraj enega časovnega obdobja kot skozi daljši čas. Nekatere take razlike so vidne tudi pri makroskopskem opazovanju, medtem ko je druge možno določiti šele z arheometričnimi metodami.

Groba keramika s Tonovcovega gradu je značilna naselbinska keramika in pri njeni obdelavi smo se srečevali z vsemi omejitvami tovrstnega gradiva. Velika fragmentarnost otežuje prepoznavanje oblik in tehnolo-

## 4.2.1 TECHNOLOGY

The large quantities of excavated pottery lead to attempts of classifying these finds according to the characteristics of the used materials, with the intention of categorising individual fragments into groups. The first condition for such a division is to present objectively and in a unified way the variables that define the characteristics of an individual fragment of pottery. Only this makes further studies (i.e. comparisons of the types within a site, amongst individual sites, identification of the characteristic production, defining the chronological and geographic environment, as well as conducting archeometric research) possible.

English speaking environment has the longest tradition in attempting to come up with a technological analysis (Peacock 1977, 26-32; Orton, Tyers, Vince 1993). The first attempt to unify the criteria for describing technological activities used for pottery is represented in the work by D. P. S. Peacock (1977, 26-33). In continental Europe the study of technology was at first developed in relation to the studies of amphorae and fine ware (see chapter 4.1). In 1985 Ninina Cuomo di Caprio published her breakthrough work entitled *La ceramica in archeologia* (Cuomo di Caprio 1985), which was revised and expanded in 2007 (Cuomo di Caprio 2007).

From the 1980s onwards there is a noticeable tendency to unify the documentation system (Peacock 1977; Schneider 1989, 5-39). Most of the methods are adopted from geology and are in various ways adapted for use in archaeology (Peacock 1977, 26).

Parallel archeometric methods have been developed, and these can (with certain limitations) be used to help to date pottery, as well as determine its origin or function (Orton, Tyers, Vince 1993, 18-21; Cuomo di Caprio 2007, 571-652).

Stanko Pahič was the first to systematically deal with pottery technology in Slovenia (coarse house ware; Pahič 1980, 388-437). Milena Horvat proposed comprehensive instructions for defining, standardising and documenting pottery regardless of the period of their origin (Horvat 1999). Janka Istenič analysed the technological characteristics of Roman pottery on the example of the pottery from the cemeteries in Ptuj (Poetovio), where she combined the macroscopically obtained data with the findings obtained from archeometric research (Istenič 1999; Daszkiewicz, Schneider 1999).

The technological characteristics of pottery fragments are a consequence of a production process that incorporates a number of phases, from the selection of clay onwards. The individual phases of this process can differ within a period as well as over a longer period of time. Some of these differences are visible already through macroscopic observation, while others can merely be defined by archeometric methods.

Coarse ware from Tonovcov grad is characteristic settlement pottery and in our treatment of it we have

loških značilnosti, precej gradiva ne izvira iz zaprtih kontekstov, pogosti so rezidualni kosi, nekatere oblike in tehnološke značilnosti pa kažejo dolgo trajanje in s tem onemogočajo točnejšo datacijo.

Pri tehnološki obdelavi gradiva smo se omejili na makroskopsko opazovanje, ki smo ga v nejasnih primerih dopolnili z opazovanjem pod lupo. Zaradi specifičnosti gradiva smo izdelali lasten klasifikacijski sistem, pri katerem smo upoštevali izkušnje različnih tehnoloških klasifikacijskih shem (Schneider 1989; Orton, Tyers, Vince 1993; Horvat 1999), ki smo jih priredili danim možnostim, predvsem pa značilnostim obdelovanega gradiva.

Tehnološke značilnosti so bile določene vsem značilnim kosom (ustja, dna, ostenja z ornamentom in ročaji), saj bi obdelava vse najdene keramike (okrog 10.000 fragmentov) presežala dane možnosti. V primeru, ko je več keramičnih fragmentov nesporno pripadalo eni posodi, smo jih obravnavali kot en kos. Na ta način je bilo obdelanih približno 1100 kosov keramike.

Vsakemu fragmentu smo določili barvo, način žganja, vrsto dodatkov, velikost dodatkov, obliko dodatkov, pogostost dodatkov, poroznost, trdoto in obdelavo površine ter način izdelave (ročno, počasno ali hitro vreteno).

*Barva:* Barvo smo določali opisno in sicer na zunanji in notranji strani ter v jedru (na svežem prelomu). V novejšem obdobju večina avtorjev sicer priporoča uporabo barvnih kart, večinoma Munsellove barvne lestvice (Munsell 2000; Horvat 1999, 55–56; Orton, Tyers, Vince 1993, 68, 136–138; Cuomo di Caprio 2007, 681–688), vendar le-te za obravnavano keramiko niso bile primerne. Barva keramike je namreč izredno neenotna, tako da je v nekaterih primerih na enem odlomku lahko prisotnih tudi nekaj različnih barv. Celo v primeru, da barvo lahko določimo npr. kot rjavo, je na fragmentu ponavadi več odtenkov. Pri tej odločitvi smo upoštevali tudi dejstvo, da je barva lahko odvisna tudi od različnih slučajnih vzrokov, predvsem od položaja posode na ognju po žganju,<sup>37</sup> pa tudi od postdepozicijskih procesov, tako da nam ne kaže vedno zanesljivo določenega tehnološkega postopka. To dokazujejo tudi primeri iste posode popolnoma različnih barv.

*Način žganja:* Določali smo ga po barvi površine in jedra (Horvat 1999, 53). Makroskopsko ugotavljanje načina žganja je sicer zaradi odvisnosti od barve lahko problematično (glej zgoraj). V mnogih primerih se atmosfera žganja z gotovostjo lahko opredeli šele pri laboratorijskem ponovnem žganju (Schneider 1989, 13–14, 23–24; Daszkiewicz, Schneider 2001).

<sup>37</sup> Pogosta je počrnitev posode v spodnjem delu, ki nam lahko kaže tudi način, kako je bila postavljena na ogenj. Če je počrnela na notranji in zunanji strani, ne pa na dnu, pomeni, da je bila postavljena direktno na ogenj ali na vroč pepel, če pa je dno popolnoma počrnelo, pa je bila posoda postavljena nad ogenj na nekem oporniku (Cortese 2005, 344).

encountered all of the limitations of such material. As a large share of the discovered material was found in small fragments it was hard to recognise the shapes and technological characteristics. A lot of the material does not originate from closed contexts and residual pieces are also common. Some shapes and technological characteristics appeared over a long period of time and thus do not enable precise dating.

In our technological treatment of the pottery we limited ourselves to macroscopic observation which was expanded to observation with a magnifying glass when necessary. Due to the pottery's special characteristics we formed a new classification system. Of course, we took into account the experience gained from various technological classification schemes (Schneider 1989; Orton, Tyers, Vince 1993; Horvat 1999), and then adjusted them to the given possibilities, and especially to the characteristics of the treated material.

As it would be impossible to categorise all of the discovered pottery fragments (approximately 10,000) we defined the technological characteristics for all diagnostic sherds (rims, bases, handles and walls with ornaments). In the event that a large number of fragments undoubtedly belonged to a single vessel, they were treated as a single piece. Approximately 1100 pottery fragments were treated in this way.

Each fragment was defined by the following parameters: colour, type of firing, type of mineral inclusions, size of mineral inclusions, shape of mineral inclusions, frequency of mineral inclusions, porosity, hardness and treatment of the surface and type of manufacture (hand made, slow or quick potter's wheel).

*Colour:* The colour was defined descriptively for the outer and inner walls as well as for the core (on the fresh fracture). Recently authors have started to recommend the use of colour charts, most commonly the Munsell's colour chart (Munsell 2000; Horvat 1999, 55–56; Orton, Tyers, Vince 1993, 68, 136–138; Cuomo di Caprio 2007, 681–688), however we did not find them useful in our case. The colour of the pottery is extremely non-unified, thus different colours can be found on a single fragment. Even in the event that the colour could be defined – for instance as brown – the fragment was usually covered by numerous nuances. In our decision we also took into account the fact that the colour might also depend on various accidental causes, i.e. how the vessel was placed onto the fire once it had been fired,<sup>37</sup> or post-depositional processes, thus it is not always a reliable indication of a

<sup>37</sup> It is common for the vessels to be blackened at the bottom, and this can indicate the manner in which it was placed onto the fire. Blackening of the interior and exterior, but not of the base, is a result of the vessel being placed directly onto the fire or hot ashes, while if the base is completely blackened, the vessel was placed above the fire, with the aid of some sort of a holder (Cortese 2005, 344).

*Vrsta dodatkov:* Določali smo apnenec, kremen, sljudo, organske snovi, železove okside, zdrobljeno keramiko. Nekateri dodatki so ostali nedefinirani. Za razločevanje med kalcitom in kremenom smo uporabljali 10% hladno HCl. Močno prevladujejo kalcitni dodatki, kremen je redek, še bolj redko smo lahko ugotovili zdrobljeno keramiko in organske snovi.

*Velikost dodatkov:* Na podlagi ocene velikosti zrn v jedru je bilo določenih pet razredov: do 0,25 mm zelo fina; od 0,26–0,50 mm fina; od 0,51–1,0 mm drobna; od 1,1–2,0 mm groba; nad 2,0 mm zelo groba.

*Pogostost dodatkov:* Gre za povprečno število zrn dodatka na  $\text{cm}^2$  v jedru. Določili smo štiri razrede: brez vidnih primesi; redka (do 5 zrn/ $\text{cm}^2$ ); zmerna (5–10 zrn/ $\text{cm}^2$ ); obilna (nad 10 zrn/ $\text{cm}^2$ ). Tudi pri določanju tega parametra se pojavljajo težave, saj se pogostost dodatka na posamični posodi lahko spreminja. Dodatki se pogosto zgostijo na prehodu iz ostenja v dno in na dnu, medtem ko so na zgornjem delu posode redkejši.<sup>38</sup>

*Poroznost:* Beležili smo jo s pomočjo enake skale kot velikost dodatkov (glej zgoraj). Odvisna je od sestave glin, vrste dodatkov, temperature in dolžine žganja, pa tudi, podobno kot barva, od postdepozicijskih procesov. Tako imajo lahko črepinje iste posode, ki so se po prenehanju uporabe nahajale v različnih postdepozicijskih pogojih, popolnoma drugačno ohranjenost površine.

*Trdota:* Določali smo jo po usklajeni Mohsovi lestvici: mehka (razi jo noht); trda (razi jo nož); zelo trda (razi jo steklo); izredno trda (razi steklo). Pojavljali sta se samo prvi dve stopnji, medtem ko zelo trde in izredno trde med obravnavano keramiko ni bilo.

*Izdelava:* Način izdelave (prostoročno, na počasnem vretenu, na hitrem vretenu) se določa na podlagi sledov na ostenju posode. Načelno se pripisuje ročnemu vretenu izdelke grobe izdelave, neenotne debeline, medtem ko uporabo hitrega vretena kažejo horizontalne tanke linije in pravilne brazde, vendar je take sledove lahko izbrisala naknadna obdelava površine (Cortese 2005, 330 s). Zato smo kose, ki niso imeli izrazitih vodoravnih sledi v notranjosti posode, pogojno opredelili kot izdelane na počasnem vreten. Nekateri kosi kažejo sledove različnih tehnik. Pojavljajo se primeri, ki v spodnjem delu kažejo sledove izdelovanja na roko, na zgornjem pa sledove vodoravnih potevov, značilne za izdelavo na vretenu. V takih primerih gre za kombinirano tehniko izdelave (ročno z dodelavo na vretenu).

Glede na zgoraj opisane parametre smo v nadaljevanju oblikovali tehnološke skupine (TS), katerih prvi cilj je bil lažje obdelovanje gradiva, v naslednji stopnji pa smo skušali poiskati morebitne povezave tehnoloških

specific technological process. This is proven also by the discovered examples of the same vessel, but with totally different colours.

*Firing method:* Was defined by the colour of the surface and the core (Horvat 1999, 53). It can be problematic to ascertain the firing method merely by macroscopic observation, for this depends strongly on the colour (see above). In many cases the atmosphere of the firing can be ascertained only by laboratory re-firing Schneider 1989, 13-14, 23-24; Daszkiewicz, Schneider 2001).

*Type of mineral inclusions:* We found calcite, quartz, mica, organic matter, iron oxide, and crushed pottery. Some inclusions remained undefined. In order to differentiate between calcite and quartz we used 10% cold HCl. Calcite inclusions prevailed, quartz was rare, and even rarer were crushed pottery and organic matter.

*Size of mineral inclusions:* Five classes were ascertained on the basis of the estimate of the grain size in the core: very fine – up to 0.25 mm; fine – between 0.26 and 0.50 mm; small – between 0.51 and 1.0 mm; coarse – between 1.1 and 2.0 mm; very coarse – 2.0 mm or more.

*Mineral inclusions frequency:* This represents the average number of grains of mineral inclusions per  $\text{cm}^2$  in the core. Four classes were established: with no visible inclusions; rare (up to 5 grains/ $\text{cm}^2$ ); relatively common (5-10 grains/ $\text{cm}^2$ ); abundant (10 grains or more/ $\text{cm}^2$ ). Problems also arose with this parameter, for the frequency of the mineral content could change throughout an individual pottery fragment. The mineral content is often denser at the transition between the walls and the base and in the base, and rarer towards the top of the vessel.<sup>38</sup>

*Porosity:* We recorded it with the same scale we used for inclusion size (see above). It depends on the clay composition, type of inclusions, temperature at the time of firing, as well as – similar to colour – on the post-depositional processes. Thus fragments of the same vessel, if they were deposited in various conditions once they were no longer in use, can have their surface preserved totally differently.

*Hardness:* We used the Mohs scale to define this category: soft (can be scratched by a fingernail); hard (can be scratched by a knife); very hard (can be scratched by a window glass plate); extremely hard (scratches window glass plate). Only the first two levels appeared, while no very hard or extremely hard pottery was discovered.

*Manufacture:* Manufacture (hand made, on a slow potter's wheel, on a fast pottery wheel) is defined on the basis of the traces left behind on the vessel wall. Generally coarse ware of a varied thickness is assumed to be manufactured on a hand spun pottery wheel, while the use of the fast pottery wheel is indicated by horizontal thin lines

<sup>38</sup> Tudi ta tehnološki postopek pomaga pri izogibanju termičnemu šoku. Pritiski v ostenju posode zaradi temperaturnih razlik so namreč največji ravno v spodnjem delu posode, ki je bil v stiku z ognjem, velika količina dodatkov pa te pritiske zmanjšuje.

<sup>38</sup> This technological procedure can help to avoid thermal shock. Due to the differences in the temperature the pressures within the vessel walls are the highest towards the base, which is in contact with the fire, and a large share of mineral inclusions reduces these pressures.

skupin z določenimi oblikovnimi tipi, pa tudi morebitne zakonitosti pojavljanja teh skupin v določenih časovnih obdobjih ter preveriti, ali je možno razlikovanje med lokalno in regionalno izdelanim posodjem.

Kot je bilo poudarjeno že v uvodu, je oblikovanje tehnoloških skupin pri grobi keramiki na makroskopskem nivoju zaradi značilnosti gradiva dokaj težka naloga. Groba keramika s Tonovcovega gradu po eni strani kaže dokajšnjo tehnološko raznolikost, saj so zastopani različni načini žganja, izdelave in trdote, na drugi strani pa je dokaj enotna. Predvsem velja to za primesi, saj skoraj izključno prevladuje kalcit (glej zgoraj), ki mu je v nekaterih primerih dodana sljuda, zdrobljena opeka ali makroskopsko nedoločljivi (barvni) delci. Pri nekaterih tipih lahko zaradi močne poroznosti domnevamo uporabo organskih snovi. Zastopane so tako oksidacijsko kot redukcijsko žgane posode, pa tudi različne kombinacije (nepopolno redukcijsko žganje, žganje v nekontrolirani atmosferi ...). Tudi pri načinu izdelave je zastopana tako keramika, ki je delana na hitrem vretenu, kot tudi prostoročno izdelani kosi, prevladuje pa na počasnem (ročnem) vretenu delano posodje.

Pri oblikovanju tehnoloških skupin smo od zgoraj naštetih parametrov upoštevali barvo in z njo povezan način žganja, vrsto, velikost in pogostost dodatkov in poroznost. Način izdelave zaradi težav pri opredeljevanju manjših fragmentov ni bil upoštevan.

Zaradi specifičnosti gradiva precej odlomkov ni bilo mogoče uvrstiti. Problematični so bili zlasti majhni odlomki, pa tudi dna posod, pri katerih je bilo zaradi zgoraj opisanih vzrokov težko ugotavljati tako način žganja kot pogostost pridatkov. Taki odlomki so bili uvrščeni v veliko skupino neopredeljenih.

Na ta način se je izoblikovalo 16 tehnoloških skupin (TS), od katerih zadnja (TS 16, neopredeljeno) obsega vse kose, ki jih ni bilo mogoče uvrstiti v prvih 15. Nekatere skupine so še vedno zelo obsežne (predvsem TS 8, 2 in 1), medtem ko so druge bistveno manjše (sl. 4.9).

#### TS 1

Barva: Svetlo rjava, jedro črno.

Način žganja: Redukcijsko, v končni fazi oksidacijsko.

Dodatki: Drogen do fin apnenec, zmerno pogost. Vmes lahko tudi redki grobi delci.

Poroznost: Ni porozna ali drobno porozna.

Tipični predstavnik: Inv. št. 21467 (t. 95: 1).

#### TS 2

Barva: Svetlo rjava ali oranžna, jedro oranžno.

Način žganja: Oksidacijsko.

Dodatki: Drogen ali (redkeje) fin apnenec, zmerno pogost, včasih obilen.

Poroznost: Ne.

Tipični predstavnik: Inv. št. 20351 (t. 74: 2).

and regular shaped grooves (however, these traces can be erased by later smoothening of the surface; Cortese 2005, 330). Thus, we conditionally classified fragments that had no explicit horizontal lines in the interior as manufactured on a slow pottery wheel. Some fragments show traces of various techniques. Some examples show traces of hand making in the lower part, while the upper part reveals traces of horizontal lines typical for the pottery wheel. In such cases we are dealing with a combined manufacturing technique (hand made, with additional working on the pottery wheel).

The previously mentioned parameters were used to form technological groups (TG), the first goal of which was to make it easier to classify the material. In the subsequent steps we tried to find the possible connections between individual technological groups and individual shapes, establish the possible appearance of these groups within certain periods and verify whether it was possible to distinguish between locally and regionally manufactured pottery.

As emphasised in the introduction, the formation of technological groups is a relatively hard task on the macroscopic level. Coarse ware from Tonovcov grad shows relative technological variety, as various types of firing, manufacture and hardness are present, however, on the other hand it is relatively unified. This holds especially true for mineral inclusions, where calcite prevails (see above), and in some cases mica, crushed bricks or macroscopically undefinable (colour) particles were added to it. The strong porosity of some types leads us to believe organic matter was used. We have found reduction and oxidation fired pottery, as well as various combinations (incomplete reduction firing, firing in an uncontrolled atmosphere ...). As regards the type of manufacture we have found pottery manufactured on the fast pottery wheel as well as hand made pieces, however, the most common is pottery manufactured on the slow (hand-spun) pottery wheel.

When forming technological groups we took into account the colour and type of firing associated with it, as well as the type, size and frequency of mineral inclusions and porosity. The type of manufacture was not taken into account due to the problems connected to the classification of the small fragments.

Due to the specifics of the material numerous fragments could not be classified. Especially problematic were small fragments and vessel bases for which it was hard to ascertain the type of firing as well as the frequency of mineral inclusions (see above). These fragments were placed into the large undefined group.

In this process 16 technological groups (TG) were formed, the last of which (TG 16, undefined) comprised of all fragments that could not be categorised into the first 15. Some groups are rather large (especially TG 8, 2 and 1), while others are much smaller (Fig. 4.9).

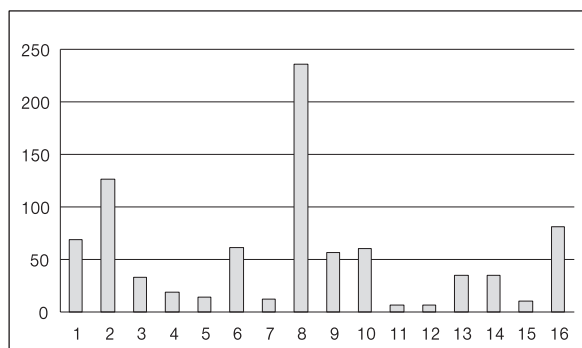

Sl. 4.9: Število diagnostičnih kosov grobe keramike v tehnoloških skupinah.

Fig. 4.9: Number of diagnostic sherds of coarse pottery in technological groups.

#### TS 3

Barva: Svetlo rjava ali oranžna.

Način žganja: Oksidacijsko.

Dodatki: Grob apnenec, zmerno pogost, včasih obilen.

Poroznost: Ne.

Tipični predstavnik: Inv. št. 20881 (*t.* 97: 4)

#### TS 4

Barva: Siva ali črna, jedro črno.

Način žganja: Redukcijsko.

Dodatki: Fin ali droben apnenec, zmerno pogost, včasih obilen; zelo fina sljuda.

Poroznost: Ne.

Tipični predstavnik: Inv. št. 20897 (*t.* 83: 1).

#### TS 5

Barva: Svetlo rjava ali rjava, jedro sivo ali črno.

Način žganja: Redukcijsko, v končni fazi oksidacijsko.

Dodatki: Droben ali fin apnenec, redek ali zmerno pogost; zelo fina, redka sljuda; v nekaterih primerih drobna, redka zdrobljena keramika.

Poroznost: Da, nekateri kosi (v nekaterih primerih imata porozen in neporozen kos stik).

Obdelava površine: Gladek, svetleč premaz.

Tipični predstavnik: Inv. št. 20287 (*t.* 96: 2).

#### TS 6

Barva: Rjava, včasih lisasta, jedro rjavo.

Način žganja: Oksidacijsko.

Dodatki: Fin ali droben apnenec, redek do zmerno pogost.

Poroznost: Ne.

Tipični predstavnik: Inv. št. 20971 (*t.* 82: 7).

#### TS 7:

Barva: Siva.

Način žganja: Redukcijsko.

#### TG 1

Colour: Light brown, the core black.

Firing conditions: Reduced, oxidised in the last phase.

Inclusions: Small to fine calcite, relatively common. Some coarse particles.

Porosity: Not porous or finely porous.

Characteristic example: Inv. No. 21467 (*Pl.* 95: 1).

#### TG 2

Colour: Light brown or orange, the core orange.

Firing conditions: Oxidised.

Inclusions: Small or fine (rarer) calcite, relatively common, sometimes abundant.

Porosity: No.

Characteristic example: Inv. No. 20351 (*Pl.* 74: 2).

#### TG 3

Colour: Light brown or orange.

Firing conditions: Oxidised.

Inclusions: Coarse calcite, relatively common, sometimes abundant.

Porosity: No.

Characteristic example: Inv. No. 20881 (*Pl.* 97: 4)

#### TG 4

Colour: Grey or black, the core black.

Firing conditions: Reduced.

Inclusions: Fine or small calcite, relatively common, sometimes abundant; very fine mica.

Porosity: No.

Characteristic example: Inv. No. 20897 (*Pl.* 83: 1).

#### TG 5

Colour: Light brown or brown, the core grey or black.

Firing conditions: Reduced, in the last phase oxidised.

Inclusions: Small or fine calcite, rare or relatively common; very fine rare mica; in some cases small, rare crushed pottery.

Porosity: Yes, some fragments (in some cases the porous and non-porous fragments are in contact).

Characteristic example: Inv. No. 20287 (*Pl.* 96: 2).

#### TG 6

Colour: Brown, sometimes patchy, brown fracture.

Firing conditions: Oxidised.

Inclusions: Fine or small calcite, rare to relatively frequent.

Porosity: No.

Characteristic example: Inv. No. 20971 (*Pl.* 82: 7).

#### TG 7:

Colour: Grey.

Firing conditions: Reduced.

Dodatki: Droben do grob apnenec, zmerno pogost ali obilen; fina sljuda.

Poroznost: Ne.

Tipični predstavnik: Inv. št. 20303 (*t. 84: 13*).

TS 8:

Barva: Črna ali temno siva.

Način žganja: Redukcijsko.

Dodatki: Fin ali droben apnenec, zmerno pogost ali obilen; včasih grob kremen; včasih zelo fina sljuda.

Poroznost: Ne.

Tipični predstavnik: Inv. št. 20965 (*t. 89: 6*).

TS 9:

Barva: Črna.

Način žganja: Redukcijsko

Dodatki: Fin ali droben apnenec, redek do zmerno pogost, na površini delno izpadel; grobe, zmerno pogoste organske snovi; v nekaterih primerih tudi groba zdrobljena keramika.

Poroznost: Močno porozna.

Tipični predstavnik: inv. št. 21251 (*t. 77: 14*).

TS 10:

Barva: Rjava.

Način žganja: Oksidacijsko ali nekontrolirano.

Dodatki: Fin ali droben apnenec, redek do zmerno pogost; grobe, zmerno pogoste organske snovi.

Poroznost: Močno porozna.

Tipični predstavnik: Inv. št. 21436 (*t. 34: 10*).

TS 11:

Barva: Črna.

Način žganja: Oksidacijsko.

Dodatki: Fin apnenec, zmerno pogost; zelo fina sljuda.

Poroznost: Ne.

Tipični predstavnik: Inv. št. 22054 (*t. 87: 1*).

TS 12:

Barva: Črna ali siva.

Način žganja: Redukcijsko.

Dodatki: Grob do zelo grob, vmes tudi zelo fin apnenec, redek do zmerno pogost.

Poroznost: Ne ali rahlo.

Tipični predstavnik: Inv. št. 22041 (*t. 87: 4*).

TS 13:

Barva: Črna ali siva.

Način žganja: Redukcijsko

Dodatek: Droben do grob apnenec, redek do zmerno pogost; zelo fina sljuda.

Poroznost: Da, nekateri kosi (v nekaterih primerih imata porozen in neporozen kos stik).

Obdelava površine: Gladek, bleščeč premaz.

Tipični predstavnik: Inv. št. 20533 (*t. 97: 8*).

Inclusions: Small to coarse calcite, relatively frequent or abundant; fine mica.

Porosity: No.

Characteristic example: Inv. No. 20303 (*Pl. 84: 13*).

TG 8:

Colour: Black or dark grey.

Firing conditions: Reduced.

Inclusions: Fine or small calcite, relatively frequent or abundant; sometimes coarse quartz; sometimes very fine mica.

Porosity: No.

Characteristic example: Inv. No. 20965 (*Pl. 89: 6*).

TG 9:

Colour: Black.

Firing conditions: Reduced

Inclusions: Fine or small calcite, rare to relatively frequent, in some cases fell out on the surface; relatively frequent coarse organic matter; in some cases also crushed coarse ware.

Porosity: Highly porous.

Characteristic example: Inv. No. 21251 (*Pl. 77: 14*).

TG 10:

Colour: Brown.

Firing conditions: Oxidised or uncontrolled.

Inclusions: Fine or small calcite, rare to relatively frequent; relatively frequent coarse organic matter.

Porosity: Highly porous.

Characteristic example: Inv. No. 21436 (*Pl. 34: 10*).

TG 11:

Colour: Black.

Firing conditions: Oxidised.

Inclusions: Fine calcite, relatively frequent; very fine mica.

Porosity: No.

Characteristic example: Inv. No. 22054 (*Pl. 87: 1*).

TG 12:

Colour: Black or grey.

Firing conditions: Reduced.

Inclusions: coarse to very coarse, in between very fine calcite, rare to relatively frequent.

Porosity: No or slightly.

Characteristic example: Inv. No. 22041 (*Pl. 87: 4*).

TG 13:

Colour: Black or grey.

Firing conditions: Reduced

Inclusions: Small to coarse calcite, rare to relatively frequent; very fine mica.

Porosity: yes, some fragments (in some cases the porous and non-porous fragment are in contact).

Characteristic example: Inv. No. 20533 (*Pl. 97: 8*).

TS 14:

Barva: Črna.

Način žganja: Redukcijsko ali nepopolno redukcijsko.

Dodatek: Droben do grob apnenec, obilen.

Poroznost: Ne.

Tipični predstavnik: Inv. št. 21805 (*t.* 99: 2).

TS 15:

Barva: Rjava ali črna in rjava lisasta.

Način žganja: Oksidacijsko ali nekontrolirano.

Dodatek: Droben do grob apnenec, zmerno pogost, zelo fina sljuda, zmerno pogosta.

Poroznost: Ne.

Tipični predstavnik: Inv. št. 20818 (*t.* 79: 3).

TS 16: neopredeljeno

V to skupino so uvrščeni vsi primeri, ki jih nismo mogli uvrstiti v katero od zgoraj opisanih skupin – bodisi zato, ker je bil obravnavan kos premajhen, da bi se dalo točno določiti tehnološke značilnosti, bodisi zato, ker so bile na enem kosu izražene značilnosti različnih tehnoloških skupin.

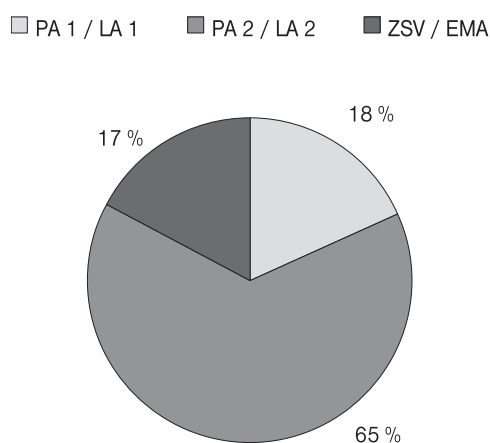

Sl. 4.10: Zastopanost grobe keramike po fazah glede na število značilnih kosov.

Fig. 4. 10: Representation of coarse ware per individual phases according to the number of diagnostic sherds.

Kot je bilo že uvodoma poudarjeno, gre za razdelitev, ki temelji samo na makroskopskih opažanjih, zato postavitev skupin nikakor ni dokončna. Nekatere velike skupine (npr. TS 1, 2 in 8) bi bilo verjetno potrebno še razdeliti, vendar z makroskopskim opazovanjem ni bilo mogoče zanesljivo določiti razločevalnih kriterijev, ki bi tako razdelitev opravičevali.

Nekatere skupine kažejo precejšnjo sorodnost v večini kriterijev, se pa med seboj močno razlikujejo v enem ali dveh. Izrazit tak primer sta TS 9 in 10. V obeh primerih gre za zelo porozno, lahko keramiko (verjetno

TG 14:

Colour: Black

Firing conditions: Reduced or incompletely reduced.

Inclusions: small to coarse calcite, abundant.

Porosity: no.

Characteristic example: Inv. No. 21805 (*Pl.* 99: 2).

TG 15:

Colour: Brown or black or patchy brown.

Firing aconditions: Oxidised or non-controlled.

Inclusions: small to coarse calcite, relatively frequent, very fine mica, relatively frequent.

Porosity: No.

Characteristic example: Inv. No. 20818 (*Pl.* 79: 3).

TG 16: undefined

This group includes all examples that could not be placed into any other group – whether this was because the analysed fragment was too small to precisely define the technological characteristics, or because a single fragment had characteristics belonging to multiple technological groups.

As emphasised in the introduction, this classification is based on macroscopic observations, thus the groups are by no means final. Some large groups (e.g. TG 1, 2 and 8) would probably have to be divided into further subgroups; however it was impossible to reliably define the separation criteria that would justify such classification merely by macroscopic observations.

Some groups show relative similarity in most criteria, but differ strongly in one or two. A strong example of this are TG 9 and 10. Both are very porous pottery fabrics (most likely organic matter was added, however this disappeared during the firing process), which could be reduced (TG 9) or uncontrolled or oxidised fired (TG 10).

Also problematic is the large group of undefined fragments, in which the examples that show characteristics of various firing processes were categorised.

Our doubts were confirmed by the mineralogical analysis of selected examples from individual technological groups, which resulted in the formation of four mineralogical groups (TG A-TG D, with subgroups D1, D2 and D3; see chapter 10). At this it was ascertained that some macroscopically defined technological groups correspond to mineralogical groups (TG 2 = TG D1; TG 3 = TG D3; TG 13 = TG A) and others do not. Some samples that were placed into different technological groups had an identical mineral composition (TG 5, 8 = TG D 2). On the other hand, some samples that were placed into the same technological group could differ as regards their mineral composition (TG 6, = TG B, TG D2, TG D3; TG 9 = TG B, TG D2; TG 10 = TG B, TG C; see chapter 10.4, *Tab.* 10.2).

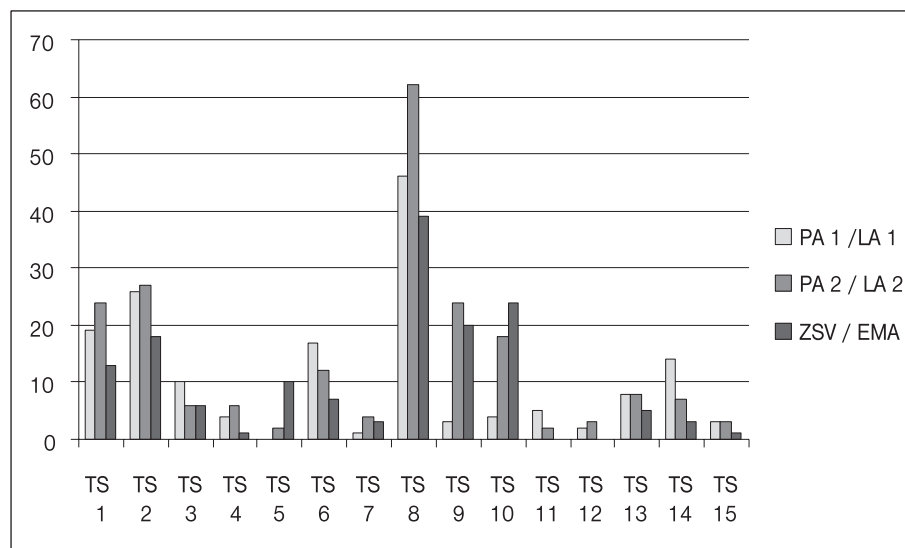

Sl. 4.11: Zastopanost tehnoloških skupin (TS) po fazah.

Fig. 4.11: Representation of technological groups (TG) per individual phase.

so ji bile dodane tudi organske primesi, ki so izpadle v procesu žganja), ki pa je lahko žgana redukcijsko (TS 9) ali pa nekontrolirano oziroma nepopolno oksidacijsko (TS 10).

Prav tako je problematična velika skupina neopredeljenih, kamor so bili uvrščeni vsi primeri, ki so kazali značilnosti različnih načinov žganja.

Vse te dvome je potrdila tudi mineraloška analiza izbranih primerov iz posameznih tehnoloških skupin, pri kateri so se oblikovale štiri mineraloške skupine (TG A–TG D, s podskupinami D1, D2 in D3; glej pogl. 10). Pri tem je bilo ugotovljeno, da nekatere makroskopsko določene tehnološke skupine ustrezajo mineraloškim skupinam (TS 2 = TG D1; TS 3 = TG D3; TS 13 = TG A), druge pa ne. Nekateri vzorci, uvrščeni v različne tehnološke skupine, so bili mineraloško identični (TS 5, 8 = TG D2). Po drugi strani so bili nekateri vzorci, uvrščeni v isto tehnološko skupino, mineraloško različni (TS 6 = TG B, TG D2, TG D3; TS 9 = TG B, TG D2; TS 10 = TG B, TG C; glej pogl. 10.4, tab. 10.2).

Analiza zastopanosti tehnoloških skupin po posameznih časovnih fazah, ki je bila izvedena pred rezultati mineraloške analize, je pokazala, da je večina tehnoloških skupin zastopana v vseh fazah, opazna pa je večja priljubljenost nekaterih skupin v posameznih fazah (sl. 4.11). Pri interpretaciji rezultatov je treba upoštevati dejstvo, da je najdb keramike iz prve poznoantične faze in iz zgodnjerednjeveške faze bistveno manj kot iz druge poznoantične (sl. 4.10), kljub temu pa razmerja kažejo relativno visoko stopnjo kontinuitete med fazami. To je potrdila tudi mineraloška analiza, saj je npr. najpogostejši tip (TG D2) približno enakomerno zastopan v vseh fazah (glej pogl. 10.4, tab. 10.2).

The analysis of the dispersion of technological groups within individual periods, which took place prior to the mineralogical analysis, has shown that most technological groups were represented in all phases, but certain groups were more popular in individual phases (Fig. 4.11). By the interpretation of the results it is necessary to take into account that there are significantly less pottery finds from Late Antiquity 1 or the Early Medieval phase than those from Late Antiquity 2 (Fig. 4.10), however the ratios show a relatively high level of continuity between the phases. The mineralogical analysis confirmed this result, for the most common type (TG D2) was approximately equally represented in all phases (see chapter 10.4, Tab. 10.2).

TG 6, 11 and 14 dominate in Late Antiquity 1 layers, while the rare examples of these groups in Late Antiquity 2 and Early Medieval layers can be considered residual finds (Fig. 4.11).

Some groups prevail in Early Medieval layers (TG 5, to a certain extent TG 9 and 10) and are rare in Late Antiquity 1 layers.

Some technological groups show a connection with certain form types (see chapter 4.2.2). Thus, bowls type 5b were manufactured exclusively in TG 6 and the similar TG 2. Pots type 7 are almost exclusively linked to TG 5, 9 and 10. In some groups we have not noticed any characteristics that would be linked to the form types. These are mainly large groups and this could indicate that they should be subdivided into smaller groups.



TS 6, 11 in 14 prevladujejo v plasteh prve poznoantične faze, nekatere redke primere teh skupin v plasteh druge poznoantične faze in v zgodnesrednjeveških plasteh pa lahko štejemo za rezidualne kose (sl. 4.11).

Nekatere skupine prevladujejo v zgodnesrednjeveških plasteh (TS 5, delno TS 9 in 10), medtem ko jih v plasteh prve poznoantične faze ni ali pa so redke.

Nekatere tehnološke skupine kažejo tudi povezavo z določenimi oblikovnimi tipi posod (glej tudi poglavje 4.2.2). Tako so sklede tipa 5b izdelane izključno v TS 6 in njej sorodni TS 2. Ravno tako se lonci tipa 7 izrazito povezujejo s TS 5, 9 in 10. Obstajajo pa tudi skupine, pri katerih nismo opazili nobenih zakonitosti v povezavi z oblikovnimi tipi. Tudi to so predvsem večje skupine, kar morda ponovno kaže, da bi jih bilo potrebno razdeliti še na manjše.

#### 4.2.2 OBLIKOVNA ANALIZA

Kot je bilo prikazano zgoraj, na območju jugovzhodnih Alp že obstajajo nekatere delitve grobe poznoantične keramike na oblikovne tipe (Invillino: Bierbrauer 1987; Sv. Hema: Ladstätter 2000; Tinje: Ciglencečki 2000), opazni so tudi poskusi izogibanja delitvi tovrstnega gradiva na klasične tipološke načine (Castelraimondo: Santoro Bianchi 1995). Kljub temu je tudi v delih, ki se ne poslužujejo klasične tipologije, potrebno urejanje in grupiranje materiala. Tako se pojavljajo poskusi oblikovanja skupin s kombinacijo tehnoloških in oblikovnih parametrov (Massa, Portulano 1999; Cortese 2005). Večinoma se uporabljajo delitve po osnovnih oblikah (npr. sklede, skodele, pokrovi, ponve, lonci, kozice, vrči ...), vendar je za tovrstno delitev potrebna relativno dobra ohranjenost posod, saj šele določljivi proporci omogočajo osnovno razdelitev npr. med lonci, lončki in čašami, med pladnji in krožniki, med skledami in skodelami.

Pri obravnavani keramiki s Tonovcovega gradu teh proporcev večinoma ni bilo mogoče določiti. Rekonstruirati je bilo večinoma mogoče samo premer ustja posod, včasih je ohranjen tudi prehod ustja v ostenje ter del ostenja. Klasifikacijo otežuje tudi nestandardizirana proizvodnja, katere posledica je množica različnih oblik in dimenzij posod.

Zato smo se odločili za delitev gradiva po obliki zgornjega dela posode, to je ustja, vratu in prehoda ustja v rame. Ker gre pri grobi keramiki za zelo lokalno občutljiv produkt, je bila postavljena lastna tipološka shema. Prevzemanje že izdelanih tipologij s sorodnih najdišč se ni zdelo smiselno (nekaterih na teh najdiščih definiranih tipov namreč na Tonovcovem gradu sploh ni, se pa tu pojavljajo tipi, ki jih ni na drugih najdiščih), uporabljeni pa so bili kot pomoč pri izdelavi lastne tipologije.

Na Tonovcovem gradu je zastopano posodje zaprtih in odprtih oblik. Med posodje zaprtih oblik uvrščamo

#### 4.2.2 FORM ANALYSIS

As shown above, in the Southeastern Alps some divisions of the Late Antique coarse pottery into form types already exist (Invillino: Bierbrauer 1987; Hemmaberg: Ladstätter 2000; Tinje: Ciglencečki 2000), and we can also notice certain attempts of avoiding the division of pottery into classical form types (Castelraimondo: Santoro Bianchi 1995). However, even in works that do not use classical form type-series the material needs to be grouped and sorted. Thus attempts have been noticed to form groups with a combination of technological and shape parameters (Massa, Portulano 1999; Cortese 2005). Mostly divisions according to the basic forms (e.g. bowls, cups, lids, pans, pots, jugs ...) were used. However, the pottery needs to be relatively well preserved if one wishes to divide it according to its use, for only proportions that can be defined enable a basic division into pots and jugs, platters and plates, bowls and cups.

On Tonovcov grad these proportions mostly could not be defined. In most cases only the diameter of the vessel rim could be reconstructed, and sometimes the transition between the rim and the vessel body and a part of the body was preserved. The classification was made harder by the non-standardised production, the result of which is an assortment of various pottery shapes and dimensions.

Due to this we decided to categorise the discovered pottery according to the upper part of the vessel, i.e. the rim, neck and the transition between the rim and the shoulder. As coarse ware is a typically local product we set up our own typological scheme. Adopting existing schemes from similar sites did not seem to make sense (some of the types found at these sites were not present at Tonovcov grad and on the other hand types that were not found at other sites have been discovered at Tonovcov grad), however they were used as a form of help in the production of our own typology.

Open and closed pottery types were discovered at Tonovcov grad. Pots and jugs (defined on the basis of the preserved handle or several handles) belong amongst the closed types, while bowls, lids, plates, platters, lids and fire covers are considered to be open types.

Among the closed forms only pots were typologically classified, for there were so few jugs we did not split them into different categories. The pot typology was concluded on the base of the shape, length and inclination of the rim and the transition between the rim and the body. As our samples are extremely fragmented, the shape of the body, its largest diameter and height were not considered in the typology. This could not have been defined for most of the pots found at Tonovcov grad. 8 pot types were established. Individual types could be further divided into subtypes according to the rim endings.

Bowls were the most common open vessels. These were followed by lids, but as it is often impossible to

lonce in vrče (definirane na podlagi ohranjenega ročaja ali več ročajev), med odprte pa sklede, pokrove in pekve ter krožnike ali pladnje.

Med zaprtimi oblikami so bili tipološko razvrščeni le lonci, medtem ko vrčkov zaradi njihove maloštevilnosti nismo posebej ločevali. Tipologija loncev je narejena na podlagi oblike, dolžine in naklona ustja in prehoda ustja v ostenje. Ker gre za zelo fragmentarno ohranjene primere, pri tipološki delitvi ni bila upoštevana oblika trebuha, mesto največjega premera posode in njena višina. Pri večini loncev s Tonovcovega gradu tovrstna določitev namreč ni bila mogoča. Tako se je pri loncih izoblikovalo 8 tipov. Posamezni tipi so bili glede na načine zaključka ustja lahko razdeljeni še na variante.

Med odprtimi oblikami so bile najpogostejše sklede. Sledijo jim pokrovi, ker pa je le redko mogoče zanesljivo razlikovati med skledami z ravnim ostenjem ter pokrovi in pekvami, so bili vsi nezanesljivi primeri uvrščeni med sklede. Pri nekaterih oblikah lahko predvidevamo tudi dvojno uporabo glede na potrebe – kot skledo ali kot pokrov oziroma pekvo. Tudi pri skledah je bila za uvrstitev v posamezni tip odločilna oblikovanost zgornjega dela posode, to je nagnjenost ustja oziroma zgornjega dela od sredinske osi, oblikovanosti ostenja (npr. konično, kroglasto) ter premer ustja. Pri skledah se je tako izoblikovalo 10 tipov, znotraj katerih je bila pri nekaterih opravljena še delitev na variante glede na zaključek ustja ali glede na velikost.

Krožnikov in pokrovov zaradi maloštevilnosti in precejšnje oblikovne enotnosti nismo tipološko delili.

Tako postavljenim oblikovnim tipom smo poiskali analogije najprej v zahodni Sloveniji in vzhodni Furlaniji, potem pa še širše na jugovzhodnoalpskem in severnojadranskem prostoru. Pri tem dejstvo, da ima določen tip analogijo na nekem drugem najdišču, še ne pomeni neposredne časovne povezave, saj posebno pri grobi keramiki pripisovanju kronoloških vrednost morebitnim formalnim podobnostim lahko pripelje do napačnih zaključkov. Posebno nekatere bolj enostavne oblike (lonci tipov 1, 2, 6, 7; sklede tipa 1) se lahko na obravnavanem območju pojavljajo med gradivom poznorimskega, poznoantičnega in zgodnjerednjeveškega obdobja. Pojavljanje podobnih oblik na različnih območjih v različnih obdobjih smo skušali ovrednotiti v sklepu tega poglavja.

Vsak tip je postavljen tudi v stratigrafske kontekste na Tonovcovem gradu. Pri tem se je izkazalo, da gre pri večini tipov za oblike, ki se pojavljajo v vseh časovnih obdobjih, medtem ko so bili drugi časovno dokaj ozko omejeni (sl. 4.12). Tudi komentar o tem sledi v sklepu.

Poleg tega smo poskušali povezati določene oblikovne tipe s tehnološkimi skupinami. Izkazalo se je, da so bili nekateri tipi povezani le z nekaterimi tehnološkimi skupinami, medtem ko drugi kažejo širok razpon različnih tehnoloških skupin.

distinguish between bowls with a straight wall, lids and fire covers, all examples that could not be reliably classified were categorised as bowls. We can assume that some forms had a double use, depending on the needs – as a bowl or as a lid or a fire cover. Bowls were classified into individual types according to the shape of the upper part, i.e. the inclination of the rim or the upper part from the central axis, the body shape (e.g. conical, rounded) and the rim diameter. In this way we were able to differentiate between 10 bowl types. Some types were further subdivided according to the rim ending or size.

Due to their rarity and relative shape unity we did not typologically divide plates and lids.

We searched for analogies for these shape types, first in western Slovenia and eastern Friuli and then broader in the Southeastern Alps and the northern Adriatic. The fact that a certain type has an analogy at some other site does not necessarily mean that they were from the same period, for especially at coarse ware ascribing a chronological value to the possible formal similarities can lead to wrongful conclusions. Especially some simple forms (pots types 1, 2, 6, 7; bowls type 1) can appear amongst the material belonging to the Late Roman, Late Antique or Early Medieval periods in the discussed area. At the end of this chapter we attempted to evaluate the appearance of similar forms in various areas and during various periods.

Every type was also placed into the stratigraphic context at Tonovcov grad. It was discovered that most types and shapes appeared in all periods, while some appeared only within a very narrow time frame (Fig. 4.12). Commentary on this can be found in the conclusion.

We also tried to link shape types to technological groups. It was discovered that certain types were linked only to certain technological groups, while others were linked to a wide variety of different technological groups.

## BOWLS

**Type 1** (Pls. 74-76; 102: 1; 103: 2).

*Form:* Type 1 includes bowls with a conical or a very slightly curved wall which transforms directly into the rim. This is a very common type at Tonovcov grad. We can distinguish between three rim variants:

1a: The rim is cut off in a straight line and is not thickened (Pls. 74: 1-10; 76: 5-8; 102: 1).

1b: The rim is semi-circularly ended (Pls. 75: 1-10; 76: 9-10; 103: 2).

1c: The rim is thickened or pulled out on the outer side (Pl. 76: 1-4, 11-17).

*Size:* This category consists of small and medium (diameter of 15-20 cm, with a wall approx. 3-5 mm thick), as well as very large sized bowls (diameter measuring between 25-33 cm, wall thickness 7-10 mm). Subgroup 1a mainly includes small and medium sized bowls, sub-

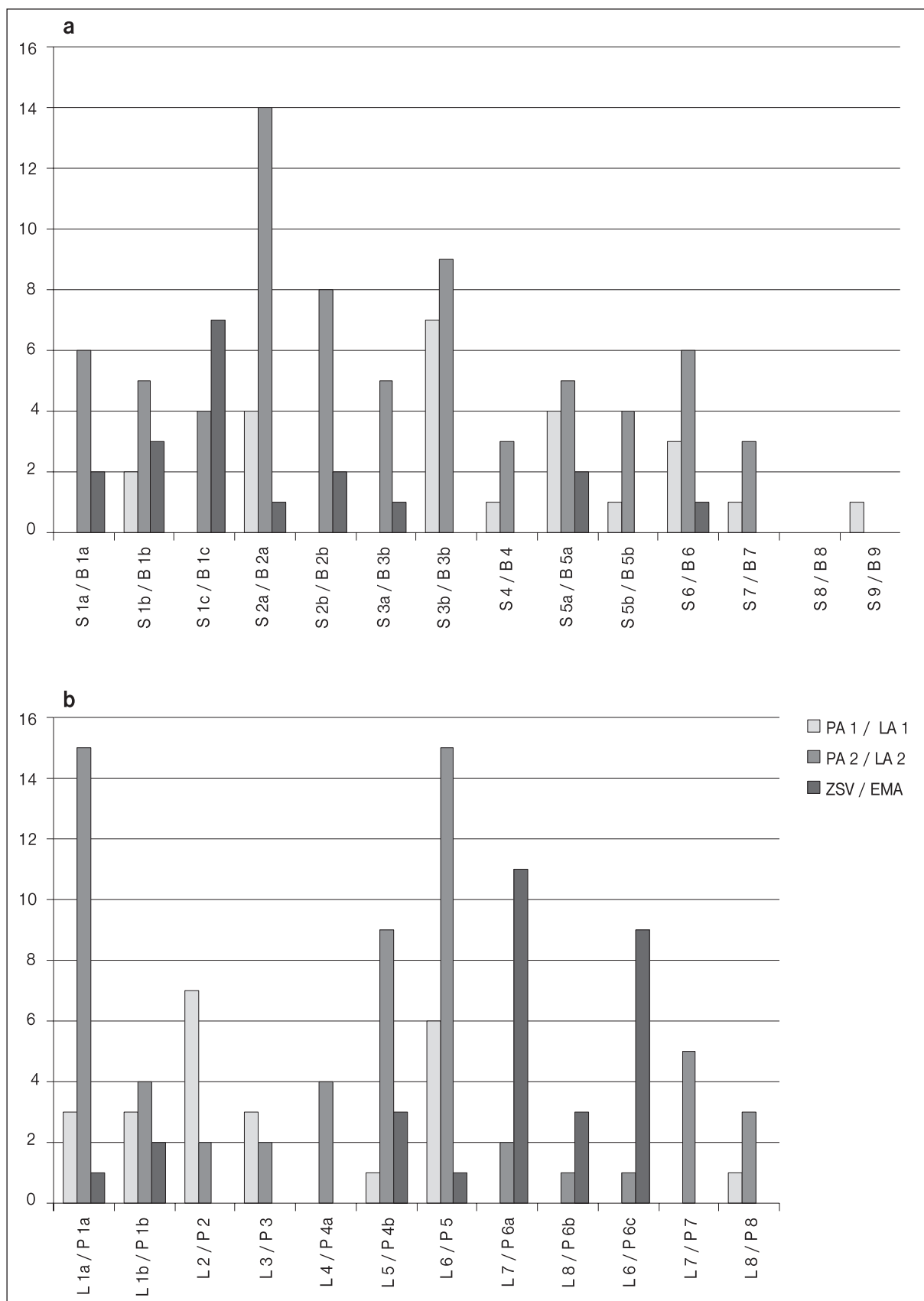

Sl. 4.12: Zastopanost tipov skled (a) in loncev (b) po fazah.

Fig. 4.12: Representation of types of bowls (a) and pots (b) per individual phase.

## SKLEDE

**Tip 1** (t. 74–76; 102: 1; 103: 2)

*Oblika:* V tip 1 so združene sklede s koničnim ali zelo rahlo usločenim ostenjem, ki prehaja neposredno v ustje. Tip sodi med najbolj številčne na Tonovcovem gradu. Ločimo lahko 3 variante ustja:

1a: Ustje je lahko ravno odrezano in neodebeljeno (t. 74: 1–10; 76: 5–8; 102: 1).

1b: Ustje je polkrožno zaključeno (t. 75: 1–10; 76: 9–10; 103: 2).

1c: Ustje je odebeljeno ali na zunanji strani izvlčeno (t. 76: 1–4, 11–17).

*Velikost:* Pojavljajo se tako majhne do srednje velike sklede (premera 15–20 cm, z ostenjem debelim okr. 3–5 mm), kot tudi zelo velike (premer 25–33 cm, debelina ostenja 7–10 mm). Majhne in srednje velike sklede pripadajo večinoma varianti 1a, pri varianti 1b se pojavljajo majhne in velike, v varianto 1c pa sodijo večinoma zelo velike sklede. Pri večjih lahko domnevamo tudi njihovo uporabo kot pekve, saj je ločitev med skledami in pekvami zaradi oblikovne podobnosti težka.<sup>39</sup>

*Izdelava:* Sklede variante 1a so bile večinoma izdelane iz kvalitetne glin, trdo redukcijsko ali oksidacijsko žgane (TS 2, 8). Med skledami variante 1b prevladujejo oksidacijsko žgane sklede, izdelane v tehnoloških skupinah 1 in 6.<sup>40</sup> Pri skledah tipa 1c ni opaziti nobene zakonitosti, zastopane so tehnološke skupine 1, 2, 5, 9 in 10.

*Okras:* Pri skledah variant 1a in 1b se pojavlja fino metličenje (t. 75: 3,8–9; 76: 8), lahko v kombinaciji z valovnico (t. 74: 2,8), samostojne valovnice (t. 74: 6,9; 75: 4–5; 76: 7; 102: 1; 103: 2), žlebljenje (t. 74: 3,7), nekaj skled je tudi neokrašenih. Pri varianti 1c prevladuje fino metličenje po celi površini posode (t. 76: 1,3–4, 11–12, 14–15), ki je večinoma obojestransko. Valovnica pri vseh variantah je izključno enojna, včasih je lahko kombinirana z žlebljenjem (t. 74: 6; 75: 5; 76: 19). V nekaj primerih je izvedena precej nepravilno (t. 74: 9; 75: 4–5; 102: 1).

*Lega:* Večina skled tega tipa je ležala v plasteh druge poznoantične in zgodnjersrednjeveške faze (sl. 4.12). Edina izjema sta skledi t. 75: 6,9, ki sta bili najdeni pod hodno površino stavbe 1 v prvi poznoantični fazi in se tudi po fakturi razlikujeta od večine ostalih. Sklede tipa 1c pa se pojavljajo izključno v plasteh druge poznoantične faze in v zgodnjersrednjeveških plasteh.

*Analogije:* Varianta 1a je pogosta na celem jugovzhodnoalpskem območju. Na Invillinu ustreza posodam tipov I a3, I c in delno I f (Bierbrauer 1987, t. 70: 1,3,5,13;

group 1b mainly small and large bowls, while most of subgroup 1c is represented by very large bowls. We can assume that the larger ones were also used as a fire covers, for it is hard to differentiate between bowls and fire covers due to their similar shapes.<sup>39</sup>

*Manufacture:* Most type 1a bowls were produced from high quality clay, hard reduced or oxidised fired (TG 2, 8). Most type 1b bowls were oxidised fired, made in technological groups 1 and 6.<sup>40</sup> No special characteristics could be defined for type 1c bowls, technological groups 1, 2, 5, 9 and 10 are represented.

*Decoration:* Fine brush strokes appear on type 1a and 1b bowls (Pls. 75: 3,8–9; 76: 8), sometimes in combination with multiple wavy lines (Pl. 74: 2,8), individual wavy lines (Pls. 74: 6,9; 75: 4–5; 76: 7; 102: 1; 103: 2) or grooves (Pl. 74: 3,7); some bowls were not decorated. In type 1c fine brush strokes appear across the entire vessel surface (Pls. 76: 1,3–4, 11–12, 14–15), in most cases on inner and outer side of a bowl. All examples have a single wavy line, sometimes combined with grooves (Pls. 74: 6; 75: 5; 76: 19). Some of the examples seem to be made in an irregular fashion (Pls. 74: 9; 75: 4–5; 102: 1).

*Position:* Most bowls belonging to this type were discovered in Late Antiquity 2 or Early Medieval layers (Fig. 4.12). The only exception are the two bowls Pl. 75: 6,9 that were discovered in the Late Antiquity 1 layer, under the floor level of building 1, and which differ from the others also in their fabric. Bowls type 1c appear exclusively in Late Antiquity 2 and Early Medieval layers.

*Analogies:* Type 1a is common throughout the South-eastern Alps. At Invillino it corresponds to vessels type I a3, I c and partially I f (Bierbrauer 1987, Pls. 70: 1,3,5,13; 81: 13; 84: 13,15,17; 97: 14–15; 99: 22; 113: 10; 129: 7; 131: 7–10). They were discovered also on Ajdna (Ciglencečki 2000, Fig. 124: 1), Ajdovščina above Rodik (Ciglencečki 2000, Fig. 116: 1–2; Vidrih Perko 1997a, Pl. 2: 21 – as a fire cover), in Koper (Cunja 1996, Pls. 37: 392; 38: 398–401 – as a fire cover), on Križna gora (Ciglencečki 2000, Fig. 108: 3,8–11), Gradec near Prapretno (Ciglencečki 1981, Pl. 4: 41), Tinje (Ciglencečki 2000, Pls. 26: 5; 30: 9–11 – as lids), Kuzelin (Sokol 1994, Pl. 4: 10), Kučar (J. Dular, Ciglencečki, A. Dular 1995, Pls. 82: 10; 83: 4), Duel (Steinklauber 1990, Figs. 19–21, 26), at Teurnia (Rodriguez 1997, Pl. 4: 32,36), Kappele (Felgenhauer-Schmiedt 1993, Pls. 10: 9; 23: 30; 28: 11, 32: 4–5), Ulrichsberg (Rodriguez 1997, Pl. 12: 112) and Hemmaberg (type 1, Ladstätter 2000, 143–144; Pl. 14: 5–7).

Type 1b has a partial analogy at Invillino in type Ia (Bierbrauer 1987, Pl. 129: 7–8). Within Friuli analogies were also found at Castelraimondo (Covizzi 1995, Pl. 14:

<sup>39</sup> V Koprju so posode take oblike na podlagi jezičastih držajev in odprtih na ostenju opredeljene kot pekve (Cunja 1996, 128).

<sup>40</sup> Podobno na Invillinu med manjšimi skledami prevladujejo sive in črne, redukcijsko žgane, trde, medtem ko so velike sklede večinoma svetlo rjave, oksidacijsko, mehko žgane (Bierbrauer 1987, 191–192).

<sup>39</sup> In Koper vessels of this shape were defined as fire covers due to their tongue shaped handles and the openings in the walls (Cunja 1996, 128).

<sup>40</sup> Similarly at Invillino amongst the smaller bowls grey and black, reduced fired, hard ones dominate, while amongst the large bowls most are light brown, oxidised fired and soft (Bierbrauer 1987, 191–192).

81: 13; 84: 13,15,17; 97: 14–15; 99: 22; 113: 10; 129: 7; 131: 7–10). Najdene so bile tudi na Ajdnu (Ciglenečki 2000, sl. 124: 1), Ajdovščini nad Rodikom (Ciglenečki 2000, sl. 116: 1–2; Vidrih Perko 1997a, t. 2: 21 – kot pekva), v Kopru (Cunja 1996, t. 37: 392; 38: 398–401 – kot pekve), na Križni gori (Ciglenečki 2000, sl. 108: 3,8–11), Gradcu pri Prapretnem (Ciglenečki 1981, t. 4: 41), Tinju (Ciglenečki 2000, t. 26: 5; 30: 9–11 – kot pokrovi), Kuzelinu (Sokol 1994, t. 4: 10), Kučarju (J. Dular, Ciglenečki, A. Dular 1995, t. 82: 10; 83: 4), Duelu (Steinklauber 1990, sl. 19–21, 26), v Teurniji (Rodriguez 1997, t. 4: 32,36), na Kappeli (Felgenhauer-Schmiedt 1993, t. 10: 9; 23: 30; 28: 11; 32: 4,5), Šenturški gori (Rodriguez 1997, t. 12: 112) in Sv. Hemi (tip 1, Ladstätter 2000, 143–144; t. 14: 5–7).

Varianta 1b delno ustreza oblika Invillino I a (Bierbrauer 1987, t. 129: 7–8). V Furlaniji so bile najdene še na Castelraimundu (Covizzi 1995, t. 14: C 6212). Ta varianta je pogosta tudi v osrednji Sloveniji in na avstrijskem Koroškem: Gradec pri Prapretnem (Ciglenečki 2000, sl. 1: 3), Tinje (Ciglenečki 2000, t. 26: 7), Kappele (Ciglenečki 2000, sl. 136: 7), Šenturška gora (Rodriguez 1997, t. 6: 58; 12: 113), Sv. Hema (tip 2, Ladstätter 2000, 144, t. 15: 1–3).

Varianta 1c se pojavlja na Invillinu (Bierbrauer 1987, t. 72: 3; 132: 9), Castelraimundu (Covizzi 1995, t. 9: C 2423), v Coseanu (Rupel 1988, št. 83–84), Kopru (Cunja 1996, t. 37: 391), Akvileji (Rupel 1994, CCg 94–96). Na vzhodnejše ležečih naselbinah je redka (npr. Tinje: Ciglenečki 2000, t. 30: 12 – kot pekva).

Za vse oblike tipa 1, posebno pa za varianto 1c, velja, da pogosteje nastopajo na zahodnem delu obravnavanega prostora.

**Daticija:** Glede na stratigrafski položaj lahko sklede tipa 1 (variante 1b) na Tonovcovem gradu postavimo že v čas prve poznoantične faze, vendar so v teh plasteh redke. Največ skled tipa 1 vseh variant je bilo najdenih v plasteh druge poznoantične faze (sl. 4.12), zato lahko sklepamo, da je 6. st. čas njihove največje priljubljenosti. Na Castelraimundu so sklede 1b sicer okvirno datirane v 4. in začetek 5. st. (Covizzi 1995, t. 9: C 2423), na Sv. Hemi pa so tudi značilne za plasti druge polovice 6. st. (Ladstätter 2000, 144).

Sklede variante 1c se na Tonovcovem gradu pojavljajo že v drugi poznoantični fazi, v uporabi pa ostanejo tudi še v zgodnj srednjeveškem obdobju. Podobno je na Invillinu, kjer so sklede tipa Invillino Ia 3 značilne za fazo III, pojavljajo pa se še v zgodnj srednjeveškem obdobju (Bierbrauer 1987, 208). Na Sv. Hemi so datirane v drugo polovico 6. st., najmlajše oblike (z obojestransko razširjenim ustjem, okrašenim s punktiranjem) pa segajo še v prvo polovico 7. st. (Ladstätter 2000, 143).

**Tip 2** (t. 77; 78; 79: 1–8; 102: 2; 103: 5–6; 104: 10; 105: 1–2)

**Oblika:** Gre za sklede s polkrožno oblikovanim ostenjem in neodebeljenim ustjem, ki je lahko na notra-

C 6212). This type is common also in central Slovenia and in Austrian Carinthia: Gradec near Prapretno (Ciglenečki 2000, Fig. 1: 3), Tinje (Ciglenečki 2000, Pl. 26: 7), Kappele (Ciglenečki 2000, Fig. 136: 7), Ulrichsberg (Rodriguez 1997, Pls. 6: 58; 12: 113), Hemmaberg (type 2, Ladstätter 2000, 144, Pl. 15: 1–3).

Type 1c appears at Invillino (Bierbrauer 1987, Pls. 72: 3; 132: 9), Castelraimondo (Covizzi 1995, Pl. 9: C 2423), Coseano (Rupel 1988, Nos. 83–84), Koper (Cunja 1996, Pl. 37: 391) and Aquileia (Rupel 1994, CCg 94–96). It is rarely found in settlements further east (e.g. Tinje: Ciglenečki 2000, Pl. 30: 12 – as a fire cover).

All variants of type 1, especially variant 1c, are most commonly found in the western part of the discussed area.

**Date:** Taking into account the stratigraphic position bowls type 1 (variant 1b) can be dated as early as Late Antiquity phase 1 (at Tonovcov grad); however in this period they were rare. Most type 1 bowls (all subtypes) were discovered in Late Antiquity 2 layers (Fig. 4.12), thus we can conclude that they were most popular in the 6<sup>th</sup> century. At Castelraimondo bowls 1b were roughly dated into the 4<sup>th</sup> and beginning of the 5<sup>th</sup> century (Covizzi 1995, Pl. 9: C 2423), while on Hemmaberg they were characteristic of layers dated into the second half of the 6<sup>th</sup> century (Ladstätter 2000, 144).

On Tonovcov grad bowls type 1c appeared already in the Late Antiquity 2 phase, and they remained in use in the Early Medieval period. Similar holds true for Invillino, where bowls type Invillino Ia3 were characteristic of phase III, but they also appeared in the Early Medieval period (Bierbrauer 1987, 208). At Hemmaberg they were dated into the second half of the 6<sup>th</sup> century, while the most recent forms (with the rim broadened on both sides, decorated with punctures) reached into the first half of the 7<sup>th</sup> century (Ladstätter 2000, 143).

**Type 2** (Pls. 77; 78; 79: 1–8; 102: 2; 103: 5–6; 104: 10; 105: 1–2)

**Form:** These bowls have a semi-circular wall and a non-thickened rim that can be grooved on the inner edge. Shapes with only slightly curved wall are very similar to bowls type 1 (e.g. Pls. 77: 7; 78: 1). The rim edge can be semi-circular (variant 2a, Pls. 77: 1–15; 78: 1–10; 102: 2; 103: 5–6; 104: 10; 106: 10) or cut off in a straight line (variant 2b, Pls. 78: 11–16; 79: 1–8; 105: 2).

**Size:** According to the size two groups were recognised, i.e. small bowls with a diameter measuring between 12 and 16 cm, and medium sized bowls with a diameter measuring between 18 and 20 cm. There were no truly large bowls with a diameter measuring more than 20 cm.

**Manufacture:** Roughly the same share of bowls was reduced or oxidised fired. We have found quality fired bowls, made in TG 2, 8 and 11, as well as coarse, porous bowls (TG 9, 10).

njem robu nažlebljeno. Oblike, ki imajo ostenje usločeno bolj rahlo, se približujejo skledam tipa 1 (npr. *t.* 77: 7; 78: 1). Rob ustja je lahko polkrožen (varianta 2a, *t.* 77: 1–15; 78: 1–10; 102: 2; 103: 5–6; 104: 10; 106: 10) ali ravno odrezan (varianta 2b, *t.* 78: 11–16; 79: 1–8; 105: 2).

*Velikost:* Glede na velikost se oblikujeta dve skupini, in sicer majhne sklede premera med 12 in 16 cm, ter srednje velike sklede premera med 18 in 20 cm. Izrazito velikih skled s premerom nad 20 cm ni.

*Izdelava:* Približno enako število skled je žganih redukcijsko in oksidacijsko. Zastopane so tako kvalitetno žgane sklede, izdelane v TS 2, 8 in 11, kot tudi grobo izdelane, porozne sklede (TS 9, 10).

*Okras:* Večina skled tega tipa je ornamentiranih. Pri varianti 2a prevladuje valovnica, ki je v večini primerov dokaj natančno izdelana. Lahko je enojna (*t.* 77: 1–2, 6–7, 9, 12; 78: 3; 79: 2, 6), dvojna (*t.* 77: 4) ali večlinijska (*t.* 78: 7, 9). Lahko je kombinirana z metličanjem (*t.* 77: 4; 78: 9), žlebljenjem (*t.* 77: 1–2, 9; 105: 1) ali žigosanjem (*t.* 78: 5). Pri varianti 2b se pojavljata metličenje (*t.* 78: 15; 79: 1, 3–4) in valovnica, ki je v nekaterih primerih izvedena manj natančno (*t.* 78: 3–4; 79: 6).

*Lega:* Sklede variante 2a se začnejo pojavljati že v plasteh prve poznoantične faze, prevladujejo pa v drugi. Maloštevilni kosi v zgodnjersrednjeveških plasteh pomenijo verjetno residualne kose. Varianta 2b se je bila najdena samo v plasteh druge poznoantične faze.

*Analogije:* Sklede tega tipa so zelo pogoste na Invillinu, kjer ustrezajo tipu Ia (Bierbrauer 1987, *t.* 86: 10, 13; 99: 17–20; 100: 9, 14; 104: 10; 105: 9, 14; 112: 6; 113: 14; 114: 10; 115: 8; 130: 12–13). Najdene so bile tudi na Castelraimundu (Covizzi 1995, *t.* 14: C 1689), v Vidulisu in Coseanu (Rupel 1988, št. 26, 73–76, 79–80, 93, 113, 116), Kopru (Cunja 1996, *t.* 37: 393), Predloki (Boltin-Tome 1993, *t.* 2: 1–2), na Križni gori (Ciglencečki 2000, *sl.* 108: 7), Ajdni (Meterc 1981, *t.* 1: 2–3), Gradcu pri Prapretnem (Ciglencečki 1981, *t.* 2: 9–10; 3: 18), Zbelovski gori (Ciglencečki 2000, *sl.* 91: 17), Brinjevi gori (Ciglencečki 2000, *sl.* 94: 12), Tinju (Ciglencečki 2000, *t.* 27: 12–13; 28: 1–2), Šenturški gori (Rodriguez 1997, *t.* 6: 53, 55), v Teurniji (Rodriguez 1990, *t.* 4: 1) in na Kappeli (Felgenhauer-Schmiedt 1993, *t.* 11: 9, 11; 13: 6–9; 17: 4, 7; 28: 10). Na Sv. Hemi mu ustrezata tipa 5.1 in 5.2 (Ladstätter 2000, 146, *t.* 2: 4–5).

*Datacija:* Pojav skled 2a na Tonovcovem gradu lahko na podlagi njihove lege postavimo že v drugo polovico 4. in začetek 5. st. skupaj z varianto 2b pa prevladujejo v 6. st. Podobna datacija je postavljena na Sv. Hemi, kjer so sklede z ravno odrezanim ustjem ravno tako značilne za 6. st. (Ladstätter 2000, 146).

### Tip 3 (*t.* 79: 9–16; 80; 81)

*Oblika:* V tip 3 sodijo na Tonovcovem gradu zelo pogoste sklede s polkrožno oblikovanim ostenjem in

*Decoration:* Most bowls belonging to this type were decorated. In type 2a the wavy line was the most common form of decoration, and in most cases it was made with relative precision. The wavy line could be single (*Pls.* 77: 1-2, 6-7, 9, 12; 78: 3; 79: 2, 6), double (*Pl.* 77: 4) or multiple (*Pl.* 78: 7, 9). It could be combined with brush strokes (*Pls.* 77: 4; 78: 9), grooves (*Pls.* 77: 1-2, 9; 105: 1) or impressions (*Pl.* 78: 5). In variant 2b brush strokes (*Pls.* 78: 15; 79: 1, 3-4) appeared alongside the wavy line, which was in some cases produced with less precision (*Pls.* 78: 3-4; 79: 6).

*Position:* Bowls type 2a started appearing already in the Late Antiquity 1 layers, however most were found in Late Antiquity 2 layers. The low numbers discovered in the Early Medieval layers most likely represent residual pieces. Variant 2b was discovered only in Late Antiquity 2 layers.

*Analogies:* Bowls type 2 are very common on Invillino, where they correspond to type Ia (Bierbrauer 1987, *Pls.* 86: 10, 13; 99: 17-20; 100: 9, 14; 104: 10; 105: 9, 14; 112: 6; 113: 14; 114: 10; 115: 8; 130: 12, 13). They were found also on Castelraimondo (Covizzi 1995, *Pl.* 14: C 1689), in Vidulis and Coseano (Rupel 1988, Nos. 26, 73-76, 79-80, 93, 113, 116), Koper (Cunja 1996, *Pl.* 37: 393), Predloka (Boltin-Tome 1993, *Pl.* 2: 1-2), on Križna gora (Ciglencečki 2000, *Fig.* 108: 7), Ajdna (Meterc 1981, *Pl.* 1: 2-3), Gradec near Prapretno (Ciglencečki 1981, *Pls.* 2: 9-10; 3: 18), Zbelovska gora (Ciglencečki 2000, *Fig.* 91: 17), Brinjeva gora (Ciglencečki 2000, *Fig.* 94: 12), Tinje (Ciglencečki 2000, *Pls.* 27: 12-13; 28: 1-2), Ulrichsberg (Rodriguez 1997, *Pl.* 6: 53, 55), in Teurnia (Rodriguez 1990, *Pl.* 4: 1) and Kappele (Felgenhauer-Schmiedt 1993, *Pls.* 11: 9, 11; 13: 6-9; 17: 4, 7; 28: 10). On Hemmaberg they correspond to types 5.1 and 5.2 (Ladstätter 2000, 146, *Pl.* 2: 4-5).

*Date:* Taking their position into account we can place the appearance of type 2a bowls at Tonovcov grad already into the second half of the 4<sup>th</sup> century and beginning of the 5<sup>th</sup> century. Together with type 2b they were dominant in the 6<sup>th</sup> century. A similar date was ascertained for Hemmaberg, where bowls with a rim cut off in a straight line were also characteristic of the 6<sup>th</sup> century (Ladstätter 2000, 146).

### Type 3 (*Pls.* 79: 9-16; 80; 81)

*Form:* At Tonovcov grad bowls with a semi-circular wall and a thickened rim edge belong into type 3 (*Pls.* 79: 9-16; 80; 81).<sup>41</sup> According to the basic wall forms type 3 is closely linked to type 2, it differs only in the shape of

<sup>41</sup> The bowls are reminiscent of some African Red Slip Ware forms, e.g. Hayes 99, dated into the end of the 5<sup>th</sup> and 6<sup>th</sup> century (Hayes 1972, 152-153; Bonifay 2004, 181, *Fig.* 96). The treated coarse ware bowls were commonly found already in Late Antiquity 1 layers, thus it can be assumed that this was not the influence of African Red Slip Ware on the local production.

TIP / TYPE 1

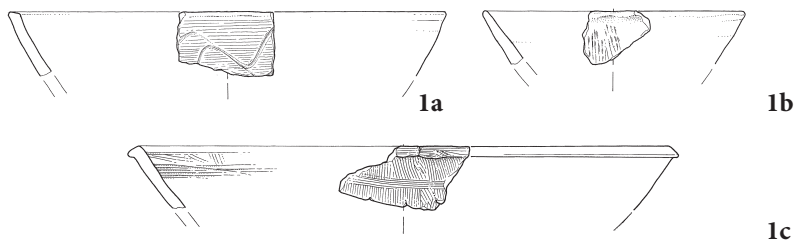

TIP / TYPE 2

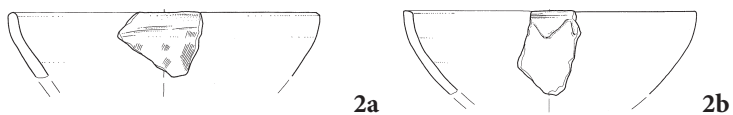

TIP / TYPE 3

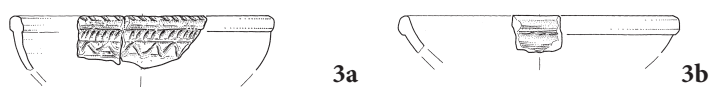

TIP / TYPE 4



TIP / TYPE 5

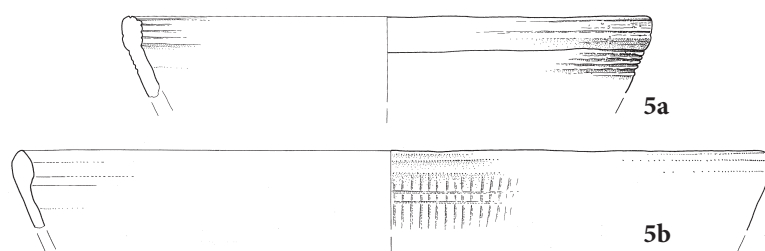

TIP / TYPE 6



TIP / TYPE 7

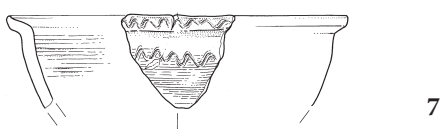

TIP / TYPE 8

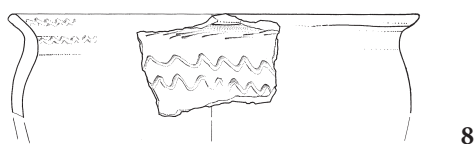

TIP / TYPE 9

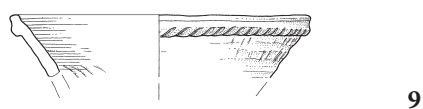

TIP / TYPE 10



Tab. 4.1: Tipi skled s Tonovcovega gradu. M. = 1:4.

Tab. 4.1: Bowl types from Tonovcov grad. Scale = 1:4.

odebeljenim robom ustja (t. 79: 9–16; 80; 81).<sup>41</sup> Po osnovni obliki ostenja so skledje tipa 3 ozko povezane s tipom 2, razlikujejo se le po obliki roba ustja. Uvrstitev v samostojni tip in ne v varianto tipa 2 se nam je zdela upravičena zaradi njihove številčnosti, saj predstavljajo skledje tipa 3 drugo največjo skupino na Tonovcovem gradu (sl. 4.12).

Glede na obliko roba ustja se oblikujeta dve varianti:

3a: Ustje je odebeljeno ali nekoliko izvlečeno samo na zunanji strani (t. 79: 9–16; 80: 1–3). Pri tej varianti prevladuje bolj stožčasta oblika ostenja.

3b: Ustje je odebeljeno na zunanji in notranji strani (t. 80: 4–16; 81: 1–14; 102: 4; 103: 3). V nekaterih primerih je lahko na zgornjem notranjem robu tudi odrezano oziroma usločeno (t. 80: 2,7,15; 81: 1,8–11).<sup>42</sup> Večinoma gre za bolj pokončno oblikovane skledje.

*Velikost:* Večina skled je majhnih do srednje velikih (premer ustja med 10 in 20 cm) in dokaj tankih sten. Dve veliki skledi premera 27 in 30 cm (t. 81: 9–10) se po bolj ostri oblikovanosti ustja že približujeta tipu 5a.

*Izdelava:* Prevladujejo dokaj kvalitetno (tako oksidacijsko kot redukcijsko) žgane skledje v tehnoloških skupinah 2, 6 in 8, dokaj pogosto pa so izdelane tudi v tehnološki skupini 14, ki je nekontrolirano žgana, z dodatkom velikih kalcitnih vključkov.

*Okras:* Večina posod tega tipa je okrašenih, neokrašene so le redke izjeme. Med neokrašenimi prevladujejo skledje variante 3a, medtem ko so skledje variante 3b okrašene vse razen treh (t. 81: 4–6). Prevladuje okras valovnice, ki je lahko enojna ali večlinijska. Večinoma je izvedena kvalitetno, z veliko amplitudo, čeprav se pojavljajo tudi bolj nepravilno izvedene (predvsem enojne) valovnice (t. 80: 16; 81: 13). Valovnica na skledah tipa 3 nikoli ne nastopa samostojno, vedno je v povezavi z drugimi vrstami okrasa. To je lahko metličenje, pa tudi različni vbodi in vrezi na ustju in ostenju. Pogosta je večlinijska valovnica, kombinirana z metličanjem (t. 80: 1,9–10; 81: 1). Enojna valovnica se lahko povezuje z žlebljenjem (t. 79: 15–16; 80: 14), vbodi in vrezi (t. 79: 16; 80: 3,6,12–13; 81: 1,12–14). Lahko je kombiniranih tudi več tehnik (valovnica, žlebljenje, vbodi, vrezi: t. 80: 1,6,10,12–13; 81: 1). Zelo priljubljeno je krašenje roba ustja z žigi ali vrezi, ki se vedno povezujejo tudi z okrasom na ostenju.

*Lega:* Skledje tipa 3 se že pojavljajo v plasteh prve poznoantične faze (varianta 3b), obe varianti sta pogo-

<sup>41</sup> Skledje spominjajo na nekatere oblike afriške sigilate, npr. Hayes 99, datirane v konec 5. in 6. st. (Hayes 1972, 152–153; Bonifay 2004, 181, sl. 96) Obravnavane skledje iz grobe keramike pa so pogoste že v plasteh prve poznoantične faze, tako da v tem primeru verjetno ne gre za vpliv afriške sigilate na lokalno produkcijo.

<sup>42</sup> V tem primeru ustreza tipu 5, var. 4 po Ladstätter (2000, 146).

the rim edge. The classification into an independent type and not into a subtype of type 2 seemed to be justified due to their frequency, for type 3 bowls represent the second most numerous group at Tonovcov grad (Fig. 4.12).

Two variants were formed according to the shape of the rim edge:

3a: The rim is thickened or somewhat pulled out on the outer side (Pls. 79: 9-16; 80: 1-3). In this type the body tends to be more conical in shape.

3b: The rim is thickened on the outer and inner side (Pls. 80: 4-16; 81: 1-14; 102: 4; 103: 3). In some cases it can also be cut off or concave on the upper inner edge (Pls. 80: 2,7,15; 81: 1,8-11).<sup>42</sup> Most of the bowls had a slightly more vertically shaped body.

*Size:* Most bowls are small or medium sized (rim diameter measuring between 10 and 20 cm) and have relatively thin walls. Two large bowls with a diameter measuring 27 and 30 cm (Pl. 81: 9-10) are closer to type 5a due to their sharp rim.

*Manufacture:* Most of them are relatively high quality (oxidised and reduced) fired bowls that belong to technological groups 2, 6 and 8. Also common were bowls manufactured in technological group 14, which was fired in uncontrolled conditions, with coarse calcite inclusions.

*Decoration:* Most of these vessels were decorated, only rarely were they undecorated. Most of the undecorated bowls belong to type 3a, while bowls type 3b were all decorated – with the exception of three examples (Pl. 81: 4-6). The wavy line was the most dominant type of decoration, whether single or multiple. In most cases the wavy line was of high quality, with a large amplitude, even though irregularly shaped ones (predominantly single wave) also appeared (Pls. 80: 16; 81: 13). The wavy line on type 3 bowls never appeared on its own, for it was always found in connection with other decorations. These decorations included brush strokes, as well as various punctures and cuts found on the rim and the body. Multiple wavy lines combined with brush strokes were common (Pls. 80: 1,9-10; 81: 1). A single wavy line could be combined with grooves (Pls. 79: 15-16; 80: 14), impressions or incisions (Pls. 79: 16; 80: 3,6,12-13; 81: 1,12-14). Numerous techniques (wavy lines, grooves, impressions, incisions: Pls. 80: 1,6,10,12-13; 81: 1) could also be combined. Decorating the rim edge with impressions or incisions was also popular, and this was always combined with decorated walls.

*Position:* Type 3b bowls appeared already in Late Antiquity 1 layers, while both subtypes were common in Late Antiquity 2 layers. They were rare in Early Medieval layers.

*Analogies:* These bowls were exceptionally popular at Tonovcov grad. They were also discovered in other sites in Friuli and western Slovenia, but nowhere in such high numbers and with such diverse decoration. At Invillino these bowls belong to types Ie and Ih (Bierbrauer 1987,

<sup>42</sup> In this case it corresponds to type 5, subtype 4 according to Ladstätter (2000, 146).



sti v drugi poznoantični fazi. V zgodnjerednjevskih plasteh so redke.

*Analogije:* Gre za skledе, ki so bile na Tonovcovem gradu zelo priljubljene. Na drugih najdiščih Furlanije in zahodne Slovenije so sicer poznane, vendar nikjer niso zastopane v tako velikem številu in s tako raznolikim okrasom. Skledе tega tipa na Invillinu ustrezajo tipoma Ie in Ih (Bierbrauer 1987, t. 71: 6–8; 72: 6), so pa dokaj redke. Večinoma so okrašene z metličanjem, valovnica se ne pojavlja. Nekoliko bolj pogoste so na Castelraimond, vendar pa tudi tu med objavljenim gradivom ni okrasa valovnice, zastopana pa sta metličanje in vbodi (Covizzi 1995, t. 9: C 1993, C 2380; 10: C 2468, C 1213, C 2326; 12: C 1858, C 1930, C 2072; 13: C 2122; 14: C 6171, C 6172; 15: C 6092). Pogoste so tudi v Vidulisu (Rupel 1988, št. 21–24) in Coseanu (Rupel 1988, št. 77–78,81–83,90–91). Tu se pojavljata tako manjša kot velika varianta, med okrasom prevladuje metličanje, ni pa valovnice. Posamezni primeri takih skled so poznani še s Križne gore (Ciglencečki 2000, sl. 108: 5,7) in Ajdne (Ciglencečki 2000, sl. 124: 2, okrašena z valovnico). Na zahodnem cerkvenem kompleksu Sv. Heme so skledе tipa 3 redke (ustrezajo varianti 3 in 4 tipa 5: Ladstätter 2000, 146, t. 17: 3).

*Datacija:* Vsekakor so bile na Tonovcovem gradu v uporabi že v drugi polovici 4. in začetku 5. st, vrhunec njihove priljubljenosti pa je 6. st. V 4. st. so datirane na Sv. Hemi (Ladstätter 2000, 146). Na Castelraimond sodijo v fazo 4a (270–430 – okrašene z metličanjem) in 5a (430–550 – okrašene z rebri), na Invillinu pa so značilne za fazo II (Bierbrauer 1987, 209).

#### Tip 4 (t. 82: 1–4; 105: 3–4)

*Oblika:* V tip 4 sodijo skledе, katerih ostenje poteka v spodnjem delu stožčasto, v zgornjem delu pa se zalomi in je postavljeno pokončno ali nagnjeno navznoter (t. 82: 1–4; 105: 3–4). Rob ustja je ravno odrezan ali zaobljen, lahko na notranji strani rahlo odebeljen.

*Velikost:* Skledе so v glavnem srednje velike, s premerom ustja med 15 in 18 cm.

*Izdelava:* Najdene so bile tako kvalitetno izdelane skledе (TS 2, 7), kot tudi skledе mehke, porozne fature (TS 9).

*Okras:* Večina je okrašenih, izjema je samo skleda z območja cerkvenega sklopa (t. 105: 4). Pojavljajo se enojna valovnica, metličanje in vrezji.

*Lega:* Skledе izvirajo plasti iz druge poznoantične faze in iz premešanih plasti.

*Analogije:* Na Tonovcovem gradu so redke, čeprav je to tip, ki je dokaj priljubljen na jugovzhodnoalpskem prostoru. Na Invillinu jim ustrezajo nekateri primeri tipov Ia in Ib (Bierbrauer 1987, t. 70: 2,4,6,8–12; 79: 22–23; 96: 7; 115: 10; 117: 3,12; 131: 3–5). Na kraških najdiščih so bile podobne skledе najdene na Rodiku (Ciglencečki 2000, sl. 116: 2–3) in Križni gori (Ciglencečki 2000, sl. 108: 6),

Pls. 71: 6–8; 72: 6), and are relatively rare. Most of them were decorated with brush strokes, while wavy lines were non-existent. They were somewhat more common on Castelraimondo; however, the published material from this site also fails to reveal the wavy line decoration, even though the brush stroke and impressions were present (Covizzi 1995, Pls. 9: C 1993, C 2380; 10: C 2468, C 1213, C 2326; 12: C 1858, C 1930, C 2072; 13: C 2122; 14: C 6171, C 6172; 15: C 6092). Such bowls were also common in Vidulis (Rupel 1988, Nos. 21–24) and Coseano (Rupel 1988, Nos. 77–78,81–83,90–91), where they appeared in small and large versions, most commonly decorated by brush strokes, while wavy lines were unknown. Individual examples of such bowls were also found at Križna gora (Ciglencečki 2000, Fig. 108: 5,7) and Ajdna (Ciglencečki 2000, Fig. 124: 2, decorated with wavy line). Type 3 bowls were rare in the western ecclesiastical complex at Hemmaberg (they correspond to variants 3 and 4 of type 5: Ladstätter 2000, 146, Pl. 17: 3).

*Date:* At Tonovcov grad they were certainly in use already in the second half of the 4<sup>th</sup> and beginning of the 5<sup>th</sup> century, however the 6<sup>th</sup> century saw them reach the peak of their popularity. The examples found at Hemmaberg were dated into the 4<sup>th</sup> century (Ladstätter 2000, 146). On Castelraimondo they could be placed into phase 4a (270–430 – brush stroke decoration) and 5a (430–550 – rib decoration), while on Invillino they were characteristic for phase II (Bierbrauer 1987, 209).

#### Type 4 (Pls. 82: 1–4; 105: 3–4)

*Form:* In this type the walls were conical in the lower part, and continued vertically or were tilted towards the inside in the upper part (Pls. 82: 1–4; 105: 3–4). The rim edge was cut off in a straight line or rounded, and could be slightly thickened on the inner side.

*Size:* Most of the bowls were medium sized, with the rim diameter measuring between 15 and 18 cm.

*Manufacture:* This type included high quality bowls (TG 2, 7), as well as bowls made from soft, porous fabric (TG 9).

*Decoration:* Most of them were decorated, with the sole exception of the bowl found within the ecclesiastical complex (Pl. 105: 4). They could be decorated by a single wavy line, brush strokes or incisions.

*Position:* Bowls were found in Late Antiquity 2 layers and in mixed layers.

*Analogies:* Even though this type was relatively popular in the Southeastern Alps, they were rare at Tonovcov grad. At Invillino similarity can be found in some type Ia and Ib examples (Bierbrauer 1987, Pls. 70: 2,4,6,8–12; 79: 22–23; 96: 7; 115: 10; 117: 3,12; 131: 3–5). In Karst sites similar bowls were found at Rodik (Ciglencečki 2000, Fig. 116: 2–3) and Križna gora (Ciglencečki 2000, Fig. 108: 6), various versions of this type (ones with a thickened rim

različne variante tega tipa (prevladujejo takšne z odebeljenim ustjem) se pojavljajo tudi na Hrušici (Giesler 1981, t. 39: 14–16, 18–26; 45: 21–26), zelo pogoste so v Akvileji (Rupel 1994, t. 32: CCg 65–67; 33: 69–77; 34: 78–81). V osrednji Sloveniji so bile najdene na Ajdnu (Meterc 1981, t. 1: 2; 2: 7; Ciglenečki 2000, sl. 124: 3–4), Brinjevi gori (Ciglenečki 2000, sl. 95: 4–6; 96: 1–5), Rifniku (Bolta 1981, t. 24: 68–69, 71–72), Vranju (Knific 1979, št. 133; Mirnik-Prezelj 1984, t. 23: 221–225), Zbelovski gori (Ciglenečki 2000, sl. 91: 20), Tinju (Ciglenečki 2000, t. 28: 6–8; 29: 1) ter na hrvaškem Kuzelinu (Sokol 1994, t. 4: 9, 11). Poznane so tudi z avstrijske Koroške. Na Sv. Hemi so uvrščene v tip 4 (Ladstätter 2000, 145, t. 16: 1–3), najdene so bile tudi na Šenturški gori (Rodriguez 1997, t. 6: 52, 54), Teurniji (Rodriguez 1997, t. 1: 8), Duelu (Steinklauber 1990, 27–30) in Kappeli (Felgenhauer-Schmiedt 1993, t. 22: 20, 22; 23: 27, 29).

*Datacija:* Sklede tega tipa se pojavljajo v pozno-rimskih in poznoantičnih kontekstih na širokem območju od podonavskega prostora do jugovzhodnih Alp (Ladstätter 2000, 145, op. 896 in 897). V času 4. st. prevladuje oblika z odebeljenim ustjem (npr. Hrušica, Akvileja). Sklede s stanjšanim ustjem naj bi bile značilne za drugo polovico 6. st. (Ladstätter 2000, 145). Sklede tipa 4 so bile očitno bolj priljubljene na vzhodnem delu jugovzhodnoalpskega prostora. Vsekakor pa gre za zelo dolgotrajno obliko, saj so bile podobne sklede najdene tudi v zgodnjesevnoantičnih kontekstih v severni Italiji (Lusuardi Siena, Negri, Villa 2004, t. 6: 9). Na Tonovcovem gradu v nobeni fazi niso bile posebno priljubljene, še največ jih izvira iz plasti 6. st. (sl. 4.12).

**Tip 5** (t. 82: 5–9; 83; 84: 1–5; 103: 7; 105: 5)

*Oblika:* To so velike sklede s stožčastim ali rahlo kroglastim ostenjem in odebeljenim, pokončno postavljenim ustjem. Po obliki so sicer zelo podobne skledam tipa 3 (predvsem varianta 5a), vendar se od njih razlikujejo po velikosti ter izvedbi ustja. Glede na oblikovanost ustja ločimo dve varianti:

5a: Ustje je ostro odebeljeno na zunanji in notranji strani, tako, da v profilu tvori štirikotnik (t. 82: 5–9; 83: 1–8; 103: 7; 105: 5).

5b: Ustje je zaobljeno odebeljeno na zunanji in notranji, lahko tudi samo na notranji strani (t. 83: 9–11; 84: 1–5).

*Velikost:* Pri vseh skledah, kjer je možna rekonstrukcija premera, gre za velike posode s premerom nad 27 cm, prevladujejo pa nad 30 cm široke sklede. Vse sklede tega tipa so tudi dokaj globoke.

*Izdelava:* Pri obeh variantah izrazito prevladujejo oksidacijsko žgane sklede, izdelane v tehnoloških skupinah 2 in 6. Izstopata pa obe skledi, okrašeni z večlinijsko valovnico (t. 83: 1; 105: 5), ki sta bili redukcijsko žgani (TS 4).

prevail) were found at Hrušica (Giesler 1981, Pls. 39: 14-16, 18-26; 45: 21-26), and they were very common in Aquileia (Rupel 1994, Pls. 32: CCg 65-67; 33: 69-77; 34: 78-81). In central Slovenia they were discovered at Ajdna (Meterc 1981, Pls. 1: 2; 2: 7; Ciglenečki 2000, Fig. 124: 3-4), Brinjeva gora (Ciglenečki 2000, Figs. 95: 4-6; 96: 1-5), Rifnik (Bolta 1981, Pls. 24: 68-69, 71-72), Vranje (Knific 1979, No. 133; Mirnik-Prezelj 1984, Pl. 23: 221-225), Zbelovska gora (Ciglenečki 2000, Fig. 91: 20), Tinje (Ciglenečki 2000, Pls. 28: 6-8; 29: 1) and in Croatia on Kuzelin (Sokol 1994, Pl. 4: 9, 11). They were also found in Austrian Carinthia. At Hemmaberg they were classified into type 4 (Ladstätter 2000, 145, Pl. 16: 1-3), and they were also found on Ulrichsberg (Rodriguez 1997, Pl. 6: 52, 54), in Teurnia (Rodriguez 1997, Pl. 1: 8), Duel (Steinklauber 1990, 27-30) and Kappel (Felgenhauer-Schmiedt 1993, Pls. 22: 20, 22; 23: 27, 29).

*Date:* This type was discovered in Late Roman and Late Antique contexts in a broad area reaching from the Danube river to the Southeastern Alps (Ladstätter 2000, 145, notes 896 and 897). In the 4<sup>th</sup> century the shape with the thickened rim was the most common (Hrušica, Aquileia). Bowls with a thinned rim were more common in the second half of the 6<sup>th</sup> century (Ladstätter 2000, 145). Bowls type 4 were obviously more popular in the eastern part of the Southeastern Alps. This was a long-lasting shape, for similar bowls were found in Early Medieval contexts in northern Italy (Lusuardi Siena, Negri, Villa 2004, Pl. 6: 9). They were not especially popular at Tonovcov grad in any of its phases, however most of the ones that were discovered were located in the 6<sup>th</sup> century layer (Fig. 4.12).

**Type 5** (Pls. 82: 5-9; 83; 84: 1-5; 103: 7; 105: 5)

*Form:* These are large bowls with conical or slightly rounded wall and a thickened, upright rim. In their shape they are very similar to type 3 (especially type 5a), however they differ in their size and in the treatment of the rim. Taking into account the rim shape this type can be divided into two variants:

5a: The rim was sharply thickened on the outer and inner side so that it formed a rectangular profile (Pls. 82: 5-9; 83: 1-8; 103: 7; 105: 5).

5b: The rim was rounded on the outer and inner side, sometimes only on the inner side (Pls. 83: 9-11; 84: 1-5).

*Size:* All bowls for which the diameter could be reconstructed have shown that they were large bowls with a diameter exceeding 27 cm, and most of them even exceeded 30 cm in diameter. All bowls belonging to this type were also relatively deep.

*Manufacture:* Oxidised fired bowls prevailed within both variants and most of them were manufactured in technological groups 2 and 6. The two bowls decorated with the multiple wavy lines step out (Pls. 83: 1; 105: 5), for they were both reduction fired (TG 4).

**Okras:** Pri skledah obeh variant prevladuje dokaj grobo metličenje, ki v večini primerov poteka v več smereh, tako da tvori značilen "mrežast" vzorec (t. 82: 8-9; 83: 2,10-11; 84: 1-5). Dokaj pogosto je tudi žlebljenje, ki se navadno pojavlja na ustju, lahko pa tudi na ostenju variante 5a (t. 82: 6-7; 83: 1,4-5,8), medtem ko se pri varianti 5b ne pojavlja. Pri varianti 5a je lahko z žigi oziroma vbodi razčlenjen vrhni rob ustja (t. 83: 7-8). V dveh primerih (t. 83: 1; 105: 5) sta skledi variante 5a okrašeni z večlinijsko, kvalitetno izvedeno valovnico. Sklede tipa 5b so okrašene skoraj izključno z metličanjem, le v enem primeru se pojavlja žlebljen zunanji rob ustja (t. 83: 11).

**Lega:** Obe varianti se začeta pojavljati že v plasteh prve poznoantične faze. Varianta 5a v njih prevladuje, medtem ko je varianta 5b pogostejša v plasteh druge poznoantične faze. Redke primere iz zgodnjerednjeveških plasti lahko opredelimo kot residualne kose.

**Analogije:** Tipu 5a analogij na bližnjih najdiščih ni bilo mogoče najti. Skledam tipa 5b lahko tako za obliko kot za ornament najdemo primerjave na Castelraimondo (Covizzi 1995, sl. 31: C 1993; t. 12: C 2072; Martelli 1995, C 1130). Na Invillinu ustrezajo nekaterim (velikim) skledam, ki so dovršene v tip I e (Bierbrauer 1987, t. 71: 7-8; 87: 16; 111: 6) oziroma I d (Bierbrauer 1987, t. 71: 1).

**Datacija:** Glede na stratigrafsko lego lahko začetek tega tipa postavimo v drugo polovico 4. st., njegovo največjo priljubljenost pa v 6. st.

**Tip 6** (t. 84: 6-13; 102: 5; 105: 6-7; 106: 9).

**Oblika:** To so sklede s kroglastim, navznoter nagnjenim ostenjem (t. 84: 6-13; 102: 5; 105: 6-7; 106: 9). Rob ustja je lahko neodebeljen ali rahlo odebeljen. Zaradi majhnega števila skled tega tipa variant ustja nismo ločevali.

**Velikost:** Prevladujejo majhne in srednje velike sklede, izjema je skleda t. 84: 13 s 36 cm premera.

**Izdelava:** Sklede tipa 6 kažejo dokaj enotno izdelavo. Prevladujejo kvalitetne, redukcijsko žgane sklede, izdelane v tehnoloških skupinah 8 in 14. Izjema je samo skleda, najdena v cisterni (t. 106: 9), ki je bila izdelana prostoročno, iz dokaj mehko žgane, porozne gline (TS 13).

**Okras:** Veliko skled je okrašenih, prevladuje valovnica, ki je lahko enolinijska (t. 84: 9,11) ali večlinijska (t. 84: 7,10,12), lahko tudi v kombinaciji z metličanjem (t. 84: 7) ali žlebljenjem (t. 84: 12). Nekaj skled je tudi neokrašenih.

**Lega:** Sklede tega tipa se pojavljajo že v plasteh prve poznoantične faze, zastopane pa so tudi še v plasteh druge poznoantične faze in v zgodnjerednjeveški plasti (skleda t. 106: 9).

**Analogije:** Na Invillinu so take sklede redke (Bierbrauer 1987, t. 79: 23; 80: 2,4). Poznane so iz Akvileje (Rupel 1994, t. 34: CCg 87), na Hrušici je taka oblika

**Decoration:** Relatively coarse brush strokes prevailed within both types, and in most cases this was applied in various directions, so that they formed a characteristic 'net' pattern (Pls. 82: 8-9; 83: 2,10-11; 84: 1-5). Grooves were also a relatively common decoration feature; most commonly they appeared on the rim, or on the walls of type 5a (Pls. 82: 6-7; 83: 1,4-5,8), however none could be found on type 5b. The upper edge of the type 5a rim could be divided by stamps or impressions (Pl. 83: 7-8). Two examples (Pls. 83: 1; 105: 5) of a type 5a bowl were decorated with high quality multiple wavy lines. Type 5b bowls were decorated merely with brush strokes; a single case was found with a grooved outer rim edge (Pl. 83: 11).

**Position:** Both subtypes were found already in Late Antiquity 1 layers. Type 5a was more common in LA 1 layers, while type 5b was more common in Late Antiquity 2 layers. The few examples from the Early Medieval layers can be defined as residual fragments.

**Analogies:** There are no analogies for type 5a in the nearby sites. Bowls type 5b have analogies in their forms as well as ornaments at Castelraimondo (Covizzi 1995, Fig. 31: C 1993; Pl. 12: C 2072; Martelli 1995, C 1130). At Invillino they correspond to some (large) bowls that were categorised as type I e (Bierbrauer 1987, Pls. 71: 7-8; 87: 16; 111: 6) or I d (Bierbrauer 1987, Pl. 71: 1).

**Date:** Taking into account the stratigraphic position we can place the beginning of this type into the second half of the 4<sup>th</sup> century and determine that reached the peak of its popularity in the 6<sup>th</sup> century.

**Type 6** (Pls. 84: 6-13; 102: 5; 105: 6-7; 106: 9)

**Form:** These bowls had rounded, inward leaning walls (Pls. 84: 6-13; 102: 5; 105: 6-7; 106: 9). The rim edge could be non-thickened or slightly thickened. Due to the low number of discovered bowls belonging to this type we did not subdivide them according to their rim types.

**Size:** Small and medium sized bowls were the most common, with the sole exception being the bowl Pl. 84: 13 which measured 36 cm in diameter.

**Manufacture:** Type 6 bowls showed a relatively unified production. High quality, reduced fired bowls manufactured in technological groups 8 and 14 were the most common. The only exception was represented by the hand made bowl made from relatively soft fired, porous clay (TG 13), which was found in the water cistern (Pl. 106: 9).

**Decoration:** Many bowls were decorated, most commonly by a single (Pl. 84: 9,11) or multiple (Pl. 84: 7,10,12) wavy line. In certain cases the wavy line could be found in combination with brush strokes (Pl. 84: 7) or grooves (Pl. 84: 12). Some of the bowls had no decoration.

**Position:** These bowl types appear already in Late Antiquity 1 layers, but can also be found in Late Antiquity 2 and Early Medieval layers (bowl Pl. 106: 9).

izvedena kot trinožnik (Vidrih Perko 1992b, t. 3: 9). Bolj pogoste so na vzhodu. Tako so znane z Gradca pri Prapretnem (Ciglenečki 1981, t. 6: 69), Brinjeve gore (Ciglenečki 2000, sl. 95: 1-2,5-6), Korinjskega hriba (Ciglenečki 2000, sl. 103: 15), Rifnika (Bolta 1981, t. 22: 58; 26: 83-84,86,88). Ustrezajo tipu 7 na Sv. Hemi (Ladstätter 2000, 146-147, t. 17: 5-6), vendar se tam ne pojavlja varianta z odebeljenim ustjem.

*Datacija:* Sklede imajo izvor v rimskodobnih oblikah (Ladstätter 2000, 146-147, op. 906). Njihovo priljubljenost v poznorimskem obdobju kažejo sklede iz Akvileje in s Hrušice. Na Tonovcovem gradu se pojavljajo tudi še v plasteh druge poznoantične faze in v zgodnjerednjeveških plasteh (sl. 4.12). Med skledami prve in druge poznoantične faze je opazna razlika v izdelavi. Sklede iz faze PA 1 so bolje izdelane in večinoma okrašene, medtem ko se v plasteh PA 2 in v ruševinskih plasteh pojavljajo bolj grobo izdelane, neokrašene sklede.

#### Tip 7 (t. 85: 1-3)

*Oblika:* V tip 7 so uvrščene sklede s polkrožnim ali klekastim ostenjem in poševno navzven izvihanim ustjem, ki je na notranjem robu lahko rahlo usločeno (t. 85: 1-3). Sklede tega tipa na Tonovcovem gradu niso pogoste, najdeni so bili samo trije primeri.

*Velikost:* Sodijo v skupino srednje velikih skled (premer med 18 in 21 cm).

*Izdelava:* Skleda t. 85: 3 sodi v TS 1, skledi t. 85: 1-2 pa kljub veliki oblikovni podobnosti v zelo različni tehnološki skupini. Skleda t. 85: 1 je trda, redukcijsko žgana, izdelana v tehnološki skupini 8, medtem ko ima skleda t. 85: 2 mehko površino, je neenakomerno žgana in sodi v tehnološko skupino 15.

*Okraša:* Ena skleda (t. 85: 3) je okrašena z valovnico na ustju in ostenju, dve pa nista okrašeni.

*Lega:* Skleda t. 85: 3 je bila najdena v plasti, ki pripada prvi poznoantični fazi, ostali dve pa sta iz plasti druge poznoantične faze.

*Analogije:* Podobna skleda je poznana s Castelraimonda (Covizzi 1995, sl. 6: C 1357), na Invillinu pa niso bile najdene. Sklede tega tipa so bile najdene tudi v Predloki (Boltin-Tome 1993, t. 3: 3), na Kučarju (J. Dular, Ciglenečki, A. Dular 1995, t. 2: 9), Korinjskem hribu (Ciglenečki 1985, t. 5: 64), Rifniku (Bolta 1981, t. 22: 56-57; 23: 35,38; 27: 72; Ciglenečki 2000, sl. 85: 1-3), Gradcu pri Prapretnem (Ciglenečki 1981, t. 4: 43; 7: 85), Tinju (Ciglenečki 2000, t. 30: 1-7), Vranju (Knific 1979, št. 177), Sv. Hemi (Ladstätter 2000, t. 17: 7; Rodriguez 1997, t. 8: 77), Šenturški gori (Rodriguez 1992, t. 3: 3; 1997, t. 6: 56,57), Teurniji (Rodriguez 1990, t. 4: 2-3; 1997, t. 1: 6-7), Kappelli (Felgenhauer-Schmiedt 1993, t. 22: 25) in na Duelu, kjer se kot lokalna oblika tega tipa pojavlja skleda s tremi nogami in odebeljenim ter spodrezanim zunanjim robom ustja (Steinklauber 1990, 118-119, sl.

*Analogies:* Such bowls were rare at Invillino (Bierbrauer 1987, Pls. 79: 23; 80: 2,4). They were found in Aquileia (Rupel 1994, Pl. 34: CCg 87), and at Hrušica this form was manufactured in a three-legged version (Vidrih Perko 1992b, Pl. 3: 9). They were more common in the east, were they were discovered in Gradec near Prapretno (Ciglenečki 1981, Pl. 6: 69), Brinjeva gora (Ciglenečki 2000, Fig. 95: 1-2,5-6), Korinjski hrib (Ciglenečki 2000, Fig. 103: 15), and Rifnik (Bolta 1981, Pls. 22: 58; 26: 83-84,86,88). They correspond to type 7 on Hemmaberg (Ladstätter 2000, 146-147, Pl. 17: 5-6), however not a single example of the version with the thickened rim was found there.

*Date:* The bowls originate from the Roman period forms (Ladstätter 2000, 146-147, note 906). Their popularity during the Late Roman period is indicated by the bowls from Aquileia and Hrušica. On Tonovcov grad they also appear in Late Antiquity 2 and Early Medieval layers (Fig. 4.12). A difference in manufacture can be noticed between Late Antiquity 1 and Late Antiquity 2 bowls. The production of bowls from LA 1 was of higher quality and in most cases these bowls were decorated, while the bowls found in LA 2 and in destruction layers were more likely to be of poorer quality and without decoration.

#### Type 7 (Pl. 85: 1-3)

*Form:* Type 7 consists of bowls with a semi-circular or carinated wall and an everted rim, which can be slightly concave on the inner edge (Pl. 85: 1-3). This type of bowl is not common at Tonovcov grad as only three examples were found.

*Size:* They belong into the group of medium sized bowls (diameter between 18 and 21 cm).

*Manufacture:* Bowl Pl. 85: 3 belongs into technological group 1, while bowls Pl. 85: 1-2 belong into different technological groups, even though they are similar in shape. Bowl Pl. 85: 1 is hard, reduced fired, made in technological group 8, while bowl Pl. 85: 2 has a soft surface, is unevenly fired and belongs into technological group 15.

*Decoration:* One bowl (Pl. 85: 3) was decorated with a wavy line on the rim and the walls, the other two were undecorated.

*Position:* Bowl Pl. 85: 3 was found in a Late Antiquity 1 layer, while the other two were discovered in a Late Antiquity 2 layer.

*Analogies:* Similar bowl was found on Castelraimondo (Covizzi 1995, Fig. 6: C 1357), however they were not found on Invillino. They were discovered also in Predloka (Boltin-Tome 1993, Pl. 3: 3), Kučar (J. Dular, Ciglenečki, A. Dular 1995, Pl. 2: 9), Korinjski hrib (Ciglenečki 1985, Pl. 5: 64), Rifnik (Bolta 1981, Pls. 22: 56-57; 23: 35,38; 27: 72; Ciglenečki 2000, Fig. 85: 1-3), Gradec near Prapretno (Ciglenečki 1981, Pls. 4: 43; 7: 85), Tinje (Ciglenečki 2000, Pl. 30: 1-7), Vranje (Knific

31–32). Na koroških najdiščih gre v večini primerov za zelo široke sklede premera okoli 30 cm (Ladstätter 2000, 147), medtem ko so tiste iz zahodnega dela Slovenije manjše.

Na zahodu je opazna prevlada skled z bolj zaokroženim ostenjem, ki so navadno tudi okrašene, na vzhodu pa prevladuje izrazito klekasta oblika, ki je navadno neokrašena ali okrašena le z žlebljenjem.

*Datacija:* Na Tonovcovem gradu lahko njihov začetek na podlagi sklede t. 85: 3 postavimo v drugo polovico 4. oziroma začetek 5. st. Datacija v 5. st. velja tudi za primer s Kučarja. Na Castelraimundu sodijo v fazo IVa (Covizzi 1995, 51), sklede podobne oblike, vendar večjega premera pa so na Sv. Hemi datirane v 6. st. (Ladstätter 2000, 147). Vsekakor gre za obliko, ki se pojavlja že v 5. st., očitno pa ostane v uporabi tudi še v 6. st.

#### Tip 8 (t. 85: 4)

*Oblika:* Samo z enim primerom je zastopana skleda z izvihanim ustjem, ki prehaja v kroglasto ostenje (t. 85: 4). Širina ustja je približno enaka širini največjega oboda. Skleda po obliki ustja spominja na lonce tipa 1, med sklede je uvrščena, ker je nižja in širša.

*Velikost:* Sodi v skupino srednje velikih skled (premer ustja 21 cm).

*Izdelava:* Je trda, redukcijsko žgana, izdelana v TS 7.

*Okras:* Okrašena je s po dvema enolinijskima valovnicama na notranji strani ustja in na ostenju.

*Leg:* Skleda izvira iz premešanih plasti.

*Analogije:* Gre za dokaj redko obliko. V zahodni Sloveniji so bile podobne sklede najdene v Piranu (Vidrih Perko 1994a, sl. 5: 1), Kopru (Cunja 1996, t. 33: 357) in v Kranju – lokacija Kieselstein (Sagadin 2008, t. 5: 6). Na vzhodu je podobna oblika poznana še z Ančnikovega gradišča (Strmčnik 1997, t. 4: 15).

*Datacija:* Datacija na podlagi lege na Tonovcovem gradu ni mogoča. Glede na analogije v Kopru in Piranu bi lahko sklepali, da se pojavljajo predvsem v 6. st. Morda bi jih lahko primerjali s podobno oblikovanimi skledami, ki pa imajo bolj izrazito klekasto ostenje (Ajdna: Meterc 1981, t. 1: 1; Rifnik: Bolta 1981, t. 26: 82; Sv. Hema: Ladstätter 2000, t. 18: 1–2) in naj bi spadale med langobardsko vplivane oblike iz časa konca 6. in začetka 7. st. (Ladstätter 2000, 148).

#### Tip 9 (t. 85: 5)

*Oblika:* Gre za globoko, v zgornjem delu konično skledo oziroma kozico z odebeljenim, na spodnjem robu ravno odrezanim ustjem. Dno je prstanasto (t. 85: 5). Tudi ta oblika je na Tonovcovem gradu zastopana le z enim primerom.

*Velikost:* Skleda ima premer 15 cm.

1979, No. 177), Hemmaberg (Ladstätter 2000, Pl. 17: 7; Rodriguez 1997, Pl. 8: 77), Ulrichsberg (Rodriguez 1992, Pl. 3: 3; 1997, Pl. 6: 56–57), Teurnia (Rodriguez 1990, Pl. 4: 2–3; 1997, Pl. 1: 6–7), Kappel (Felgenhauer-Schmiedt 1993, Pl. 22: 25) and Duell, where the local form of this type appears as a bowl with three legs and a thickened and undercut rim edge (Steinklauber 1990, 118–119, Figs. 31–32). In Carinthian sites most examples are represented by wide bowls with a diameter of approximately 30 cm, while those from western Slovenia are smaller.

In the west bowls with a more rounded wall and rich decoration prevailed, and in the east a predominantly carinated shape prevailed, most commonly not decorated or decorated solely with grooves.

*Date:* On the basis of bowl Pl. 85: 3 we can place the beginning of this type on Tonovcov grad into the second half of the 4<sup>th</sup> or beginning of the 5<sup>th</sup> century. The example from Kučar also belongs to the 5<sup>th</sup> century. On Castelraimondo the type belongs to phase IVa (Covizzi 1995, 51), and on Hemmaberg similar shape bowls but with a larger diameter were dated into the 6<sup>th</sup> century. It is obvious that this shape appeared in the 5<sup>th</sup> century and remained in use in the 6<sup>th</sup> century.

#### Type 8 (Pl. 85: 4)

*Form:* A single bowl with an everted rim that leads into a rounded wall was discovered (Pl. 85: 4). The width of the rim was approximately the same as the width of the largest circumference. According to the rim shape the bowl should be placed amongst pots type 1, however it is classified as a bowl because it is lower and wider.

*Size:* It is a medium sized bowl (rim diameter 21 cm).

*Manufacture:* Is hard, reduced fired, manufactured in TG 7.

*Decoration:* It is decorated with two individual wavy lines on the rim's inner side and on the walls.

*Position:* The bowl was found in mixed layers.

*Analogies:* This is a relatively rare shape. In western Slovenia similar bowls were found in Piran (Vidrih Perko 1994a, Fig. 5: 1), Koper (Cunja 1996, Pl. 33: 357) and Kranj – location Kieselstein (Sagadin 2008, Pl. 5: 6). In the east a similar shape was discovered at Ančnikovo gradišče (Strmčnik 1997, Pl. 4: 15).

*Date:* Its position of discovery failed to offer any clues for defining its date. Considering the analogies in Koper and Piran we could conclude that they mainly appeared in the 6<sup>th</sup> century. They could be compared to the similarly shaped bowls with a more pronounced carinated wall (Ajdna: Meterc 1981, Pl. 1: 1; Rifnik: Bolta 1981, Pl. 26: 82; Hemmaberg: Ladstätter 2000, Pl. 18: 1–2) which supposedly belong amongst the Lombard influenced forms from the end of the 6<sup>th</sup> and beginning of the 7<sup>th</sup> century (Ladstätter 2000, 148).

*Izdelava:* Izdelana je bila na hitrem lončarskem vretenu in je oksidacijsko (rjavo–rdeče) žgana. Faktura je trda, z dodatkom fino zmletega apnenca.

*Lega:* Posoda je bila najdena v stavbi 1, v plasteh prve poznoantične faze.

*Komentar:* Tako oblika kot faktura predstavljata med keramiko s Tonovcovega gradu izjemo. Morda gre za imitacijo oblike afriške keramike (Bonifay 2004, sl. 145: 7; tudi Fulford, Peacock 1994, sl. 4.2: 26.1–26.3; 4.3: 26.4,26.5), ki je datirana v 4. in prvo polovico 5. st. (Bonifay 2004, 265).

#### Tip 10 (t. 106: 11)

*Oblika:* Skromno ohranjen fragment iz ustja izvlečenega, presegaajočega ročaja z luknjo (t. 106: 11) pripada, sodeč po analogijah, široki konični skledi (Bierbrauer 1987, t. 124: 10) ali kotličku (Lusuardi Siena, Negri, Villa 2004, t. 1: 5–6; 2: 1; 13: 1–2; Pleterski 2008, sl. 1.4: 3; 4.92).<sup>43</sup>

*Velikost:* Ni določljiva.

*Izdelava:* Sleda je bila izdelana v TS 10.

*Okras:* Skleda je preslabo ohranjena, da bi lahko sklepali na okras. Bolje ohranjen primer z Invillina je okrašen z metličnjem in razpotegnjeno valovnico (Bierbrauer 1987, t. 124: 10).

*Lega in datacija:* Fragment je bil najden v žganini na dnu cisterne, skupaj s skoraj celim loncem tipa 6 (t. 106: 12). Sodi v čas po opustitvi cisterne.

*Analogije:* Kozice s presegaajočim prevrtanim ročajem so v Lombardiji in Benečiji značilne za kontekste 9. in 10. st., medtem ko se med poznoantičnim gradivom ne pojavljajo (Lusuardi Siena, Negri, Villa 2004, 88). Primer z Invillina stratigrafsko ni umeščen, saj je bil najden v humusni plasti (Bierbrauer 1987, 380, št. 1174). V zgodnjersrednjeveški plasti je bil najden kotliček v Ratečah (Pleterski 2008, 76).

*Datacija:* Lega na dnu opuščene poznoantične cisterne poleg omenjenih analogij opravičuje datacijo tega fragmenta v čas zgodnjega srednjega veka, natančnejša časovna opredelitev pa ni mogoča.

#### KROŽNIKI IN PEKAČI

Najdeni sta bili dve posodi, ki smo ju zaradi oblike in razmerja med višino in širino ustja (višina ne presega 1/3 širine ustja) lahko uvrstili med krožnike (t. 85: 6; 105: 8). Primer z navzven nagnjenim ustjem (t. 85: 6) ima razmerje med višino in širino celo manjše od 1/7, po čemer bi ga lahko uvrstili med pladnje oziroma pekače (Orton 1980, 33–36). Čeprav se primera tipološko nekoliko razlikujeta, smo ju obravnavali skupaj.

<sup>43</sup> Za pomoč pri opredelitvi se zahvaljujem Andreju Pleterskemu.

#### Type 9 (Pl. 85: 5)

*Form:* This was a deep, in the upper part conically shaped bowl or skillet with a thickened rim that was straightened on the lower edge. The base was ring shaped (Pl. 85: 5). A single example of this shape was found at Tonovcov grad.

*Size:* The bowl measured 15 cm in diameter.

*Manufacture:* This type was made on a fast-spinning pottery wheel and was oxidised (brown – red) fired. The fabric was hard, and included fine crushed limestone particles.

*Position:* The bowl was found in Late Antiquity 1 layers within building 1.

*Commentary:* The shape and fabric represent an exception within the pottery found at Tonovcov grad. It could be an imitation of African pottery (Bonifay 2004, Fig. 145: 7; also Fulford, Peacock 1994, Figs. 4.2: 26.1–26.3; 4.3: 26.4,26.5), dated into the 4<sup>th</sup> and first half of the 5<sup>th</sup> century (Bonifay 2004, 265).

#### Type 10 (Pl. 106: 11)

*Form:* According to analogies the modest handle fragment with a hole, pulled out from the rim (Pl. 106: 11) belongs to a broad conical bowl (Bierbrauer 1987, Pl. 124: 10) or kettle (Lusuardi Siena, Negri, Villa 2004, Pls. 1: 5–6; 2: 1; 13: 1–2; Pleterski 2008, Figs. 1.4: 3; 4.92).<sup>43</sup>

*Size:* Is indeterminable.

*Manufacture:* The bowl was manufactured in TG 10.

*Decoration:* The bowl was not preserved to an extent that would allow us to envisage its decoration. A better preserved example from Invillino was decorated with brush strokes and an elongated wavy line (Bierbrauer 1987, Pl. 124: 10).

*Position and date:* The fragment was discovered in the charcoal at the bottom of the cistern together with an almost complete type 6 pot (Pl. 106: 12). It belongs to the time after the abandoning of the cistern.

*Analogies:* Kettles with an overreaching handle are typical for 9<sup>th</sup> and 10<sup>th</sup> century contexts in Lombardy and Veneto and do not appear in Late Antique material (Lusuardi Siena, Negri, Villa 2004, 88). The example from Invillino was not stratigraphically placed for it was found in the humus layer (Bierbrauer 1987, 380, No. 1174). The kettle from Rateče was found in an Early Medieval layer (Pleterski 2008, 76).

*Date:* Apart from the mentioned analogies the position at the bottom of the Late Antique cistern justifies its dating into the Early Medieval period, however it is impossible to date it with greater precision.

<sup>43</sup> I would like to thank Andrej Pleterski for his help with the classification.

*Oblika:* Krožnik, najden na območju cerkvenega sklopa, ima konično postavljeno ostenje in neodebeljeno ustje (*t. 105: 8*), krožnik iz stavbe 1 (*t. 85: 6*) pa konično ostenje in navzven nagnjeno ustje.

*Velikost:* Premer ustja krožnika iz stavbe 1 je 15 cm, tistega iz cerkvenega sklopa pa 24 cm.

*Izdelava:* Krožnik iz stavbe 1 je močno porozen, mehak in je uvrščen v TS 10. Drugi krožnik je izdelan iz trde, redukcijsko žgane glin, mešane s precej velikimi apnenčevimi delci (TS 6).

*Okras:* Oba krožnika sta bogato okrašena. Ostenje krožnika na *t. 105: 8* je na zunanji strani žlebljeno, tik pod ustjem je valovnica. Tudi pri krožniku *t. 85: 6* je okrašena praktično cela vidna površina posode: ostenje je na zunanji strani razčlenjeno z žlebovi, med njimi je valovnica. Z valovnico je okrašena tudi notranja, izvihanana stran ustja.

*Lega:* Primer z ravnim koničnim ostenjem (*t. 105: 8*) je bil najden je na prostoru med osrednjo in južno cerkvijo, primer z navzven nagnjenim ustjem (*t. 85: 6*) pa v okolici stavbe 1. Oba sta bila najdena v plasteh druge poznoantične faze.

*Analogije:* Krožniki z ravnim ostenjem so poznani z Oderza (Castagna, Spagnol 1996, t. 4: 54), Ajdne (Meterc 1981, t. 2: 10), Rifnika (Bolta 1981, t. 24: 70), s Tinja (Ciglencečki 2000, t. 26: 10), iz škofovske cerkve v Teurniji (Rodriguez 1990, t. 2: 15; 1997, t. 1: 9), s Sv. Heme (Ladstätter 2000, t. 18: 4; 57: 6), Duela (Steinklauber 1988, t. 40: 3) in Kappel (Felgenhauer-Schmiedt 1993: t. 14: 4–6). Večina jih je grobo izdelanih (Ladstätter 2000, 149–150) in okrašenih.

Najbližja analogija za krožnik z izvihanim ustjem (*t. 85: 6*) je na Invillinu (Bierbrauer 1987, t. 133: 4), kjer je ravno tako okrašen z valovnico in žlebljenjem. Na ostalih obravnavanih najdiščih takšna oblika ni poznana, so pa bili podobni pekači najdeni na območju osrednje Italije (Patterson, Roberts 1998, sl. 8: 13–14; Patterson et al. 2005, sl. 12: 6–7).

*Datacija:* Večina naštetih primerov ni jasno stratigrafsko umeščeni. Primer iz Oderza izvira iz konteksta 8.–9. st. (Castagna, Spagnol 1996, 88; Lusuardi Siena, Negri, Villa 2004, 80–83).

Na območju osrednje Italije severno od Rima so podobni pekači datirani v konec 6., predvsem pa v 7. in 8. st. in jih povezujejo z langobardsko okupacijo, ki prekine povezavo tega območja z Rimom (Patterson, Roberts, 1998, 432, sl. 8: 13–14).

V obdobju zgodnjega srednjega veka se pekači pojavljajo tudi med slovanskim gradivom, kjer sodijo med najbolj tipične oblike (npr. Kotare – baza: Kerman 2002, št. 8; Nova tabla: Guštin, Tiefengraber 2002, 48, sl. 4: 1–5). Ti pekači so zelo grobo izdelani, neokrašeni ter se tako zelo razlikujejo od primerov s Tonovcovega gradu.

Čprav naših krožnikov ne moremo neposredno povezati ne s slovanskim ne z osrednjeitalijanskim gradivom, vendarle kaže, da gre za dokaj pozno obliko,

## PLATES AND BAKING TRAYS

Due to their shape and the ratio between the height and width of the rim (the height does not surpass 1/3 of the rim's width) two vessels have been classified as plates (*Pls. 85: 6; 105: 8*). The height vs. width ratio in the example with the outward leaning rim (*Pl. 85: 6*) is below 1/7, which could place it amongst platters or baking trays (Orton 1980, 33–36). Even though the examples are typologically somewhat different we treated them together.

*Form:* The plate found in the ecclesiastical complex had a conical wall and a non-thickened rim (*Pl. 105: 8*), while the plate from building 1 (*Pl. 85: 6*) had a conical wall and an outward leaning rim.

*Size:* The diameter of the rim from building 1 measured 15 cm, while that one from the ecclesiastical complex measured 24 cm.

*Manufacture:* The plate from building 1 is strongly porous, soft, made from TG 10. The second plate is produced from hard, reduced fired clay, mixed with rather large limestone particles (TG 6).

*Decoration:* Both plates were richly ornamented. The wall on plate *Pl. 105: 8* was grooved on the outer side, and had a wavy line right below the rim. Almost the entire visible surface of plate *Pl. 85: 6* was decorated: the outer side of the walls were covered in grooves, with a wavy line amongst them. A wavy line also appeared on the inner, everted side of the rim.

*Position:* The example with the straight conical wall (*Pl. 105: 8*) was discovered in the area between the main and south church, while the example on *Pl. 85: 6* was discovered in the vicinity of building 1. Both were discovered in Late Antiquity 2 layers.

*Analogies:* Plates with straight walls were discovered at Oderzo (Castagna, Spagnol 1996, Pl. 4: 54), Ajdna (Meterc 1981, Pl. 2: 10), Rifnik (Bolta 1981, Pl. 24: 70), Tinje (Ciglencečki 2000, Pl. 26: 10), the episcopal church in Teurnia (Rodriguez 1990, Pl. 2: 15; 1997, Pl. 1: 9), Hemmaberg (Ladstätter 2000, Pls. 18: 4; 57: 6), Duell (Steinklauber 1988, Pl. 40: 3) and Kappel (Felgenhauer-Schmiedt 1993: Pl. 14: 4–6). Most of them were coarsely manufactured and decorated.

The closest analogy for the plate with the everted rim (*Pl. 85: 6*) was found at Invillino (Bierbrauer 1987, Pl. 133: 4), where it was also decorated with a wavy line and grooves. None of the other discussed sites revealed this shape, however similar baking trays were discovered in central Italy (Patterson, Roberts 1998, Fig. 8: 13–14; Patterson et al. 2005, Fig. 12: 6–7).

*Date:* Most of the examples were not stratigraphically placed. The example from Oderzo originates from a 8<sup>th</sup> or 9<sup>th</sup> century context (Castagna, Spagnol 1996, 88; Lusuardi Siena, Negri, Villa 2004, 80–83).

North of Rome, in central Italy, similar baking trays were dated into the end of the 6<sup>th</sup>, and into the 7<sup>th</sup> and 8<sup>th</sup> century. These trays were linked to the Lombard oc-

ki je pred drugo polovico 6. st. med grobo keramiko ne zasledimo. Izdelava krožnika s koničnim ostenjem kaže še poznoantične značilnosti, medtem ko bi bil krožnik z izvihanim ustjem zaradi grobe fature lahko tudi kasnejši.

#### POKROVI IN PEKVE

Pokrove in pekve je velikokrat težko razločevati od skled. Posebno pri velikih skledah tipa 1 je dokaj verjetno, da so bile uporabljene tudi za pekve. Tako uporabo dokazujejo tudi primeri z ohranjenim držajem ali preluknjanim ostenjem, ki so bili najdeni npr. v Koprju (Cunja 1996, t. 38: 398–400). Na Tonovcovem gradu ni bil najden noben primer, ki bi imel ročaj ali preluknjano ostenje, zato smo se odločili za uvrstitev med sklede.

Med pokrove so na Tonovcovem gradu uvrščene oblike z rahlo ali izrazito zvončastim ostenjem ter ravnim ali rahlo izvihanim ustjem majhnega premera (t. 86: 1–4; 104: 9), čeprav imajo tudi ti primeri lahko dvojno funkcijo, kar kaže tudi nemški izraz *Deckelschale* (Rodriguez 1997, 154; Ladstätter 2000, 150). Analogije zanje najdemo po vsem jugovzhodnoalpskem in severnojadranskem prostoru. Najdene so bile v Koprju (Cunja 1996, t. 36: 381–390), Hrušici (Giesler 1981, t. 48: 26), Kučarju (kot skleda – J. Dular, Ciglencečki, A. Dular 1995, t. 82: 6), Ajdni (Ciglencečki 2000, sl. 124: 7), Vranju (Mirnik-Prezelj 1984, t. 26: 246), Sv. Hemi (Ladstätter 2000, t. 18: 7–8; Rodriguez 1997, t. 3: 18–21), na Šenturški gori (Rodriguez 1997, t. 5: 37,39) in Kirchbichlu (Rodriguez 1997, t. 11: 102–103).

Od ostalih, med pokrove uvrščenih primerov dokaj izstopata posodi t. 86: 5–6, pri katerih je ravno tako možna uporaba tudi za sklede. Posodi oziroma pokrova sta zelo podobne oblike, okrasa in fature (obe pripadata tehnološki skupini 8). Ostenje je rahlo kroglasto, tik pod ustjem je rebro, ki se razširi v držaj. Obe sta bili najdeni v SE 50, to je v plasti, ki pripada zadnjemu obdobju druge poznoantične faze, torej času druge polovice 6. st.

#### LONCI

**Tip 1** (t. 87–88; 89: 1–14; 102: 6,8; 103: 8–10; 105: 9–10)

*Oblika:* To so lonci s kratkim ali srednje dolgim, izvihanim, neodebeljenim ustjem. Vrat je kratek, usločen in dokaj ostro prehaja v rame, te pa položno v kroglast trup. Ustje je lahko postavljeno izrazito pokončno (t. 87: 1), ali pa nekoliko bolj položno. Cele oblike v nobenem primeru ni bilo mogoče rekonstruirati, gre pa za dokaj kroglaste lonce, kjer premer trebuha presega premer ustja. Pri nekaterih primerih (predvsem pri manjših loncih) je opazno stanjšanje ostenja na trebušnem delu lonca (t. 87: 1,3,5). To je najštevilčnejši tip loncev na Tonovcovem gradu.

Po zaključku ustja lahko ločimo dve varianti:

cupation which cut off the connection between this area and Rome (Patterson, Robert, 1998, 432, Fig. 8: 13–14).

In the Early Medieval period baking trays appear to be a common shape amongst the Slavic pottery (cf. Kotare – baza: Kerman 2002, No. 8; Nova tabla: Guštin, Tiefengraber 2002, 49, Fig. 4: 1–5). They are coarse in their manufacture, are not decorated and are thus very different from the examples from Tonovcov grad.

Even though we cannot directly link our plates to the Slavic or central Italian materials, it seems that it is a relatively late form that was not present before the second half of the 6<sup>th</sup> century. The manufacturing of the plate with conical walls showed Late Antique characteristics, however regarding the fabric the plate with the everted rim could be of later origin.

#### LIDS AND FIRE COVERS

It is often hard to distinguish lids and fire covers from bowls. It is especially likely for type 1 large bowls to be also used as fire covers. Such use is also indicated by the examples with the preserved handle or holed walls that were found in Koper (Cunja 1996, Pl. 38: 398–400). At Tonovcov grad no examples with a handle or a holed body were found, thus we decided to categorise them amongst bowls.

On Tonovcov grad the forms with a slightly or explicitly bell-shaped body and a straight or slightly everted rim with a small diameter were categorised as lids (*Pls.* 86: 1–4; 104: 9), even though the German term *Deckelschale* (Rodriguez 1997, 154; Ladstätter 2000, 150) clearly indicates that they can have a double function. Analogies can be found across the entire Southeastern Alps and the northern Adriatic. They were found in Koper (Cunja 1996, Pl. 36: 381–390), Hrušica (Giesler 1981, Pl. 48: 26), Kučar (as a bowl – J. Dular, Ciglencečki, A. Dular 1995, Pl. 82: 6), Ajdna (Ciglencečki 2000, Fig. 124: 7), Vranje (Mirnik-Prezelj 1984, Pl. 26: 246), Hemmaberg (Ladstätter 2000, Pl. 18: 7–8; Rodriguez 1997, Pl. 3: 18–21), Ulrichsberg (Rodriguez 1997, Pl. 5: 37,39) and Kirchbichel (Rodriguez 1997, Pl. 11: 102–103).

From the remaining vessels categorised as lids examples *Pl.* 86: 5–6 stand out, for they could also be used as bowls. Both of the vessels or lids are of a similar shape, decoration and fabric (both belong to technological group 8). The walls were slightly rounded and just below the rim stood a rib that widened into a handle. Both were found in SU 50, i.e. in a layer that belongs to the last period of the Late Antiquity 2 phase, i.e. the second half of the 6<sup>th</sup> century.

#### POTS

**Type 1** (*Pls.* 87–88; 89: 1–14; 102: 6–8; 103: 8–10; 105: 9–10)

*Form:* It consists of pots with a short or medium length and everted and non-thickened rim. The neck



1a: Rob ustja je ravno odrezan (t. 87–88; 103: 8–10), včasih žlebljen (t. 87: 1–2,4).

1b: Rob ustja je zaobljen (t. 89: 1–14; 102: 6,8; 105: 9–10), lahko rahlo žlebljen (t. 89: 5–6).

*Velikost:* Zastopane so velikosti od zelo majhnih (premer ustja 8 cm) lončkov do srednje velikih loncev s premerom 22 cm.

*Izdelava:* Večina loncev je izdelanih kvalitetno, iz trde, dobro prečiščene glin, v večini primerov so žgani redukcijsko, pojavlja pa se tudi oksidacijsko žganje in žganje v nekontrolirani atmosferi.

*Okras:* Lonci tipa 1 so pogosto okrašeni. Med okrasom prevladuje valovnica. Največkrat se pojavlja več enojnih (t. 87: 7; 88: 1,3,8; 103: 10), ki so lahko tudi prepletene (t. 87: 8), kombinirane z metličanjem ali glavničanjem (t. 87: 1,6; 88: 3), horizontalnim vrezom (t. 87: 8; 88: 8) ali linijami kratkih poševnih vrezov (t. 87: 8; 89: 13). V dveh primerih je valovnica večlinijska in kombinirana z metličanjem (t. 89: 1,6). Dokaj pogost okras tega tipa loncev so tudi linije kratkih poševnih vrezov pod ustjem posode (t. 87: 3,8; 88: 9–10,14; 89: 3).

*Lega:* Pojavljajo se že v plasteh prve poznoantične faze (t. 87: 1,11; 88: 2; 89: 1,9–10), največ pa jih je bilo najdenih v plasteh druge poznoantične faze. Dva primera iz zgodnesrednjeveških plasti (t. 87: 2,5) lahko zaradi podobnosti njihove oblike in fature s poznoantičnimi opredelimo kot residualna kosa.

*Analogije:* Gre za široko razprostranjen tip, ki je razširjen na vsem jugovzhodnoalpskem prostoru. Na Invillinu imajo analogije v nekaterim oblikah loncev tipov III a2 in III a3 (Bierbrauer 1987, t. 73: 8,11; 79: 13–16,18,20; 83: 5; 85: 6–7; 96: 14,18; 100: 17,19; 106: 15–16,18; 110:17; 118: 2,7–8), tisti z žlebljenim robom tudi III b (Bierbrauer 1987, t. 72: 8–11; 118: 2,8).<sup>44</sup> Poznani so tudi z drugih furlanskih najdišč, najdeni so bili na Castelraimundu (Covizzi 1995, t. 6: C 2404, C 1752), v Vidmu (Buora, Fasano 1994, t. 2: III a1, III a2, III b) in Akvileji (Rupel 1994, t. 26: CCg 7).

Dokaj pogosti so lonci tega tipa na najdiščih slovenskega Primorja in sicer tako na obali, kot v zaledju. Tako so bili najdeni na Kapucinskem vrtu v Koprju (Cunja 1996, t. 31: 338–345; 31: 340–343,345; 32: 346–348; 33: 354,356),<sup>45</sup> kjer jih povezuje s Tonovcovim gradom tudi značilno stanjšanje stene trebušnega dela, vendar v Koprju prevladujejo neokrašeni lonci, le v redkih primerih zasledimo okras enojne valovnice. Najdeni so bili tudi v Predloki (Boltin-Tome 1993, t. 2: 3,5; t. 3: 6–7), Piranu (Vidrih Perko 1994a, sl. 5: 2–5; Snoj, Novšak 1992, t. 3: 2), na Rodiku (Ciglencečki 2000, sl. 115: 1–2), Križni gori (Ciglencečki 2000, sl. 105: 2–3,5,11–12), Martinj hribu

was short and turned relatively sharply into the shoulder which continued into the rounded body. The rim could be explicitly vertical (Pl. 87: 1), or slightly more gradual. The entire shape could not be reconstructed, however we know they were relatively rounded pots, at which the diameter of the body surpassed the rim diameter. In some cases (especially in smaller pots) the pot body walls were thinned (Pl. 87: 1,3,5). This was the most numerous pot type at Tonovcov grad.

Two variants were ascertained according to the rim edge:

1a: The rim edge was cut off in a straight line (Pls. 87-88; 103: 8-10), sometimes grooved (Pl. 87: 1-2,4).

1b: The rim edge was rounded (Pls. 89: 1-14; 102: 6,8; 105: 9-10) and could be slightly grooved (Pl. 89: 5-6).

*Size:* Sizes range from very small (rim diameter 8 cm) pots to medium sized pots (rim diameter 22 cm).

*Manufacture:* Most pots were of high quality, made from hard, purified clay. Most of them were reduced fired, however examples that were oxidised fired or fired in an uncontrolled atmosphere were also found.

*Decoration:* Type 1 pots were often decorated. The wavy line was the most commonly found decoration. Most popular were multiple single lines (Pls. 87: 7; 88: 1,3,8; 103: 10), that could be intertwined (Pl. 87: 8), combined with brush strokes or combing (Pls. 87: 1,6; 88: 3), horizontal incisions (Pls. 87: 8; 88: 8) or short slanting incisions (Pls. 87: 8; 89: 13). In two examples the wavy line was multiple and combined with brush strokes (Pl. 89: 1,6). Short slanting incisions under the rim were also a relatively commonly found decoration within this type (Pls. 87: 3,8; 88: 9-10,14; 89: 3).

*Position:* They appear already in Late Antiquity 1 layers (Pls. 87: 1,11; 88: 2; 89: 1,9-10), however most of them were discovered in Late Antiquity 2 layers. Two examples from Early Medieval layers (Pl. 87: 2,5) were – due to their similarity in shape and fabric with Late Antique examples – defined as residual pieces.

*Analogies:* This was a widely spread type known throughout the Southeastern Alps. At Invillino analogies were found in some forms of pots types III a2 and III a3 (Bierbrauer 1987, Pls. 73: 8,11; 79: 13-16,18,20; 83: 5; 85: 6-7; 96: 14,18; 100: 17,19; 106: 15-16,18; 110: 17; 118: 2,7-8), while those with a grooved edge had analogies in III b (Bierbrauer 1987, Pls. 72: 8-11; 118: 2,8).<sup>44</sup> They were also found in other sites in Friuli, they were discovered on Castelraimondo (Covizzi 1995, Pl. 6: C 2404, C 1752), in Udine (Buora, Fasano 1994, Pl. 2: III a1, III a2, III b) and Aquileia (Rupel 1994, Pl. 26: CCg 7).

This pot type was relatively common in sites on the Slovenian coast and its hinterland. Thus they were found in Kapucinski vrt in Koper (Cunja 1996, Pls. 31: 338-345; 31:

<sup>44</sup> V tipa III a2 in III a3 so sicer uvrščeni tudi lonci, ki imajo daljše ustje in bolj izrazit vrat (Bierbrauer 1987, t. 73: 5–14). Pri naši razdelitvi smo te lonce obravnavali kot posebna tipa.

<sup>45</sup> Za analogije na ostalih istrskih in severnojadranskih najdiščih Cunja 1996, op. 453, 454.

<sup>44</sup> Types III a2 and III a3 include pots with a long rim and a pronounced neck (Bierbrauer 1987, Pl. 73: 5-14). In our classification we treated them as special types.

(Leben, Šubic 1990, t. 10: 160–163, 179–181; 11: 182–184, 187, 190–193; 12: 207). Zelo pogosti so na Hrušici (Giesler 1981, t. 46; 47: 5,7), kjer so večinoma okrašeni z glavničenjem. V osrednji in vzhodni Sloveniji so bili najdeni na Korinjskem hribu (Ciglencečki 1985, t. 6: 69), Kučarju (J. Dular, Ciglencečki, A. Dular 1995, t. 79: 6–7; 82: 9), Ajdni (Meterc 1981, t. 2: 6,8; Ciglencečki 2000, sl. 123: 2–3,5,7), Ančnikovem gradišču (Strmčnik 1997, t. 4: 1–11; 6: 17; Ciglencečki 2000, sl. 98: 4), Brinjevi gori (Ciglencečki 2000, sl. 93: 11; 94: 6–7) in Rifniku (Ciglencečki 2000, sl. 83: 4). Na Tinju ustrezajo nekaterim oblikam tipov 2 in 3 (Ciglencečki 2000, sl. 78: 2; t. 13: 11; 14: 5–7; 15: 4–9; 16: 1–3).

Na Sv. Hemi lonci tega tipa sodijo med najpogostejše oblike, postavljeni so v tip 1, variante 2, 3 in 4 (Ladstätter 2000, 135–136, t. 10: 4–6; 11: 1–5), en primer z izrazito kratkim ustjem pa v tip 4 (Ladstätter 2000, t. 12: 7).<sup>46</sup> En primer z žlebljenim robom (Ladstätter 2000, t. 51: 1) je ohranjen cel in kaže močno kroglasto obliko, je tudi bogato okrašen. Najdeni so bili tudi na Šenturški gori (Rodriguez 1997, t. 5: 38,40–42,44) in Teurniji – škofovska cerkev (Rodriguez 1997, t. 1: 1–2,4). Lonci variante b so pogosti na Duelu, kjer so pogosto okrašeni z žlebom na robu ustja (Steinklauber 1990, sl. 5–8). Take oblike na Duelu nastopajo tudi kot vrčki z enim ročajem (Steinklauber 1990, sl. 2: 2–6; 4).

*Daticija:* Na vseh jugovzhodnoalpskih in severno-jadranskih najdiščih so zelo dolgotrajna oblika, saj so pogosti že v 4. st. Okrašeni z glavničenjem po celi površini posode se pojavljajo na Hrušici (Giesler 1981, t. 46). V 5. st. se kot značilen element okrasa pojavi valovnica, v teku 6. st. pa naj bi bila opazna tendenca k bolj nizkim oblikam s širokim dnom. Tovrstni lonci so po pravilu bogato okrašeni, zanje je značilna tudi bolj groba izdelava in neenakomerno izvedene valovnice (Ladstätter 2000, 137–138).<sup>47</sup>

Lonci s Tonovcovega gradu kažejo dokajšnjo sorodnost s tistimi iz Kopra, kjer se pojavljajo v kontekstih, ki so na podlagi uvožene keramike datirani v čas 5.–7. st. (Cunja 1996, 125). V 5. st. lahko, glede na čas trajanja obeh naselbin, postavimo tudi primere iz Rodika in Kučarja. Na Sv. Hemi so na podlagi stratigrafskih kontekstov ravno tako datirani v 5. st. (Ladstätter 2000, 138–139). Ciglencečki poudarja široko razširjenost loncev tega tipa v širokem časovnem intervalu, saj naj bi se pojavljali tako v izrazito poznoantičnih kontekstih kot tudi v kasnejših obdobjih (Ciglencečki 2000, 64–65).

<sup>46</sup> Lonci s kratkim izvihanim ustjem so uvrščeni v tip 4, v katerega pa postavlja le lonce z največjim premerom v spodnji polovici posode, ne pa tudi izrazito trebušastih loncev (Ladstätter 2000, 138, t. 12: 7). Citat za Duel – Steinklauber 1990, sl. 14 je napačen, verjetno sl. 15). Na Sv. Hemi je našim podobnih tudi nekaj lončkov, uvrščenih v skupino lončik-vrči (tip 1, Ladstätter 2000, 140, t. 13: 4).

<sup>47</sup> Na sv. Hemi so v času druge polovice 6. st. edina oblika loncev (Ladstätter 2000, 137), kar je v nasprotju s tezo V. Bierbrauerja, da oblike loncev v periodu III močno varirajo (Bierbrauer 1987, 208).

340–343,345; 32: 346–348; 33: 354,356)<sup>45</sup> where they were linked to Tonovcov grad also by their characteristic narrowing of their body walls, however in Koper undecorated pots prevailed, and only a few examples had a single wavy line decoration. They were discovered also in Predloka (Boltintome 1993, Pls. 2: 3,5; 3: 6–7), Piran (Vidrih Perko 1994a, Fig. 5: 2–5; Snoj, Novšak 1992, Pl. 3: 2), at Rodik (Ciglencečki 2000, Fig. 115: 1–2), Križna gora (Ciglencečki 2000, Fig. 105: 2–3,5,11–12), Martinj hrib (Leben, Šubic 1990, Pls. 10: 160–163,179–181; 11: 182–184, 187,190–193; 12: 207). This type was very common at Hrušica where most of them were decorated with combed decoration (Giesler 1981, Pl. 46; 47: 5,7). In the central and east part of Slovenia they were discovered at Korinjski hrib (Ciglencečki 1985, Pl. 6: 69), Kučar (J. Dular, Ciglencečki, A. Dular 1995, Pl. 79: 6–7; 82: 9), Ajdna (Meterc 1981, Pl. 2: 6,8; Ciglencečki 2000, Fig. 123: 2–3,5,7), Ančnikovo gradišče (Strmčnik 1997, Pls. 4: 1–11; 6: 17; Ciglencečki 2000, Fig. 98: 4), Brinjeva gora (Ciglencečki 2000, Figs. 93: 11; 94: 6–7) and Rifnik (Ciglencečki 2000, Fig. 83: 4).

On Tinje they corresponded to some type 2 and 3 shapes (Ciglencečki 2000, Fig. 78: 2; Pls. 13: 11; 14: 5–7; 15: 4–9; 16: 1–3).

On Hemmaberg this was one of the most commonly found types. The examples were placed in type 1, variants 2, 3 and 4 (Ladstätter 2000, 135–136, Pls. 10: 4–6; 11: 1–5), and one example with an extremely short rim into type 4 (Ladstätter 2000, Pl. 12: 7).<sup>46</sup> One richly decorated example with a grooved edge was preserved in its entirety and shows a strongly rounded shape (Ladstätter 2000, Pl. 51: 1). Similar examples were also found on Ulrichsberg (Rodriguez 1997, Pl. 5: 38,40–42,44) and in the episcopal church in Teurnia (Rodriguez 1997, Pl. 1: 1–2,4). Variant b pots were common at Duel, where the rim edge was often decorated with a groove (Steinklauber 1990, Figs. 5–8). These forms also appeared at Duel as jugs with a single handle (Steinklauber 1990, Figs. 2: 2–6; 4).

*Date:* This was a long-lasting form throughout the Southeastern Alps and the North Adriatic, for it was common already in the 4<sup>th</sup> century. Combed decoration across the entire surface appears at Hrušica (Giesler 1981, Pl. 46). In the 5<sup>th</sup> century the wavy line appeared as a characteristic decorative element, and during the 6<sup>th</sup> century a tendency to lower the forms with a broader base was noticed. As a rule such pots were richly decorated, coarsely made and had uneven wavy lines (Ladstätter 2000, 137–138).<sup>47</sup>

<sup>45</sup> For analogies at other Istrian and North Adriatic sites see Cunja 1996, notes 453, 454.

<sup>46</sup> Pots with a short everted rim were placed into type 4, which consists merely of pots with the largest diameter in the lower part of the pot, but not also pots with a pronounced body (Ladstätter 2000, 138, Pl. 12: 7. Quote for Duel – Steinklauber 1990, Fig. 14 is wrong, most likely Fig 15.). On Hemmaberg a few small pots resembled our pots, and they were classified in the group small pots – jugs (type 1, Ladstätter 2000, 140, Pl. 13: 4).

<sup>47</sup> In the second half of the 6<sup>th</sup> century this was the only

**Tip 2** (*t. 89: 15; 90: 1-7; 102: 7,9*)

*Oblika:* Sem so uvrščeni lonci z izvihanim, na zunanji strani izbočenim ustjem, ki je na notranji strani izrazito ali rahlo usločeno in tvori ležišče za pokrov. Ustje brez izrazitega vratu prehaja v trup, ki je pri ohranjenih primerih trebušast (*t. 89: 15; 90: 1*). Nekateri primeri, ki imajo rahlo spodrezan zunanji rob ustja (*t. 90: 5,7*), se približujejo tipu 5.

*Velikost:* To so srednje veliki lonci s premerom med 15 in 20 cm.

*Izdelava:* Opaziti ni nobenih zakonitosti.

*Okras:* En lonec je okrašen z valovnico in metličenjem (*t. 90: 1*), eden samo z večlinijsko vlovnico (*t. 90: 3*), ostali pa so okrašeni samo z metličenjem ali so neokrašeni.

*Lega:* Na Tonovcovem gradu se pojavljajo večinoma v plasteh prve poznoantične faze (*sl. 4.12*). V drugo poznoantično fazo sodita le lonec *t. 89: 16* in skoraj v celoti ohranjen lonec nizke, trebušaste oblike, okrašen z metličenjem in dvojno, dokaj nepravilno izvedeno valovnico (*t. 90: 1*). Od drugih loncev tega tipa se loči predvsem po izrazito trebušasti obliki in široki stojni ploskvi.

*Analogije:* V jugovzhodnih Alpah niso zelo pogosti, značilni naj bi bili za zahodnonoriško območje (Ladstätter 2000, 138-139, op. 847). V osrednji Sloveniji je podoben lonec poznan z Ajdne (Ciglencečki 2000, sl. 123: 6). Na Sv. Hemi ustrezajo tipu 5 (Ladstätter 2000, 138, t. 12: 8-9), poznani so tudi z Lavanta (Rodriguez 1997, t. 10: 97).

*Datacija:* Večino loncev tipa 2 na Tonovcovem gradu lahko na podlagi njihovega stratigrafskega položaja postavimo v drugo polovico 4. in prvo polovico 5. st., lonec *t. 90: 1* pa kaže razvoj v nižje, bolj trebušaste oblike v 6. st.

**Tip 3** (*t. 90: 8; 91: 1-5; 102: 10; 105: 11*)

*Oblika:* V tej skupini so združeni lonci s poševno izvihanim, na zunanji strani odebeljenim ustjem, ki je od vratu ločeno z izrazitim robom. Notranji rob ustja je izbočen (*t. 90: 6; 91: 1-3*) ali raven (*t. 91: 4-5*), v tem primeru se približujejo tipu 2. Lonci so večinoma ohranjeni samo v zgornjem delu, tako da celotne oblike ni mogoče rekonstruirati.

*Velikost:* Lonci so majhni do srednje veliki.

*Izdelava:* Vsi lonci tega tipa so izdelani kvalitetno. So večinoma oksidacijsko žgani. Prevladujeta tehnološki skupini 1 in 2, pojavlja pa se še skupina 8.

*Okras:* Ker je večinoma ohranjen samo del ustja in vratu, o okrasu ne moremo povedati nič določenega. Rob ustja je lahko žlebljen (*t. 91: 5; 102: 10*).

*Lega:* Lonci tega tipa so bili na Tonovcovem gradu najdeni v plasteh prve druge poznoantične faze.

Pots from Tonovcov grad were relatively similar to those found in Koper, where they appeared in contexts that were dated with the use of imported pottery between the 5<sup>th</sup> and 7<sup>th</sup> century (Cunja 1996, 125). If we take into account the period in which the two settlements were inhabited the examples from Rodik and Kučar can also be dated into the 5<sup>th</sup> century. The stratigraphic contexts on Hemmaberg date them into the 5<sup>th</sup> century (Ladstätter 2000, 138-139). Ciglencečki emphasised that this pot type was widely spread across a long period, for they appeared in clear Late Antique contexts as well as in later periods (Ciglencečki 2000, 64-65).

**Type 2** (*Pls. 89: 15; 90: 1-7; 102: 7,9*)

*Form:* This group includes pots with an everted rim, convex on the outer side, and distinctively or slightly concave on the inner side, thus forming a place for the lid. The rim continues to flow into the body, which is within all of the preserved examples spherical, without a pronounced neck (*Pls. 89: 15; 90: 1*). Some examples with a slightly undercut outer rim edge (*Pl. 90: 5,7*) resemble type 5.

*Size:* These medium sized pots had a diameter measuring between 15 and 20 cm.

*Manufacture:* No special characteristics were noticed.

*Decoration:* One pot was decorated with a wavy line and brush strokes (*Pl. 90: 1*), one with multiple wavy lines (*Pl. 90: 3*), and the rest with brush strokes or they were undecorated.

*Position:* Most examples at Tonovcov grad were found in Late Antiquity 1 layers (*Fig. 4.12*). Pot *Pl. 89: 16* and the almost entirely preserved low and spherical pot, decorated with brush strokes and a double, rather irregularly created wavy line (*Pl. 90: 1*), were the only ones to be dated to Late Antiquity 2. This pot differs from the others in this type by its distinctive spherical shape and the wide standing base.

*Analogies:* In the Southeastern Alps they were not very common, however they were believed to be characteristic of west Noricum (Ladstätter 2000, 138-139, note 847). In central Slovenia a similar pot was found on Ajdna (Ciglencečki 2000, Fig. 123: 6). On Hemmaberg they corresponded to type 5 (Ladstätter 2000, 138, Pl. 12: 8-9), and they were also found at Lavant (Rodriguez 1997, Pl. 10: 97).

*Date:* On the basis of their stratigraphic position most type 2 pots on Tonovcov grad were dated into the second half of the 4<sup>th</sup> and first half of the 5<sup>th</sup> century, while pot *Pl. 90: 1* showed a development into the lower, spherical shaped form in the 6<sup>th</sup> century.

pot type at Hemmaberg (Ladstätter 2000, 137). This is in contradiction to V. Bierbrauer's thesis, who stated that there were great variations in III period pot shapes (Bierbrauer 1987, 208).

*Analogije:* Na Invillinu ustrezajo nekaterim oblikam III c2 (Bierbrauer 1987, t. 74: 6–8; 119: 13–14), poznani so še iz Akvileje (Rupel 1994, t. 27: CCg 14) in Vidulisa (Rupel 1988, št. 16–17). Na Sv. Hemi ustrezajo tipu 3 (Ladstätter 2000, 138, t. 12: 1–6).<sup>48</sup>

*Datacija:* Glede na njihov stratigrafski položaj jih lahko postavimo v čas druge polovice 4. in začetka 5. st., čemur ustrezajo tudi analogije na furlanskih (Vidulis, Akvileja) in koroških (Sv. Hema) najdiščih.

#### Tip 4 (t. 91: 6–18; 92; 93: 1–7)

*Oblika:* To so lonci s kratkim, dokaj pokončno postavljenim ustjem, ki je razširjeno in na spodnjem robu spodrezano (t. 91: 6–18; 92; 93: 1–7). Rob ustja je postavljen navpično ali pa nagnjen poševno navzven ali navznoter. Notranja stran ustja je ravna, brez utora za pokrov. Vrat prehaja v strmo postavljene rame.

Ločimo dve varianti:

4a: Ustje je izrazito razširjeno in spodrezano (t. 91: 6–18).

4b: Ustje je samo rahlo razširjeno in spodrezano (t. 92; 93: 1–7). V tem primeru se oblika ustja lahko približuje tipu 2, vendar je ustje pri tipu 4 bolj kratko in pokončno postavljeno.

*Velikost:* Prevladujejo majhni lonci, nekaj je tudi srednje velikih, izrazito velikih loncev pa ni.

*Izdelava:* Opaziti ni nobenih zakonitosti.

*Okras:* Tudi pri tej obliki zaradi slabe ohranjenosti težko sklepamo na okras. Lonci variante 4a imajo lahko žlebljeno ustje (t. 91: 14,18). V nekaj primerih je z globokimi žlebovi okrašeno tudi ostenje tik pod ustjem (t. 91: 15,18), žlebljenje pa se lahko pojavlja tudi na notranji strani posode. Med lonci variante 4b izstopa lonček t. 93: 7, okrašen s tremi nizi enojnih valovnic, ki so ločene s kaneluro. Okras valovnice se v enem primeru (t. 93: 1) pojavlja tudi na notranji strani ustja.

*Lega:* Na Tonovcovem gradu njihovo pojavljanje v plasteh prve poznoantične faze ni popolnoma zanesljivo (SE 24, kjer so zelo pogosti, vsebuje mešano gradivo faz PA 1 in PA 2), prevladujejo pa v drugi poznoantični fazi, torej v 6. st. Redki so v zgodnjerednjeveških plasteh (sl. 4.12).

*Analogije:* Tipu najdemo bližnje in zelo številne analogije na Invillinu. Varianta 4a ustreza predvsem tipu III d2 (z navpično postavljenim robom ustja, Bierbrauer 1987, t. 75: 6–15), nekateri primeri tudi tipu III d3 (z izrazito poševno postavljenim robom ustja, Bierbrauer 1987, t. 76: 1–2) in tipu III e (z izrazito pokončno postavljenim vratom, Bierbrauer 1987, t. 74: 12–17). Lonci te variante so poznani še iz Pirana (Vidrih Perko 1994a, sl. 5: 8), Sv. Pavla (Svoljšak 1985, t. 1: 15, 3: 50), Akvileje (Rupel 1994, t. 3: CCg 42–44). Nekaterne oblike (t. 31:

#### Type 3 (Pls. 90: 8; 91: 1-5; 102: 10; 105: 11)

*Form:* This group includes all pots with an obliquely everted rim, thickened on the outer side, and separated from the neck by a pronounced edge. The inner edge of the rim is convex (Pls. 90: 6; 91: 1-3) or straight (Pl. 91: 4-5), in this case they come close to type 2. In most cases only the upper parts of the pots were preserved, thus it was impossible to reconstruct the entire shape.

*Size:* The size ranges from small to medium.

*Manufacture:* All pots made in this type were of high quality. Most of them were oxidised fired. Technological groups 1 and 2 were the most common, but group 8 was also used.

*Decoration:* In most cases only a part of the rim and the neck were preserved, thus it was impossible to determine its decoration. In some cases the rim edge was grooved (Pls. 91: 5; 102: 10).

*Position:* At Tonovcov grad this type was found in Late Antiquity 1 and Late Antiquity 2 layers.

*Analogies:* At Invillino they correspond to some III c2 forms (Bierbrauer 1987, Pls. 74: 6-8; 119: 13-14), and they were also found in Aquileia (Rupel 1994, Pl. 27: CCg 14) and Vidulis (Rupel 1988, Nos. 16-17). On Hemmaberg they correspond to type 3 (Ladstätter 2000, 138, Pl. 12: 1-6).<sup>48</sup>

*Date:* Taking their stratigraphic position into account they can be placed into the second half of the 4<sup>th</sup> and beginning of the 5<sup>th</sup> century, which fits in nicely with the analogies in Friuli (Vidulis, Aquileia) and Carinthia (Hemmaberg).

#### Type 4 (Pls. 91: 6-18; 92; 93: 1-7)

*Form:* These pots had a short, relatively upright rim that was broadened and undercut in the lower part (Pls. 91: 6-18; 92; 93: 1-7). The rim edge was positioned vertically or was obliquely inclined towards the inside or outside. The rim's interior was straight, and had no groove upon which the lid could rest. The neck transforms into a steep shoulder.

Two variants were established:

4a: The rim was distinctively broadened and undercut (Pl. 91: 6-18).

4b: The rim was only slightly broadened and undercut (Pls. 92; 93: 1-7). In this case the rim shape could come close to type 2, but the rim in type 4 was shorter and more upright.

*Size:* Small pots prevailed, some were medium and none were truly large.

*Manufacture:* No special characteristics were established.

<sup>48</sup> Na Invillinu in Sv. Hemi so v ta tip uvrščeni tudi lonci s spodrezanim ustjem, ki jih tu obravnavam ločeno.

<sup>48</sup> At Invillino and Hemmaberg this type also included pots with an undercut rim, which are treated separately in this text.

TIP / TYPE 1

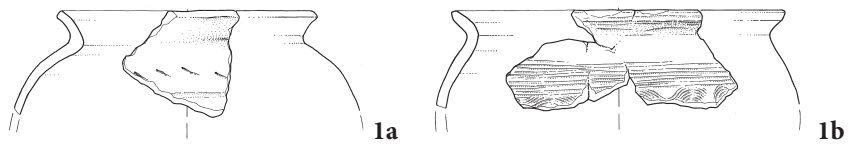

TIP / TYPE 2

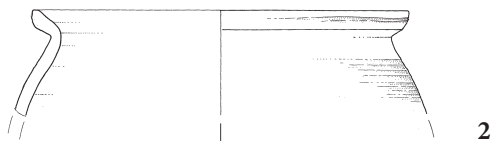

TIP / TYPE 3

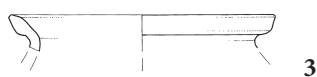

TIP / TYPE 4

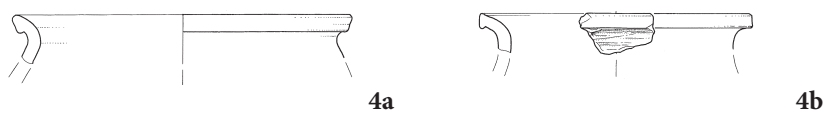

TIP / TYPE 5

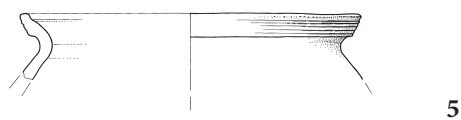

TIP / TYPE 6

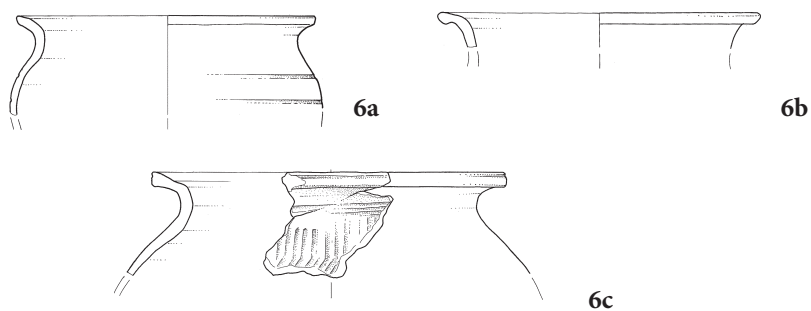

TIP / TYPE 7

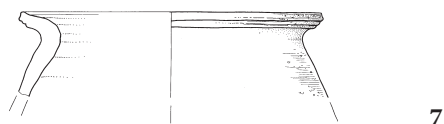

TIP / TYPE 8

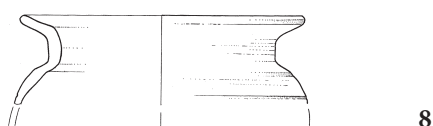

Tab. 4.2: Tipi loncev s Tonovcovega gradu. M. = 1:4.

Tab. 4.2: Pot types from Tonovcov grad. Scale = 1:4.

13,15) z razširjenim robom ustrezajo tipu Invillino III k (Bierbrauer 1987, t. 78: 7).

Varianta 4b ustreza tipu Invillino III d4 (Bierbrauer 1987, 198, t. 76: 1–5). Najdeni so bili tudi na Rodiku (Ciglencečki 2000, sl. 115: 5–6,11), Korinjskem hribu (Ciglencečki 1985, t. 6: 68), Kučarju (J. Dular, Ciglencečki, A. Dular 1995, t. 6: 14; 82: 8), Svetih gorah (P. in J. Korošec 1978, t. 3: 3; 4: 1), Križni gori (Ciglencečki 2000, sl. 105: 8–10), Sv. Pavlu (Svoljšak 1985, t. 1: 16; 3: 51; 6: 95–96), Gradišču nad Bašljem (Ciglencečki 2000, sl. 121: 10,12–15,19), Ajdnu (Ciglencečki 2000, sl. 123: 13–15), v Vidulisu (Rupel 1988, št. 1) in Coseanu (Rupel 1988, 158, št. 40). Na Sv. Hemi se pojavljajo redko (Ladstätter 2000, 137–138, t. 41: 3). Dokaj izjemne oblike je lonec (morda vrček) katerega kratko ustje prehaja neposredno v dolgo in položno rame in tako spominja na oblike langobardskih lončkov (t. 93: 7). Podoben lonček je poznan s Sv. Heme, kjer je ravno tako okrašen z več enojnimi valovnicami in opredeljen kot langobardsko vplivan (Ladstätter 2000, 142–143, sl. 63: 5). Na Tonovcovem gradu je bil najden v SE 24, ki pomeni hodno površino na zunanji strani stavbe 1 in je vsebovala najdbe iz prve in druge poznoantične faze.

Obe varianti se pojavljata tudi v zgodnesrednjeveških kontekstih na furlanskih, primorskih in osrednje-slovenskih najdiščih. V Furlaniji so bili najdeni v Osopu (Lusuardi Siena, Negri, Villa 2004, sl. 8: 2; 11: 11–12,16), San Daniele del Friuli (Lusuardi Siena, Negri, Villa 2004, sl. 8: 11; 11: 13–15; 14: 6) in Concordiji (Lusuardi Siena, Negri, Villa 2004, sl. 8: 6), na Primorskem v Kopru (Cunja 1996, t. 34: 369–371; 35: 372,373), na Gorenjskem na blejski Pristavi (Belak, Pleterski, Knific 2008; t. 5: 4; 7: 16; 8: 17–18; 9: 10: 1–10; 11; 12: 3), v osrednji Sloveniji pa v Dragomlju (Turk 2002, št. 3,7,15) in na Gorenjem Mokronogu (Pleterski, Belak 2002, št. 9).

*Datacija:* Glede na primer z Rodika lahko njihov začetek postavimo vsaj v sredino 5. st. na Invillinu so značilni za periodo III (Bierbrauer 1987, 208), to je za drugo polovico 5. in za 6. st. Tudi na Tonovcovem gradu njihov stratigrafski položaj kaže na največjo priljubljenost v 6. st. So pa lonci tega tipa očitno dolgo v uporabi, kar kaže pojava te oblike v zgodnesrednjeveških kontekstih v Furlaniji (Lusuardi Siena, Negri, Villa 2004, sl. 8: 1–2,6–12; 11: 7–16; 14: 6,10–11), obmorskih mestih (Cunja 1996, t. 34: 369–371; 35: 372–373) in v osrednji Sloveniji (Turk 2002; Pleterski, Belak 2002). Te pozne oblike imajo navadno bolj izrazito oblikovan, včasih fasetiran zaključek ustja, ki ustreza tipu Invillino III k (Lusuardi Siena, Negri, Villa 2004, sl. 8: 6–7,11–12; 9: 1,7–8; 11: 7–9).

**Tip 5** (t. 93: 8–11; 94; 95: 1–7; 102: 11–12; 106: 1–2)

*Oblika:* Gre za lonce s kratkim izvihanim, na zunanji strani odebeljenim ustjem, ki je na spodnji strani izrazito spodrezano, na notranji pa usločeno tako, da

*Decoration:* Due to the poor condition of the remains it is hard to assume the decoration. Some type 4a pots had grooved rims (Pl. 91: 14,18). In some cases the walls right under the rim were also decorated with deep grooves (Pl. 91: 15,18), and sometimes grooves appeared on the inner side of the vessel. Amongst type 4b pots the small pot Pl. 93: 7 stood out, for it was decorated with three single wave lines separated by a groove. In one example the wave line decoration appeared also on the inner side of the rim (Pl. 93: 1).

*Position:* At Tonovcov grad their placement in Late Antiquity 1 layers is not entirely reliable (SU 24, where they were common, included mixed material from LA 1 and LA 2 phases), however they dominated in Late Antiquity 2, i.e. in the 6<sup>th</sup> century. They were rare in Early Medieval layers (Fig. 4.12).

*Analogies:* This type has many analogies at Invillino. Type 4a mainly corresponds to type III d2 (with the vertically positioned rim edge, Bierbrauer 1987, Pl. 75: 6–15), some examples correspond to type III d3 (with the distinctively obliquely positioned rim edge, Bierbrauer 1987, Pl. 76: 1–2) or type III e (with the distinctively upright neck, Bierbrauer 1987, Pl. 74: 12–17). Pots belonging to this type were also discovered in Piran (Vidrih Perko 1994a, Fig. 5: 8), Sv. Pavel (Svoljšak 1985, Pls. 1: 15; 3: 50) and Aquileia (Rupel 1994, Pl. 3: CCg 42–44). Some forms (Pl. 31: 13,15) with a broadened edge correspond to Invillino type III k (Bierbrauer 1987, Pl. 78: 7).

Type 4b corresponds to Invillino type III d4 (Bierbrauer 1987, 198, Pl. 76: 1–5). Similar pots were also found on Rodik (Ciglencečki 2000, Fig. 115: 5–6,11), Korinjski hrib (Ciglencečki 1985, Pl. 6: 68), Kučar (J. Dular, Ciglencečki, A. Dular 1995, Pls. 6: 14; 82: 8), Svete gore (P. and J. Korošec 1978, Pls. 3: 3; 4: 1), Križna gora (Ciglencečki 2000, Fig. 105: 8–10), Sv. Pavel (Svoljšak 1985, Pls. 1: 16; 3: 51; 6: 95–96), Gradišče nad Bašljem (Ciglencečki 2000, Fig. 121: 10,12–15,19), Ajdna (Ciglencečki 2000, Fig. 123: 13–15), in Vidulis (Rupel 1988, No. 1) and Coseano (Rupel 1988, 158, No. 40). At Hemmaberg they were rare (Ladstätter 2000, 137–138, Pl. 41: 3). The pot (or possibly jug) with the short rim that ran directly into the long and gradually sloping shoulder represents a relatively unique shape that is reminiscent of Lombard small pots (Pl. 93: 7). A similar small pot was found at Hemmaberg, where it was decorated with multiple wave lines and was thought to have been influenced by Lombard pottery (Ladstätter 2000, 142–143, Fig. 63: 5). At Tonovcov grad it was found in SU 24, which was the floor level on the outer side of building 1 that included finds from Late Antiquity phases 1 and 2.

Both variants also appear in Early Medieval contexts in Friuli, on the Slovenian coast and in central Slovenia. In Friuli they were found in Osoppo (Lusuardi Siena, Negri, Villa 2004, Figs. 8: 2; 11: 11–12,16), San Daniele del Friuli (Lusuardi Siena, Negri, Villa 2004, Figs. 8: 11; 11: 13–15; 14: 6) and Concordia (Lusuardi Siena, Negri, Villa 2004, Fig. 8: 6), on the Slovenian coast in Koper (Cunja

tvori utor za pokrov. Utor je lahko zelo izrazit (*t. 93: 8–10; 94*), lahko pa je notranja stran le rahlo usločena (*t. 95: 1–5*). Vrat je pri ohranjenih primerih kratek, prehod v rame oster. Oblika je na Tonovcovem gradu dokaj številna.

*Velikost:* Prevladujejo srednje veliki lonci

*Izdelava:* Opaziti ni nobenih zakonitosti.

*Okras:* Tudi pri loncih tipa 5 je zaradi slabe ohranjenosti težko sklepati o okrasu. Na zunanjem robu ustja se pogosto pojavlja žlebljenje, medtem ko je na ostenju očitno prevladovalo metličenje. V enem primeru (*t. 93: 8*) je ostenje okrašeno z nizi kratkih poševnih vrezov. Na Invillinu pri loncih tega tipa prevladuje metličenje in žlebljenje, pojavlja pa se tudi kombinacija valovnice z metličanjem (Bierbrauer 1987, *t. 77: 1*).

*Lega:* Nekaj primerov je bilo najdenih že v plasteh prve poznoantične faze (*t. 94: 13; 95: 2,5*), prevladujejo pa v plasteh druge poznoantične faze. En primer (*t. 93: 9*) je bil najden v zgodnesrednjeveški plasti.

*Analogije:* Podobni lonci so pogosti na Invillinu, kjer so uvrščeni v tipa III f1 (le rahlo usločen notranji rob) in III f2 (izrazito usločen notranji rob; Bierbrauer 1987, *t. 76: 9–10; 77: 1–6; 119: 15; 120: 12*), nekateri primeri s Tonovcovega gradu (npr. *t. 93: 10; 94: 3; 95: 2*) se približujejo tudi tipu III f4 s skoraj vertikalno zaključenim robom ustja (Bierbrauer 1987, *t. 98: 11–12; 102: 6–7*). Na furlanskem prostoru je za ta tip mogoče najti analogije tudi v zgodnesrednjeveških kontekstih, tako npr. v Attimisu – San Giorgio (Villa 2003, *t. 2: 6*) in v Concordiji (Lusuardi Siena, Negri, Villa 2004, *sl. 8: 3,5*).

Lonci tipa 5 so znani tudi s Sv. Heme (Ladstätter 2000, *t. 11: 8*). Na vzhodneje ležečih najdiščih se zdi, da so oblikovani nekoliko drugače, z bolj ostrim klekom na notranji strani ustja, ob prehodu v rame, ki je na tonovskih primerih bolj tekoč. To velja npr. za primere z Gradca pri Prapretnem (Ciglencečki 1981, *t. 1: 3–5; 4: 45*) in Tinja (Ciglencečki 2000, *t. 20: 4,8,11–13; 21: 2–14*).

*Datacija:* Na Invillinu so taki lonci postavljeni v periodo III, ki sodi v drugo polovico 5. in v 6. st. (Bierbrauer 1987, 208–209). Ciglencečki na Tinju poudarja njihovo poznoantično tradicijo z možnimi prežitki v slovansko obdobje (Ciglencečki 2000, 66). Uporabo loncev tega tipa v zgodnesrednjeveškem obdobju potrjujejo tudi primeri iz Furlanije, kjer so datirani v čas od 7. do 9. st. (Lusuardi Siena, Negri, Villa 2004, 84–87). Na Tonovcovem gradu njihova stratigrafska lega kaže na začetek uporabe sicer že v 5. st., najbolj priljubljeni pa so bili v 6. st.

**Tip 6** (*t. 95: 8–11; 96; 102: 14–15; 104: 1–8; 106: 12*)

*Oblika:* Dokaj številno skupino na Tonovcovem gradu sestavljajo lonci z dolgim, včasih skoraj horizontalno izvihanim ustjem, izrazitim, usločenim dolgim

1996, *Pls. 34: 369–370,371; 35: 372–373*), in Gorenjska at Pristava in Bled (Belak, Pleterski, Knific 2008; *Pls. 5: 4; 7: 16; 8: 17–18; 9; 10: 1–10; 11; 12: 3*) and in central Slovenia in Dragomelj (Turk 2002, Nos. 3,7,15) and Gorenji Mokronog (Pleterski, Belak 2002, Pl. No 9).

*Date:* Taking into account the example from Rodik we can place the beginning of this type into the mid 5<sup>th</sup> century. At Invillino they were characteristic for the period III (Bierbrauer 1987, 208–209), i.e. second half of the 5<sup>th</sup> and the 6<sup>th</sup> century. Their stratigraphic position on Tonovcov grad indicated that they were most popular in the 6<sup>th</sup> century. Pots of this type were obviously in use for a long time, which is indicated by the appearance of this form in the Early Medieval contexts in Friuli (Lusuardi Siena, Negri, Villa 2004, *Figs. 8: 1–2,6–12; 11: 7–16; 14: 6,10–11*), coastal towns (Cunja 1996, *Pls. 34: 369–371; 35: 372–373*) and central Slovenia (Turk 2002; Pleterski, Belak 2002). The later forms usually have a more distinctively formed, sometimes grooved rim ending, which corresponds to type Invillino III k (Lusuardi Siena, Negri, Villa 2004, *Figs. 8: 6–7,11–12; 9: 1,7–8; 11: 7–9*).

**Type 5** (*Pls. 93: 8–11; 94; 95: 1–7; 102: 11–12; 106: 1–2*)

*Form:* These were pots with a short everted rim, thickened on the outer side, distinctively undercut on the lower side and concave on the inner side so that it formed a groove for the lid. In some examples the groove was explicitly pronounced (*Pls. 93: 8–10; 94*), or merely slightly concave on the inner side (*Pl. 95: 1–5*). In the preserved examples the neck was short, and it had a sharp transition into the shoulder. This shape was relatively common on Tonovcov grad.

*Size:* Medium sized pots prevailed.

*Manufacture:* No special characteristics could be noticed.

*Decoration:* The poor condition of type 5 pots made it hard to define the decoration. Grooves often appeared on the rim's outer side, while brush strokes seemed to prevail on the body walls. In one example (*Pl. 93: 8*) the body walls were covered by a series of short oblique incisions. On Invillino brush strokes and grooves prevailed in this type, however a combination of wavy lines and brush strokes was also found (Bierbrauer 1987, *Pl. 77: 1*).

*Position:* A few examples were found already in Late Antiquity 1 layers (*Pls. 94: 13; 95: 2,5*), however they were most common in Late Antiquity 2 layers. One example (*Pl. 93: 9*) was discovered in an Early Medieval layer.

*Analogies:* Similar pots were common at Invillino where they were placed into types III f1 (slightly concave inner edge) and III f2 (distinctively concave inner edge; Bierbrauer 1987, *Pls. 76: 9–10; 77: 1–6; 119: 15; 120: 12*). Some examples from Tonovcov grad (e.g. *Pls. 93: 10; 94: 3; 95: 2*) came close to type III f4 with the almost vertically ended rim edge (Bierbrauer 1987, *Pls. 98: 11–12; 102:*

vratom in trebušastim spodnjim delom. Od tipa 1 se razlikujejo po dolgem vratu, čeprav je ločitev med njimi včasih težka.

Ločimo tri variante ustja:

6a: Preprosto vodoravno ali poševno izvihano, neodebeljeno ustje (*t.* 95: 8–11; 96: 1–4; 102: 14–15; 104: 1–5,7);

6b: vodoravno ali poševno izvihano ustje z odebeljenim robom (*t.* 96: 5–6; 102: 15; 106: 12);

6c: vodoravno izvihano, na notranji strani usločeno ustje (*t.* 96: 7–9,11–15; 104: 6,8).

Rob ustja je v večini primerov polkrožno zaključen, le redko (*t.* 96: 7,13,15) je raven. Opazno pri loncih vseh variant je, da je ostenje relativno tanko glede na njihovo velikost.

*Velikost:* Prevladujejo srednje veliki lonci s premerom med 15 in 18 cm, precej je velikih loncev s premerom med 18 in 23 cm, nekaj pa majhnih, s premerom med 10 in 14 cm.

*Izdelava:* Izrazito prevladujejo lonci, ki sodijo v TS 5, TS 9 in TS 10. Gre za sorodne tehnološke skupine, poleg teh je z nekaj primeri zastopana TS 8, z enim TS 4 in z enim TS 13.

*Lega:* Velika večina loncev tipa 6 je bila najdena v zgodnjerednjevških plasteh in sicer tako na območju stavbe 1 kot tudi cerkvenega sklopa in cisterne. Večina jih je bila najdena v več odlomkih, kar na Tonovcovem gradu za zgodnejše faze ni običajno.

*Okras:* Večina loncev tipa 6 je neokrašenih, v enem primeru se pojavlja z nizi navpičnih žlebov okrašeno ostenje (*t.* 96: 7). Z enojno valovnico je okrašen lonec iz stavbe 2 (*t.* 102: 14). Lonec, najden v osrednji cerkvi, je okrašen s tremi linijami enojne, precej nepravilno izvedene valovnice, ločene z vodoravnimi kanelurami (*t.* 104: 3).

*Analogije:* Gre za dokaj pogosto obliko, ki se pojavlja tako v poznoantičnih kot zgodnjerednjevških kontekstih. Na furlanskem prostoru so poznani z Invillina (Bierbrauer 1987, t. 73: 1–4; 84: 1; 85: 1–3,11; 86: 7; 89: 9–10,12; 92: 16; 99: 1; 112: 1; 116: 8; 118: 9), Vidma (Buora, Fasano 1994, t. 2: III a1, III a2, III a3, III d1) in Attimisa – San Giorgio (Villa 2003, t. 2: 1–2,4). Najdeni so bili tudi na grobiščih v Špetru (San Pietro al Natisonne), kjer so datirani v drugo polovico 6. in začetek 7. st. (Borzaconi 2007, t. 4: 1) ter v Romans d'Isonzo (Maselli Scotti 1989, t. 2: 10,18–19).

Podobni lonci so bili najdeni tudi v Kopru (Cunja 1996, t. 34: 363–367) in na Gorenjskem na blejski Pristavi (Belak, Pleterski, Knific 2008; t. 10: 13; 12: 1). V osrednji in vzhodni Sloveniji so poznani s Tinja, kjer so uvrščeni v tip 4 (Ciglencečki 2000, 65; t. 17; 18), Vranja (Knific 1979, št. 51,78, 80,85), Gorenjega Mokronoga (Pleterski, Belak 2002, št. 10–11) in Dragomlja (Turk 2002, št. 1, 2; sl. 4, 5). Na Koroškem so poznani s Sv. Heme (Ladstätter 2000, t. 50: 8) in Teurnije (Rodriguez 1997, t. 2: 10,12).

6-7). In Friuli the analogies for this type were also found in Early Medieval contexts, e.g. in Attimis – San Giorgio (Villa 2003, Pl. 2: 6) and in Concordia (Lusuardi Siena, Negri, Villa 2004, Fig. 8: 3,5).

Type 5 pots were also found at Hemmaberg (Ladstätter 2000, Pl. 11: 8). Towards the east it seems that the pots were formed slightly differently, sharper carinated (compared to the examples from Tonovcov grad) on the inner side of the rim, at the transition into the shoulder. This was also found to be true in the examples from Gradec near Prapretno (Ciglencečki 1981, Pls. 1: 3-5; 4: 45) and Tinje (Ciglencečki 2000, Pls. 20: 4,8,11-13; 21: 2-14).

*Date:* At Invillino such pots were dated into period III, i.e. the second half of the 5<sup>th</sup> and the 6<sup>th</sup> century (Bierbrauer 1987, 208-209). Ciglencečki stressed that at Tinje they were a part of the Late Antique tradition with possible residues into the Slav period (Ciglencečki 2000, 66). The use of this type in the Early Medieval period was also confirmed by the examples from Friuli, where they were dated to sometime between the 7<sup>th</sup> and 9<sup>th</sup> century (Lusuardi Siena, Negri, Villa 2004, 84-87). On Tonovcov grad their stratigraphic position indicated that they were used already in the 5<sup>th</sup> century, however they reached the peak of their popularity in the 6<sup>th</sup> century.

**Type 6** (*Pls.* 95: 8-11; 96: 102: 14-15; 104: 1-8; 106: 12)

*Form:* The relatively numerous group at Tonovcov grad is composed of pots with a long, sometimes almost horizontally everted rim, a pronounced, concave long neck and a spherical body. They differ from type 1 by their long necks, even though the division between the two can sometimes be difficult.

Three rim variants were established:

6a: Simple horizontal or obliquely everted, non-thickened rim (*Pls.* 95: 8-11; 96: 1-4; 102: 14-15; 104: 1-5,7);

6b: horizontal or obliquely everted rim with a thickened edge (*Pls.* 96: 5-6; 102: 15; 106: 12);

6c: horizontally everted rim, concave on the inner side (*Pl.* 96: 7-9,11-15; 104: 6,8).

In most cases the rim edge was semi-circularly ended, only rarely (*Pl.* 96: 7,13,15) was it straight. Considering their size all subtypes have relatively thin walls.

*Size:* Medium sized pots with a diameter ranging from 15 to 18 cm prevail, the large pots with a diameter between 18 and 23 cm were also common and some small pots with the diameter between 10 and 14 cm were represented.

*Manufacture:* Pots made in the similar technological groups (TG 5, TG 9 and TG 10) were by far the most common. Some pots were made in TG 8, one example in TG 4 and one in TG 13.

*Position:* Most type 6 pots were discovered in Early Medieval layers, in the excavation area of building 1, ec-



*Datacija:* Najbližje analogije so v Furlaniji. Na najdišču San Giorgio v Attimisu so bili lonci tega tipa najdeni v plasteh, ki pripadajo času po opustitvi objektov (Villa 2003, 302–305). Na Kapucinskem vrtu v Koperu so na podlagi odsotnosti uvožene keramike v kontekstih s takimi lonci le-ti postavljeni v čas po koncu 6. st. (Cunja 1996, 124–126). Na Tinju so bili najdeni večinoma v kontekstih, ki sodijo v zgodnjerednjeveško obdobje (Ciglencečki 2000, 65, 140, sl. 146). Na Gorenjem Mokronogu so interpretirani kot staroselski prežitek v slovanskodobnem okolju oziroma kot primer, kjer je prihajalo do prenosa lončarskih znanj med staroselci in Slovani (Pleterski, Belak 2002, 102; sl. 8). Tudi podobni lonci iz Dragomlja so datirani v čas po koncu 7. st. (Turk 2002, 82–83).<sup>49</sup>

Tudi lonci s Tonovcovega gradu so bili večinoma najdeni v zgodnjerednjeveških plasteh. Predstavljajo najmlajše keramično gradivo na Tonovcovem gradu in tvorijo dokaj enotno skupino. Poleg oblike jih družijo enotna izdelava in skoraj popolna odsotnost okrasa.

#### Tip 7 (t. 97: 1–6; 102: 16)

*Oblika:* V ta tip so uvrščeni lonci z dolgim, skoraj vodoravno izvihanim, lahko rahlo odebeljenim ustjem, ki skoraj brez vratu prehaja v vrečast trup. Ustje je na notranji strani rahlo usločeno. Rob ustja je lahko žlebljen (t. 97: 1–2) ali rahlo razširjen (t. 97: 5).

*Velikost:* Prevladujejo srednje veliki lonci.

*Okras:* Kot je mogoče sklepati iz ohranjenih ostenj, so bili lonci tega tipa večinoma neokrašeni.

*Izdelava:* Prevladujejo lonci dokaj trde, kvalitetne fature.

*Lega:* Večina jih je bilo najdenih v plasteh druge poznoantične faze (sl. 4.12).

*Analogije:* Na Invillinu je oblika redko zastopana, blizu so ji nekatere variante tipa III f1 (Bierbrauer 1987, t. 77: 5–6,13), pa tudi tipa III l (Bierbrauer 2000, t. 78: 9,11). Podobne oblike so poznane tudi iz Akvileje (Rupel 1994, CCg 16–20). Pojavljajo se tudi na najdiščih vzhodne in osrednje Slovenije. Na Tinju jim ustrezajo nekateri lonci tipa 5 (Ciglencečki 2000, t. 21; 22), vendar so tinjski primeri oblikovani nekoliko bolj ostro kot naši. Podobno velja za primere z Vranja (Knific 1979, 101; Mirnik-Prezelj 1984, t. 12: 146; 13: 150; 15: 158–160), Vipote (Ciglencečki 2000, sl. 90: 2) in Betnave (Strmčnik 1997, t. 1: 8). Na Sv. Hemi ustreza varianti 2 tipa 6 (Ladstätter 2000, t. 13: 1).

*Datacija:* Na Tinju se pojavljajo izključno v poznoantičnih kompleksih, njihova odsotnost pa naj bi (posebej v južnonoriškem prostoru) pomenila odsotnost poselitve v drugi polovici 5. in v 6. st. (Ciglencečki 2000,

clesiastical complex and the cistern. Most of them were found in numerous pieces, which is unusual for the early phases at Tonovcov grad.

*Decoration:* Most type 6 pots were not decorated, in one example the walls were decorated with a series of vertical grooves (Pl. 96: 7). The pot from building 2 (Pl. 102: 14) was decorated with a single wavy line. The pot found in the central church was decorated with three relatively uneven wavy lines, separated by horizontal grooves (Pl. 104: 3).

*Analogies:* This was a relatively common shape that appeared in Late Antique as well as Early Medieval contexts. In Friuli they were found at Invillino (Bierbrauer 1987, Pls. 73: 1-4; 84: 1; 85: 1-3,11; 86: 7; 89: 9-10,12; 92: 16; 99: 1; 112: 1; 116: 8; 118: 9), Udine (Buora, Fasano 1994, Pl. 2: III a1, III a2, III a3, III d1) and Attimis – San Giorgio (Villa 2003, Pl. 2: 1-2,4). They were also found in cemeteries in San Pietro al Natisone, where they were dated into the second half of the 6<sup>th</sup> and the beginning of the 7<sup>th</sup> century (Borzaconi 2007, Pl. 4: 1), and at Romans d'Isonzo (Maselli Scotti 1989, Pl. 2: 10,18-19).

Similar pots were also found in Koper (Cunja 1996, Pl. 34: 363-367) and at Pristava in Bled (Belak, Pleterski, Knific 2008; Pls: 10: 13; 12: 1). They are known at Tinje (type 4, Ciglencečki 2000, 65; Pls. 17; 18), Vranje (Knific 1979, Nos. 51,78,80,85) Gorenji Mokronog (Pleterski, Belak 2002, Nos. 10-11), Dragomelj (Turk 2002, Nos. 1-2; Figs. 4-5). In Carinthia they were discovered at Hemmaberg (Ladstätter 2000, Pl. 50: 8) and Teurnia (Rodriguez 1997, Pl. 2: 10,12).

*Date:* The closest analogies were found in Friuli. In San Giorgio in Attimis this type was found in layers that belong to the period after the buildings were abandoned (Villa 2003, 302-305). In Kapucinski vrt in Koper these pots were dated sometime after the 6<sup>th</sup> century due to the lack of imported pottery in the contexts with such pots (Cunja 1996, 124-126). At Tinje they were mainly found in Early Medieval contexts (Ciglencečki 2000, 65, 140, Fig. 146). In Gorenji Mokronog they were interpreted as an autochthonous Romanised settlers' remnant within the Slav environment or as an example of how pottery skills passed from the original settlers to the Slavs (Pleterski, Belak 2002, 102; Fig. 8). Similar pots from Dragomelj were dated sometime after the 7<sup>th</sup> century (Turk 2002, 82-83).<sup>49</sup>

On Tonovcov grad most of the pots belonging to this type were found in Early Medieval layers. They represent the youngest pottery group at Tonovcov grad and form a relatively unified group. Apart from the shape they also shared the unified manufacture and the almost total lack of decoration.

<sup>49</sup> V Dragomlju je bil lonec podobne oblike izdelan na hitrem vretenu, najden pa v jami, z radiokarbonsko datacijo postavljeni v 8. st. (Turk 2002, 83).

<sup>49</sup> In Dragomelj a similarly shaped pot made on a fast spinning potter's wheel was found in a pit which is placed into the 8<sup>th</sup> century on the base of radiocarbon dating (Turk 2002, 83).

139). Na Sv. Hemi se pojavljajo izključno v plasteh 5. st. (Ladstätter 2000, 139). Na Tonovcovem gradu pa jih glede na njihovo stratigrafsko lego lahko postavimo v 6. st.

#### Tip 8 (t. 97: 7; 106: 3–5)

*Oblika:* Gre za majhno skupino loncev z izvihanim ustjem in izrazitim, cilindrično oblikovanim vratom. Prehod ustja v vrat je oster. Cilindrična oblika vratu in oster prehod vratu v ustje in ostenje jih loči od loncev tipa 6, pri katerih je prehod bolj tekoč.

*Okras:* Kot je mogoče sklepati iz ohranjenih ostenj, so bili lonci tega tipa večinoma neokrašeni, včasih se na ostenju pojavljajo kanelure ali vodoravno metličenje.

*Izdelava:* Opaziti ni nobenih zakonitosti.

*Lega:* Vsi so bili najdeni v plasteh prve poznoantične faze.

*Analogije:* Tip na obravnavanem prostoru ni pogost. Podobne oblike so poznane s Hrušice (Giesler 1981, t. 48: 4–5).

#### VRČI

Med vrče uvrščamo posode z izvihanim ustjem, izrazitim vratom, kroglastim trupom in enim ali več ročajev. Na Tonovcovem gradu so zastopani redko (t. 97: 8–16).

Ohranjeno je ostenje enoročajnega vrčka z strmimi ramami, okrašenega z valovnico med dvema horizontalnima žlebovoma (t. 97: 8). Ustje ni ohranjeno, možno je, da se je razširilo v izlivke, kot je to primer pri podobnem vrčku z Ajdne (Ciglencečki 2000, sl. 124: 8) ali Šenturške gore (Rodriguez 1997, t. 7: 72). Vrček izvira iz premešanih plasti.

Pri drugem primeru (t. 97: 9) gre za ostenje kroglastega (verjetno dvoročajnega) vrčka, pri katerem ustje ravno tako ni bilo ohranjeno.

Poleg tega je bilo najdenih še nekaj ročajev, ki so ravno tako pripadali vrčkom (t. 97: 10–16).

Posebne zakonitosti pri pojavljanju vrčkov ni opaziti, saj so bili najdeni v plasteh prve in druge poznoantične faze. Večinoma so izdelani kvalitetno, prevladuje oksidacijsko žganje in trda, včasih glajena površina (TS 8 in 13).

Skromno število vrčkov je bilo najdeno tudi na Invillinu, kjer je postavljena domneva, da so se kot namizno pivsko posodje uporabljali v glavnem stekleni kozarci, ki so bili najdeni v velikem številu (Bierbrauer 1987, 194). Podobno lahko domnevamo tudi za Tonovcov grad, kjer je bilo ravno tako najdeno veliko steklenih kozarcev (glej pogl. 3.1)

#### Type 7 (Pls. 97: 1-6; 102: 16)

*Form:* This type consists of pots with long, almost horizontally everted, slightly thickened rims that transform into a bag shaped body almost without a neck. On the inner side the rim was slightly concave. The edge of the rim could be grooved (Pl. 97: 1-2) or slightly widened (Pl. 97: 5).

*Size:* Medium sized pots prevail.

*Decoration:* The preserved walls indicate that most pots belonging to this type were not decorated.

*Manufacture:* Pots of a relatively hard, quality fabric dominate.

*Position:* Most of them were found in Late Antiquity 2 layers (Fig. 4.12).

*Analogies:* This shape was rare at Invillino, however it sometimes corresponds to some III f1 (Bierbrauer 1987, Pl. 77: 5-6,13) and III l subtypes (Bierbrauer 2000, Pl. 78: 9,11). Similar forms were also found in Aquileia (Rupel 1994, CCg 16-20). They also appear in east and central Slovenia. This type corresponds to some type 5 pots in Tinje (Ciglencečki 2000, Pls. 21; 22), however the Tinje examples have a slightly sharper design. Similar can be said for the examples from Vranje (Knific 1979, No. 101; Mirnik-Prezelj 1984, Pls. 12: 146; 13: 150; 15: 158-160), Vipota (Ciglencečki 2000, Fig. 90: 2) and Betnava (Strmčnik 1997, Pl. 1: 8). At Hemmaberg it corresponds to type 6 variant 2 (Ladstätter 2000, Pl. 13: 1).

*Date:* At Tinje they appear exclusively in Late Antique contexts, and their absence is supposed to (especially in the south Noricum area) indicate that it was not inhabited during the second half of the 5<sup>th</sup> and in the 6<sup>th</sup> century (Ciglencečki 2000, 139). At Hemmaberg they appeared exclusively in 5<sup>th</sup> century layers (Ladstätter 2000, 139), while at Tonovcov grad their stratigraphic position placed them into the 6<sup>th</sup> century.

#### Type 8 (Pls. 97: 7; 106: 3-5)

*Form:* This is a small group of pots with an everted rim and a pronounced, cylindrically shaped neck. The transition from the rim into the neck is sharp. The cylindrical neck shape and the sharp transition of the neck into the rim and body make them different from the type 6 pots with a smoother transition.

*Decoration:* The preserved walls indicate that most pots belonging to this type were not decorated, however sometimes grooves or horizontal brush strokes could be seen on the walls.

*Manufacture:* No special characteristics have been noticed.

*Position:* All were found in Late Antiquity 1 layers.

*Analogies:* This type was not common in the discussed area. Similar forms were found at Hrušica (Giesler 1981, Pl. 48: 4-5).

## 4.2.3 OKRAS

Na keramiki s Tonovcovega gradu se pojavljajo tri osnovne krasilne tehnike: tehnika vrezovanja, vtiskovanja in modeliranja.

Okrasi v teh tehnikah so lahko izvedeni z različnimi instrumenti. Tako imamo pri vrezovanju zastopan pravi vrez (izveden z ostrim orodjem tako, da je profil v obliki črke V), žleb ali kaneluro (profil v obliki črke U) in glavničenje oziroma metličenje. Meja med njima ni vedno jasna, v osnovi pa velja, da so zareze, narejene z glavničastim orodjem (nem. *Kammstrich*, it. *pettine*) bolj ostre in pravilne od tistih, narejenih z metlico (nem. *Besenstrich*, it. *scopetto*). Ta delitev je posebno težka (včasih nemogoča) pri nepravilno izvedenem okrasu na ročno izdelanih posodah (Ladstätter 2000, 150). Vse oblike vrezovanja so bile na keramiko s Tonovcovega gradu izvedene pred žganjem, kar je splošna značilnost poznoantične keramike vzhodnoalpskega prostora (Martelli 1995, 121; Ladstätter 2000, 151).

Vtiskovanje je navadno izvedeno z ostrim predmetom v površino posode pred žganjem. Tudi pri tej tehniki so orodja lahko različna, na keramiki s Tonovcovega gradu prevladujejo vtisi s kratkim, ostrim predmetom (noht, šilo). Poznamo tudi vtise z glavničastim predmetom.

Pri modeliranju gre za oblikovanje plastičnih izboklin iz stene posode. Pri obravnavani keramiki so to večinoma rebra, ki so ponavadi okrašena še s tehniko vtiskovanja, lahko pa so iz stene posode modelirani tudi ročaji.

## METLIČENJE OZIROMA GLAVNIČENJE

Najpogostejša krasilna tehnika na Tonovcovem gradu je glavničenje oziroma metličenje, ki se pogosto družijo tudi z drugimi vrstami okrasa. Pojavlja se lahko na zunanji, notranji ali obeh straneh posode. Bolj pogosto je uporabljeno na skledah, pojavlja pa se tudi na loncih. Linije lahko potekajo vodoravno, poševno ali v več smeri, ko nastane motiv mreže.

Metličenje in glavničenje sta na rimski keramiki pogost motiv, njegova tradicija pa na obravnavanem območju sega še v predrimski čas. V poznorimskem obdobju postane prevladujoč dekorativni element grobe keramike,<sup>50</sup> njegova priljubljenost se nadaljuje skozi vse obdobje pozne antike tudi v zgodnji srednji vek. H. Rodriguez je predpostavila razvoj glavničenja v pozni antiki od finega h grobemu (Rodriguez 1988, 144; 1992, 168–169; 1997, 153–154). Pri tem naj bi bilo fino metličenje v ozki povezavi z ornamentom

<sup>50</sup> Priljubljenost metličenja v 4. st. kaže primer Hrušice, kjer se pojavlja horizontalno, navpično in poševno metličenje, pa tudi metličenje v več smereh (Giesler 1981, t. 46: 9–16, 18–30; 47: 2–8, 14–15, 20, 22, 24; 48: 4–9, 18–23, 28, 31).

## JUGS

Jugs are vessels with an everted rim, pronounced neck, rounded body and one or more handles. They were rare on Tonovcov grad (*Pl. 97: 8–16*).

The wall of a single-handle jug with steep shoulders, decorated with a wavy line between two horizontal grooves was found (*Pl. 97: 8*). The rim was not preserved, however it could have widened into a spout, as was the case with the similar jugs from Ajdna (Ciglencečki 2000, Fig. 124: 8) or Ulrichsberg (Rodriguez 1997, Pl. 7: 72). The jug was found in mixed layers.

The second discovered example (*Pl. 97: 9*) consisted of the walls of a rounded (most likely double-handled) jug. The rim was also not preserved.

A few jug handles were also discovered (*Pl. 97: 10–16*).

No special characteristics were noticed as regards the location of the jugs, for they were found in Late Antiquity 1 and 2 layers. Most of them were of quality manufacture, oxidation fired with a hard, sometimes smoothed surface (TG 8 and 13).

Several jugs were found at Invillino, where it was assumed that glass goblets were used as drinking vessels, for they were found in large numbers (Bierbrauer 1987, 194). Similar can also be assumed for Tonovcov grad, where large numbers of glass goblets were discovered (see chapter 3.1)

## 4.2.3 DECORATION

Pottery from Tonovcov grad showed three basic decoration techniques: incision, impression and modelling techniques.

These techniques could be performed with various tools. Incised decoration can be made by a proper cut (made with a sharp tool with a V shaped profile), groove (U shaped profile) or combing or brush strokes. The differentiation between the latter two is unclear, but in general incisions made with a comb-like tool (Germ. *Kammstrich*, It. *pettine*) are sharper and more regular than those made with a brush (Germ. *Besenstrich*, It. *scopetto*). It is especially hard (sometimes impossible) to distinguish between the two when dealing with irregular decorations on hand-made vessels (Ladstätter 2000, 150). At Tonovcov grad the incised decoration took place before the pottery was fired, which is a general characteristic of Late Antique pottery in the Southeast Alps (Martelli 1995, 121; Ladstätter 2000, 151).

Impression is usually performed by a sharp tool that is pressed into the vessel surface before firing. This can be created with a variety of tools, and on Tonovcov grad the impressions were in most cases created by a short and sharp tool (fingernail, awl). We have also found imprints made with a comb-like tool.



Sl. 4.13: Metličenje (t. 84: 2; foto: M. Zaplatil). M. = 1:1.  
Fig. 4.13: Brush strokes (Pl. 84: 2; photo: M. Zaplatil). Scale = 1:1.

cesarskodobnega obdobja, sčasoma pa je ta povezava vse manjša. Za čas 6. st. naj bi bila značilna popolna prevlada grobega metličjenja (Rodriguez 1992, 168). Izrazito grobo metličenje naj bi bilo v vzhodnih Alpah značilno za zgodnjerednjevješko obdobje.

Nasprotno Tonovcov grad kaže, da se določen tip metličjenja bolj povezuje z določenim tipom posode, kot pa na kronološki razvoj od finega metličjenja proti grobemu.<sup>51</sup> Posebej izrazito je to mogoče opaziti pri skledah. Tu se pojavlja zelo fino, pogosto v več smereh potekajoče metličenje (t. 74: 10; 76: 3-4,8,11,14-15; 79: 1; 82: 9). Tako metličenje je posebej pogosto na skledah tipa 1, posebno 1c (t. 76: 3-4,8,11,14-15), ki so bile najdene v plasteh druge poznoantične faze, pa tudi v zgodnjerednjevjeških plasteh. Vsaj za 6. st. torej lahko govorimo o uporabi dokaj finega metličjenja.

Metličenje je lahko izvedeno tudi bolj grobo, tako da potegi z metlico ali glavnikom tvorijo izrazite brazde. Tudi tovrstno metličenje lahko poteka v več smereh in tvori motiv mreže (sl. 4.13; t. 82: 8; 83: 9-10; 84: 1-5). Grobo navzkrižno metličenje je na Tonovcovem gradu zastopano skoraj izključno na skledah tipa 5 (predvsem 5b), ki se začnejo pojavljati že v plasteh prve poznoantične faze, prevladujejo pa v plasteh druge poznoantične faze, torej v 6. st. Najbližje analogije za ta okras so na Invillinu (Bierbrauer 1987, t. 71: 8; 72: 1-3; 108: 2; 111: 6; 113: 6), kjer se prav tako pojavlja predvsem na skledah, ter na Castelraimodu (Martelli 1995, sl. 10). Izrazito grobo izvedenega metličjenja, ki je značilnost zgodnjerednjevješke keramike na Tirolskem in v Furlaniji (Rodriguez 1992, 172; Ladstätter 2000, 151; Villa 2005, 84, sl. 15), na Tonovcovem gradu ni.

Pri loncih se metličenje pojavlja skoraj pri vseh tipih z izjemo tipov 6 in 7, vendar ni zelo pogosto in

<sup>51</sup> Podobno velja za Sv. Hemo, kjer se na določene tipe posod veže določen način metličjenja, ne glede na kronološki položaj posode (Ladstätter 2000, 151).

Modelling is a process in which bulges are created from vessel walls. In our case most examples were presented by ribs decorated with the pressing technique, and handles that were modelled from vessel walls.

#### BRUSH STROKES OR COMBING

The most common decorative technique at Tonovcov grad was combing or brush strokes, both of which were commonly combined with other decoration types. This decoration type could appear on the outer, inner or on both sides of the vessel. It is more likely to appear on bowls, but it also appears on pots. The lines can run horizontally, obliquely or in multiple directions, thus creating the net motif.

Brush strokes and combing are common on Roman pottery, and in the discussed area they appear already in pre-Roman times. In the Late Roman period this decorative element becomes the most common on coarse ware,<sup>50</sup> and its popularity continues throughout Late Antiquity and into the Early Medieval period. H. Rodriguez presupposed that combing in Late Antiquity evolved from fine to coarse (Rodriguez 1988, 144; 1992, 168-169; 1997, 153-154). Fine brush strokes were supposedly linked to the decorations found in the Early Imperial period, but as time went by this link started to diminish. Coarse brush strokes dominated in the 6<sup>th</sup> century (Rodriguez 1992, 168). In the eastern Alps extremely coarse brush strokes were characteristic of the Early Medieval period.

In opposition the appearance of this ornament at Tonovcov grad indicates that a certain type of brush stroke was linked to a certain vessel type, and not to the chronological development from fine to coarse brush strokes.<sup>51</sup> This was clearly noticed on bowls, where very fine brush strokes appeared, often in multiple directions (Pls. 74: 10; 76: 3-4,8,11,14-15; 79: 1; 82: 9). Such brush strokes were common on type 1 bowls, especially type 1c (Pl. 76: 3-4,8,11,14-15), which were found in Late Antiquity 2 layers, as well as in Early Medieval layers. Relatively fine brush strokes were used at least in the 6<sup>th</sup> century if not longer.

Brush strokes could also be coarser, and the brush or comb-like tool could create pronounced grooves. Such brush strokes could be made in various directions, thus forming the net motif (Fig. 4.13; Pls. 82: 8; 83: 9-10; 84: 1-5). At Tonovcov grad coarse brush strokes in all

<sup>50</sup> In the 4<sup>th</sup> century the popularity of brush strokes was indicated by the example from Hrušica where horizontal, vertical and oblique brush strokes appeared, as well as brush strokes in various directions (Giesler 1981, Pls. 46: 9-16,18-30; 47: 2-8,14-15,20,22,24; 48: 4-12,15-16,18-23,28,31).

<sup>51</sup> Similar holds true for Hemmaberg, where a certain type of brush strokes was applied to certain vessel types, regardless of the chronological position of the vessel (Ladstätter 2000, 151).

ga ne moremo posebej povezati z nobenim oblikovnim tipom. Le izjemoma nastopa metličenje v več smereh (t. 98: 2), pogostejše je vodoravno metličenje.

Metličenje se pogosto povezuje tudi z drugimi okrasnimi tehnikami, predvsem z valovnico.

#### VALOVNICA

Valovnica je okrasni motiv, ki je večinoma izveden v tehniki vrezovanja oziroma žlebljenja. Pogosto se pojavlja skupaj z drugimi tehnikami in motivi (predvsem s horizontalnimi vrezi oz. kanelurami ter metličanjem). Na poznoantični keramiki je bila izvedena z enojnim ali glavničastim orodjem na steno posode pred pečenjem. Spada med najpogostejše motive na poznoantični keramiki v jugovzhodnih Alpah.

Z okrasom valovnice na poznoantični grobi keramiki v jugovzhodnoalpskem prostoru se je v največ ukvarjala Helgard Rodriguez (1986; 1992; 1997). Prvi pojav enojne valovnice na s finim metličanjem okrašeni poznoantični grobi keramiki v jugovzhodnih Alpah je, predvsem zaradi odsotnosti tovrstnega okrasa na Hrušici, postavila v zadnjo tretjino 4. st., povezala pa ga je z vplivom podonavskega prostora (Rodriguez 1992, 166; 1997, 158). S to tezo v nasprotju je predpostavka Ladstätterjeve o regionalnem izvoru oblik in okrasnega spektra poznoantične keramike v jugovzhodnoalpskem prostoru (Ladstätter 2000, 134, 150). Valovnica je sicer poznana že na rimski keramiki zgodnjega cesarstva na tem prostoru, vendar gre pri tej za popolnoma druge oblikovne in tehnološke značilnosti, hkrati pa povsem izgine v obdobju srednjega cesarstva (Rodriguez 1992, 168, op. 29).

Glede nadaljnje razvoja valovnice Rodriguezova predpostavlja (podobno kot pri metličanju) razvoj od finih k bolj grobim oblikam. Tako naj bi bile za 6. st. značilne nepravilne, večlinijske valovnice na grobo glavničanih površinah posode (Rodriguez 1992, 168).



Sl. 4.14: Valovnica (t. 81: 1; foto: M. Zaplatil). M. = 1:1.  
Fig. 4.14: Wavy line (Pl. 81: 1; photo: M. Zaplatil). Scale = 1:1.

directions were almost exclusively found on type 5 bowls (especially 5b), which started to appear in layers of Late Antiquity 1 phase and prevailed in layers of Late Antiquity 2 phase, i.e. in the 6<sup>th</sup> century. The closest analogies were found at Invillino (Bierbrauer 1987, Pls. 71: 8; 72: 1-3; 108: 2; 111: 6; 113: 6), where they appeared mainly on bowls, and at Castelraimondo (Martelli 1995, Fig. 10). No exceptionally coarse brush strokes, characteristic of Early Medieval pottery in Tyrol and Friuli (Rodriguez 1992, 172; Ladstätter 2000, 151; Villa 2005, 84, Fig. 15), were found on Tonovcov grad.

Brush strokes appeared on almost all pot types, with the exception of types 6 and 7; however they were not very common and could not be linked to a specific shape. Brush strokes in various directions appeared only as an exception (Pl. 98: 2); horizontal brush strokes were much more common.

Brush strokes often appeared in combination with other decorative techniques, especially wavy lines.

#### WAVY LINE

Wavy line is a decorative motif performed in the incising or grooving technique. It often appeared in combination with other techniques and motifs (especially with horizontal incisions or grooves and brush strokes). In Late Antiquity it was created with a single or comb-like tool before the pottery was fired. It was one of the most frequent motifs on Late Antique pottery in the Southeastern Alps.

Helgard Rodriguez (1986; 1992; 1997) has written the most studies dealing with the wavy line decoration on Late Antique coarse ware in the Southeastern Alps. In the Southeastern Alps she placed the first appearance of a single wavy line on a coarse ware into the last third of the 4<sup>th</sup> century – mainly due to the lack of such decoration at Hrušica. This decoration was created by fine brush strokes and was linked to the influence from the Danubian area (Rodriguez 1992, 166; 1997, 158). Ladstätter's assumption as regards the regional origin and the decoration spectre of Late Antique pottery in the Southeastern Alps is in contradiction to this thesis (Ladstätter 2000, 134, 150). In this area the wavy line was known from Early Roman pottery, however it had a completely different design and technological characteristics, and it disappeared during the Middle Roman period (Rodriguez 1992, 168, note 29).

Taking into account the further development of the wavy line Rodriguez assumed (similar to brush strokes) that it developed from fine to coarse. Thus irregular multiline wavy lines on coarse combed surfaces were characteristic of the 6<sup>th</sup> century (Rodriguez 1992, 168).

On Tonovcov grad the wavy line appeared in layers belonging to both Late Antiquity phases, as well as to the Early Medieval period. The multiline wavy lines appeared



Sl. 4.15: Metličenje in valovnica (t. 99: 1; foto: M. Zaplatil). M. = 1:1.

Fig. 4.15: Brush strokes and wavy line (Pl. 99: 1; photo: M. Zaplatil). Scale = 1:1.

Na Tonovcovem gradu se valovnica pojavlja v plasteh obeh poznoantičnih faz, pa tudi v zgodnjem srednjem veku. Pri tem se tudi v plasteh prve poznoantične faze, ki sodijo v drugo polovico 4. in začetek 5. st. že pojavlja večlinijska valovnica v kombinaciji z metličanjem oz. glavničanjem.

Z valovnico so večkrat okrašene skledе kot lonci. Pogosto je njeno druženje z drugimi ornamentalnimi tehnikami (metličenje, vbodi, kanelure). Prevladuje enojna valovnica, večlinijska pa se pojavlja predvsem na skledah tipov 2, 3 in 6 (t. 78: 7,9; 80: 1,9–10; 84: 7,10,12). Na skledah tipa 1 se pojavlja izključno enojna valovnica, lahko tudi v pasovih (t. 76: 7,10; 103: 2) in v kombinaciji z metličanjem (t. 74: 2,8). Podobno velja za skledе tipa 1 z Invillina (Bierbrauer 1987, t. 70: 1,3,5,13; 72: 3), Koprа (Cunja 1996, t. 37: 391–392), Križne gore (Ciglencečki 2000, sl. 108: 3,10–11) in Sv. Heme (Ladstätter 2000, t. 14: 5; 56: 5). Zelo lepo je izvedena večlinijska valovnica na dveh skledah tipa 5a (t. 83: 1; 105: 5), nikoli pa se ne pojavlja na skledah tipa 5b.

Pri loncih se valovnica pojavlja predvsem pri tipih 1 in 2 in sicer lahko enojna, več enojnih ali večlinijska valovnica (t. 87: 1,7–8; 88: 1,3–4,8; 89: 1,6,10,13; 90: 1,3; 103: 10). Na loncih se pojavlja večinoma skupaj z metličanjem in horizontalnimi kanelurami (t. 98: 7–13; 99: 1–6), redko pa z vbodi. Pri loncih tipa 6 se samo v enem primeru pojavijo trije pasovi s horizontalnimi kanelurami ločene enojne, dokaj nepravilno izvedene valovnice (t. 104: 3). Valovnice se nikoli ne pojavljajo na loncih tipov 7 in 8.

in combination with brush strokes or combed decoration already in Late Antiquity 1 layers, i.e. the second half of the 4<sup>th</sup> and beginning of the 5<sup>th</sup> century.

Bowls were more likely to be decorated with a wavy line than pots. It often appeared in combination with other decorative techniques (brush strokes, incisions, grooves). The single wavy line prevailed, while multiple lines mainly appeared on bowls types 2, 3 and 6 (Pls. 78: 7,9; 80: 1,9–10; 84: 7,10,12). Type 1 bowls were decorated only with a single wavy line, sometimes appearing in a strip (Pls. 76: 7,10; 103: 2) or in combination with brush strokes (Pl. 74: 2,8). Similar can be said for type 1 bowls from Invillino (Bierbrauer 1987, Pls. 70: 1,3,5,13; 72: 3), Koper (Cunja 1996, Pl. 37: 391–392), Križna gora (Ciglencečki 2000, Fig. 108: 3,10–11) and Hemmaberg (Ladstätter 2000, Pls. 14: 5; 56: 5). The multiple wavy lines on the two type 5a bowls were nicely done (Pls. 83: 1; 105: 5), while this type of decoration never appeared on type 5b bowls.

The wavy line appeared mainly on pot types 1 and 2; it could appear as a single line, a number of single lines or a multiple wavy line (Pls. 87: 1,7–8; 88: 1,3–4,8; 89: 1,6,10,13; 90: 1,3; 103: 10). On most pots the wavy line appeared in combination with brush strokes and horizontal grooves (Pls. 98: 7–13; 99: 1–6), and rarely with impressions. On a single example of a type 6 pot three skips with horizontal grooves divided a relatively irregularly made wavy line (Pl. 104: 3). Wavy lines never appeared on pots types 7 and 8.

A richer wavy line decoration appeared at Tonovcov grad on vessels belonging to Late Antiquity phase 1. These were predominantly multiple wavy lines with a large amplitude (Pls. 78: 7,9; 83: 1; 84: 7,10,12; 105: 5), thus they sometimes transformed into a spruce branch or fishbone motif (Pls. 78: 9; 84: 12). Such wavy lines were often combined with impressions or incisions. This decoration was not as commonly found in Late Antiquity 2 layers (Pls. 80: 10; 90: 1), where a single, irregular wavy line combined with grooves (and rarely with brush strokes) appeared (Pls. 75: 4; 77: 1,6–7; 78: 13,16; 79: 6–7,15–16; 80: 3; 81: 7; 85: 6; 87: 1,7; 93: 1; 99: 2–6; 102: 1,14; 103: 1). In the Early Medieval layers only single line or multiple individual wavy lines appeared; these were usually extended, and were irregular in their shape (Pls. 74: 2; 98: 9; 103: 2,10; 104: 3).

The single wavy line dominated on Ajdna, sometimes it appeared in strips, and it was often combined with other techniques, especially impressions (Ciglencečki 2000, Fig. 123: 1–7,14; 124: 1–3,6–8). The stratigraphic position of the finds is unknown. In Koper the multiple wavy line was rare, for it appeared exclusively on pots that belonged to the first group and were dated into the 5<sup>th</sup> and 6<sup>th</sup> century. On the other hand, the regular single wavy line was relatively common (Cunja 1996, Pl. 33: 354–362). In most cases the pots belonging to the second group (dated after the 7<sup>th</sup> century) revealed a single, gradual and irregular wavy line.

The regular or irregular single wavy line was the most commonly found decoration type on the material

Bogatejši okras valovnice se na Tonovcovem gradu pojavlja na posodah iz prve poznoantične faze. To so večinoma večlinijske valovnice z veliko amplitudo (*t.* 78: 7,9; 83: 1; 84: 7,10,12; 105: 5), tako da včasih prehajajo že v motiv smrekovih vejic oziroma ribje kosti (*t.* 78: 9; 84: 11). Take valovnice so pogosto kombinirane z vbodi in vrezi. V plasteh druge poznoantične faze je tak okras redkejši (*t.* 80: 10; 90: 1). Takrat prevladuje enolinijska, večinoma bolj nepravilno izvedena valovnica, ki je kombinirana samo še s kanelurami in redko metličanjem (*t.* 75: 4; 77: 1,6-7; 78: 13,16; 79: 6-7,15-16; 80: 3; 81: 7; 85: 6; 87: 1,7; 93: 1; 99: 2-6; 102: 1,14; 103: 1). V zgodnjerednjeveških plasteh se pojavlja samo še enojna oziroma več enojnih, precej razvlečenih, nepravilno izvedenih valovnic (*t.* 74: 2; 98: 9; 103: 2,10; 104: 3).

Na Ajdnu prevladuje enojna valovnica, včasih v pasovih, pogosto pa kombinirana z drugimi tehnikami, predvsem vbodi (Ciglencečki 2000, sl. 123: 1-7,14; 124: 1-3,6-8), vendar stratigrafski položaj najdb ni poznan. V Kopru je večlinijska valovnica redka, pojavlja se izključno na loncih, ki pripadajo prvi skupini in so datirani v čas 5. in 6. st., dokaj pogosta pa je pravilna enolinijska valovnica (Cunja 1996, t. 33: 354-362). Na loncih druge skupine, datiranih v čas po 7. st. prevladuje enojna, položna, nepravilno izvedena valovnica.

Med gradivom z Invillina je opazna močna prevlada enojne valovnice, ki je lahko izvedena pravilno ali pa tudi zelo nepravilno (npr. Bierbrauer 1987, t. 70: 2; 82: 10,12; 84: 1,18; 85: 7-9), medtem ko je večlinijska zastopana le izjemoma (Bierbrauer 1987, t. 70: 12).

Na Casteraimondo valovnica ni zastopana (Martelli 1995, 126).

Na Sv. Hemi z valovnico okrašene posode prevladujejo v plasteh druge polovice 6. st., zato avtorica sklepa, da je postal okras valovnice v jugovzhodnoalpskem prostoru prevladujoč šele v teku 6. st. (Ladstätter 2000, 151). Vendar pa poleg Tonovcovega gradu tudi nekaj drugih najdišč v zahodni Sloveniji kaže na to, da je bila valovnica v vseh pojavnih oblikah že v 5. st. priljubljen okras. Tako so poznani z različnimi vrstami valovnice in metličanja bogato okrašeni lonci z Rodika (Ciglencečki 2000, t. 115: 1-2), kjer čas življenja naselbine verjetno ne seže čez sredino 5. st. (Slapšak 1985; Vidrih Perko 1997a; Ciglencečki 2000, 107). Na Kučarju, ki je datiran do konca 5. st., se večlinijska valovnica pojavlja v enem primeru in sicer na izvihanem ustju sklede (J. Dular, Ciglencečki, A. Dular 1995, t. 79: 8), prevladuje pa okras več enojnih valovnic, večkrat tudi na metličeni steni posode. Bogat repertoar različnih valovnic kažeta tudi Predloka (Boltin-Tome 1993, t. 2: 1-7; 3: 1-9) in Križna gora (Ciglencečki 2000, sl. 105: 1,5-6,11; 106: 1-4,9-11), ki pa obe živita tako v 5. kot v 6. st., v Predloki pa se življenje na delu naselja nadaljuje še vsaj do 9. st. (Boltin-Tome 1993, 83). Najdbe stratigrafsko niso umeščene.

Povedano kaže, da zaenkrat ne moremo kronološko določiti posameznih faz v razvoju tega priljubljenega

from Invillino (Bierbrauer 1987, Pls. 70: 2; 82: 10,12; 84: 1,18; 85: 7-9); the multiple wavy line was rare (Bierbrauer 1987, Pl. 70: 12). At Casteraimondo no wavy line decorations was found.

On Hemmaberg vessels decorated with a wavy line dominated in the layers belonging to the second half of the 6<sup>th</sup> century, thus author concluded that the wavy line became dominant in the Southeastern Alps only during the 6<sup>th</sup> century (Ladstätter 2000, 151). However, alongside Tonovcov grad a few other sites in western Slovenia indicate that the wavy line (in all its shapes) was popular already in the 5<sup>th</sup> century. Richly decorated pots with various types of wavy lines and brush strokes were found on Rodik (Ciglencečki 2000, Pl. 115: 1-2), which was most probably not inhabited beyond the mid 5<sup>th</sup> century (Slapšak 1985; Vidrih Perko 1997a; Ciglencečki 2000, 107). On Kučar, which was inhabited until the end of the 5<sup>th</sup> century, the multiple wavy line appeared in a single example, i.e. on an everted rim belonging to a bowl (J. Dular, Ciglencečki, A. Dular 1995, Pl. 79: 8). Individual wavy lines prevailed, often found on vessel walls in combination with brush strokes. The rich repertoire of various wavy lines can also be found at Predloka (Boltin-Tome 1993, Pls. 2: 1-7; 3: 1-9) and Križna gora (Ciglencečki 2000, Figs. 105: 1,5-6,11; 106: 1-4,9-11), both of which were inhabited in the 5<sup>th</sup> as well as 6<sup>th</sup> century. A part of Predloka was inhabited at least until the 9<sup>th</sup> century (Boltin-Tome 1993, 83). The finds were not stratigraphically placed.

All of this indicates that we can as yet not chronologically define the individual phases in the development of this popular Late Antique decoration. The wavy line started to appear in Late Antiquity, one could say at the beginning of the 5<sup>th</sup> century, however a few exceptions can be dated already into the 4<sup>th</sup> century (Rodriguez 1997, 163).

The wavy line does not appear in the neighbouring site of Gradič above Kobarid<sup>52</sup> (similar to Hrušica), which was inhabited at least throughout the 4<sup>th</sup> century (Osmuk 1987; 1997), which is an additional element that leads us to believe that the appearance of the wavy line can be dated into the 5<sup>th</sup> century.

It seems that we can witness a fast development of various forms in certain areas (especially in western and southern Slovenia). These forms included the multiple wavy line soon after it first appeared, while in certain areas (e.g. Friuli) it reached greater popularity only in the Early Medieval period (Lusuardi Siena, Negri, Villa 2004, Figs. 7: 1,3,7,14; 12: 3,5,7-11). In Carinthia it appeared as a dominant decorative motif only in the 6<sup>th</sup> century (Ladstätter 2000, 151).

On hilltop settlements in eastern Slovenia the wavy line was practically the only decoration (apart from the brush strokes) found on Late Antique pottery, while most of it had no decoration at all (Ciglencečki 2000, 139). In

<sup>52</sup> N. Osmuk kindly let me go through the unpublished material that is in preparation for publication.

poznoantičnega okrasa. Začetek pojava valovnice v pozni antiki sicer lahko postavimo na začetek 5. st, z izjemnimi primeri tudi konec 4. st. (Rodríguez 1997, 163).

Med neobjavljenim gradivom sosednjega najdišča Gradič nad Kobaridom,<sup>52</sup> ki živi še vsaj celo 4. st. (Osmuk 1987; 1997) se valovnica ne pojavlja (podobno kot ne na Hrušici), kar je dodaten element za datacijo pojava valovnice v 5. st.

Kaže, da je na določenih območjih (predvsem v zahodni in južni Sloveniji) prišlo do hitrega razvoja različnih oblik, vključno z večlinijsko valovnico, že kmalu po njenem pojavu, medtem ko je drugje (npr. v Furlaniji) dosegla večjo popularnost šele v zgodnjem srednjem veku (Lusuardi Siena, Negri, Villa 2004, sl. 7: 1,3,7,14; 12: 3,5,7-11). Na Koroškem naj bi se kot prevladujoč okrasni motiv pojavila šele v 6. st. (Ladstätter 2000, 151).

Na višinskih naselbinah vzhodne Slovenije je valovnica poleg metličena praktično edini okrasni element poznoantične keramike, medtem ko je večina celo brez okrasa (Ciglencečki 2000, 139). Večinoma se pojavlja samostojno, včasih se druži s horizontalnimi kanelurami.

Valovnica na najstarejši slovanski keramiki ni zastopana, že kmalu pa postane prevladujoč okrasni element. Na vzhodnoslovenskih najdiščih gre večinoma za večlinijsko valovnico, pogosto kombinirano s kanelurami, izvedenimi z glavničastim orodjem (Ciglencečki 2000, 143; novejša najdišča zbrana v Guštin 2002). V zgodnjersrednjeveških kontekstih Furlanije pa prevladuje enojna ali več enojnih, nepravilno izvedenih valovnic z majhno amplitudo (zbrano pri Lusuardi Siena, Negri, Villa 2004). Podobno velja na blejski Pristavi (Belak, Pleterski, Knific 2008, t. 2: 2-3; 3: 1; 5: 2-5,9; 6: 4; 7: 1: 8: 1-3,5; 10: 12; 11: 10,12; 13: 2,13; 14: 1-3,7; 20-22; 23: 1-10).

Govorimo lahko torej o močnih regionalnih značilnostih pri uporabi valovnice v jugovzhodnih Alpah.

Bolj natančno kronološko opredelitev razvoja valovnice na posameznih ožjih območjih bi lahko dala le analiza stratificiranega gradiva z več najdišč, kjer bi lahko sledili razvoju okrasa na enem najdišču.

### ŽLEBLJENJE

Okras horizontalnih vrezov oziroma žlebov na Tonovcovem gradu le redko nastopa samostojno na ostentnih posod (t. 95: 11). Mnogo pogostejši je v kombinaciji z drugimi okrasnimi tehnikami, predvsem z valovnico (glej zgoraj), pa tudi z metličanjem in vbodi.

Pogosto pa je žlebljeno ustje, predvsem to velja za lonce tipov 4 in 5 (t. 91: 16,18; 93: 10-11; 94: 7-8,11,13-15) ter skleda tipa 5 (t. 82: 6-8; 83: 1,4-5).

<sup>52</sup> Pregled gradiva, ki je v pripravi za objavo, mi je prijazen omogočila N. Osmuk.

most cases the wavy line appeared on its own, sometimes in combination with horizontal grooves.

The wavy line was not found on the oldest Slav pottery, however it soon became the most common decorative element. In eastern Slovenian sites the multiple wavy line was the most common; this was often combined with grooves that were made with a comb-like tool (Ciglencečki 2000, 143; newer sites collected in Guštin 2002). In the Early Medieval contexts in Friuli a single, irregularly made wavy line or more wavy lines with a small amplitude were found (collected at Lusuardi Siena, Negri, Villa 2004). Similar can be said for the Pristava in Bled (Belak, Pleterski, Knific 2008, Pls. 2: 2-3; 3: 1; 5: 2-5,9; 6: 4; 7: 1: 8: 1-3,5; 10: 12; 11: 10,12; 13: 2,13; 14: 1-3,7; 20-22; 23: 1-10).

In the Southeastern Alps we can thus talk about strong regional characteristics in the use of the wavy line.

A more precise chronological classification of the wavy line development in individual narrower areas could only be given through an analysis of stratigraphed materials from all sites, for this would enable us to follow the development of the decoration through time on each individual site.

### GROOVES

On Tonovcov grad horizontal incisions or grooves rarely appeared on the vessels walls on their own (Pl. 95: 11). In most cases they appeared in combination with other decorative elements, especially the wavy line (see above), but also with brush strokes or impressions.

The rims were often grooved, especially in pot types 4 and 5 (Pls. 91: 16,18; 93: 10-11; 94: 7-8,11,13-15) and bowl type 5 (Pls. 82: 6-8; 83: 1,4-5).

### IMPRESSIONS AND INCISIONS

This decoration was relatively common on Tonovcov grad. In most cases it was found on the vessel walls, but it was also commonly found on the rim, the base or the rib. Most impressions were created with a short, sharp object (fingernail, awl).

Impressions and incisions were linked to a specific vessel type. Thus impressions were mainly found on rims belonging to type 2 (Pl. 78: 5-6), type 3 (Pls. 79: 9; 80: 6; 81: 1-2,7-14) or type 6 (Pl. 84: 10) bowls.

A series of somewhat longer and narrower incisions were also found. These were more commonly found on pot walls, especially on pots type 1 (Pls. 87: 3, 8; 89: 3,13) and 4 (Pls. 91: 15; 92: 14), however, they also appeared on bowls (Pl. 82: 4).

Impressions and incisions often appeared in combination with other types of decoration. Impressions were often made over the combing or brush stroke patterns and were combined with the wavy line. This holds especially



## VBODI IN VREZI

Ta okras je na Tonovcovem gradu dokaj pogost. Večinoma je bil izveden v ostenje posode, pogosti pa so tudi vbodi na ustju in dnu ter na plastičnem rebu. Prevladujejo vbodi s kratkim, ostrim predmetom (noht, šilo).

Tudi vbodi in vrezji se vežejo na določen tip posode. Tako so z vbodi razčlenjena ustja skled tipa 2 (*t.* 78: 5–6), 3 (*t.* 79: 9; 80: 6; 81: 1–2, 7–14) in 6 (*t.* 84: 10).

Pojavljajo se tudi nizi nekoliko daljših, ozkih vrezov. Ti so pogostejši na ostenjih loncev, predvsem tipa 1 (*t.* 87: 3,8; 89: 3,13) in 4 (*t.* 91: 15; 92: 14) pojavljajo pa se tudi na skledah (*t.* 82: 4). Vbodi in vrezji se pogosto družijo z drugimi vrstami okrasa. Mnogokrat so vbodi izvedeni preko glavničenja oz. metliččenja in kombinirani z valovnico. Posebno velja to za skledje tipa 3, kjer je lahko s kombinacijo metliččenja, valovnice in vbodov oz. vrezov okrašeno celo ostenje posode (*t.* 80: 1,13).

Okras se pojavlja tudi na Invillinu, vendar tu prevladuje oblika daljših poševnih nizov na ostenjih posode, medtem ko so z vbodi razčlenjena ustja redka (Bierbrauer 1987, *t.* 70: 8,10; 71: 6; 72: 7; 73: 12; 75: 7,12; 78: 7; 91: 7; 108: 4,7,12; 109: 2,13; 110: 5,8,10; 111: 1,9,14–15; 112: 12,14; 114: 15,18; 115: 2; 116: 12; 117: 1,6,13; 122: 1; 123: 1–2). Tonovcovemu gradu soroden način okraševanja odebeljenih ustij skled najdemo na Castelraimundu (Covizzi 1995, *t.* 12: C 1995, C 2007; 13: C 2949, C 2122; 14: C 1044; 15: C 1989), pojavljajo pa se tudi vbodi v ostenje posod – predvsem skled (Covizzi 1995, *t.* 6: C 1357; 11: C 6039; 14: C 1689, C 2866).

Na kraških in primorskih najdiščih je ta okras redek. Zelo pogost pa je na Ajdni, kjer se poševno postavljeni kratki vrezji pogosto sestavljajo v motiv ribje kosti (Meterc 1981, *t.* 1: 3,6,8; Ciglencečki 2000, *sl.* 123: 3,14; 124: 1,6).

Na Sv. Hemi se pojavlja tako na loncih (Ladstätter 2000, *t.* 12: 1; 13: 7,10; 20: 6; 32: 1) kot na skledah (Ladstätter 2000, *t.* 16: 6) in je včasih kombiniran z drugimi vrstami okrasa (valovnica, žlebljenje: Ladstätter 2000, *t.* 51: 1), čeprav tudi tu ni zaslediti za Tonovcov grad tipičnega z vrezji razčlenjenega ustja skled.

Precejšnjo sorodnost z okrasom s Tonovcovega gradu kaže sicer precej oddaljeni Lavant, kjer je pogosto z vrezji oziroma vbodi okrašeno ustje skled (Rodriguez 1984, *sl.* 1: 1–2,6–8,10), pojavlja pa se tudi razčlenjen zunanji rob dna (Rodriguez 1984, *sl.* 2: 7–8). Podobno velja za gradivo iz le nekoliko bližjega Duela (Steinklauber 1990, *sl.* 7, 12, 14).

Okras nizov kratkih vrezov je poznan tudi z najdišča Kappel (Felgenhauer-Schmiedt 1993, *t.* 26: 4; 33: 2, 28: 9 – razčlenjen rob dna), vbodov pa s Teurnije (Rodriguez 2000, *t.* 1: 6) in Kirchbichla (Rodriguez 2000, *t.* 10: 97; 11: 99,101–102).

Od vzhodnje ležečih najdišč je poznan primer z Brinjeve gore z nizom vbodov pod ustjem skledje (Ciglencečki 2000, *sl.* 95: 1).

true for type 3 bowls, where the entire vessel wall could be covered in a combination of brush strokes, wavy lines and impressions or incisions (*Pl.* 80: 1,13).

This decoration was also found at Invillino, however here the most common were vessel walls decorated by a long slanting series of impressions, while rims with impressions were rare (Bierbrauer 1987, *Pls.* 70: 8,10; 71: 6; 72: 7; 73: 12; 75: 7,12; 78: 7; 91: 7; 108: 4,7,12; 109: 2,13; 110: 5,8,10; 111: 1,9,14–15; 112: 12,14; 114: 15,18; 115: 2; 116: 12; 117: 1,6,13; 122: 1; 123: 1–2). A similar type of decoration on thickened rims as found on Tonovcov grad was also discovered at Castelraimondo (Covizzi 1995, *Pls.* 12: C1995, C2007; 13: C 2949, C 2122; 14: C 1044; 15: C 1989), and impressions also appeared on vessel walls, especially on bowls (Covizzi 1995, *Pls.* 6: C 1357; 11: C 6039; 14: C 1689, C 2866).

This type of decoration was rare in the Karst and in the coastal sites. However, it was extremely common on Ajdna, where the obliquely positioned short incisions were often placed into a fishbone pattern (Meterc 1981, *Pl.* 1: 3,6,8; Ciglencečki 2000, *Figs.* 123: 3,14; 124: 1,6).

On Hemmaberg it appeared on pots (Ladstätter 2000, *Pls.* 12: 1; 13: 7,10; 20: 6; 32: 1) and bowls (Ladstätter 2000, *Pl.* 16: 6) and was sometimes combined with other decorations (wavy lines, grooves: Ladstätter 2000, *Pl.* 51: 1), however, none of the articulated bowl rims characteristic of Tonovcov grad were found here.

Relative similarity with the decorations from Tonovcov grad was shown by the rather distant Lavant, where bowl rims were often decorated with incisions or impressions (Rodriguez 1984, *Fig.* 1: 1–2,6–8,10), and a divided outer base edge was also found (Rodriguez 1984, *Fig.* 2: 7–8). Similar can be said for the materials from the only slightly closer Duel (Steinklauber 1990, *Figs.* 7, 12, 14).

Decoration in the form of a series of short incisions was also discovered at Kappel (Felgenhauer-Schmiedt 1993, *Pls.* 26: 4; 33: 2; 28: 9 – divided base edge), while a series of impressions were found in Teurnia (Rodriguez 2000, *Pl.* 1: 6) and Kirchbichl (Rodriguez 2000, *Pls.* 10: 97; 11: 99,101–102).

Further to the east a bowl with a series of impressions below the rim was discovered on Brinjeva gora (Ciglencečki 2000, *Fig.* 95: 1).

On Tonovcov grad two base fragments were discovered, both decorated with short incisions or imprints on the interior (*Pl.* 99: 15–16). The incisions were positioned in the shape of a circle or a double circle. In Carinthia the base interior was often decorated. Incisions, impressions and wavy lines appeared, and they formed a concentric circle, the interior of which was often decorated with a cross (which could be formed in a variety of ways). Such examples were found on Hemmaberg, Kappel, Teurnia and Lavant (collected at Ladstätter 2000, 153–156, *Fig.* 64, with the literature quoted there).

On Tonovcov grad the decoration was made with short incisions, while in Carinthia it was made in the

Na Tonovcovem gradu sta bila najdena tudi dva fragmenta dna, okrašena s kratkimi vrezi oziroma žigi na notranji strani dna posode (*t. 99: 15–16*). Vrezi so postavljeni v obliki kroga oz. dvojnega kroga.

Okras na notranji strani dna je pogost na koroških najdiščih. Tu se pojavljajo vrezi, vbodi in valovnice, ki tvorijo koncentrični krog, katerega notranjost je pogosto okrašena z na različne načine izvedenim križem. Taka dna so bila najdena na Sv. Hemi, Kapelli, Teurniji in Lavantu (zbrano pri Ladstätter 2000, 153–156, sl. 64, s tam citirano literaturo).

Primeri s Tonovcovega gradu se od koroških razlikujeta po načinu izvedbe okrasa s kratkimi vrezi, okras koroških najdišč pa je izveden z glavničastim orodjem v obliki vbodnih linij. Zaradi slabe ohranjenosti primerov s Tonovcovega gradu ne moremo sklepati o okrasu v notranjosti kroga. Tako še vedno velja, da okras žigosanega križa na dnu posode s slovenskih in severnoitalijanskih najdišč zaenkrat ni poznan (Ciglencečki 2000, 140; Ladstätter 2000, 155, op. 981).

Primeru s Tonovcovega gradu tako še najbolj ustreza dno krožnika z Vranja, ki je ravno tako okrašeno s pasovi kratkih, radialno postavljenih vrezov (Mirnik-Prezelj 1984, t. 33: 290).

Vzor za vrezan oziroma žigosan okras na dnu posode lahko iščemo na sigilatnem posodju. Predvsem posode, okrašene z rastlinskimi in geometrijskimi motivi v stilu Hayes A II in Hayes A III, so v 5. st. pogoste najdbe na obravnavanem prostoru (Pröttel 1996, 61). Za okras križa pa S. Ladstätter predpostavlja vzore v kovinskem posodju. Z žigosanim okrasom križa okrašena sigilata namreč ni poznana z najdišč jugovzhodnoalpskega prostora, poleg tega način izvedbe okrasa na koroških primerih spominja na tremolirni vrez kovinskih posod (Ladstätter 2000, 155).

En primer (*t. 99: 15*) lahko na podlagi njegove lege v plasti faze PA 1 postavimo v čas druge polovice 4. oziroma začetka 5. st., medtem ko je bil drugi (*t. 99: 16*) najden v plasteh druge poznoantične faze.

Na Tonovcovem gradu je zelo skromno zastopan okras vbodov, izvedenih z glavničastim orodjem, ki navadno potekajo v obliki poševnih nizov (*t. 99: 7*). Gre za značilen okras zgodnjerednjeveške keramike v Sloveniji (Ciglencečki 2000, 144, t. 37: 17–19), na sv. Hemi se tak okras pojavi že v plasteh 6. st., značilen naj bi bil za začetek 7. st. (Ladstätter 2000, 153). Na Tonovcovem gradu se pojavlja v poznoantični plasti.

#### TRAKOVI IN REBRA

Rebra so lahko aplicirana (prilepljena) na posodo, lahko pa izvlečena iz stene posode.

Na Tonovcovem gradu prevladuje plastičen trak, prilepljen na ostenje posode, pojavlja pa se tudi modeliranje rebra iz stene posode. Pri obeh načinih gre tudi za uporabno funkcijo. Rebra namreč olajšujejo prenos

form of impressed lines with a comb-like tool. Due to the poor condition of the examples from Tonovcov grad we cannot conclude as regards the decoration within the circle. The impressed cross on the base is still unknown in Slovenian and north Italian sites (Ciglencečki 2000, 140; Ladstätter 2000, 155, note 981).

The most similar to the example from Tonovcov grad is the plate base from Vranje, which was also decorated with strips of short, radially positioned incisions (Mirnik-Prezelj 1984, Pl. 33: 290).

The model for the carved or imprinted decoration on the vessel base can be sought for amongst Red Slip Ware. In the 5<sup>th</sup> century vessels decorated with vegetable and geometric motifs in the style Hayes A II and Hayes A II, were especially common finds in the discussed area (Pröttel 1996, 61). S. Ladstätter assumes that the cross decoration was adopted from metal containers, while Red Slip Ware with a stamped decoration of the cross is unknown in the Southeastern Alps. The manner in which the decoration on the Carinthian examples was executed is reminiscent of the tremolo incisions found on metal vessels (Ladstätter 2000, 155).

On the basis of its position in Late Antiquity 1 layer we can date one example (*Pl. 99: 15*) into the second half of the 4<sup>th</sup> or beginning of the 5<sup>th</sup> century, while the other (*Pl. 99: 16*) was found in a Late Antiquity 2 layer.

On Tonovcov grad the decoration in the form of impressions (most commonly positioned in an oblique shape) created with a comb-like tool was very rare (*Pl. 99: 7*). In Slovenia this type of decoration was characteristic for Early Medieval pottery (Ciglencečki 2000, 144, Pl. 37: 17–19). Hemmaberg such decoration appeared already in the 6<sup>th</sup> century layers, however it only became characteristic at the beginning of the 7<sup>th</sup> century (Ladstätter 2000, 153). On Tonovcov grad it was found in a Late Antique layer.

#### STRIPS AND RIBS

Ribs can be applied (stuck) to the vessel, or pulled out from the vessel walls.

At Tonovcov grad the most common technique was attaching a strip to the vessel wall, however in some examples the rib was modelled from the vessel walls. Both examples also show a functional use. The ribs made it easier to carry the vessel (Buora, Casani 2002, 59), and they could also be formed into a handle (*Pl. 86: 5–6*). Ribs were rarely undecorated (*Pl. 99: 14*), and most commonly they were decorated with incisions or impressions. The poorly preserved fragments with this decoration do not allow us to conclude as regards the types of vessels upon which this decoration was applied.

Ribs on vessel walls were a common decoration in Friuli, where they were most commonly found on bowls (Invillino: Bierbrauer 1987, Pls. 117: 8; 130: 1; 131: 2–3; Castelraimondo: Covizzi 1995, Pls. 12: C 2599, C 2630;



Sl. 4.16: Dno z reliefnimi rebri (t. 99: 19; foto: M. Zaplatil).  
Fig. 4.16: Rib-decorated vessel base (Pl. 99: 19; photo: M. Zaplatil).

posode (Buora, Casani 2002, 59), lahko so tudi oblikovana v držaj (t. 86: 5–6). Rebra so le redko neokrašena (t. 99: 14), prevladujejo z vrezi oz. vbodi okrašeni trakovi. Slaba ohranjenost fragmentov s tem okrasom ne dopušča sklepanja o tipih posod, na katere je bil apliciran.

Plastična rebra na ostenjih posod so pogost okras na področju Furlanije, kjer prevladujejo na skledah (Invillino: Bierbrauer 1987, t. 117: 8; 130: 1; 131: 2–3; Castelraimondo: Covizzi 1995, t. 12: C 2599, C 2630; 13: C 2121; Vidulis: Rupel 1988, št. 28; Coseano: Rupel 1988, št. 92–105; Sclaunico: Buora, Casani 1998, sl. 2: 1; Iutizzo: Buora, Casani 1998, sl. 2: 2–3), poznana pa so tudi z obalno-kraških najdiščih (Predloka: Boltin Tome 1993, t. 3: 9). S trakovi okrašene posode v Furlaniji prevladujejo na najdiščih 4. in 5. st. Rebra se tam pojavljajo v kombinaciji z metličanjem, nikoli pa v kombinaciji z valovnico (Buora, Cassani 2002, 61).

Z reliefnimi rebri je lahko okrašeno tudi dno posod na spodnji strani (t. 99: 17–21). Večinoma tvorijo obliko križa v krogu. Tak okras je dokaj pogost na vsem jugovzhodnoalpskem in severnojadranskem prostoru. Poznan je iz Kopra (Cunja 1996, t. 38: 399), s Korinjskega hriba (Ciglencečki 1984, sl. 8), Kučarja (J. Dular, Ciglencečki, A. Dular 1995, t. 79: 2; 83: 7), Tinja (Ciglencečki 1984, sl. 7), z Vranja (Mirnik-Prezelj 1984, t. 25: 240) in s Sv. Heme (Ladstätter 2000, t. 53: 3–4; sl. 65). V Furlaniji je bil najden na Invillinu (Bierbrauer 1987, t. 93: 16; 103: 13; 117: 10–11, 15–16), v Osoppu, Artegna, S. Daniele del Friuli, Čedadu, San Giorgiu, Sclavons di Cordenon, Gradežu in Oderzu (zbrano pri Lusuardi Siena, Negri 2007).

Večina dnov posod, okrašenih z reliefnimi rebri, je bilo na Tonovcovem gradu najdenih v plasteh, ki sodijo v drugo poznoantično fazo, torej v 6. st., en primer pa je

13: C2 121; Vidulis: Rupel 1988, No. 28; Coseano: Rupel 1988, Nos. 92–105; Sclaunico: Buora, Casani 1998, Fig. 2: 1; Iutizzo: Buora, Casani 1998, Fig. 2: 2–3). They were also known from the coastal and Karst sites (Predloka: Boltin Tome 1993, Pl. 3: 9). In Friuli vessels decorated with ribs were most commonly found in 4<sup>th</sup> and 5<sup>th</sup> century sites, where ribs appeared in combination with brush strokes, but never in combination with the wavy line (Buora, Cassani 2002, 61).

In some cases ribs were used to decorate the vessel base (Pl. 99: 17–21). Most commonly they formed the shape of a cross within a circle. This type of decoration was relatively common throughout the Southeastern Alps and the northern Adriatic. It was discovered in Koper (Cunja 1996, Pl. 38: 399), at Korinjski hrib (Ciglencečki 1984, Fig. 8), Kučar (J. Dular, Ciglencečki, A. Dular 1995, Pls. 79: 2; 83: 7), Tinje (Ciglencečki 1984, Fig. 7), Vranje (Mirnik-Prezelj 1984, Pl. 25: 240) and Hemmaberg (Ladstätter 2000, Pl. 53: 3–4; Fig. 65). In Friuli it was found at Invillino (Bierbrauer 1987, Pls. 93: 16; 103: 13; 117: 10–11, 15–16), in Osoppo, Artegna, S. Daniele del Friuli, Cividale del Friuli, San Giorgio, Sclavons di Cordenon, Grado and Oderzo (collected at Lusuardi Siena, Negri 2007).

Most rib-decorated vessel bases from Tonovcov grad were found in Late Antiquity 2 layers, and can thus be dated into the 6<sup>th</sup> century, however a single example was found in an Early Medieval layer. On Hemmaberg bases decorated with ribs appeared in layers belonging to the second half of the 6<sup>th</sup> century, and none were found in 5<sup>th</sup> century layers (Ladstätter 2000, 157). In Friuli the earliest examples were dated into the 5<sup>th</sup> century, however they reached the peak of their popularity in the 6<sup>th</sup> and 7<sup>th</sup> century (Lusuardi Siena, Negri 2007, 185, Pl. 1). This type of decoration was known already in the Late Roman period, when it was commonly found in the area of the Danubian limes (Ladstätter 2000, note 989).<sup>53</sup> The movement of the decoration into the Southeastern Alps and Friuli could be linked to the Late Antique movements of the inhabitants (Lusuardi Siena, Negri 2007, 197).

This decoration spanned over a long time, for in Slovenia it also appeared on 8<sup>th</sup> and 9<sup>th</sup> century Slav pottery. It was found in cemeteries Dobova – Humeck (Knific 2002, 123, Fig. 20) and Zgornji Duplek (Knific 2002, 124, Figs. 22, 26) and in settlement Pristava in Bled (Belak, Pleterski, Knific 2008, Pl. 15: 1–2, 11–12).

The temporal caesura between the Antique examples and its reintroduction in Slav contexts (in the 8<sup>th</sup> and 9<sup>th</sup> century) is supposedly proof for the contact and cohabitation of the original settlers and the newly arrived Slavs (Lusuardi Siena, Negri 2007, 197).

<sup>53</sup> S. Lusuardi Siena and A. Negri assumed that the model for this decoration derived from the ornaments on the Alano-Sarmatian metal mirrors that were supposedly developed in the military contexts on the limes, where it was assumed that it represented a sign for a certain ethnic group within a multi ethnic community (Lusuardi Siena, Negri 2007, 197).

poznan tudi iz zgodnjerednjeveške faze. Na Sv. Hemi se dna, okrašena z rebri, pojavljajo v plasteh druge polovice 6. st., medtem ko jih v plasteh 5. st. ni (Ladstätter 2000, 157). V Furlaniji so najzgodnejši primeri datirani v 5. st., prevladujejo pa v 6. in 7. st. (Lusuardi Siena, Negri 2007, 185, t. 1). Okras reber na dnu posode je sicer poznan že v poznorimskem obdobju, kjer je pogost na območju donavskega limesa (Ladstätter 2000, op. 989).<sup>53</sup> Prenos okrasa na območje jugovzhodnoalpskega prostora in Furlanije naj bi bil povezan s premiki prebivalstva v poznoantičnem obdobju (Lusuardi Siena, Negri 2007, 197).

Rebra na dnu posode so dolgotrajen okras, saj se pojavljajo tudi na slovanski keramiki 8. in 9. st. Poznana so npr. z grobišč Dobova - Humek (Knific 2002, 123, sl. 20) in Zgornji Duplek (Knific 2002, sl. 22, 26) ter iz naselbine na blejski Pristavi (Belak, Pleterski, Knific 2008, t. 15: 1–2, 11–12).

Časovna cezura med antičnimi primeri in ponovnim pojavom v slovanskih kontekstih 8. in 9. st. naj bi bila tudi dokaz za stik in sobivanje staroselskega prebivalstva s slovanskimi prišleki (Lusuardi Siena, Negri 2007, 197).

## 4.3 SKLEP

### 4.3.1 TONOVCOV GRAD

Pregled keramičnega gradiva na Tonovcovem gradu po stavbah pokaže, da ga je bilo daleč največ najdenega na območju stavbe 1, ki je bila opredeljena kot bivalna. Tu je bil zastopan pester sklop uvožene keramike iz prve in druge poznoantične faze ter velika količina grobe keramike iz obeh poznoantičnih faz in tudi iz zgodnjega srednjega veka.

Uvožena keramika, ki jo časovno lahko uvrstimo v prvo poznoantično fazo (afriški importi, glazirana keramika, navadna namizna keramika) je bila večinoma najdena v plasteh, ki tudi stratigrafsko pripadajo obdobju pred gradnjo stavbe 1, nekaj pa je je bilo tudi pomešane v plasteh druge poznoantične faze. V zgodnjerednjeveških plasteh se importi afriškega izvora ne pojavljajo. Vzhodnosredozemske amfore pa so bile najdene skoraj izključno v plasteh, ki pripadajo drugi poznoantični fazi, nekaj skromnih primerov iz zgodnjerednjeveških plasti lahko označimo kot rezidualne. Opazna pa je prostorska koncentracija vzhodnosredozemskih amfor ob zidu 4 stavbe 1, zato na tem mestu morda lahko domnevamo skladišče uvoženega blaga (glej pogl. 4.1.7, sl. 4.8).

Groba keramika prve poznoantične faze ne kaže nobenih posebnih značilnosti glede razporeditve po prostoru, najdena je bila po vsem izkopnem polju. V

<sup>53</sup> S. Lusuardi Siena in A. Negri predpostavljata vzor za ta okras v ornamentiki alano-sarmatskih kovinskih zrcal, razvil pa naj bi se v vojaških kontekstih na limesu, kjer naj bi pomenil znak za določeno etnično skupino znotraj večnacionalne skupnosti (Lusuardi Siena, Negri 2007, 197).

## 4.3 CONCLUSION

### 4.3.1 TONOVCOV GRAD

At Tonovcov grad the pottery overview by buildings has revealed that most of the material (by far) was discovered in the excavation area of building 1, which was defined as living quarters. This area revealed a rich selection of imported pottery from Late Antiquity phases 1 and 2 as well as a large selection of coarse ware dated to both Late Antiquity phases as well as to Early Middle Ages.

Most of the imported pottery that could be dated into Late Antiquity 1 phase (African imports, glazed pottery, common tableware) was discovered in layers that also stratigraphically belong to the period before building 1 was built, while some of it was mixed in Late Antiquity 2 layers. Imports of African origin did not appear in Early Medieval layers. Eastern Mediterranean amphorae were found almost exclusively in Late Antiquity 2 layers, while the few modest examples found in the Early Medieval layers were classified as residual finds. It had been noticed that the finds of Eastern Mediterranean amphorae were concentrated on the outer side of the wall 4 of building 1, thus it can be assumed that this was the location of a warehouse for imported goods (see chapter 4.1.7, Fig. 4.8).

Late Antiquity 1 coarse ware did not show any special characteristics as regards its location within the area, as it was found throughout the excavation area. In phase LA 2 the dispersion was rather uneven, as a large quantity of finds was discovered in the area in front of the entrance into building 1 (Qus. 716, 717/A1, 717/A2, 666, 667), while in the building itself these finds were not as common. This fitted the general image as regards the distribution of finds within the excavation area of building 1, as small non-pottery finds were also most common in the vicinity of the building (Tonovcov grad. Settlement remains and interpretation, Fig. 3.15).

In the excavation area of building 1 the Early Medieval period was relatively reliably documented merely with the layers in the building interior, from where most of the coarse ware from this phase originates (Tonovcov grad. Settlement remains and interpretation, Fig. 3.16).

Most of the pottery found within ecclesiastical complex could be dated into Late Antiquity phase 1 and into the Early Middle Ages. LA 1 phase was documented with a few modest finds under the mortar floors of the north and main church. The churches' demolition layers revealed some Early Medieval pottery. Finds that could be categorised as belonging to Late Antiquity 2 (due to their technological and typological characteristics) were rare and found in demolition layers.

Buildings 2 and 3 show a very different picture as regards their pottery inventory.

Building 3 is the best preserved building from phase Late Antiquity 1 at Tonovcov grad. The finds were not numerous, but the inventory was similar to that from the

fazi PA 2 je razporeditev ravno tako precej enakomerna, opazna je le velika količina najdb na prostoru pred vhodom v stavbo 1 (Kv. 716, 717/A1, 717/A2, 666, 667), medtem ko v sami hiši ni tako številna. To ustreza splošni sliki razprostranjenosti najdb v izkopnem polju stavbe 1, saj so tudi nekeramične drobne najdbe prevladovala v okolici stavbe (Tonovcov grad. Naselbinski ostanki in interpretacija, sl. 3.15)

Zgodnjerednjeveško obdobje je bilo v izkopnem polju stavbe 1 dokaj zanesljivo dokumentirano le s plastmi v notranjosti objekta in iz njih izvira večina grobe keramike te faze (Tonovcov grad. Naselbinski ostanki in interpretacija, sl. 3.16)

Na območju cerkvenega sklopa sta v keramičnem gradivu zastopani predvsem prva poznoantična in zgodnjerednjeveška faza. Faza PA 1 je bila z nekaj skromnimi najdbami dokumentirana pod estrihi severne in osrednje cerkve. V ruševinski plasti cerkva je bila najdena tudi zgodnjerednjeveška keramika. Najdbe, ki jih glede na tehnološke in tipološke značilnosti lahko pripišemo drugi poznoantični fazi, so redke, pa še te izvirajo iz ruševinskih plasti.

Stavbi 2 in 3 kažeta glede keramičnega inventarja dokaj različno sliko.

Stavba 3 je na Tonovcovem gradu zaenkrat najbolje ohranjen objekt iz prve poznoantične faze. Najdbe sicer niso številne, vendar gre za podoben inventar kot v plasteh prve poznoantične faze na območju stavbe 1 (lonci tipa 7, skleda tipa 5b, afriške amfore). V plasteh, ki so prekrile razrušeno stavbo 3, je zastopana tudi druga poznoantična faza, ki jo lahko povežemo s časom življenja sosednje stavbe 2.

V stavbi 2 je bilo odkritega izredno malo keramičnega gradiva (vsega skupaj okrog 30 značilnih kosov), med njim pa je kar tretjina uvožene keramike. Zastopani so odlomki afriške sigilate ter nekaj vzhodnosredozemskih amfor. Groba keramika je zaradi skromnega števila težko opredeljiva, kaže pa značilnosti druge poznoantične faze (skleda tipa 3a). Majhno število keramičnih najdb in njihova dokaj nenavadna sestava (razmeroma velika količina uvoženega gradiva) kaže na nebivalni značaj stavbe 2.

V cisterni je bilo najdb malo. V ruševini, ki je zapolnjevala cisterno, je bilo najdenih le nekaj netipičnih fragmentov ostenj grobe keramike. V žganinski plasti na dnu, torej v plasti, ki je nastala po koncu uporabe cisterne v njeni prvotni funkciji, pa je bilo najdenih nekaj fragmentov, ki so po tipoloških in tehnoloških značilnostih sorodni keramiki iz zgodnjerednjeveških plasti v stavbi 1 in v cerkvenem sklopu.

#### 4.3.2 POZNOANTIČNA KERAMIKA NA OBMOČJU SLOVENIJE IN FURLANIJE

Uvoženo posodje je v poznoantičnem obdobju indikator trgovskih stikov provinc v notranjosti s Sredo-

Late Antiquity 1 phase in the excavation area of building 1 (pots type 7, bowls type 5b, African amphorae). Late Antiquity 2 finds were present in layers that covered the demolished building 3. These finds could be linked to the period in which the neighbouring building 2 was inhabited.

Extremely low quantities of pottery were discovered in building 2 (in total approximately 30 diagnostic pieces), one third of which represented imported pottery. The imports consisted of African Red Slip Ware and a few Eastern Mediterranean amphorae fragments. Due to the low numbers the coarse ware was hard to define, however it showed Late Antiquity 2 characteristics (bowl type 3a). The low numbers of pottery finds and their relatively unusual composition (relatively large quantity of imported material) indicated that building 2 was not used for living quarters.

The cistern revealed very few finds. Amongst the ruins that filled the cistern, only a few non-typical fragments of coarse ware walls were found. In the charred layer at the bottom, i.e. in the layer that emerged after the cistern was no longer used in its primary function, a few fragments were found that were similar (in their typological and technological characteristics) to the pottery found in the Early Medieval layers in building 1 and in the ecclesiastical complex.

#### 4.3.2 LATE ANTIQUE POTTERY IN SLOVENIA AND FRIULI

In Late Antiquity imported vessels were an indicator of the trade connections between the inland provinces and the Mediterranean. Their presence indicated that these contacts remained (at least to a certain measure) and the need for imported goods reflected the certain civilizational level of the inhabitants who still desired Mediterranean goods and were also capable of obtaining them (cf. Villa 1998, 286).

Coarse kitchen ware of predominantly local production was a product used in everyday lives, and not an object of exchange over long distances. Certain similarities in the shapes and decoration with the relatively distant locations can be explained with the exchange of influences, possibly also craftsmen and the movements of individuals, and not necessarily trade.

As we are discussing a relatively long, historically diverse period, it should be clear that we cannot speak of a unified supply of pottery throughout this period.

In the second half of the 4<sup>th</sup> and in the beginning of the 5<sup>th</sup> century most of the imported goods reached the Southeastern Alps via Aquileia and other large northern Adriatic ports. Most imports of the period were represented by African amphorae, African Red Slip Ware, African oil lamps and African kitchen ware. Amphorae were used to transport goods linked to the annona – wine,

zemskim prostorom. Njegova prisotnost dokazuje, da so ti stiki do neke mere še vedno živi, potreba po uvoženem blagu pa kaže tudi na določeno civilizacijsko stopnjo prebivalstva, ki si je še vedno želelo sredozemske dobrine in jih je bilo tudi sposobno pridobiti (prim. tudi Villa 1998, 286).

Po drugi strani je grobo kuhinjsko posodje večinoma lokalne izdelave izdelek za vsakdanjo uporabo, ki ni bil predmet izmenjave na daljše razdalje. Nekatere sorodnosti v oblikah in okrasu posod iz medsebojno dokaj oddaljenih krajev si je mogoče razlagati bolj z izmenjavo vplivov, morda tudi z izmenjavo obrtnikov in selitvijo posameznikov, ne pa s trgovino.

Ker obravnavamo dokaj dolgo, zgodovinsko pestro časovno obdobje, pa je jasno, da ne moremo govoriti o enotnem načinu oskrbe s keramiko skozi ves ta čas.

V drugi polovici 4. in začetku 5. st. je uvoženo blago v jugovzhodne Alpe prihajalo predvsem prek Akvileje in ostalih večjih severnojadranskih pristanišč. Glavnina uvoza v tem času predstavljajo afriške amfore, ki jih spremlja afriška sigilata, oljenke, pa tudi afriško kuhinjsko posodje. V amforah je prihajalo blago, povezano z anono – vino, olje in garum. V jugovzhodnih Alpah spadajo med najpogostejše najdbe različne variante amfor tipov Keay 25 in Keay 26, ki naj bi bile glede na posmoljeno notranjost v uporabi predvsem za vino (Bonifay 2004, 122, 129). Pojavljajo se tudi velike cilindrične amfore, npr. Keay 27, 35 in 36. Omenjeni importi so pogosti v obmorskih mestih, kot sta Akvileja in Tergeste (Aquileia 1991; 1994; Maselli Scotti et al. 2004), v centrih v notranjosti, kot sta Emona in Celeja, pa tudi na območju sistema *Claustra Alpium Iuliarum* in naselij v njihovem zaledju (Vidrih Perko 2000). Tu so tovrstni importi povezani z oskrbo vojaških posadk. Naselja v zaledju opravljajo obrambno funkcijo tudi še po propadu zapor okrog leta 400, saj uvoženo blago vanje prihaja nekje do sredine 5. st. (Vidrih Perko 2000, 447; Vidrih Perko, Župančič 2005, 521–522). Podobno sliko glede afriških importov kaže tudi Tonovcov grad, kar potrjuje njegovo dokaj pomembno (verjetno obrambno) funkcijo konec 4. in v začetku 5. st.

Na višinskih naseljih v osrednji in vzhodni Sloveniji so afriški importi redkejši.

V tem času se pojavljajo tudi importi iz vzhodnega Sredozemlja, predvsem egejske amfore LR 3, ki pa prevladujejo v zahodnem delu jugovzhodnih Alp in v večjih centrih.

Od sredine 5. st. dalje je na podeželskih najdiščih zahodne Slovenije opazno nenadno prenehanje afriškega uvoza, večina naselbin pa je opuščenih (Vidrih Perko, Župančič 2003, 464). Podobno domnevamo za Tonovcov grad, kjer prav tako ni poznano tipično gradivo druge polovice 5. st.

V 6. st. v vsem Sredozemlju, pa tudi v notranjosti, prevladuje keramika vzhodnosredozemskega izvora, v prvi vrsti amfore, pa tudi sigilatna LRC produkcija (Reynolds 1995, Bonifay, Piéri 1995; Murialdo 2007). Na

oil and garum. In the Southeastern Alps the most commonly found were amphorae types Keay 25 and Keay 26, for which it is assumed that they were used mainly for transporting wine – due to their resin-covered interior (Bonifay 2004, 122, 129). Large cylindrical amphorae also appear, for instance Keay 27, 35 and 36. The mentioned imports are common in coastal towns such as Aquileia and Tergeste (Aquileia 1991; 1994; Maselli Scotti et al. 2004), in centres in the interior, such as Emona and Celeia, as well as in the area of the *Claustra Alpium Iuliarum* and the settlements in its vicinity (Vidrih Perko 2000). These imports were linked to the supply of military posts. The settlements in the hinterland served a defensive function also once the defence line fell (around 400 AD), which is clearly indicated by the imported goods that kept coming until the mid 5<sup>th</sup> century (Vidrih Perko 2000, 447; Vidrih Perko, Župančič 2005, 521–522). A similar image as regards African imports was indicated by Tonovcov grad, which confirms its relatively important (most likely defensive) function at the end of the 4<sup>th</sup> and beginning of the 5<sup>th</sup> century.

African imports were not as common in hilltop settlements in central and eastern Slovenia.

In this period Eastern Mediterranean imports appeared throughout the entire Southeastern Alpine area. Most common were Aegean amphorae LR 3, which dominated in the "western part of the discussed area and in larger centres.

In the mid 5<sup>th</sup> century African imports were no longer imported into rural sites in western Slovenia, and most settlements were abandoned (Vidrih Perko, Župančič 2003, 464). A similar scenario can be assumed for Tonovcov grad, as no material that would be characteristic of the second half of the 5<sup>th</sup> century was discovered.

Throughout the 6<sup>th</sup> century the Mediterranean and the interior were flooded by Eastern Mediterranean pottery, primarily amphorae, but also LRC ware (Reynolds 1995, Bonifay, Piéri 1995; Murialdo 2007). In the north Adriatic these imports were numerous in coastal towns such as Koper (Cunja 1996) and Piran (Vidrih Perko 1994a), as well as in smaller settlements such as for instance Savudrija (Vidrih Perko, Župančič 2005) and Fazine (Gaspari et al. 2007). The relatively high numbers of these imports indicate the existence of an organised overseas trade network at least until the mid 7<sup>th</sup> century. It is highly probable that the settlements in the interior were supplied from these coastal settlements.

In this period a similar composition of imported pottery was noticed in hilltop settlements in Friuli (Invillino, Udine, Attimis, Osoppo, Iulium Carnicum), central and eastern Slovenia (Ajdna, Bašelj, Vranje, Rifnik, Korinjski hrib, Kučar, Tinje, Kranj and Črnomelj) and in Carinthia (Hemmaberg, Duel, Teurnia); however compared to coastal towns their numbers were much lower. It was assumed that these examples were no longer a result of organised trade, but a result of individual imports of

severnem Jadranu so ti importi zelo številni v obalnih mestih, kot sta Koper (Cunja 1996) in Piran (Vidrih Perko 1994a), pa tudi v manjših naseljih, npr. Savudrija (Vidrih Perko, Župančič 2005) in Fizine (Gaspari et al. 2007). Dokajšnja številčnost teh importov kaže na obstoj organizirane prekomorske trgovske mreže vsaj do sredine 7. st. Iz teh obalnih naselij so se verjetno oskrbovala tudi naselja v notranjosti.

Podobno sestavo uvoženega posodja v tem času lahko zasledimo tudi na višinskih naseljih v Furlaniji (Invillino, Videm, Attimis, Osoppo, *Iulium Carnicum*), v osrednji in vzhodni Sloveniji (Ajdna, Bašelj, Vranje, Rifnik, Korinjski hrib, Kučar, Tinje, Kranj in Črnomelj) ter na Koroškem (Sv. Hema, Duel, Teurnija), vendar je njihovo število skromnejše kot na obalnih najdiščih. Postavljena je bila teza, da naj v teh primerih ne bi šlo več za sledi organizirane trgovine, ampak prej za individualen prinos določenih artiklov, morda ob posebnih priložnostih.<sup>54</sup> Kljub temu se zdi, da precejšnje število in raznolikost amfor 6. st. tudi v notranjosti kaže na obstoj vsaj do neke mere organizirane trgovine.<sup>55</sup> Tudi analiza, ki jo je opravil Lucca Villa za Furlanijo, kaže predvsem na višinskih utrjenih naselbinah v času 6. in začetka 7. st. dokaj podobno sestavo inventarja uvoženega posodja in njegovo precejšnjo raznolikost, kar naj bi kazalo na centralno organizirano in vodeno oskrbo (Villa 1998, 286).<sup>56</sup>

Organizirano oskrbo v 6. st. je na obravnavanem območju lahko izvajala državna (vojaška) ali pa cerkvena oblast, ki je v poznem obdobju v veliki meri skrbelo tudi za delovanje državnih služb.

Povezavo z vojaško oblastjo za proizvodnjo in trgovino nekaterih amfor (npr. LRA 1, LRA 2) zaradi njihove dokaj standardizirane oblike domnevajo denimo za podonavski limes (Abadie-Reynal 1989; Curta 2001; Opař 2004a; Pieri 2005). LRA 1 in LRA 2 sta tudi na Tonovcovem gradu najbolj pogosti vzhodnomediterranski amfori. Podobno velja za pozne male spatejone, ki jih povezujejo z zgodnjebizantinsko utrditvijo kastelov ob Donavi v 6. in prvi polovici 7. st. (Mackensen 1992, 247, 251). Na Jadranu in v zaledju pa se kaže povezava amfor tipa Samos-cisterna z utrjenimi bizantinskimi kastrumi (Arthur 1990, 290, sl. 4).

Zelo pogosta najdba na obravnavanem območju v času 6. in 7. st. so tudi pozni mali spatejoni. Pogosti so v obalnih mestih (Koper, Piran), pa tudi na višinskih naseljih v notranjosti. Na Invillinu sodijo med najpogostejše zastopane amfore (Mackensen 1987), po več

certain articles, maybe on special occasions.<sup>54</sup> However, it seems that the high numbers and diversity of 6<sup>th</sup> century amphorae in the interior indicates the existence of organised trade (at least to a certain extent).<sup>55</sup> The analysis that Lucca Villa performed for Friuli showed a relatively similar composition of imported vessels inventory and their relative diversity in fortified hilltop settlements in the 6<sup>th</sup> and beginning of the 7<sup>th</sup> century, which supposedly indicates a centralised organisation and a managed supply (Villa 1998, 286).<sup>56</sup>

In the 6<sup>th</sup> century organised supply could have been performed by the state (military) or church authorities (which were in the later period to a great extent in charge of state services).

Due to the relatively standardised forms it was assumed that the production and trade with certain amphorae (LRA 1, LRA 2) was controlled by the military authorities (e.g. in the Danubian limes, Abadie-Reynal 1989; Curta 2001; Opař 2004a; Pieri 2005). LRA 1 and LRA 2 were the most common Eastern Mediterranean amphorae also at Tonovcov grad.

Similar holds true for the late small spatheia, which were linked to the Early Byzantine fortification of settlements along the Danube river (which took place in the 6<sup>th</sup> and beginning of the 7<sup>th</sup> century; Mackensen 1992, 247, 251). In the Adriatic and in the hinterland a connection between Samos-cystern type amphorae and fortified Byzantine settlements was observed (Arthur 1990, 290, Fig. 4).

Small late spatheia were a common find in the 6<sup>th</sup> and 7<sup>th</sup> century. They were common in coastal towns (Koper, Piran), as well as in hilltop settlements in the interior. In Invillino they were one of the best represented amphorae (Mackensen 1987), and numerous examples were also found at Vranje (Knific 1994), Rifnik (Knific 1994, Pl. 7: 4,6; Bausovac 2010, Fig. 3: 7-14) and Križna gora (Urleb 1974).

In this period it was also possible that the church provided the settlements in the interior with Mediterranean goods.<sup>57</sup> The thesis as regards the connection between the church and the supply of amphorae to Late Antique settlements in the interior was in a way con-

<sup>54</sup> Prva je to tezo izrekla v zvezi z najdbami mediteranskih importov na Svetih gorah P. Korošec, kasneje jo delno povzame tudi Verena Vidrih Perko (1994b, 271, op. 4).

<sup>55</sup> Razprostranjenost tovrstnega blaga ne samo na območjih pod bizantinsko oblastjo, ampak tudi na ozemljih, naseljenih z germanskimi ljudstvi, naj bi kazalo moč bizantinske talasokracije v ekonomiji 6. in 7. st. (Murialdo 2007, 14-15).

<sup>56</sup> L. Villa poudarja tudi pomembno vlogo prebivalcev teh naselij in njihovega povpraševanja po uvoženem blagu.

<sup>54</sup> The first to come up with this thesis in relation to Mediterranean imports on Svete gore was P. Korošec, and later Verena Vidrih Perko adopted it to a certain extent (1994, 271, note 4).

<sup>55</sup> As these goods were widespread not only in areas under Byzantine government, but also in territories settled by Germanic tribes, this supposedly indicates the Byzantine dominance in the 6<sup>th</sup> and 7<sup>th</sup> century sea trade (Murialdo 2007, 14-15).

<sup>56</sup> L. Villa emphasised the important role of the inhabitants from these settlements and their demand for imported goods.

<sup>57</sup> In Late Antiquity the church increasingly took over food production as well as the production of amphorae and the trade with the two (Bernal Casasola 2010, 19-25).

primerov je poznanih iz Vranja (Knific 1994), Rifnika (Knific 1994, t. 7: 4,6; Bausovac 2010, sl. 3: 7–14) in Križne gore (Urleb 1974).

Druga organizacija, ki bi v tem poznem obdobju lahko vodila oskrbo naselij v notranjosti z blagom iz Sredozemlja, je bila cerkev.<sup>57</sup> Tezo o povezavi cerkvene organizacije z oskrbo z amforami na poznoantičnih naseljih v notranjosti na neki način potrjuje tudi zakop spatejona skupaj z Justinijanovim novcem ob oltar osrednje cerkve na Tonovcovem gradu. Na posebno (verjetno liturgično) vsebino kaže tudi majhna prostornina poznih spatejonov. Seveda se pri tem postavlja vprašanje, ali je s pomočjo cerkvene mreže prineseno blago na teh naselbinah bilo tudi porabljeno pretežno v liturgične namene, ali pa je kaj od njega prišlo tudi na "prosti trg".

Pot, po kateri je prihajalo uvoženo blago na zahodnoslovenska in furlanska naselja, je verjetno vodila prek obalnih mest, kot so npr. Koper, Gradež in Marano (Cunja 1994, Villa 1998, Malaguti et al. 2007) in manjših naselij, npr. Fizine in Savudrija (Vidrih Perko, Župančič 2005; Gaspari et al. 2007, 185). Za oskrbo naselij v vzhodnem delu današnjega slovenskega ozemlja pa je mogoče domnevati tudi kopensko oziroma tako imenovano podonavsko pot (Mackensen 1992, 245–251).

Grobo kuhinjsko posodje na vseh poznoantičnih višinskih naseljih kaže izredno pestrost in številčno močno prevladuje nad ostalimi vrstami keramike. Analiza inventarja s Tonovcovega gradu je pokazala, da se znotraj enega najdišča v grobem da določiti razvoj keramičnih oblik v pozni antiki in na prehodu v srednji vek, vendar je potrebno, da analiza temelji na dovolj velikem vzorcu.

Težja je primerjava med različnimi najdišči. Otežuje jo predvsem velika raznolikost oblik in faktur, pa tudi različne stopnje raziskanosti in objave posameznih najdišč. Nekatera so raziskana in objavljena skoraj v celoti (npr. Invillino), pri drugih pa je poznan le skromen izbor gradiva, navadno brez ožjih časovnih kontekstov. Previdnost pri primerjavah je potrebna tudi zaradi dolgega življenja nekaterih tipov, ki se lahko na različnih območjih pojavljajo v zelo različnih obdobjih (npr. skleda tipa 1c, lonci tipov 1, 4 ...).

Poleg tega gre pri poznoantični grobi keramiki za lokalno proizvodnjo, omejeno na eno najdišče, čeprav lahko domnevamo menjavanje posameznih posod med bližnjimi naselbinami (Ciglencečki 2000, 60; Ladstätter 2003, 833).

Kljub omejenosti proizvodnje grobe keramike pa lahko vsaj do začetka 5. st. še vedno sledimo oblikam posod in okrasa, ki se pojavljajo na širšem jugovzhodnoalpskem in severnojadranskem območju in kažejo na do neke mere organizirano proizvodnjo. Določeni tipi (npr. skleda tipov 1a in 1b, 2, 4 ter lonci tipov 1, 4 in 5)

<sup>57</sup> V pozni antiki je cerkvena organizacija vse bolj prevzemala že samo produkcijo hrane, pa tudi produkcijo amfor in trgovino s temi izdelki (Bernal Casasola 2010, 19–25).

firmied by the burial of the spatheion with the Justinian coin next to the altar in the main church at Tonovcov grad. The special (most likely liturgy) contents were indicated by the small volume of the late spatheion. Of course, the question arises whether the goods brought to these settlements by the church were predominantly used for liturgy purposes or did some of them also appear on the 'open market'.

The route used to supply western Slovenia and Friuli with imported goods most likely ran through coastal towns, such as Koper, Grado and Marano (Cunja 1994, Villa 1998, Malaguti et al. 2007), as well as smaller settlements such as Fizine and Savudrija (Vidrih Perko, Župančič 2005; Gaspari et al. 2007, 185). The settlements in the Eastern part of current day Slovenia were most likely supplied via a ground or the so-called Danubian route (Mackensen 1992, 245–251).

In all Late Antique hilltop settlements coarse kitchen ware showed extreme diversity and was the most numerous of all pottery types. The analysis carried out on the inventory at Tonovcov grad has shown that it is possible to roughly define the development of pottery types during Late Antiquity and the transition into the Middle Ages within a single site, however the analysis needs to be performed on a large enough sample.

It is more difficult to compare different sites. It is made harder by the great variety of shapes and fabrics, as well as the various levels of research and publications on individual sites. Some have been researched and published almost in their entirety (e.g. Invillino), while for others only a modest selection of the finds is known, usually without precise temporal contexts. When performing comparisons one needs to be cautious also due to the long lifespan of certain types which can appear in different periods in different areas (e.g. type 1c bowls, type 1, 4 pots, etc.).

When dealing with Late Antique pottery we have to keep in mind that we are dealing with local production that is limited to a single site, even though we can assume that individual pieces were exchanged between neighbouring settlements (Ciglencečki 2000, 60; Ladstätter 2003, 833).

Regardless of the limitations of coarse ware we can follow the shapes and decorations in the broader South-eastern Alps and North Adriatic at least until the beginning of the 5<sup>th</sup> century and conclude that the production was organised at least to some extent. Certain types (e.g. bowls types 1a and 1b, 2, 4 and pots types 1, 4 and 5) appear in Friuli, on Tonovcov grad, as well as in sites in central and eastern Slovenia. Most of these vessels were of relatively high quality (TG 1, 2, 8).

The last period (4<sup>th</sup> maybe beginning of the 5<sup>th</sup> century) at the closest site – Gradič above Kobarid – partially coincides with the Late Antiquity phase 1 at Tonovcov grad, and shows some similarities as well as differences. Pot types 1–5 were found, however it was surprising how



se pojavljajo v Furlaniji, na Tonovcovem gradu, pa tudi na najdiščih osrednje in vzhodne Slovenije. Posode teh tipov so večinoma izdelane dokaj kvalitetno (TS 1, 2, 8).

Najbližje najdišče Gradič nad Kobaridom, katerega zadnje obdobje (4., morda začetek 5. st.) se delno prekriva s prvo poznoantično fazo na Tonovcovem gradu, kaže nekaj podobnosti, pa tudi nekaj razlik. Najdeni so bili lonci tipov 1–5, presenetljivo pa je zastopanih malo skled, ki so zelo pogoste v fazi PA 1 na Tonovcovem gradu. Zastopane so sklede tipa 1, 6 in 7. Popolnoma manjkajo na Tonovcovem gradu v prvi poznoantični fazi prevladujoče sklede tipov 2 in 3 kar morda kaže, da jih lahko na Tonovcovem gradu postavimo bolj v končna desetletja prve poznoantične faze.

Zelo pogoste analogije za sklede tipa 3 pa so na Invillinu (sklede tipov Invillino Ib in Ih, Bierbrauer 1987, 208), kjer se pojavljajo v plasteh konca 4. in začetka 5. st. Poznane so tudi na drugih furlanskih najdiščih (Castelraimondo, Vidulis, Coseano). Take sklede so v osrednji in vzhodni Slovenije redke. Podobno lokalno omejenost na Furlanijo in zahodno Slovenijo kažejo tudi sklede tipa 5b. Pri teh lokalno omejenih oblikah je že opazna slabša kakovost izdelave, ki pa vendar do neke mere še kaže na obrtni način (izdelava na ročnem kolesu, žganje v kontrolirani atmosferi).

Dokaj velike razlike med različnimi območji se že v tem času kažejo v ornamentu. Večlinijska valovnica, ki je na Tonovcovem gradu v plasteh prve poznoantične faze že močno zastopana, je praktično neznana na Invillinu in Castelraimondu tako v 5. kot v 6. st. Za koroška najdišča je značilna šele od sredine 6. st. dalje (Ladstätter 2000, 151). Po drugi strani je večlinijska valovnica pogosta na obalno-kraških najdiščih. Predloka in Križna gora časovno sicer nista natančneje opredeljeni, pojav take valovnice na Rodiku (Ciglencečki 2000, sl. 115: 2) pa sodi po dataciji najdišča v prvo polovico 5. st. Na Furlanijo je omejen okras širokega navzkrižnega metličjenja, ki je na Tonovcovem gradu večinoma izveden na skledah tipa 5b.

V 6. st. je med najdišči opaznih že več razlik. Tonovcov grad spet kaže podobne značilnosti kot najdišča v Furlaniji. Večina oblik iz faze PA 1 se nadaljuje, nov pa je pojav loncev s spodrezanim ustjem ter skled tipa 1c. Predvsem lonci s spodrezanim ustjem (tip Tonovcov grad 4a, 4b in 5) sodijo tudi na Invillinu (tip Invillino III d–f) med najpogostejše zastopane oblike (Bierbrauer 1987, 208). Podobno sliko kaže tudi Koper, kjer so zastopani lonci Tonovcov grad 4a in sklede tipa 1a–c.

Posode kažejo še dokaj kvalitetno, vendar ne enotno izdelavo. Večinoma so izdelane iz trdo žgane, neporozne gline, z obilnimi dodatki, žgane pa so lahko v redukcijski ali oksidacijski atmosferi (TS 1, 2, 8). Bolj izrazito pa se začnejo pojavljati grobo izdelane, porozne, večinoma nekontrolirano žgane posode (TS 9, 10), kar že kaže na določeno stopnjo samooskrbe s kuhinjskim posodjem.

Dokaj drugačno sliko v tem času kažejo višinska naselja v vzhodnem delu Slovenije (Vranje, Tinje, Gradec

rare bowls were, as these seem to be popular during the LA 1 phase on Tonovcov grad. Bowls type 1, 6 and 7 were found. No bowls type 2 and 3 were found, even though these were the most popular types on Tonovcov grad in Late Antiquity 1 phase. This could indicate that the ones found on Tonovcov grad should be dated to the last decades of Late Antiquity 1 phase.

A lot of analogies for type 3 bowls were found at Invillino (bowls type Invillino Ib and Ih, Bierbrauer 1987, 208), where they appeared in the layers belonging to the end of the 4<sup>th</sup> and beginning of the 5<sup>th</sup> century. They were also found in other sites in Friuli (Castelraimondo, Vidulis, Coseano), but were rare in central and eastern Slovenia. Bowls type 5b were also found only in Friuli and western Slovenia. These local shapes show poor quality, however they do show a certain extent of craftsmanship (production on a hand-spun pottery wheel, firing in a controlled atmosphere).

Relatively large differences in decorations were noticed between the various areas. In the 5<sup>th</sup> and 6<sup>th</sup> century the multiple wavy line, which had a strong presence in Late Antiquity 1 layers at Tonovcov grad, was practically unknown on Invillino and Castelraimondo. In Carinthian sites the wavy line became characteristic only in the mid 6<sup>th</sup> century (Ladstätter 2000, 151). On the other hand, the multiple wavy lines were common in the coastal and Karst sites. Predloka and Križna gora were not precisely dated, but the appearance of such a wavy line on Rodik (Ciglencečki 2000, Fig. 115: 2) was dated into the first half of the 5<sup>th</sup> century (taking into account the date of the site). The broad criss-cross brush stroke decoration that was on Tonovcov grad predominantly found on type 5b bowls can only be found in Friuli.

The sites show greater diversity in the 6<sup>th</sup> century. Tonovcov grad shows similar characteristics as the sites in Friuli. Most shapes that were known in LA 1 continued, however pots with an undercut rim and bowls type 1c appeared anew. Pots with an undercut rim (types Tonovcov grad 4a, 4b and 5) were one of the most commonly represented forms also at Invillino (type Invillino III d–f; Bierbrauer 1987, 208). The situation was similar in Koper, where pots Tonovcov grad 4a and bowls type 1a–c were found.

The discovered vessels showed a relatively high quality, but non-unified production. Most of them were made from hard fired, non-porous clay, with few large mineral inclusions, and were oxidation or reduction fired (TG 1, TG 2, TG 8). Coarsely made, porous, mainly uncontrolled fired vessels started to appear in higher numbers (TG 9, TG 10), and this indicated a relative level of self-supply with kitchenware.

A slightly different image was shown by the hilltop settlements in east Slovenia (Vranje, Tinje, Gradec near Prapretno, Rifnik). There types appeared that were unknown or rarely found in the west, while on the other hand some types that were common in Friuli failed to appear.

pri Prapretnem, Rifnik). Tam se pojavljajo tipi, ki na zahodu niso poznani ali so zelo redki, hkrati pa na njih niso zastopani nekateri, v Furlaniji pogosti tipi.

Na Koroškem je v drugi polovici 6. st. opazen upad števila oblikovnih tipov, saj so zastopani v glavnem samo nizki trebušasti lonci z izvihanim ustjem in široko stojno ploskvijo (Ladstätter 2000, 139).

V 6. st. je precejšnja sprememba glede na prejšnje faze opazna pri okrasu. Tudi v tem času je razvoj okrasa po posameznih območjih različen. Na Tonovcovem gradu se število okrašenih posod zmanjša, okras postane bolj skromen, skoraj popolnoma izgine večlinijska valovnica, prevladujoča postane enojna, nepravilno izvedena valovnica. V Furlaniji je valovnica še naprej številčno skromno zastopana. Pojavijo pa se nekatere nove vrste okrasa, npr. plastična rebra na dnu posod. Popolno nasprotje v tem času pomenijo koroška najdišča, kjer so posode v drugi polovici 6. st. bogato okrašene z različnimi vrstami valovnic, glavničenja, vrezov in vbodov.

Vzhodnoslovenska najdišča tudi v času 6. st. kažejo le skromen repertoar okrasa (predvsem enojna valovnica in kanelure).

Konec 6. in v začetku 7. st. se na vzhodnem in osrednjem delu današnjega slovenskega ozemlja ter na Koroškem pojavijo prvi sledovi slovanske poselitve. Najstarejša slovanska poselitvena faza je bila v zadnjem času prepoznana na več najdiščih v okolici Murske Sobote, v Hočah, Dragomlju, Gorenjem Mokronogu (zbrano v: Guštin 2002) in na Sv. Hemi (Ladstätter 2000; 2003).

Ta, najstarejša slovanska faza, v zahodnem delu Slovenije in v Furlaniji ni zastopana. Na večini višinskih naselij je kontinuirana poselitev segla še v prvo polovico 7. st., kot kažejo predvsem nekateri pozni sredozemski importi (Lusuardi Siena, Negri, Villa 2004; Murialdo 2007). Po tem času pa uvoz popolnoma preneha. Iz tega konteksta izstopa samo najdba dveh prostoročno izdelanih lončkov z Mosta na Soči, ki sta bila najdena v jami sredi prazgodovinskega grobišča (Mlinar 2002, 111) in kažeta značilnosti zgodnje slovanske lončenine, vendar njuna ožja časovna opredelitev ni mogoča.

Na naseljih je poantična faza do sedaj poznana na Tonovcovem gradu, Invillinu, v Concordiji, Ossopo – San Pietro, Ragogni, San Daniele dei Friuli, Attimis in Ovaru. Na nekaterih od teh najdišč (Tonovcov grad, Concordija, Osoppo – San Pietro) se domneva krajša prekinitev v poselitvi. Na večini naselij je tako ponovna poselitev postavljena v čas od 8. st. dalje, nekatera pa kažejo tudi še poselitev v drugi polovici 7. st. (glej tudi Tonovcov grad. Naselbinski ostanki in interpretacija, pogl. 2.2).

V keramičnem gradivu je v tem času opazen upad števila oblik – ostanke predvsem oblike, namenjene pripravi in shranjevanju hrane, skoraj povsem pa izgine namizno posodje. Pojavi se tudi močna regionalizacija proizvodnje (Lusuardi Siena, Negri, Villa 2004, 79).

Na Tonovcovem gradu se tipi loncev, zastopani v prvih dveh fazah, v zgodnjem srednjem veku pojavljajo

In the second half of the 6<sup>th</sup> century a decline in the shapes was noticed in Carinthia, where mainly low body shaped pots with an everted rim and a broad base were found (Ladstätter 2000, 139).

A large change in the decoration was noticed in the 6<sup>th</sup> century. The decoration developed differently in different areas. The number of decorated bowls on Tonovcov grad fell, the decoration became more modest, the multiple wavy line disappeared almost completely, and the irregular single wavy line became the most common decoration. In Friuli the wavy line continued to be rare. Some new decorations appeared, for instance ribs on the base. The Carinthian sites were completely different, for in the second half of the 6<sup>th</sup> century the vessels were richly decorated with various wavy lines, combings, incisions and impressions.

Sites in east Slovenia showed a modest decoration repertoire in the 6<sup>th</sup> century (mainly single wavy lines and grooves).

At the end of the 6<sup>th</sup> and beginning of the 7<sup>th</sup> century the first traces of Slav settlement appeared in the eastern and central part of current day Slovenia and in Carinthia. The oldest Slav settlement phase was recently recognised in the vicinity of Murska Sobota, in Hoče, Dragomelj, Gorenji Mokronog (collected in: Guštin 2002) and at Hemmaberg (Ladstätter 2000; 2003).

This, the oldest Slav phase, did not reach west Slovenia and Friuli. Certain Late Mediterranean imports clearly indicate that most hilltop settlements were continuously inhabited until the first half of the 7<sup>th</sup> century. Following this period the imports stop completely. Two handmade pots from Most na Soči stand out, both of which were found in a pit in the middle of a prehistoric burial site (Mlinar 2002, 111) and show characteristics of Early Slav pottery; however it was impossible to date them precisely.

The post-Antiquity phase has so far been discovered at Tonovcov grad, Invillino, in Concordia, Ossopo – San Pietro, Ragogna, San Daniele dei Friuli, Attimis and Ovaro. A short gap in the inhabitation was assumed for some of these sites (Tonovcov grad, Concordia, Osoppo – San Pietro). Most of these settlements were repopulated in the 8<sup>th</sup> century or later, however some show that they were inhabited in the second half of the 7<sup>th</sup> century (see also Tonovcov grad. Settlement remains and interpretation, chapter 2.2).

There was a noticeable decline in the number of pottery shapes during this period – mainly shapes used for food preparation and conservation remained, while tableware disappeared almost completely. The production was strongly regionalised (Lusuardi Siena, Negri, Villa 2004, 79).

At Tonovcov grad pot types represented in the first two phases appeared in the Early Middle Ages in modest numbers and can be defined as residual finds. Totally new is the appearance of pot type 6, i.e. pots with a distinc-

le še v zelo skromnem številu in jih lahko opredelimo kot rezidualne kose. Popolnoma na novo nastopijo lonci tipa 6, to je lonci z izrazito usločenim vratom ter dolgim horizontalnim ali poševnim ustjem. Ti so skoraj vedno neokrašeni (ena izjema z enojnimi, s kanelurami ločenimi valovnicami je bila najdena v žganinski plasti osrednje cerkve), pa tudi njihova faktura je popolnoma drugačna od predhodnih. Izrazito prevladujeta tehnološki skupini TS 9 in 10, to je posodje grobe fakture, žgano v nekontrolirani atmosferi, ki kaže na uporabo lončarskih kop. Izrazita novost je pojav TS 5, to je grobe porozne keramike, pri kateri je površina glajena, tako da je otip "masten" oziroma "voščen", površina pa svetleča. Taka površina je značilna za posodje na slovanskih ozemljih in jo Pleterski in Belakova postavljata kot dokaz za prenos lončarskih tehnik Slovanov k staroselcem (Pleterski, Belak 2002, 102). Glajena površina je pogosta tudi v zgodnesrednjeveški fazi v Furlaniji (Lusuardi Siena, Negri, Villa 2004, 83). Na Sv. Hemi je groba, porozna keramika "milnatega" otipa pripisana staroselski fazi 7. st. (Ladstätter 2000, 160; 2003, 854).

Analogije za lonce tipa 6 so sicer poznane po širokem območju jugovzhodnih Alp tako v poznoantičnih kot v zgodnesrednjeveških kontekstih (glej pogl. 4.2.2), vendar predvsem v povezavi z določenimi tehnološkimi skupinami kažejo na čas zgodnjega srednjega veka (Villa 2003, 300; Lusuardi Siena, Negri, Villa 2004, sl. 7: 3; 10: 1-3).

Podobni lonci so bili najdeni tudi v Koprju (Cunja 1996, t. 34; 35: 374-376), kjer so večinoma okrašeni z enojno ali več enojnimi, nepravilnimi valovnicami. Sodiijo v drugo skupino, ki je glede na odsotnost importirane keramike v najdiščnih kontekstih ravno tako datirana v čas po 7. st. (Cunja 1996, 125).

Z ta čas so v Furlaniji značilni tudi lonci z izrazito trakastim ustjem (tip Invillino III f4: Bierbrauer 1987, t. 76: 9-10; 120: 14-19; Lusuardi Siena, Negri, Villa 2004, sl. 8-9). Na Tonovcovem gradu ustrezajo nekaterim primerom tipa 5 (t. 93: 9-11; 94: 3-4), ki se pojavijo že v drugi poznoantični fazi.

Med skledami se iz prvih faz nadaljujejo skledje (pekve) tipa 1, predvsem oblike z razširjenim oziroma odebeljenim robom ustja (Lusuardi Siena, Negri, Villa 2004, sl. 7: 11; 12: 1-7). Novost so kotlički s presega-jočim trikotnim ročajem z luknjo (Bierbrauer 1986, t. 124:10; Lusuardi Siena, Negri, Villa 2004, sl. 4: 1; 13: 1-2; Pleterski 2008, sl. 1.4: 3; 4.92), ki so pogoste v severnoitalijanskih kontekstih 9. in 10. st, ena pa je bila najdena tudi na Tonovcovem gradu (t. 106: 11). Dokaj pogosti so tudi krožniki, ki pa se prav tako lahko pojavijo že v 6. st., nadaljujejo pa se še v zgodnesrednjeveških kontekstih (Lusuardi Siena, Negri, Villa 2004, sl. 7: 13). Dva sta bila najdena tudi na Tonovcovem gradu (t. 85: 6; 105: 8).

Med ornamentalnimi tehnikami v Furlaniji prevladuje enojna valovnica z majhno amplitudo, pogosto izvedena zelo nepravilno, medtem ko je na slovanskih najdiščnih vzhodne in osrednje Slovenije prevladujoča

tively arched neck and a long horizontal or oblique rim. These pots were hardly ever decorated (one exception with individual wavy lines separated by grooves was found in the charred layer of the main church) and their fabric was completely different from the previous ones. Technological groups TG 9 and 10 were by far the most common; these were vessels made from coarse fabric, fired in uncontrolled atmosphere, which indicated the use of pottery piles. A novelty was the appearance of TG 5, i.e. porous coarse ware with a smoothed and shiny surface that was 'greasy' or 'waxy' to the touch. Such a surface was characteristic for pottery found in Slav territories and Pleterski and Belak used it as proof that pottery techniques were transferred from Slavs to the autochthonous settlers (Pleterski, Belak 2002, 102). The smoothed surface was also common in the Early Medieval phase in Friuli (Lusuardi Siena, Negri, Villa 2004, 83). At Hemmaberg the coarse porous pottery 'soapy' to the touch was ascribed to the autochthonous settler's phase in the 7<sup>th</sup> century (Ladstätter 2000, 160; 2003, 854).

Analogies for type 6 pots can be found across the broader Southeastern Alps in Late Antique and Early Medieval contexts (see chapter 4.2.2), however mainly they were connected to certain technological groups linked to the Early Medieval period (Villa 2003, 300; Lusuardi Siena, Negri, Villa 2004, Figs. 7: 3; 10: 1-3).

Similar pots were found in Koper, where most of them were decorated by a single or multiple separated irregular wavy lines. These belong into the second group, which was – taking into account the absence of imported pottery – also dated into the time after the 7<sup>th</sup> century (Cunja 1996, 125).

In Friuli pots with a distinctive strip decoration were characteristic for this period (type Invillino III f4: Bierbrauer 1987, Pls. 76: 9,10; 120: 14-19; Lusuardi Siena, Negri, Villa 2004, Figs. 8-9). At Tonovcov grad they correspond to some type 5 examples (Pls. 93: 9-11; 94: 3-4), which appeared already in Late Antiquity phase 2.

Type 1 bowls (fire covers) were continuously used, especially types with a broadened or thickened edge (Lusuardi Siena, Negri, Villa 2004, Figs. 7: 11; 12: 1-7). New was the appearance of kettles with an overreaching triangular handle with a hole, which were common in 9<sup>th</sup> and 10<sup>th</sup> century north Italian contexts (Bierbrauer 1986, Pl. 124:10; Lusuardi Siena, Negri, Villa 2004, Figs. 4: 1, 13: 1-2; Pleterski 2008, Figs. 1.4: 3; 4.92), and one was also discovered at Tonovcov grad (Pl. 106: 11). Plates were also relatively common. They appeared already in the 6<sup>th</sup> century, however they continued into the Early Medieval contexts (Lusuardi Siena, Negri, Villa 2004, Fig. 7: 13). Two were also discovered at Tonovcov grad (Pls. 85: 6; 105: 8).

Amongst the decorative techniques in Friuli the often irregular single wavy line with a small amplitude was the most common, while in the Slav sites in eastern and central Slovenia the multiple wavy lines tended to

večlinijska valovnica. Pogosto je tudi grobo metličenje (brazdanje) cele površine posode, ki ga najdemo tako na vzhodnem delu obravnavanega območja (Ciglenečki 2000, t. 20: 2, z zbranimi primerjavami) kot v Furlaniji (Lusuardi Siena, Negri, Villa 2004, sl. 15: 1), pogosto pa poteka v več smereh (Lusuardi Siena, Negri, Villa 2004, sl. 15: 2–3). Na Tonovcovem gradu nepravilno izvedena valovnica ni pogosta, pojavlja se že v plasteh druge poznoantične faze, pa tudi v zgodnj srednjeveških plasteh (glej pogl. 4.2.3).

Izginotje nekaterih starih oblik posod ter pojav novih je verjetno povezano tudi s spremembo načina prehranjevanja po prekinitvi stikov s sredozemskim prostorom.

Prikazane značilnosti keramičnega inventarja na obravnavanem območju kažejo, da bi bilo v prihodnosti potrebno več pozornosti posvetiti kontekstom, iz katerih izvirajo najdbe, ter notranjem razvoju na posameznem najdišču. Analiza grobe keramike s Tonovcovega gradu je pokazala, da je znotraj najdišča vsaj v grobem mogoče slediti razvoju oblik, tehnologije in ornamenta. Primerjava z drugimi najdišči pa je pokazala, da razlike (in podobnosti) v grobi keramiki med posameznimi najdišči nimajo nujno vedno kronološkega vzroka, ampak pogosto pomenijo tudi regionalno značilnost. Za določanje, katere lastnosti so kronološki, katere pa prostorski pokazatelj, pa je nujno poznavanje celotnega keramičnega gradiva posameznih najdišč ter stratigrafskih kontekstov najdb. Uvožena keramika pri današnjem stanju raziskav že nudi dokaj dobro oporo pri ožjih časovnih opredelitvah, z njeno pomočjo pa je možno slediti tudi razvoju oblik in ornamenta pri grobi keramiki.

#### 4.4 LITERATURA / BIBLIOGRAPHY

Tonovcov grad. Naselbinski ostanki in interpretacija / Tonovcov grad. Settlement remains and interpretation = Ciglenečki, Modrijan, Milavec 2011.

ABADIE-REYNAL, C. 1989, *Ceramique et commerce dans le bassin Égéen du IV-e au VII-e siècle. – Hommes et richesses dans l'Empire Byzantin*, vol. 1, Paris 1989.

ANSELMINO, L. in / and C. PAVOLINI 1981, *Terra sigillata*: Lucerne. – V / In: *Atlante I*, 184–207.

ARTHUR, P. 1985, *Appunti sulla ceramica invetriata tardo-romana e alto medievale. Atti del convegno* – Como 14 marzo 1981, 64–66.

ARTHUR, P. 1990, *Anfore dall'alto Adriatico e il problema del Samos Cistern Type*. – *Aquileia Nostra* 61, 282–295.

be more popular. Brush strokes that cover the entire surface, often in various directions, were also common. They were found in the eastern part of the discussed area (Ciglenečki 2000, Pl. 20: 2, with the collected comparisons) and Friuli (Lusuardi Siena, Negri, Villa 2004, Fig. 15: 1). On Tonovcov grad the irregular wavy line was not common, however it appeared in Late Antiquity 2 and Early Medieval layers (see chapter 4.2.3).

The disappearance of certain old shapes and the appearance of new ones was most likely linked to the change in the diet once the contacts with the Mediterranean were broken.

The characteristics of the pottery inventory in the discussed area shows that more attention should be paid to the contexts from which the finds originate and to the development within an individual site. The analysis of coarse ware on Tonovcov grad has shown that the development of the shapes, technology and decoration within the site can be followed to a certain extent. The comparison with other sites has shown that differences (and similarities) in the coarse ware do not necessarily have a chronological cause, however they often represent a regional characteristic. In order to define which characteristics are chronological, and which spatial indices, one has to be acquainted with the entire pottery assemblage from individual sites as well as the stratigraphic contexts of these finds. In the current research imported pottery offers relatively good support when trying to define the time of origin and with its help it is possible to follow the development of coarse ware shapes and decorations.

ARTHUR, P. 1998, *Eastern Mediterranean amphorae between 500 and 700: a view from Italy*. – V / In: *Ceramica in Italia* 1998, 157–184.

ARTHUR, P. in / and D. WILLIAMS, “Pannonische glasierte Keramik”: an assesment. – *Roman Pottery Research in Britain and North-West Europe*. BAR. International Series 123/1, 2, 481–510.

ATLANTE I 1981: *Atlante delle forme ceramiche I; Ceramica fine romana nel bacino mediterraneo (medio e tardo impero)*. – Enciclopedia dell'arte antica, classica e orientale, Roma.

AQUILEIA 1991: Verzár Bass, M. (ur. / ed), *Scavi ad Aquileia I. L'area a est del foro. Rapporto degli scavi* 1988. – Studi e ricerche sulla Gallia Cisalpina 3, Roma.

AQUILEIA 1994: Verzár Bass, M. (ur. / ed), *Scavi ad Aquileia I. L'area a est del foro. Rapporto degli scavi* 1989–1991. – Studi e ricerche sulla Gallia Cisalpina 6, Roma.

AURIEMMA, R. 2007, Produzioni orientali: – V / In: Morselli 2007, 136–154.

AURIEMMA, R. in / and E. QUIRI 2007, La circolazione delle anfore in Adriatico tra V e VII sec. d.C. – V / In: S. Gelichi, C. Negrelli (ur. / ed.), *La circolazione delle ceramiche nell'Adriatico tra tarda antichità e altomedioevo*. Documenti di archaeologia 43, 31–64.

BAUSOVAC, M. 2010, Late Roman amphorae from Rifnik near Celje (Slovenia). – V / In: LRCW3/2, 695–701.

BELAK, M., A. PLETERSKI in / and T. KNIFIC 2008, Katalog predmetov / Katalog der Gegenstände. – V / In: A. Pleterski, *Zgodnjesrednjeveška naselbina na blejski Pristavi. Najdbe. / Frühmittelalterliche Siedlung Pristava in Bled. Funde*. Opera Instituti Archaeologici Sloveniae 14, 171–227.

BERMOND MONTANARI, G. (ur. / ed.) 1983, *Ravenna e il porto di Classe*. – Fonti e studii 7, Bologna.

BERNAL-CASASOLA, D. 2010, Iglesia, producción e comercio en el Mediterráneo tardoantiguo. De las ánforas a los talleres eclesiásticos. – V / In: LRCW3/1, 19–31.

BERTACCHI, L. 1976, La ceramica invetriata di Carlino. – *Aquileia Nostra* 47, 181–194.

BERTI, F. 1983, *Lucerne*. – V / In: Bermond Montanari 1983, 147–154.

BIERBRAUER, V. 1987, *Invillino – Ibligo in Friaul 1. Die römische Siedlung und das spätantik-frühmittelalterliche Castrum*. – Münchner Beiträge zur Vor- und Frühgeschichte 33.

BOLTA, A. 1981, *Rifnik pri Šentjurju. Poznoantična naselbina in grobišče*. – Katalogi in monografije 19.

BOLTIN-TOME, E. 1993, Poskus kronološke opredelitve antičnega naselja v Predloki. – *Annales* 3, 73–84.

BONIFAY, M. (ur. / ed.) 1998, *Fouilles à Marseille: les mobiliers (Ier – VIIe siècles ap. J.-C.)*. Etudes massaliètes 5.

BONIFAY, M. 2004, *Etudes sur le céramique romaine tardive d'Afrique*. – BAR. International Series 1301.

BONIFAY, M. in / and D. PIÉRI 1995, Amphores du Ve au VIIe s. à Marseille: nouvelles données sur la typologie et le contenu. – *Journal of Roman Archaeology* 8, 94–120.

BÓNIS, É. 1991, Glasierte Keramik der Spät Römerzeit aus Tokod. – *Acta Archaeologica Academiae Scientiarum Hungaricae* 43, 87–149.

BORZACONI, A. 2007, La necropoli di San Pietro: un contributo alla storia del popolamento delle Valli del Natisono in età altomedievale / Grobišče v Špietru: Prispevek k poselitveni zgodovini Nadiških dolin v zgodnjem srednjem veku. – V / In: S. Magnani, A. Pesina (ur. / eds.), *Terre d'incontro. Contatti e scambi lungo le Valli di Natisono e dell'Isonzo dall'antichità al medioevo / Kraji srečanj. Stiki in izmenjave vzdol Nadiških in Soške doline od antike do srednjega veka*, Udine - Videm, 250–295.

BROGIOLO, G. P. in / and S. GELICHI 1992, La ceramica invetriata tardo-antica e medievale nel nord Italia. – V / In: *La ceramica invetriata tardoantica e altomedievale in Italia*. Atti del Seminario Certosa di Pontignano (Siena, 23-24 febbraio 1990), 23–32.

BUORA, M. 1990, Viabilità e insediamenti nell'antico Friuli. Un problema di continuità. – V / In: G. Rosada (ur. / ed.), *La Venetia nell'area padano-danubiana. La vie de comunicazione*. Atti del Congresso Internazionale, 41–58.

BUORA, M. in / and G. CASSANI 2002, Osservazioni sulla ceramica grezza del Friuli. Il caso delle terrine. – V / In: R. Curina, C. Negrelli (ur. / eds.), *Primo incontro di studio sulle ceramiche tardo antiche e alto medievali*. Documenti di archeologia 27, 55–63.

BUORA, M. in / and M. FASANO 1994, Udine romana – altomedievale e la grezza terracotta del castello di Udine. – *Arheološki vestnik* 45, 175–185.

BURRAGATO F., M. DI NEZZA, A. F. FERRAZZIOLI in / and M. RICCI 2007, Late Roman I amphora types produced at *Elaiussa Sebaste*. – V / In: LRCW2/2, 689–700.

CAPELLI, C. 1998, Analisi minero-petrografiche. – V / In: L. Saguì, Il deposito della Crypta Balbi: una testimonianza imprevedibile sulla Roma del VII secolo, *Ceramica in Italia* 1998, 331–333.

CAPELLI, C., R. CABELLA in / and M. PIAZZA 2009, Late Roman glazed pottery production in Eastern Alpine area and Danubian provinces: the archaeometric analyses on fabric and glaze. – V / In: C. Magrini, F. Sbarra 2009, 71–82.

CARANDINI, A. 1981, Ceramica africana. Introduzione. – V / In: Atlante I, 11–18.

CARANDINI, A. in / and S. TORTORELLA 1981, Produzione D. – V / In: Atlante I, 78–116.

CASTAGNA, D. in / and S. SPAGNOL 1996, La ceramica grezza dallo scavo dell'Edificio II di Oderzo: una proposta tipologica. – V / In: G. P. Brogiolo, S. Gelichi (ur. / eds.), *Le ceramiche altomedievali (fine VI-X secolo) in Italia settentrionale: produzione e commerci*. Documenti di archeologia 7, 81–93.

CERAMICA IN ITALIA 1998: L. Saguì (ur. / ed.), *Ceramica in Italia: VI - VII secolo. Atti del Convegno in onore di John W. Hayes* (Roma, 11-13 maggio 1995). – Firenze.

CHINELLI, R. 1994a, Ceramica depurata di impasto africano (CCda). – V / In: *Aquileia* 1994, 297–327.

CHINELLI, R. 1994b, Ceramica depurata (CCd). – V / In: *Aquileia* 1994, 238–289.

CIGLENEČKI, S. 1981, Rezultati prvih raziskovanj na Gradcu pri Prapretnem. – *Arheološki vestnik* 31, 417–453.

CIGLENEČKI, S. 1984, Die Keramik des 4.-6. Jahrhunderts von Gradec, Tinje und Korinjski hrib, Slowenien. – *Archeologia Austriaca* 68, 313–328.

- CIGLENEČKI, S. 1985, Potek alternativne ceste Siscia-Aquileia na prostoru zahodne Dolenjske in Notranjske v času 4. do 6. stol. Preliminarno poročilo o raziskovanjih Korinjskega hriba in rekognosciranjih zahodne Dolenjske. – *Arheološki vestnik* 36, 255–284.
- CIGLENEČKI, S. 1994a, Poznoantična naselbina Tonovcov grad pri Kobaridu. – *Kronika* 42, 1–14.
- CIGLENEČKI, S. 1994b, Scavi nell'abitato tardoantico di Tonovcov grad presso Caporetto (Kobarid) Slovenia. Rapporto preliminare. – *Aquileia Nostra* 65, 185–208.
- CIGLENEČKI, S. 1995, Zgodnjekrščanski stavbni kompleks / Frühchristlicher Gebäudekomplex. – V / In: J. Dular, Ciglenečki, A. Dular 1995, 71–190.
- CIGLENEČKI, S. 2000, *Tinje nad Loko pri Žusmu / Tinje oberhalb von Loka pri Žusmu*. – Opera Instituti Archaeologici Sloveniae 4.
- CIGLENEČKI, S., Z. MODRIJAN in / and T. MILAVEC 2011, *Poznoantična naselbina Tonovcov grad pri Kobaridu. Naselbinske najdbe in interpretacija / Late Antique fortified settlement Tonovcov grad near Kobarid. Settlement remains and interpretation*. – Opera Instituti Archaeologici 23.
- CIVIDINI, T. 1994, Terra sigillata africana (CA). – V / In: *Aquileia* 1994, 126–192.
- CORTESE, C. 2005, Le ceramiche comuni: problemi generale e criteri di classificazione. – V / In: L. Gandolfi (ur. / ed.), *La ceramica e in materiali di eta romana. Classi, produzioni, commerci e consumi*. Quaderni della Scuola Interdisciplinare delle Metodologie Archeologiche 2, 325–338.
- COVIZZI, C. 1995, *La morfologia*. – V / In: Santoro Bianchi 1995, 33–75.
- CUNJA, R. 1996, *Poznorimski in zgodnjekrščanski Koper. Arheološko izkopavanje na bivšem Kapucinskem vrtu v luči drobnih najdb 5. do 9. stoletja / Capodistria Tardoromana e Altomedievale. Lo scavo archeologico nell'ex Orto dei cappuccini negli anni 1986–1987 alla luce dei reperti dal V al IX secolo d. C.* – Koper.
- CUOMO DI CAPRIO, N. 1985, *La ceramica in archeologia. Antiche tecniche di lavorazione e moderni metodi di indagine*. – Roma.
- CUOMO DI CAPRIO, N. 2007, *Ceramica in archeologia 2. Antiche tecniche di lavorazione e moderni metodi di indagine*. – Roma.
- CURTA, F. 2001, Peasants as “Makeshift Soldiers for the Occasion”: Sixth-Century Settlement Patterns in the Balkans. – V / In: T. S. Burns, J. W. Eadie (ur. / eds.), *Urban Centres and Rural Contexts in Late Antiquity*, East Lansing (Michigan).
- CVJETIČANIN, T. 1994, Late Roman glazed pottery from the Iron Gate region (*Dacia Ripensis*). – *Acta Rei Creariae Romanae Fautorum* 34 (Alba Regia 25), 27–31.
- CVJETIČANIN, T. 1997, Late Roman glazed pottery as a military commodity. – *Acta Rei Creariae Romanae Fautorum* 35, 17–25.
- CVJETIČANIN, T. 2001, *Gledžosana keramika gornje Mezije / Glazed pottery from Upper Moesia*. – Arheološke monografije 12, Beograd.
- CVJETIČANIN, T. 2006, *Kasnoantička gledžosana keramika: gledžosana keramika Prve Mezije, Priobalne Dakije, Sredozemne Dakije i Dardanije*. – Arheološke monografije 19, Beograd.
- DASZKIEWICZ, M. in / and G. SCHNEIDER 1999, Chemical, mineralogical and technological studies of fabrics of Roman vessels and lamps from Poetovio. – V / In: Istenič 1999, 173–190.
- DASZKIEWICZ, M. in / and G. SCHNEIDER 2001, Klassifizierung von Keramik durch Nachbrennen von Scherben. – *Zeitschrift für Schweizerische Archeologie und Kunstgeschichte* 58, 25–32.
- DEGRASSI, V., D. GADDI in / and L. MANDRUZZATO 2007, Amphorae and coarse ware from Late Roman – Early medieval layers of the recent excavations in Tergeste/Trieste (Italy). – V / In: LRCW2/2, 503–510.
- DELLA PORTA, C., N. SFREDDA in / and G. TASSINARI 1998, *Ceramiche comuni*. – V / In: G. Olcese (ur. / ed.) 1998, 133–299.
- DULAR, J., S. CIGLENEČKI in / and A. DULAR 2005, *Kučar. Železnodobno naselje in zgodnjekrščanski stavbni kompleks na Kučarju pri Podzemlju / Kučar. Eisenzeitliche Siedlung und frühchristlicher Gebäudekomplex auf dem Kučar bei Podzemelj*. – Opera Instituti Archaeologici Sloveniae 1.
- DONAT, P. 1994a, Anfore africane. – V / In: *Aquileia* 1994, 413–450.
- DONAT, P. 1994b, Anfore dal Mediterraneo orientale. – V / In: *Aquileia* 1994, 398–413.
- EBNER, D. 1997, Die spätrömische Töpferei und Ziegelei von Friedberg-Stätzling, Lkr. Aichach-Friedberg. – *Bayerische Vorgeschichtsblätter* 62, 115–219.
- EIRING, J. in / and J. LUND (ur. / eds.) 2004, *Transport Amphorae and Trade in the Eastern Mediterranean*. Actes of the International Colloquium at the Danish Institute at Athens, September 26–29, 2002. Monographs of Danish Institute at Athens 5, 293–308, Aarhus.
- ELTON, H. 2005, The economy of southern Asia Minor and LR 1 Amphorae. – V / In: LRCW1, 2005, 691–695.
- EMPEREUR, J. Y. in / and M. PICON 1989, Les régions de production d'amphores impériales en Méditerranée orientale. – V / In: *Amphores Romaines et histoire économique: dix ans de recherche. Actes du colloque de Sienne (22-24 mai 1986)*. Coll. de l'École française de Rome 114, 223–248.
- ETTLINGER, E. 1977, Die Kleinfunde aus dem spätrömischen Kastell Schaan, Keramik. – V / In: Kleine Schriften. *Acta Rei Creariae Romanae Fautorum, Supplementa Vol. 2*, 94–134.
- FAILLA, A. 1995, *Analisi archeometriche su campioni di ceramiche grezze di Castelraimondo*. – V / In: Santoro Bianchi 1995, 95–118.

FELGENHAUER-SCHMIEDT, S. 1993, *Das Kappele ("die Kåpile") ob Jadersdorf. Eine spätantik-frühmittelalterliche Höhensiedlung in Oberkärnten*. – Aus Forschung und Kunst 27.

FONTANA, S. 1998, Le "imitazioni" della sigillata africana e le ceramiche da mensa italiche tardo antiche. – V / In: *Ceramica in Italia* 1998, 83–100.

FREED, J. 1995, The late series of Tunisian cylindrical amphoras at Carthage. – *Journal of Roman Archaeology* 8, 155–191.

FRIESINGER, H. in / and H. KERCHLER 1981, Töpferöfen der Völkerwanderungszeit in Niederösterreich. Ein Beitrag zur völkerwanderungszeitlichen Keramik (2. Hälfte 4.–6. Jahrhundert n. Chr.) in Niederösterreich und dem Burgenland. – *Archaeologia Austriaca* 65, 193–269.

FULFORD M. G. in / and D. P. S. PEACOCK 1984, *Excavations at Carthage: The British Mission Vol. I, 2. The Avenue du President Habib Burgiba, Salambo. The pottery and other ceramic objects from the site*. – Sheffield.

FULFORD M. G. in / and D. P. S. PEACOCK 1994, *Excavations at Carthage: The British Mission Vol. II, 2. The Circular Harbour, North Side. The pottery*. – Oxford.

GANDOLFI, D. 1997–1998, Sigillata focese in Liguria. – V / In: D. Gandolfi (ur. / ed.), *Nel ricordo di Nino Lamboglia*, Rivista di Studi Liguri 63–64, 421–442.

GASPARI, A., V. VIDRIH PERKO, M. ŠTRAJHAR in / and I. LAZAR 2007, Antični pristaniški kompleks v Fizinah pri Portorožu – zaščitne raziskave leta 1998 / The Roman port complex at Fazine near Portorož – rescue excavations in 1998. – *Arheološki vestnik* 58, 167–218.

GHALIA, T., M. BONIFAY in / and C. CAPELLI 2005, L'atelier de Sidi-Zahrani: mise en évidence d'une production d'amphores de l'Antiquité Tardive sur le territoire de la cité de *Neapolis* (Nabeul, Tunisie). – V / In: LRCW1, 495–507.

GIESLER, U. 1981, Die Kleinfunde. – V / In: Ulbert 1981, 53–147.

GUŠTIN, M. 2002 (ur. / ed.), *Zgodnji Slovani. Zgodnjerednjeveška lončenina na obrobju vzhodnih Alp / Die frühen Slaven. Frühmittelalterliche Keramik am Rand der Ostalpen*. – Ljubljana.

GUŠTIN, M. in / and G. TIFENGRABER 2002, Oblike in kronologija zgodnjerednjeveške lončenine na Novi tabli pri Murski Soboti / Formen und Chronologie frühmittelalterlicher Keramik in Nova tabla bei Murska Sobota. – V / In: Guštin 2002, 46–62.

HAYES, J. W. 1972, *Late Roman Pottery*. – London.

HAYES, J. W. 1980, *Supplement to Late Roman Pottery*. – London.

HORVAT, J. 1990, *Nauportus (Vrhniko)*. – Dela 1. razreda SAZU 33.

HORVAT, M. 1999, *KerAMIKA. Tehnologija keramike, tipologija lončnine, keramični arhiv*. – Razprave Filozofske fakultete, Ljubljana.

ISTENIČ, J. 1999, *Poetovio, Zahodna grobišča I. Grobne celote iz deželnega muzeja Joanneuma v Gradcu. / Poetovio, the Western Cemeteries I. Grave-groups in the Landesmuseum Joanneum, Graz*. – Katalogi in monografije 32.

ISTENIČ, J. in / and G. SCHNEIDER 2000, Aegean cooking ware in the eastern Adriatic. – *Acta Rei Cretariae Romanae Fautorum* 36, 341–348.

KAJFEŽ, T. in / and D. JOSIPOVIČ 2000, Prispevek k poznavanju poznorimske in zgodnjerednjeveške uvožene keramike koprškega otoka. – *Annales: anali za istrske in mediteranske študije, Series historia et sociologia* 10/1, 51–62.

KARAGIORGOU, O. 2001, LR2: a Container for the Military annona on the Danubian Border? – V / In: S. Kingsley, M. Decker (ur. / eds.), *Economy and Exchange in the East Mediterranean during Late Antiquity*, 129–166, Oxford.

KEAY, S. J. 1984, *Late Roman Amphorae in the Western Mediterranean. A typology and economic study: the Catalan evidence*. – BAR. International Series 196/1, 2.

KEAY, S. 1998, African amphorae. – V / In: *Ceramica in Italia* 1998, 141–155.

KERMAN, B. 2002, Staroslovanska naselbina Kotare - baza pri Murski Soboti / Die altslawische Siedlung Kotare – baza bei Murska Sobota. – V / In: Guštin 2002, 17–26.

KNIFIC, T. 1979, Vranje pri Sevnici. Drobne najdbe z Ajdovskega gradca (leto 1974). – *Arheološki vestnik* 30, 732–785.

KNIFIC, T. 1994, Vranje near Sevnica: A Late Roman Settlement in the light of Certain Pottery Finds. – *Arheološki vestnik* 45, 211–237.

KNIFIC, T. 2002, Lončenina v zgodnjerednjeveških grobovih v Sloveniji. / Die Keramik in den frühmittelalterlichen Gräbern in Slowenien – V / In: Guštin 2002, 115–129.

KOROŠEC, J. 1956, *Arheološke ostaline v Predjambi*. – Razprave 1. razreda SAZU 4/1.

KOROŠEC, P. in / and J. KOROŠEC jr. 1978, Arheološke raziskave na Svetih gorah ob Sotli v letu 1974. – *Arheološki vestnik* 29, 432–436.

LADSTÄTTER, S. 2000, *Die materielle Kultur der Spätantike in den Ostalpen. Eine Fallstudie am Beispiel der westlichen Doppelkirchenanlage auf Hemmaberg*. – Mitteilungen der Prähistorischen Kommission 35.

LADSTÄTTER, S. 2003, Zur Charakterisierung des spätantiken Keramikspektrums im Ostalpenraum – V / In: *Frühe Kirchen im östlichen Alpengebiet. Von der Spätantike bis in ottonische Zeit*. Bayerische Akad. der Wiss., Phil.-Hist. Klasse, N.F., 123/2, 831–857.

LADSTÄTTER, S. in / and R. SAUER 2000, Scherbentypen. – V / In: Ladstätter 2000, 85–90.

LAMBOGLIA, N. 1958, Nuove osservazioni sulla "terra sigillata chiara" (Tipi A e B). – *Rivista di Studi Liguri* 24, 257–330.

LAMBOGLIA, N. 1963, Nuove osservazioni sulla "terra sigillata chiara" 2 (la terra sigillata chiara C). – *Rivista di Studi Liguri* 29, 145–212.

LAUBENHEIMER, F. 1990, *Le temps des amphores en Gaule. Vins, huiles et sauces*. – Paris.

LEBEN, F. in / and Z. ŠUBIC 1990, Poznoantični kastel Vrh Brsta pri Martinj Hribu na Logaški planoti. – *Arheološki vestnik* 41, 313–354.

LRCW1 2005: J. M. Gurt Esparraguera, J. Buxeda i Garrigós, M. A. Cau Ontiveros (ur. / eds.), *LRCW1. Late Roman Coarse Wares, Cooking Wares and Amphorae in the Mediterranean: Archaeology and Archaeometry* 1. – BAR. International Series 1340.

LRCW2 2007: M. Bonifay in / and J.-C. Tréglia (ur. / eds.), *LRCW2. Late Roman Coarse Wares, Cooking Wares and Amphorae in the Mediterranean: Archaeology and Archaeometry* 2. – BAR. International Series 1662 (1,2).

LRCW3 2010, S. Menchelli, S. Santoro, M. Pasquinnucci in / and G. Guiducci (ur. / eds.), *LRCW3. Late Roman Coarse Wares, Cooking Wares and Amphorae in the Mediterranean: Archaeology and archeometry. Comparison between western and eastern Mediterranean* 3. – BAR. International Series 2185 (1,2).

LUSUARDI SIENA, S. in / and A. NEGRI 2007, A proposito del vasellame friuliano con marchio sul fondo tra tarda antichità e medioevo. – V / In: S. Gelichi, C. Negrelli (ur. / eds.), *La circolazione delle ceramiche nell'Adriatico tra tarda antichità e altomedioevo*. Documenti di archaeologia 43, 183–214.

LUSUARDI SIENA, S. in / and M. SANNAZARO 1985, Ceramica invetriata di Castelseprio. – V / In: *La ceramica invetriata tardoromana e alto medioevale. Atti del convegno, Como 14 marzo 1981*, 31–47.

LUSUARDI SIENA, S. in / and M. SANNAZARO 1992, Castelseprio (VA). – V / In: *La ceramica invetriata tardoantica e altomedievale in Italia. Atti del Seminario Certosa di Pontignano (Siena, 23-24 febbraio 1990)*, 195–199.

LUSUARDI SIENA, S., A. NEGRI in / and L. VILLA 2004, La ceramica altomedievale tra Lombardia e Friuli. Bilancio delle conoscenze e prospettive di ricerca (VIII-IX e X-XI secolo). – V / In: S. P. Uggeri, *La ceramica altomedievale in Italia*. Quaderni di archeologia medievale 6, 59–102.

MACCABRUNI, C. 1990, Ceramica invetriata. – V / In: *Milano capitale dell'impero romano 286-402 d.C.*, 367–371.

MACKENSEN, M. 1983, Ein Nachtrag zu den Kleinfunden vom Moosberg bei Murnau. – *Bayerische Vorgeschichtsblätter* 48, 195–206.

MACKENSEN, M. 1987, Mediterrane Sigillata, Lampen und Amphoren. – V / In: Bierbrauer 1987, 229–265.

MACKENSEN, M. 1992, Amphoren und Spatheia von Golemanovo Kale. – V / In: S. Uenze, *Die spätantike*

*Befestigungen von Sadovec (Bulgarien)*, Münchner Beiträge zur Vor- und Frühgeschichte 43, 239–254.

MACKENSEN, M. 1993, *Die spätantiken Sigillata- und Lampentöpfereien von El Mahrine (Nordtunesien)*. – Münchner Beiträge zur Vor- und Frühgeschichte 50/1,2.

MAGRINI, C. in / and F. SBARRA 2005, *Le ceramiche invetriate di Carlino. Nuovo contributo allo studio di una produzione tardo antica*. – *Ricerche di archeologia altomedievale e medioevale* 30, Firenze.

MAGRINI, C. in / and F. SBARRA 2009, *La ceramica invetriata tardoromana nell'arco Alpino orientale e nelle province Danubiane. Primi risultati di un progetto internazionale. / Late Roman glazed pottery productions in eastern Alpine area and Danubian provinces. First results of an international project*. – Carlino.

MAIOLI, M. G. 1983, La ceramica invetriata. – V / In: J. Bermond Montanari, 1983, 113–117.

MALAGUTI, C., P. RIAVEZ, M. ASOLATI, M. BRESSAN, A. MARCANTE in / and S. MASSA 2007, Grado. Cultura materiale e rotte commerciali nell'Adriatico tra Tardoantico e Altomedioevo. – V / In: S. Gelichi, C. Negrelli (ur. / ed.), *La circolazione delle ceramiche nell'Adriatico tra tarda antichità e altomedioevo*. Documenti di archaeologia 43, 65–90.

MANACORDA, D. 1977, Le anfore. V / In: Ostia 4, 117–285.

MANDRUZZATO, L., C. TIUSSI in / and V. DEGRASSI 2000, Appunti sull'instrumentum d'importazione Greca ed orientale ad Aquileia. – *Acta Rei Cretariae Romanae Fautorum* 36, 359–364.

MARTELLI, A. 1995, *La decorazione*. – V / In: Santoro Bianchi 1995, 119–132.

MARTIN, A. 1998, La sigillata focese (Phocaeen Red-Slip/Late Roman C Ware). – V / In: Ceramica in Italia 1998, 109–139.

MASELLI SCOTI, F. (ur. / ed.) 1989, *Longobardi a Romans d'Isonzo. Itinerario attraverso le tombe altomedievali*. – Udine.

MASELLI SCOTTI F., V. DEGRASSI, L. MANDRUZZATO, G. MIAN, V. PROVENZALE, D. RICOBONO in / and C. TIUSSI 2004, *La Domus di Piazza Barbacan (Trieste): le fasi e i materiali*. – *Atti e memorie della Società Istriana di Archeologia e Storia Patria* 104/1, ns. 52/1, 19–158.

MASON, P. 1998, Late Roman Črnomelj and Bela Krajina. – *Arheološki vestnik* 49, 285–313.

MASSA, S. in / and B. PORTULANO 1999, La ceramica comune. – V / In: G. P. Brogiolo (ur. / ed.), *S. Giulia di Brescia. Gli scavi dal 1980 al 1992. Reperti preromani, romani e altomedievali*, 143–173.

METERC, J. 1981, Slučajne najdbe z Ajdne. – *Arheološki vestnik* 32, 405–416.

MIKL CURK, I. 1973, Zapažanja o temni rimski kuhinjski lončeni posodi v Sloveniji. – *Arheološki vestnik* 24, 883–900.



- MIKL-CURK, I. 1983, Določitev keramike / The Definition of Pottery. – V / In: Plesničar-Gec L., *Starokrščanski center v Emoni / Old Christian Center in Emona*. Katalog in monografije 21, 66–70.
- MILAVEC, T. in / and Z. MODRIJAN 2007, L'insediamento tardoantico di Tonovcov grad alla luce dei reperti ceramici e metallici. / Poznoantična naselbina Tonovcov grad v luči kovinskih in keramičnih najdb. – V / In: S. Magnani, A. Pesina (ur. / ed.), *Terre d'incontro. Contatti e scambi lungo le Valli di Natisone e dell'Isonzo dall'antichità al medioevo. / Kraji srečanj. Stiki in izmenjave vzdol Nadižkih in Soške doline od antike do srednjega veka*, Udine – Videm, 106–127.
- MIRNIK-PREZELJ, I. 1984, *Ajdovski gradec nad Vranjem pri Sevnici. Arheološka izkopavanja 1980–1982*. – Diplomatska naloga / Undergraduate thesis, Oddelek za arheologijo, Filozofska fakulteta Univerze v Ljubljani, Ljubljana.
- MLINAR, M. 2002, Zgodnjesrednjeveški posodi z Mosta na Soči, ledina Repelc / Zwei frühmittelalterliche Gefäße aus Most na Soči, Flur Repelc. – V / In: Guštin 2002, 111–112.
- MODRIJAN, Z. 2009, Glazed pottery from Korinjski hrib and Tonovcov grad (Slovenija). – V / In: C. Magrini, F. Sbarra 2009, 33–40.
- MODRIJAN, Z. 2010, The last phases of the settlement at Tonovcov grad (Slovenia): the ceramic evidence. – V / In: LRCW3/2, 689–694.
- MODRIJAN, Z. 2011, Continuity in Late Antiquity Slovenian fortified hilltop settlements. – V / In: O. Heinrich-Tamáska (ur. / ed.), *Keszthely-Fenekpuszta im Kontext spätantiker Kontinuitätsforschung zwischen Noricum und Moesia*, 157–171, Budapest, Leipzig, Keszthely, Rahden (Westf.).
- MORSELLI, C. (ur. / ed.) 2007, *Trieste antica. Lo scavo di Crosada. I materiali*. – Fonti e studi per la storia della Venezia Giulia, Trieste.
- MUNSELL 2000, *Munsell soil color charts*. – New York.
- MURIALDO, G. 2007, Alto-Adriatico e alto-Tirreno nel mondo mediterraneo: due mari a confronto tra VI e X secolo. – *La circolazione delle ceramiche nell'Adriatico tra tarda antichità e alto medioevo*. Documenti di archeologia 43, 9–29.
- MURIALDO, G., G. OLCESE, P. PALAZZI in / and L. PAROLI 1998, La ceramica comune in Liguria nel VI e VII secolo. – V / In: *Ceramica in Italia 1998*, 227–251.
- OLCESE, G. 1998, *Ceramiche in Lombardia tra II secolo a.C e VII secolo d.C.: raccolta degli dati editi*. – Documenti di archeologia 16.
- OPAIȚ, A. 2004a, The Eastern Mediterranean Amphorae in the Province of Scythia: – V / In: J. Eiring, J. Lund 2004, 293–308.
- OPAIȚ, A. 2004b, Local and Imported Ceramics in the Roman Provinces of Scythia (4<sup>th</sup> – 6<sup>th</sup> centuries AD). – BAR. International Series 1274, Oxford.
- OPAIȚ, A. 2010, On the origin of the Carthage LR amphora 1. – V / In: LRCW3/2, 1015–1022.
- ORTON, C. 1980, *Mathematics in Archaeology*. – Cambridge.
- ORTON, C., P. TYERS in / and A. VINCE 1993, *Pottery in archaeology*. – Cambridge manuals in archaeology, Cambridge.
- OSMUK, N. 1987, Die Bronzeplastik aus Kobarid. – *Archaeologia Jugoslavica* 24, 57–79.
- OSMUK, N. 1997, Kobarid od prazgodovine do antike. – V / In: *Kobarid*. Kobarid, 9–16.
- OSTIA 1, 1968, *Le Terme del Nuotatore. Scavo dell'ambiente IV*. – Studi miscellanei 13, Roma.
- OSTIA 2, 1970, *Le Terme del Nuotatore. Scavo dell'ambiente I*. – Studi miscellanei 16, Roma.
- OSTIA 3, 1973, *Le Terme del Nuotatore. Scavo dell'ambiente V e di un saggio nell'area SO*. – Studi miscellanei 21, Roma.
- OSTIA 4, 1977, *Le Terme del Nuotatore. Scavo dell'ambiente XVI e dell'area XXV*. – Studi miscellanei 23.
- PAHIČ, S. 1978, Najdbe z rimske ceste Slovenska Bistrica - Pragersko. – *Arheološki vestnik* 29, 129–289.
- PAHIČ, S. 1980, Prvi podatki o grobi hišni lončeni z Brinjeve gore. – *Arheološki vestnik* 31, 388–438.
- PANELLA, C. 1973, Anfore. – V / In: *Ostia 3*, 1973, 163–633.
- PANELLA, C. 1993, Merci e scambi nel Mediterraneo tardoantico. – V / In: *Storia di Roma III. L'età tardoantica 2. I luoghi e le culture*, 613–697, Roma.
- PANELLA, C. 2001, Le anfore di età imperiale nel Mediterraneo occidentale. V / In: *Ceramiques hellénistiques et romaines III*, 177–275.
- PATTERSON, H., A. BOUSQUET, S. FONTANA, R. WITCHER in / and S. ZAMPINI 2005, Late Roman common wares and amphorae in the middle Tiber valley, the preliminary results of the Tiber valley project. – V / In: LRCW1, 369–384.
- PATTERSON, H. in / and P. ROBERTS 1998, New light on dark age Sabina. – V / In: *Ceramica in Italia*, 421–435.
- PEACOCK, D. P. S. 1977, Ceramics in Roman and Medieval Archaeology. – V / In: D. P. S. Peacock (ur. / ed.), *Pottery and Early Commerce. Characterization and Trade in Roman and Later Ceramic*, 21–33.
- PEACOCK, D. P. S. 1984, Petrology and origins. – V / In: M. G. Fulford, D. P. S. Peacock 1984.
- PEACOCK, D. P. S., F. BEJAOU in / and N. BELAZREG 1989, Roman Amphora Production in the Sahel Region of Tunisia. – V / In: *Amphores Romaines et histoire économique: dix ans de recherche*. Actes du colloque de Sienna (22–24 mai 1986). Coll. de l'École française de Rome, 179–222.
- PERKO V., A. BAVDEK in / and I. LAZAR 1998, Poznoantično najdišče Šmarata. – *Arheološki vestnik* 49, 271–283.

PERKO, V. in / and L. PLESNIČAR GEC 1991, Einfluss der Terra Sigillata Chiara auf die einheimischen Keramikformen in Emona. – *Acta Rei Cretariae Romanae Fautorum* 29/30, 109–117.

PIERI, D. 2005, *Le Commerce du vin oriental à l'époque Byzantine (V<sup>e</sup>-VII<sup>e</sup> siècles). Le témoignage des amphores en Gaule*. – Beyrouth.

PLETERSKI, A. 2008, *Kuhinjska kultura v zgodnjem srednjem veku*. – Ljubljana.

PLETERSKI, A. in / and M. BELAK 2002, Lončenina z Gradu na Gorenjem Mokronogu in vprašanje prevzema lončarskih znanj / Keramik vom Grad am Gorenji Mokronog und die Frage der Übernahme von Töpfereiwissen. – V / In: Guštin 2002, 98–103.

PRÖTTEL, P. M. 1996, *Mediterrane Feinkeramikimporte des 2. bis 7. Jahrhunderts n. Chr. im oberen Adria-raum und in Slowenien*. – Kölner Studien zur Archäologie der römischen Provinzen 2.

RILEY, J. A. 1976, Late amphoras. – V / In: *Excavations at Carthage 1975 conducted by the University of Michigan*, Vol. I, 125–156.

RILEY, J. A. 1981, The Pottery from the Cisterns 1977.1, 1977.2 and 1977.3 – V / In: *Excavations at Carthage 1979 conducted by the University of Michigan*, Vol. VI, 85–124.

RAVNIK, M. 2006, *Zaščitne raziskave Ančnikovega gradišča pri Jurišni vasi v letih od 1986 do 1994*. – Diplomaska naloga / Undergraduate thesis, Oddelek za arheologijo, Filozofska fakulteta Univerze v Ljubljani, Ljubljana.

REYNOLDS, P. 1993, *Settlement and pottery in the Vinalopó Valley (Alicante, Spain): AD 400-700*. BAR. International Series 588.

REYNOLDS, P. 1995, *Trade in the Western Mediterranean, AD 400-700: The ceramic evidence*. BAR. International Series 604.

REYNOLDS, P. 2005, Levantine amphorae from Cilicia to Gaza: a typology and analysis of regional production trends from 1<sup>st</sup> to 6<sup>th</sup> centuries. – V / In: LRCW1, 563–611.

RODRIGUEZ, H. 1986, *Die vor- und frühgeschichtlichen Kleinfunde vom Lavanter Kirchbichl in Osttirol*. – Neobjavljena doktorska disertacija / Unpublished doctoral thesis, Innsbruck.

RODRIGUEZ, H. 1988, Spätromische und spätantike Keramikfunde von Kathreinkogel. – *Archäologie Alpen Adria* 1, 143–150.

RODRIGUEZ, H. 1990, Keramikbeispiele aus der Grabungskampagne 1989 in Teurnia im Areal der Bischofskirche und ihrer Nebengebäude. – *Carinthia* I 180, 57–107.

RODRIGUEZ, H. 1992, Bemerkungen zur relativ-chronologischen Gliederung der südostalpinen spätromisch-spätantiken Gebrauchskeramik. – V / In: *Il territorio tra tardoantico e altomedioevo. Metodi di indagine e risultati*, 159–178.

RODRIGUEZ, H. 1997, Die Zeit vor und nach der Schlacht am Fluvius Frigidus (394 n. Chr.) im Spiegel der südostalpinen Gebrauchskeramik. – *Arheološki vestnik* 48, 153–177.

RUPEL, L. 1988, Aspetti della ceramica comune romana in Friuli: materiali da Vidulis e Coseano. – *Aquileia Nostra* 59, 105–167.

RUPEL, L. 1994, Ceramica grezza (CCg). – V / In: *Aquileia* 1994, 194–238.

SAGADIN, M. 1995, Mengeš v antiki. – *Arheološki vestnik* 46, 217–245.

SAGADIN, M. 1998, Carniola u svjetlu novih nalaza. – V / In: *Radovi 13. međunarodnog kongresa za starokršćansku arheologiju* 3, Split – Poreč.

SAGADIN, M. 2008, *Od Karnija do Kranja*. – Neobjavljena doktorska disertacija / Unpublished doctoral thesis, Oddelek za arheologijo, Filozofska fakulteta Univerze v Ljubljani, Ljubljana.

SAGUĀ, L. 2002, Roma, i centri privilegiati e la lunga durata della tarda antichità. Dati archeologici dal deposito di VII secolo nell'edera della Crypta Balbi. – *Archeologia Medievale* 29, 7–42.

SANTORO BIANCHI, S. (ur. / ed.) 1995, *Castelraimondo. Scavi 1988-1990. 2 - Informatica, archeometria e studia dei materiali*. – Cataloghi e monografie archeologiche dei Civici musei di Udine 5.

SCHNEIDER, G. (ur. / ed.) 1989, Naturwissenschaftliche Kriterien und Verfahren zur Beschreibung von Keramik. – *Acta Praehistorica et Archaeologica* 21, 7–51.

SLAPŠAK, B. 1985, Ajdovščina nad Rodikom. Prazgodovinsko in antično naselje / Prehistoric and Roman Settlement. – *Arheološki pregled* 26, 135–136.

SNOJ, D. in / and M. NOVŠAK 1992, Piran. – *Varstvo spomenikov* 34, 265–272.

SOKOL, V. 1994, Das spätantike Kastrium auf dem Kuzelin bei Donja Glavnica. – *Arheološki vestnik* 45, 199–209.

STEINKLAUBER, U. 1990, Der Duel und seine Kleinfunde. – *Carinthia* I/180, 109–136.

STONE, D. L. 2009, Supplying Rome and the empire: the distribution of stamped amphoras from Byzacena. – V / In: J. H. Humphrey (ur. / ed.), *Studies on roman pottery of the provinces of Africa Proconsularis and Byzacena (Tunisia). Hommage à Michel Bonifay*, Journal of Roman Archaeology, Supplementary series 76, 127–149.

STOPPIONI PICOLLI, M. L. 1983, Le anfore. – V / In: Bermond Montanari 1983, 130–146.

STRMČNIK, M. 1997, Mariborsko – bistriško območje v poznorimski dobi. – *Arheološki vestnik* 48, 269–288.

STRMČNIK GULIČ, M. 1988, Jurišna vas, Ančnikovo gradišče. – *Varstvo spomenikov* 30, 258–263.

SVOLJŠAK, D. 1985, Sv. Pavel nad Vrtovinom. Rezultati sondiranja leta 1966. – *Arheološki vestnik* 36, 195–236.

SWAN, V. 2004, Dichin (Bulgaria) and the Supply of Amphorae to the Lower Danube in the Late Roman – Early Byzantine Period. – V / In: J. Eiring, J. Lund 2004, 371–382.

TOMBER, R. 1991, Methods for investigating deposit homogeneity. – *Journal of Roman Pottery Studies* 4, 59–68.

TONIOLO, A. 2007, Anfore dall'area lagunare. – V / In: S. Gelichi, C. Negrelli (ur. / eds.), *La circolazione delle ceramiche nell'Adriatico tra tarda antichità e altomedioevo*. Documenti di archaeologia 43, 91–106.

TURK, I., A. BAVDEK, V. PERKO, M. CULIBERG, A. ŠERCELJ, J. DIRJEC in / and P. PAVLIN 1992, Acijev spodmol pri Petrinjah. – *Poročilo o raziskovanju paleolita, neolita in eneolita v Sloveniji* 20, 27–48.

TURK, I., Z. MODRIJAN, T. PRUS, M. CULIBERG, A. ŠERCELJ, V. PERKO, J. DIRJEC in / and P. PAVLIN 1993, Podmol pri Kastelcu – novo večplastno arheološko najdišče na Krasu, Slovenija. – *Arheološki vestnik* 44, 45–96.

TURK, P. 2002, Dragomelj - zgodnjesrednjeveška naselbina / Dragomelj - eine frühmittelalterliche Siedlung. – V / In: Guštin 2002, 79–93.

ULBERT, T. 1981 (ur. / ed.), *Ad Pirum (Hrušica)*. *Spatromische Passbefestigung in den julischen Alpen*. – *Münchner Beiträge zur Vor- und Frühgeschichte* 31.

URLEB, M. 1974, Križna gora. – *Katalogi in monografije* 11.

VAN ALFEN, P. G. 1996, New light on the 7th-c. Yassi Ada shipwreck: capacities and standard sizes of LRA1 amphoras. – *Journal of roman archaeology* 9, 189–213.

VENTURA, P. 1991, Terra sigillata africana (CA). – V / In: Aquileia 1991, 119–138.

VENTURA, P. in / and V. DEGRASSI 2005, Risesame del materiale ceramico dalla villa di Lucinico (Gorizia, Italia). – *Acta Rei Cretariae Romanae Favtorum* 39, 91–101.

VIDRIH PERKO, V. 1992a, Afriška sigilata v Emoni. – *Arheološki vestnik* 43, 93–104.

VIDRIH PERKO, V. 1992b, La ceramica tardoantica di Hrušica (Ad Pirum). – *Acta Rei Cretariae Romanae Favtorum* 31/32, 349–364.

VIDRIH PERKO, V. 1994a, Spätantike keramische Neufunde aus Piran. – *Acta Rei Creariae Romanae Favtorum* 34 (*Alba Regia* 25), 241–248.

VIDRIH PERKO, V. 1994b, *Poznoantične amfore v Sloveniji*. – Neobjavljena doktorska disertacija / Unpublished doctoral thesis. Oddelek za arheologijo, Filozofska fakulteta Univerze v Ljubljani, Ljubljana.

VIDRIH PERKO, V. 1997a, Rimskodobna keramika z Ajdovščine pri Rodiku. – *Arheološki vestnik* 48, 341–358.

VIDRIH PERKO, V. 1997b, Some Late Roman ceramic finds from the Slovenian Karst region. – *Acta Rei Cretariae Romanae Favtorum* 35, 249–258.

VIDRIH PERKO, V. 2000, Amfore v Sloveniji. – *Annales. Ser. hist. sociol.* 10, 421–455.

VIDRIH PERKO, V. in / and M. SAGADIN 2004, Gorenjska v antiki. – *Kamniški zbornik* 17, 207–224.

VIDRIH PERKO, V. in / and B. ŽBONA TRKMAN 2004, Ceramic finds from Ajdovščina-Fluvio Frigido, an Early Roman road station and Late Roman fortress *Castra*. – *Acta Rei Creariae Romanae Favtorum* 39, 277–286.

VIDRIH PERKO, V. in / and M. ŽUPANČIČ 2003, Il popolamento della Slovenia sudoccidentale e dell'Istria settentrionale nel periodo tardoromano e nell'alto medioevo alla luce delle ceramiche di importazione. – *Histria antiqua* 11, 457–476.

VIDRIH PERKO, V. in / and M. ŽUPANČIČ 2005, Amphorae in western Slovenia and in northern Istria. – V / In: LRCW1, 521–531

VILLA, L. 1994, Le anfore tra tardoantico e medioevo. – V / In: *Ad mensam. Manufatti d'uso da contesti archeologici tra tarda antichità e medioevo*, 335–431, Udine.

VILLA, L. 1998, Alcuni aspetti della circolazione di prodotti di importazione in Friuli tra V e VII secolo. – V / In: *Ceramica in Italia* 1998, 275–288.

VILLA, L. 2002, *Iulium Carnicum* e *Iulia Concordia*. Il destino di due centri urbani minori nell'altomedioevo. – *Aquileia Nostra* 73, 342–444.

VILLA, L. 2003, San Giorgio (Attimis – Ud.). Campagna di Scavo 2003. – *Quaderni Friuliani di Archeologia* 13, 297–309.

WAAGÉ, F. O. 1948, Hellenistic and Roman Tableware of North Syria. – *Antioch-on-the-Orontes* 4/1, *Ceramics and Islamic Coins*, 1–60.

WARNER SLANE, K. 2003, Corinth's roman pottery. Quantification and meaning. – V / In: C. K. Williams, N. Brookidis (ur. / eds.), *Corinth XX: The Centenary, 1896–1996*, 321–336, Princeton.

WILLIAMS, D. F. 1990, A Note on the Petrology of a *Samos Cistern Type* Amfora from Excavations at the Castello di Udine. – *Aquileia Nostra* 61, 295.

WILLIAMS, D. F. 2005a, Late Roman amphora 1: a study of diversification. – V / In: M. B. Briesse, L. E. Vaag (ur. / eds.), *Trade Relations in the Eastern Mediterranean from the Late Hellenistic Period to Late Antiquity: The Ceramic Evidence*, 157–168, Odense.

WILLIAMS, D. F. 2005b, An integrated archaeological approach to ceramic fabric recognition. A study case on Late Roman Amphora 1 from the Eastern Mediterranean. – V / In: LRCW1, 613–624.

ZULINI, E. 2007a, Terra sigillata africana. – V / In: Morselli 2007, 39–52.

ZULINI, E. 2007b, Produzioni africani. – V / In: Morselli 2007, 154–165.

ŽERJAL, T. 2008, *Rimska vila rustika v luči drobnih najdb: primer najdišča Školarice pri Spodnjih Škofijah*. – Neobjavljena doktorska disertacija / Unpublished doctoral thesis. Oddelek za arheologijo, Filozofska fakulteta Univerze v Ljubljani, Ljubljana.



# 5. NOVČNE NAJDBE

## 5. COIN FINDS

Peter KOS

### 5.1 KATALOG

Velika večina novcev s Tonovcovega gradu je že bila objavljena v treh zvezkih korpusa antičnih novčnih najdb s področja Slovenije, še zlasti v njegovem četrtem delu (FMRSL). Kljub temu na tem mestu še enkrat objavljamo katalog vsega novčnega gradiva z najdišča z navajanjem vseh relevantnih arheoloških podatkov.

V katalogu si pod posameznimi vladarji sledijo podatki o nominalu, dataciji kovanja posameznega novca, kovnici, standardni literaturi in prazniku kovnice.

Nominal: As = as; An = antoninianus; Cen = centenionalis; D = denarius; Dp = dupondius; Num = nummus; S = sestertius; Sil = siliqua; Tre = tremis. V poznem 4. stoletju so novci označeni po njihovi velikosti (AE 4 = najmanjši bronasti novce). Prav tako so označeni novci viminacijske kovnice (AE 1 = bronasti novce najvišje vrednosti).

Kovnice: Aq = Aquileia; Ale = Alexandria; Ant = Antiochia; Cyz = Cyzicus; Her = Heraclea; Med = Mediolanum; Rav = Ravenna; Rom = Roma; Sis = Siscia; Tes = Thessalonica; Tic = Ticinum; Vim = Viminacium.

Citati standardne literature: CNI = *Corpus Nummorum Italicorum: primo tentativo di un catalogo generale delle monete medievali e moderne coniate in Italia o da Italiani in altre paesi*, Roma, 1910–1943.

MIB = W. Hahn, *Moneta Imperii Byzantini, Bd. 1: Von Anastasius I. bis Iustinianus I. (491–565), einschliesslich der ostgotischen und vandalischen Prägungen*, Wien 1973.

MIR = R. Göbl, *Die Münzprägung der Kaiser Valerianus I., Gallienus, Saloninus (253/268), Regalianus (260) und Macrianus, Quietus (260/262)*, Wien 2000 (Denkschriften / Österreichische Akademie der Wissenschaften, Philosophisch-historische Klasse, Bd. 286. Veröffentlichungen der Numismatischen Kommission, Bd. 35) (MIR – Moneta Imperii Romani, Bd. 36; 43; 44).

R. Göbl, *Die Münzprägung des Kaisers Aurelianus (270/275)*, Wien 1993 (Denkschriften / Österreichische Akademie der Wissenschaften, Philosophisch-historische Klasse ; Bd. 233. Veröffentlichungen der Numismatischen Kommission, Bd. 29) (MIR – Moneta Imperii Romani, Bd. 47).

Pick = B. Pick, *Die antiken Münzen Nord-Griechenlands, Bd. I, I. Halbband. Die antiken Münzen von Dacien und Moesien*, Berlin 1898.

RIC = *The Roman Imperial Coinage V/2 – X*, London 1933–1994.

Vse novce hrani Goriški muzej, Nova Gorica (GM).

### 5.1 CATALOGUE

Most of the coins from Tonovcov grad have already been published in the three volumes of coin finds from the territory of Slovenia, especially in the fourth volume (FMRSL). Nevertheless, we are again publishing a catalogue of all coins from the site with all the relevant archaeological data.

In the catalogue the data about the denomination, minting date, mint, standard literature and mint-mark are given under individual rulers.

Denomination: As = as; An = antoninianus; Cen = centenionalis; D = denarius; Dp = dupondius; Num = nummus; S = sestertius; Sil = siliqua; Tre = tremissis. For the late 4<sup>th</sup> century the coins are marked according to their size (AE 4 = the smallest bronze coin). The coins of the mint of Viminacium are marked in the same way (AE 1 = bronze coin of the highest value).

Mints: Aq = Aquileia; Ale = Alexandria; Ant = Antiochia; Cyz = Cyzicus; Her = Heraclea; Med = Mediolanum; Rav = Ravenna; Rom = Roma; Sis = Siscia; Tes = Thessalonica; Tic = Ticinum; Vim = Viminacium.

Standard literature: CNI = *Corpus Nummorum Italicorum: primo tentativo di un catalogo generale delle monete medievali e moderne coniate in Italia o da Italiani in altre paesi*, Roma, 1910–1943.

MIB = W. Hahn, *Moneta Imperii Byzantini, Bd. 1: Von Anastasius I. bis Iustinianus I. (491–565), einschliesslich der ostgotischen und vandalischen Prägungen*, Wien 1973.

MIR = R. Göbl, *Die Münzprägung der Kaiser Valerianus I., Gallienus, Saloninus (253/268), Regalianus (260) und Macrianus, Quietus (260/262)*, Wien 2000 (Denkschriften / Österreichische Akademie der Wissenschaften, Philosophisch-historische Klasse, Bd. 286. Veröffentlichungen der Numismatischen Kommission, Bd. 35) (MIR – Moneta Imperii Romani, Bd. 36; 43; 44).

R. Göbl, *Die Münzprägung des Kaisers Aurelianus (270/275)*, Wien 1993 (Denkschriften / Österreichische Akademie der Wissenschaften, Philosophisch-historische Klasse ; Bd. 233. Veröffentlichungen der Numismatischen Kommission, Bd. 29) (MIR – Moneta Imperii Romani, Bd. 47).

Pick = B. Pick, *Die antiken Münzen Nord-Griechenlands, Bd. I, I. Halbband. Die antiken Münzen von Dacien und Moesien*, Berlin 1898.

RIC = *The Roman Imperial Coinage V/2 – X*, London 1933–1994.

All the coins are kept at the Goriški muzej, Nova Gorica (GM).

RIM / ROME					
Tiberius (Divus Augustus)					
1 As	22–30	Rom	RIC 81		
Vespasianus					
2 As	69–79	Rom	RIC ?		
Titus (Domitianus)					
3 As	80–81	Rom	RIC 169a		
Hadrianus					
4 D	134–138	Rom	RIC 338		
5 As	125–128	Rom	RIC 668c		
M. Aurelius					
6 –					
7 Dp	161–180	Rom	RIC ?		
8 Dp	170–171	Rom	RIC 1001		
Severus Alexander					
9 S	222–235	Rom	RIC ?		
10 S	233	Rom	RIC 535c		
Gordianus III.					
11 S	241–243	Rom	RIC 300a		
Gallienus					
12 An	260–261	Rom	RIC 325K MIR 373		
13 An	267–268	Rom	RIC 163K MIR 735b	Z	
14 An	267–268	Rom	RIC 166K MIR 718b	Δ	
15 An	267–268	Rom	RIC 181K MIR - (ad 716b)	X	
16 An	267–268	Rom	RIC 181K MIR 750b	XII	
17 An	260–268	?	RIC ? MIR ?	Σ	
(Salonina)					
18 An	260–268	?	RIC ? MIR ?	?	
Claudius II.					
19 An	268–270	Rom	RIC 103K	X	
20 An	268–270	Sis	RIC 193F		
Aurelianus					
21 An	270–275	Rom	RIC ? MIR ?	?	
22 An	272	Sis	RIC 225F MIR 199l-2	*S	

(Divus Claudius II.)				
23 An	270	?	RIC ?	
Probus				
24 An	276–282	Rom	RIC 173F	R≠B
25 An	276–282	Rom	RIC 202H	R*ε
26 An	276–282	?	RIC ?	?
Carus				
27 An	282–283	Rom	RIC 40F	B?
Carinus				
28 An	284–285	Rom	RIC 261F	KAF
Diocletianus				
29 An	284–294	Ant	RIC 325C	? <u>AC/Z</u>
Galerius				
30 Num	312	Ant	RIC 167b	ANT <u>Γ*</u>
Licinius I.				
31 Num	313–316	Tes	RIC 2	•T•S•A•
Constantinus I.				
32 Cen	318–319	Tic	RIC 82	TT
33 Cen	330–335	?	RIC ?	?
(Crispus)				
34 Cen	322–325	Tic	RIC 170	PT <u>ε</u>
35 Cen	326–327	Sis	RIC 201	<u>ΔSIS</u>
36 Cen	321–324	?	RIC ?	?
(Constantius II.)				
37 Cen	330–333	Her	RIC 113	SMHT
38 Cen	330–335	?	RIC ?	?
39 Cen	335–337	?	RIC ?	?
(Constantinopolis)				
40 Cen	334–335	Aq	RIC 123	AQS
41 Cen	330–337	?	RIC ?	?
Constantinus I. ali sinovi / Constantinus I or sons				
42 Cen	335–341	?	RIC ?	?
Constans				
43 Cen	341–348	Sis	RIC 182	ΓSIS
44 Cen	341–348	?	RIC ?	?
45 AE 3	348–350	?	RIC ?	?
Constantius II.				
46 AE 3	352–355	Aq	RIC 208	AQT <u>II</u>
47 –				
51 AE 3	351–361	?	RIC ?	?
52 AE 4	355–361	?	RIC ?	?

(Constantius Gallus)					
53 AE 2	351–354	Cyz	RIC 99	SMKε	
54 –					
55 AE 2	351–354	?	RIC ?	?	
(Iulianus)					
56 AE 3	355–361	Aq	RIC 213;214	AQ? <u>II</u>	
57 AE 3	355–361	Ale	RIC 88	ALEΔ	
Constantinus II., Constans ali / or Constantius II.					
58 –					
59 Cen	337–341	?	RIC ?	?	
Constans ali / or Constantius II.					
60 –					
61 Cen	341–348	?	RIC ?	?	
62 AE 2	348–361	?	RIC ?	?	
Magentius					
63 AE 2	351–352	Aq	RIC 170	⚡AQT⚡	
64 AE 2	351–352	Aq	RIC 173	AQS */z	
65 AE 2	351–352	?	RIC ? ?		
Valentinianus I.					
66 AE 3	364–367	Aq	RIC 7a i(b)	SMAQS <u>A</u>	
67 AE 3	367–375	Aq	RIC 11a xviii(a)	SMAQ? * <u>_</u>	
68 –					
70 AE 3	364–375	?	RIC ?	?	
Valens					
71 –					
77 AE 3	364–378	?	RIC ?	?	
Gratianus					
78 AE 2	378–383	Aq	RIC 30a 1	SMAQ	
79 AE 2	378–383	?	RIC ?	?	
80 AE 3	367–378	?	RIC ?	?	
Valentinianus I., Valens ali / or Gratianus					
81 AE 3	364–378	?	RIC ?	?	
Valentinianus II.					
82 AE	375–388	?	RIC ?	?	
Valentinianus I., Valens, Gratianus ali / or Valentinianus II.					
83 AE 3	364–378	?	RIC ?	?	
Theodosius I.					
84 AE 4	379–383	?	RIC ?	?	
Arcadius					
85 AE 4	395–402	Aq	RIC 1237	AQ?	
86 –					
89 AE 4	388–403	?	RIC ?	?	



Eudoxia					
90 AE 3	400–401	?	RIC ?	?	
Honorius					
91 AE 3	408–423	Rom	RIC 1355	SMRε	
92 –					
95 AE 3	408–423	Aq	RIC 1358	AQP	
96 –					
98 AE 3	408–423	Aq	RIC 1358	AQS	
99 –					
104 AE 3	408–423	Aq	RIC 1358	AQ?	
105 –					
107 AE 4	395–402	Aq	RIC 1238	AQS	
108 AE 4	395–402	Aq	RIC 1238	AQ?	
109 –					
114 AE 3	408–423	?	RIC ?	?	
115 –					
118 AE 4	393–403	?	RIC ?	?	
Arcadius ali / or Honorius					
119 –					
125 AE 4	388–403	?	RIC ?	?	
Valentinianus II., Theodosius I., Arcadius ali / or Honorius					
126 AE 4	388–393	Aq	RIC 58a-d 2	AQS	
127 AE 4	388–403	?	RIC ?	?	
Zeno (Odovacar)					
128 Tre	480–491	Med	RIC 3610	COMOB	
<b>Nedoločljiv / Undetermined</b>					
129 S	1.–2.st. / 1 <sup>st</sup> -2 <sup>nd</sup> cent.		Rom	RIC ?	
130 Dp	1.–2.st. / 1 <sup>st</sup> -2 <sup>nd</sup> cent.		Rom	RIC ?	
131 –					
133 As	1.–2.st. / 1 <sup>st</sup> -2 <sup>nd</sup> cent.		Rom	RIC ?	
134 An	2. pol. 3.st. / 2 <sup>nd</sup> half of the 3 <sup>rd</sup> cent.		?	RIC ?	
135 –					
136 An	2. pol. 3.st. / 2 <sup>nd</sup> half of the 3 <sup>rd</sup> cent.		?	RIC ?	?
137 Num	1. pol. 4.st. / 1 <sup>st</sup> half of the 4 <sup>th</sup> cent.		?	RIC ?	?
138 AE 2	2. pol. 4.st. / 2 <sup>nd</sup> half of the 4 <sup>th</sup> cent.		?	RIC ?	?
139 –					
149 AE 3	2. pol. 4.st. / 2 <sup>nd</sup> half of the 4 <sup>th</sup> cent.		?	RIC ?	?
150 –					
154 AE 4	2. pol. 4.st. / 2 <sup>nd</sup> half of the 4 <sup>th</sup> cent.		?	RIC ?	?
155 AE 4	2. pol. 4.–1.pol. 5.st. / 2 <sup>nd</sup> half of the 4 <sup>th</sup> -1 <sup>st</sup> half of the 5 <sup>th</sup> cent		?	RIC ?	?

## GRŠKI IMPERIALNI NOVCI / GREEK IMPERIAL COINS

## Moesia Superior

Traianus Decius

156 AE 1 250 Vim Pick 125 AN XI

## BIZANC / BYZANTIUM

## Iustinianus I.

157 1/4 Sil 540–552 Rav MIB 78

## VZHODNI GOTI / OSTROGOTHS

## Theoderich

(Anastasius)

158 –

159 1/4 Sil 492–518 Med MIB 44b

160 1/4 Sil 500–518 Rom MIB 39

(Iustinus I.)

161 10 Num 522–526 Rav MIB 72b

## Athalaric

(Iustinianus I.)

162 1/2 Sil 527–534 Rom MIB 53b

## NOVI VEK / POST MEDIAEVAL PERIOD

## Italija / Italy

Beneška republika / Venetian Republic

Antonio Priuli, Doge XCIV (1618–1623)

163 Soldo b. l. / no year Venezia CNI 203

- 1 GM N1762. Stavba 1, kv. 767/C1, SE 10. FMRSI IV 5-1. T.: 6,62g. Izrabljen.
- 2 GM N1772. Stavba 1, kv. 766/ C1, SE 10. Določitev po portretu. FMRSI IV 5-2. T.: 9,54g. Zelo močno izrabljen.
- 3 LJ 8305. Stavba 1, kv. 619/B2, SE 67. FMRSI IV 5-3. T.: 7,41g. Izrabljen.
- 4 GM N1678. Stavba 1, kv. 619/B2, SE 67. FMRSI IV 5-4. T.: 2,41g. Izrabljen.
- 5 LJ 8456. Stavba 1, kv. 719/D3, SE 26. FMRSI IV 5-5. T.: 9,19g. Dobro ohranjen.
- 6 GM N1753. Stavba 1, kv. 719/C4. FMRSI IV 5-6. T.: 10,99g. Izrabljen.
- 7 GM N1760. Stavba 1, kv. 719/C4. Določitev po portretu. FMRSI IV 5-7. T.: 10,98g. Zelo močno izrabljen.
- 8 LJ 8290. Izven izkopnega polja, v humusu. FMRSI IV 5-8. T.: 14,57g. Dobro ohranjen.
- 9 LJ 8289. Izven izkopnega polja, v humusu. FMRSI IV 5-9. T.: 13,64g. Zelo močno izrabljen.
- 10 LJ 8304. Izven izkopnega polja, v humusu. FMRSI IV 5-10. T.: 18,61g. Zelo lepo ohranjen.
- 11 LJ 15355. Izven izkopnega polja, v humusu. Dvojni kov. FMRSI IV 5-11. T.: 16,89g. Zelo lepo ohranjen.
- 12 GM. PN 350. Izven izkopnega polja, v humusu, kv. 864. T.: 2,05g. Dobro ohranjen.
- 13 GM N1749. Stavba 1, kv. 669/B2, SE 30. FMRSI IV 5-12. T.: 1,93g. Dobro ohranjen.
- 14 GM N1739. Stavba 1, kv. 766/A4, SE 24. FMRSI IV 5-13. T.: 1,74g. Dobro ohranjen.
- 15 GM N1744. Stavba 1, kv. 669/B3, SE 32. FMRSI IV 5-14. T.: 3,40g. Dobro ohranjen.
- 16 GM N1774. Stavba 1, kv. 817/D1, SE 03. FMRSI IV 5-15. T.: 2,37g. Zelo lepo ohranjen.
- 17 GM N1757. Izven izkopnega polja, v humusu, kv. 56. Fragmentiran. Tip: ?. FMRSI IV 5-16. T.: 1,35g. Izrabljen.
- 18 LJ 8302. Izven izkopnega polja, v humusu. FMRSI IV 5-17. T.: 1,74g. Izrabljen.
- 19 GM N1747. Stavba 1, kv. 817/D4. FMRSI IV 5-18. T.: 1,50g. Izrabljen.
- 20 GM N1741. Stavba 1, kv. 716/C3, SE 68. FMRSI IV 5-19. T.: 1,86g. Izrabljen.
- 21 GM N1701. Stavba 1, kv. 666/A3, SE 56. Av.: IMP AVRELIANVS AVG. Doprsje F. Tip: ?. FMRSI IV 5-20. T.: 3,06g. Izrabljen.
- 22 GM. Stavba 3, SE 172. T.: 1,99g. Zelo lepo ohranjen.
- 23 GM. Stavba 3, naključna najdba v izmetani zemlji. Tip: orel d. T.: 1,15g. Izrabljen.
- 24 LJ 7483. Stavba 1, kv. 666/A1, SE 34. FMRSI IV 5-21. T.: 2,14g. Izrabljen.
- 25 GM N1677. Stavba 1, kv. 666/A1, SE 34. FMRSI IV 5-22. T.: 3,24g. Dobro ohranjen.
- 26 GM. Cerkevni sklop – memorija, kv. 1375/C3, SE 02. Fragmentiran. Rv.: MARS VLTOR. Tip: Mars d. T.: 1,53g. Izrabljen.
- 27 GM N1754. Izven izkopnega polja, v humusu, kv. 56. FMRSI IV 5-23. T.: 2,72g. Dobro ohranjen.
- 28 LJ 7507. FMRSI IV 5-24. T.: 2,89g. Izrabljen.

- 29 GM N1748. Stavba 1, kv. 768/B1, SE 17. FMRSI IV 5-25. T.: 2,75g. Izrabljen.
- 30 GM N1676. Stavba 1, kv. 817/C1, SE 34. FMRSI IV 5-26. T.: 4,33g. Zelo lepo ohranjen.
- 31 GM N1704. Stavba 1, kv. 816/B3, SE 09. FMRSI IV 5-27. T.: 1,91g. Izrabljen.
- 32 LJ 7482. FMRSI IV 5-28. T.: 1,75g. Izrabljen.
- 33 GM N1691. Stavba 1, kv. 666/B2, SE 34. Polovičen. Tip: Gloria Exercitus, 2 vojaški znamenji. FMRSI IV 5-31. T.: 0,71g. Izrabljen.
- 34 GM N1761. Stavba 1, kv. 719/ D4. FMRSI IV 5-29. T.: 3,05g. Zelo lepo ohranjen.
- 35 LJ 5784. Stavba 1, kv. 619. T.: 2,24g. Izrabljen.
- 36 GM N1675. Stavba 1, kv. 569/D3, SE 34. Tip: Caesarum Nostrorum, Vot XX. FMRSI IV 5-30. T.: 1,44g. Izrabljen.
- 37 LJ 8457. Izven izkopnega polja, v humusu. FMRSI IV 5-32. T.: 2,14g. Izrabljen.
- 38 GM N1723. Stavba 1, kv. 716/C2, SE 23. Tip: Gloria Exercitus, 2 vojaški znamenji. FMRSI IV 5-33. T.: 1,77g. Dobro ohranjen.
- 39 GM N1690. Stavba 1, kv. 666/C2, SE 29. Tip: Gloria Exercitus, 1 vojaško znamenje. FMRSI IV 5-34. T.: 0,93g. Dobro ohranjen.
- 40 GM N1769. Stavba 1, kv. 669/A3, SE 29. FMRSI IV 5-35. T.: 0,83g. Izrabljen.
- 41 GM N1696. Stavba 1, kv. 666/B2, SE 34. FMRSI IV 5-36. T.: 1,11g. Izrabljen.
- 42 GM N1698. Stavba 1, kv. 716/B3, SE 34. Tip: Gloria Exercitus, 1 vojaško znamenje. FMRSI IV 5-39. T.: 0,60g. Zelo močno izrabljen.
- 43 LJ 5800. Izven izkopnega polja, v humusu. FMRSI III 7-2. T.: 1,02g. Izrabljen.
- 44 GM N1768. Stavba 1, kv. 720/A2, SE 01. Tip: Victoriae DD Auggq NN. FMRSI IV 5-40. T.: 1,19g. Izrabljen.
- 45 GM. Sklop cerkva, prostor med glavno in južno cerkvijo, kv. 1272, SE 107. Tip: Fel Temp Reparatio, galeja. T.: 1,40g. Zelo lepo ohranjen.
- 46 GM N1719. Stavba 1, kv. 769/C1. FMRSI IV 5-46. T.: 1,60g. Dobro ohranjen.
- 47 GM N1756. Izven izkopnega polja, v humusu, kv. 56. Fragmentiran. Tip: Fel Temp Reparatio, padajoči konjenik 3. FMRSI IV 5-53. T.: 2,18g. Izrabljen.
- 48 GM N1755. Izven izkopnega polja, v humusu, kv. 56. Tip: Fel Temp Reparatio, padajoči konjenik 3. FMRSI IV 5-54. T.: 2,07g. Izrabljen.
- 49 GM N1728. Stavba 1, kv. 716/A2, SE 24. Tip: Fel Temp Reparatio, padajoči konjenik 3. FMRSI IV 5-55. T.: 1,89g. Izrabljen.
- 50 LJ 7481. Izven izkopnega polja, v humusu. Tip: Fel Temp Reparatio, padajoči konjenik 4. FMRSI IV 5-56. T.: 1,83g. Zelo močno izrabljen.
- 51 LJ 5799. Izven izkopnega polja, v humusu. Tip: Fel Temp Reparatio, padajoči konjenik 3. FMRSI III 7-3. T.: 1,50g. Zelo močno izrabljen.
- 52 LJ 7901. Izven izkopnega polja, v humusu. Tip: Spes Reipublice. FMRSI IV 5-50. T.: 3,05g. Zelo močno izrabljen.
- 53 LJ 8301. Izven izkopnega polja, v humusu. FMRSI IV 5-47. T.: 4,26g. Izrabljen.
- 54 LJ 8375. Izven izkopnega polja, v humusu. Tip: Fel Temp Reparatio, padajoči konjenik 4. FMRSI IV 5-48. T.: 3,44g. Izrabljen.
- 55 LJ 8377. Izven izkopnega polja, v humusu. Tip: Fel Temp Reparatio, padajoči konjenik 4. FMRSI IV 5-49. T.: 2,71g. Izrabljen.
- 56 GM N1714. Stavba 1, kv. 669/ B2, SE 23. Fragmentiran. FMRSI IV 5-51. T.: 0,96g. Dobro ohranjen.
- 57 GM N1700. Stavba 1, kv. 666/A2,B2, SE 34. FMRSI IV 5-52. T.: 2,37g. Izrabljen.
- 58 GM N1716. Stavba 1, kv. 769/B2. Fragmentiran. Tip: Gloria Exercitus, 1 vojaško znamenje. FMRSI IV 5-37. T.: 0,66g. Zelo močno izrabljen.
- 59 GM N1779. Stavba 1, kv. 816/A1, SE 01. Fragmentiran. Tip: Gloria Exercitus, 1 vojaško znamenje. FMRSI IV 5-38. T.: 0,53g. Zelo močno izrabljen.
- 60 GM N1746. Stavba 1, kv. 817/D4. Tip: Victoriae DD Auggq NN. FMRSI IV 5-41. T.: 1,26g. Izrabljen.
- 61 GM N1771. Stavba 1, kv. 667/C3, SE 24. Tip: Victoriae DD Auggq NN. FMRSI IV 5-42. T.: 0,70g. Zelo močno izrabljen.
- 62 GM. Stavba 3, SE 150. Tip: Fel Temp Reparatio, padajoči konjenik (?). T.: 2,48g. Izrabljen.
- 63 GM N1776. Stavba 1, kv. 717/A1, SE 24. FMRSI IV 5-43. T.: 4,61g. Dobro ohranjen.
- 64 GM N1695. Stavba 1, kv. 820/ B4, SE 34. FMRSI IV 5-44. T.: 3,51g. Izrabljen.
- 65 GM N1703. Stavba 1, kv. 667/C4,D4. Tip: Victoriae DD NN Aug Et Caes, Vot V Mult X. FMRSI IV 5-45. T.: 3,94g. Izrabljen.
- 66 GM N1778. Stavba 1, 716/C2, SE 23. FMRSI IV 5-57. T.: 1,72g. Dobro ohranjen.
- 67 GM PN347. Izven izkopnega polja, v humusu, kv 470. T.: 1,87g. Dobro ohranjen.
- 68 GM N1706. Stavba 1, kv. 818/A2. Tip: Securitas Reipublicae. FMRSI IV 5-58. T.: 2,22g. Dobro ohranjen.
- 69 LJ 7899. Izven izkopnega polja, v humusu. Tip: Gloria Romanorum. FMRSI IV 5-59. T.: 1,54g. Zelo močno izrabljen.
- 70 GM N1707. Izven izkopnega polja, v humusu, kv. 476. Polovičen. Tip: Securitas Reipublicae. FMRSI IV 5-60. T.: 1,10g. Izrabljen.
- 71 LJ 8303. Izven izkopnega polja, v humusu. Tip: Gloria Romanorum. FMRSI IV 5-61. T.: 1,85g. Izrabljen.
- 72 GM N1697. Stavba 1, kv 918/C3, SE 34. Tip: Gloria Romanorum. FMRSI IV 5-62. T.: 1,84g. Izrabljen.
- 73 GM N1734. Stavba 1, kv. 668/A, SE 06. Tip: Gloria Romanorum. FMRSI IV 5-63. T.: 1,65g. Izrabljen.
- 74 GM N1705. Stavba 1, kv. 818/ B4, SE 01. Fragmentiran. Tip: Securitas Reipublicae. FMRSI IV 5-64. T.: 1,55g. Izrabljen.
- 75 LJ 7480. Izven izkopnega polja, v humusu. Tip: Securitas Reipublicae. FMRSI IV 5-65. T.: 1,33g. Izrabljen.
- 76 GM N1775. Stavba 1, kv. 719/ C2, SE 26. Fragmentiran. Tip: Gloria Romanorum. FMRSI IV 5-66. T.: 0,91g. Zelo močno izrabljen.
- 77 GM N1773. Stavba 1, kv. 719/ C3, SE 26. Polovičen. Tip: Gloria Romanorum. FMRSI IV 5-67. T.: 0,79g. Izrabljen.
- 78 GM N1763. Stavba 1, kv. 817/ A2,A3, SE10. FMRSI IV 5-70. T.: 3,46g. Dobro ohranjen.
- 79 GM N1745. Stavba 1, kv. 719/D3, SE 26. Tip: Reparatio Reipub. FMRSI IV 5-71. T.: 2,73g. Izrabljen.
- 80 LJ 8455. Izven izkopnega polja, v humusu. Tip: Gloria Romanorum. FMRSI IV 5-68. T.: 1,38g. Izrabljen.
- 81 LJ 5798. Izven izkopnega polja, v humusu. Tip: Gloria Romanorum. FMRSI III 7-4. T.: 1,37g. Izrabljen.
- 82 GM N1683. Stavba 1, kv. 666/A3, SE 29. Tip: Gloria Romanorum. FMRSI IV 5-73. T.: 1,76g. Izrabljen.
- 83 GM N1736. Stavba 1, kv. 666/D1, SE 06. Tip: Gloria Romanorum. FMRSI IV 5-69. T.: 1,08g. Zelo močno izrabljen.
- 84 LJ 8292. Izven izkopnega polja, v humusu. Tip: Vot XV Mult XX. FMRSI IV 5-72. T.: 1,01g. Izrabljen.
- 85 GM N1680. Stavba 1, kv. 918/A3, SE 34. FMRSI IV 5-74. T.: 0,62g. Dobro ohranjen.
- 86 GM N1688. Stavba 1, kv. 618/C2, SE 34. Tip: Salus Reipublicae. FMRSI IV 5-75. T.: 1,25g. Izrabljen.
- 87 GM. Cerkevni sklop – okolica, kv. 1120/ C1, SE 01. Tip: Salus Reipublicae. T.: 0,93g. Izrabljen.

- 88 GM N1759. Stavba 1, kv. 669/B1, SE 29. Tip: Salus Reipublicae. FMRSI IV 5-76. T.: 0,65g. Izrabljen.
- 89 GM. Cerkevni sklop – memorija, kv. 1375/A1, SE 04. Tip: Salus Reipublicae. T.: 0,50g. Dobro ohranjen.
- 90 GM. Izven izkopnega polja, kv. 1064, v humusu. Tip: Gloria Romanorum 24. T.: 1,01g. Izrabljen.
- 91 GM N1729. Stavba 1, kv. 669/A2, SE 29. FMRSI IV 5-92. T.: 2,48g. Dobro ohranjen.
- 92 GM N1718. Stavba 1, kv. 769/A2. FMRSI IV 5-93. T.: 2,08g. Dobro ohranjen.
- 93 GM N1737. Stavba 1, kv. 719/C3, SE 04. FMRSI IV 5-94. T.: 1,86g. Zelo lepo ohranjen.
- 94 GM N1693. Stavba 1, kv. 619/ C3, SE 68. FMRSI IV 5-95. T.: 1,66g. Zelo lepo ohranjen.
- 95 GM N1752. Stavba 1, kv. 716/D1. FMRSI IV 5-96. T.: 1,09g. Izrabljen.
- 96 LJ 15528. Stavba 1, kv. 820/B4, SE 34. FMRSI IV 5-97. T.: 1,74g. Dobro ohranjen.
- 97 GM N1764. Stavba 1, kv. 720, SE 34. FMRSI IV 5-98. T.: 1,60g. Dobro ohranjen.
- 98 GM N1743. Stavba 1, kv. 769/C2. FMRSI IV 5-99. T.: 1,32g. Dobro ohranjen.
- 99 GM N1742. Stavba 1, kv. 769/C1. FMRSI IV 5-100. T.: 2,59g. Dobro ohranjen.
- 100 GM N1709. Stavba 1, kv. 719/C3. FMRSI IV 5-101. T.: 2,38g. Zelo lepo ohranjen.
- 101 GM N1681. Stavba 1, kv. 715/D3, SE 04. FMRSI IV 5-102. T.: 1,42g. Dobro ohranjen.
- 102 GM N1717. Stavba 1, kv. 669/C4, SE 24. Fragmentiran. FMRSI IV 5-103. T.: 1,31g. Izrabljen.
- 103 GM N1720. Stavba 1, kv. 769/C1. Fragmentiran. FMRSI IV 5-104. T.: 1,21g. Izrabljen.
- 104 GM N1685. Stavba 1, kv. 666/B4, SE 52. Fragmentiran. FMRSI IV 5-105. T.: 0,69g. Dobro ohranjen.
- 105 GM N1726. Stavba 1, kv. 766/A4, SE 24. FMRSI IV 5-77. T.: 1,03g. Dobro ohranjen.
- 106 GM N1733. Stavba 1, kv. 669/B1, SE 29. FMRSI IV 5-78. T.: 0,86g. Dobro ohranjen.
- 107 GM N1679. Stavba 1, kv. 666/ C4, SE 57. FMRSI IV 5-79. T.: 0,61g. Dobro ohranjen.
- 108 GM N1694. Stavba 1, kv. 919/A1, SE 34. FMRSI IV 5-80. T.: 0,57g. Izrabljen.
- 109 GM N1780. Stavba 1, kv. 867/B1, SE 03. Tip: Gloria Romanorum 11. FMRSI IV 5-106. T.: 2,68g. Zelo lepo ohranjen.
- 110 GM N1724. Stavba 1, kv. 868/A1, SE 06. Tip: Gloria Romanorum 11. FMRSI IV 5-107. T.: 2,39g. Zelo lepo ohranjen.
- 111 GM N1730. Stavba 1, kv. 769/C2, SE 03. Objekt 1Z. Tip: Gloria Romanorum 11. FMRSI IV 5-108. T.: 2,33g. Izrabljen.
- 112 GM N1692. Stavba 1, kv. 619/B3, SE 68. Tip: Gloria Romanorum 11. FMRSI IV 5-109. T.: 2,11g. Dobro ohranjen.
- 113 GM N1766. Stavba 1, kv. 716/ B4, SE 23. Tip: Gloria Romanorum 11. FMRSI IV 5-110. T.: 2,04g. Izrabljen.
- 114 GM N1767. Stavba 1, kv. 766/ D3. Tip: Gloria Romanorum 11. FMRSI IV 5-111. T.: 1,68g. Dobro ohranjen.
- 115 GM N1689. Stavba 1, kv. 917/D2, SE 34. Tip: Salus Reipublicae. FMRSI IV 5-81. T.: 1,08g. Dobro ohranjen.
- 116 GM N1750. Stavba 1, kv. 817/C4, SE 03. Tip: Salus Reipublicae. FMRSI IV 5-82. T.: 0,90g. Izrabljen.
- 117 GM N1687. Stavba 1, kv. 618/A3, SE 34. Tip: Salus Reipublicae. FMRSI IV 5-83. T.: 0,86g. Izrabljen.
- 118 GM N1715. Stavba 1, kv. 769/C1. Tip: Salus Reipublicae. FMRSI IV 5-84. T.: 0,85g. Zelo lepo ohranjen.
- 119 GM N1765. Stavba 1, kv. 667/ D4, SE 24. Tip: Salus Reipublicae. FMRSI IV 5-85. T.: 1,03g. Zelo močno izrabljen.
- 120 GM N1708. Izven izkopnega polja, kv. 476. Humus. Tip: Salus Reipublicae. FMRSI IV 5-86. T.: 0,89g. Izrabljen.
- 121 GM N1731. Stavba 1, kv. 768/B2, SE 03. Tip: Salus Reipublicae. FMRSI IV 5-87. T.: 0,86g. Izrabljen.
- 122 GM N1684. Stavba 1, kv. 666/C3, SE 50. Tip: Salus Reipublicae. FMRSI IV 5-88. T.: 0,80g. Izrabljen.
- 123 GM N1732. Izven izkopnega polja, v humusu, kv. 56. Tip: Salus Reipublicae. FMRSI IV 5-89. T.: 0,78g. Izrabljen.
- 124 GM N1686. Stavba 1, kv. 771/B1, SE 69. Tip: Salus Reipublicae. FMRSI IV 5-90. T.: 0,78g. Izrabljen.
- 125 GM N1751. Stavba 1, kv. 669/ D3, SE 30. Tip: Salus Reipublicae. FMRSI IV 5-91. T.: 0,61g. Izrabljen.
- 126 GM. Cerkevni sklop – okolica, kv. 1120/C1. T.: 0,90g. Izrabljen.
- 127 GM. Cerkevni sklop – okolica. Kv. 1120/D1. Tip: Salus Reipublicae. T.: 0,63g. Izrabljen.
- 128 LJ 25149. Stavba 1, kv. 918/D3, SE 34. FMRSI V 4-1. T.: 1,45g. Odlično ohranjen.
- 129 GM N1738. Stavba 1, kv. 767/C1, SE 10. FMRSI IV 5-112. T.: 12,81g. Zelo močno izrabljen.
- 130 LJ 8188. Izven izkopnega polja, v humusu. FMRSI IV 5-113. T.: 6,03g. Zelo močno izrabljen.
- 131 LJ 8454. Izven izkopnega polja, v humusu. FMRSI IV 5-114. T.: 6,32g. Zelo močno izrabljen.
- 132 LJ 8189. Izven izkopnega polja, v humusu. FMRSI IV 5-115. T.: 5,36g. Zelo močno izrabljen.
- 133 GM N1735. Izven izkopnega polja, v humusu. Fragmentiran. FMRSI IV 5-116. T.: 4,89g. Zelo močno izrabljen.
- 134 LJ 5801. Izven izkopnega polja, v humusu. FMRSI III 7-5. T.: 1,50g. Zelo močno izrabljen.
- 135 GM N1777. Stavba 1, kv. 716/A4, SE 23. FMRSI IV 5-117. T.: 3,81g. Zelo močno izrabljen.
- 136 GM N1674. Stavba 1, kv. 669/B4, SE 24. FMRSI IV 5-118. T.: 1,21g. Zelo močno izrabljen.
- 137 LJ 7508. Izven izkopnega polja, v humusu. FMRSI IV 5-119. T.: 0,94g. Zelo močno izrabljen.
- 138 GM N1727. Stavba 1, kv. 666/D3, SE 23. FMRSI IV 5-120. T.: 3,47g. Zelo močno izrabljen.
- 139 GM N1682. Stavba 1, kv. 666/C2, SE 56. FMRSI IV 5-121. T.: 1,77g. Zelo močno izrabljen.
- 140 GM N1702. Stavba 1, kv. 716/D1, SE 24. FMRSI IV 5-122. T.: 1,33g. Zelo močno izrabljen.
- 141 GM N1722. Stavba 1, kv. 720/A1, SE 01. FMRSI IV 5-123. T.: 1,29g. Zelo močno izrabljen.
- 142 GM N1699. Stavba 1, kv. 968/A3, SE 34. FMRSI IV 5-124. T.: 1,21g. Zelo močno izrabljen.
- 143 GM N1758. Stavba 1, kv. 669/B2,D2, SE 07. FMRSI IV 5-125. T.: 1,14g. Zelo močno izrabljen.
- 144 GM N1781. Izven izkopnega polja, v humusu, kv.762/763. FMRSI IV 5-126. T.: 1,07g. Zelo močno izrabljen.
- 145 GM N1673. Stavba 1, kv. 618/D3, SE 34. FMRSI IV 5-127. T.: 0,93g. Zelo močno izrabljen.
- 146 GM N1710. Stavba 1, kv. 769/A2, SE 03. FMRSI IV 5-128. T.: 0,85g. Zelo močno izrabljen.
- 147 GM N1721. Izven izkopnega polja, v humusu, kv. 1115. FMRSI IV 5-129. T.: 0,70g. Zelo močno izrabljen.
- 148 LJ 7900. Izven izkopnega polja, v humusu. FMRSI IV 5-130. T.: 0,58g. Zelo močno izrabljen.
- 149 GM N1740. Stavba 1, kv. 765/C4, SE 06. Fragmentiran. FMRSI IV 5-131. T.: 0,54g. Zelo močno izrabljen.
- 150 GM N1770. Stavba 1, kv. 766/B2, SE 23. FMRSI IV 5-132. T.: 1,00g. Zelo močno izrabljen.
- 151 GM N1713. Stavba 1, kv. 718/D4, SE 10. Ožgan. FMRSI IV 5-133. T.: 0,85g. Zelo močno izrabljen.
- 152 GM N1712. Stavba 1, kv. 669/B1, SE 24. FMRSI IV 5-134. T.: 0,67g. Zelo močno izrabljen.
- 153 LJ 8291. Izven izkopnega polja, v humusu. FMRSI IV 5-135. T.: 0,65g. Zelo močno izrabljen.

- 154 GM N1711. Stavba 1, kv. 720/B2, SE 01. FMRSI IV 5-136. T.: 0,46g. Zelo močno izrabljen.  
 155 GM. Stavba 2, kv. 1178/C1, SE 106. T.: 0,35g. Zelo močno izrabljen.  
 156 LJ 8376. Izven izkopnega polja, v humusu. Polovičen. FMRSI IV 5-137. T.: 7,78g. Izrabljen.  
 157 LJ 25150. Cerkevni sklop – prezbitarij glavne cerkve, v amfori, kv. 1325/C1. FMRSI V 4-2. T.: 0,75g. Zelo lepo ohranjen.  
 158 LJ 14056. Stavba 1, kv. 769/A2, SE 03. FMRSI IV 5-138. T.: 0,81g. Odlično ohranjen.  
 159 LJ 14057. Kvadrant 669/C4, SE 01. FMRSI IV 5-139. T.: 0,80g. Odlično ohranjen.  
 160 LJ 14058. Izven izkopnega polja, v humusu, kv. 865/C4. FMRSI IV 5-140. T.: 0,69g. Odlično ohranjen.  
 161 LJ 14059. Stavba 1, kv. 719/C2, SE 08. FMRSI IV 5-141. T.: 3,08g. Zelo lepo ohranjen.  
 162 Pr.l. Izven izkopnega polja, v humusu. FMRSI III 7-6. Demo 1994, str. 92 kat. št. 142, str. 144. T.: 1,32g. Odlično ohranjen.  
 163 GM N1725. Izven izkopnega polja, v humusu. T.: 1,74g. Izrabljen.

## 5.2 OVREDNOTENJE NOVČNIH NAJDB

### 5.2.1 RIMSKI NOVCI

Na območju naselbine je bilo mogoče dokumentirati 156 rimskih novcev (*tab. 5.1*). Za primerjavo navajamo še podatke o zastopanosti novčnih najdb na štirih poznorimskih najdiščih v severovzhodni in severni Italiji: Concordija,<sup>1</sup> Castellazzo pri Doberdobu,<sup>2</sup> območje Altina<sup>3</sup> ter Trento.<sup>4</sup>

Novci 1. in 2. stoletja (8 primerkov oziroma 5,1 %) so zelo močno izrabljeni, na osnovi česar je mogoče zaključiti, da so prišli v zemljo po razmeroma dolgi uporabi.<sup>5</sup> Zato nikakor niso dokaz, da bi se ta denar v naselbini morda uporabljala že v omenjenem obdobju.

O rednem dotoku denarja v obtok na naselbini je mogoče govoriti šele od druge polovice 3. stoletja (*tab. 5.2*), ko je med najdbami zastopanih več antoninijanov (13,5 % vseh na najdišču dokumentiranih rimskih novčnih najdb).

Skupno število na najdišču dokumentiranih antoninijanov druge polovice 3. stoletja je številčno sicer skromno, vendar procentualna zastopanost novcev posameznih vladarjev ne odstopa bistveno od vrednosti na nekaterih primerjalnih najdiščih (npr. Rim,<sup>6</sup> Ajdovščina,<sup>7</sup> Hrušica<sup>8</sup>). Njihov znaten procentualni delež med vsemi rimskimi novčnimi najdbami (13,5 %) na najdišču pa odstopa predvsem od nizkih vrednosti na treh severovzhodnih italjskih najdiščih (Concordija, Castellazzo pri Doberdobu, Trento; *tab. 5.1*). Pri interpretaciji teh najdb se moramo zavedati dejstva, da so bili antoninijani tega obdobja v obtoku lahko zelo dolgo, saj so (sicer v majhni meri) zastopani še v zakladnih najdbah konca 3. oziroma samega začetka 4. stoletja, kar pomeni, da so bili v uporabi še v času zakopa zakla-

## 5.2 EVALUATION OF THE COIN FINDS

### 5.2.1 ROMAN COINS

156 Roman coins were documented within the settlement (*Tab. 5.1*). As a comparison we looked at data for coin finds from four Late Roman sites in northeastern and northern Italy: Concordia,<sup>1</sup> Castellazzo near Doberdob,<sup>2</sup> the Altino area<sup>3</sup> and Trento.<sup>4</sup>

The 1<sup>st</sup> and 2<sup>nd</sup> centuries coins (8 examples or 5.1 %) show strong signs of use, which leads us to believe that they arrived in the soil only once they were in use for a relatively long time.<sup>5</sup> Therefore there is no evidence that this money was actually used in the settlement as early as the 1<sup>st</sup> or 2<sup>nd</sup> century.

We can talk about a regular influx of money into circulation (at the settlement) only from the second half of the 3<sup>rd</sup> century onwards (*Tab. 5.2*), when the finds include a greater number of antoniniani (13.5 % of all Roman coins documented at the site).

The total number of documented antoniniani from the second half of the third century is modest, however the percentages of coins of individual rulers do not differ greatly from the proportions at certain comparable sites (e.g. Rome,<sup>6</sup> Ajdovščina,<sup>7</sup> Hrušica<sup>8</sup>). Their high share amongst all Roman coin finds (13.5 %) differs from the low shares at the three northeastern Italian sites (Concordia, Castellazzo near Doberdob, Trento; *Tab. 5.1*). When interpreting these finds, we have to keep in mind that the radiates from this period were in circulation for a very long time, for they are represented (in modest numbers) even in hoards from the end of the 3<sup>rd</sup> and beginning of the 4<sup>th</sup> centuries, which means that they were still in use when the hoard was buried. In some parts of the Empire, sporadic coin finds that can be placed with certainty into

<sup>1</sup> Bonomi 1988, 165–168; Arzone 1988, 190–199; Arzone 1989, 135–140.

<sup>2</sup> Ahumada Silva 1989, 84–85.

<sup>3</sup> Asolati, Crisafulli 1999, 53 (Ac).

<sup>4</sup> Callegher 1998.

<sup>5</sup> O problematiki izrabe novcev zaradi dolgotrajnega obtoka glej Delamare 1994.

<sup>6</sup> Reece 1982, 116 ss (= Reece 2003, 192 ss)

<sup>7</sup> FMRSI I 13; FMRSI III 12.

<sup>8</sup> FMRSI I 17-1; FMRSI III 15.

<sup>1</sup> Bonomi 1988, 165–168; Arzone 1988, 190–199; Arzone 1989, 135–140.

<sup>2</sup> Ahumada Silva 1989, 84–85.

<sup>3</sup> Asolati, Crisafulli 1999, 53 (Ac).

<sup>4</sup> Callegher 1998.

<sup>5</sup> For signs of coin use due to a lengthy time in circulation see Delamare 1994.

<sup>6</sup> Reece 1982, 116 ff. (= Reece 2003, 192 ff.). Bertoldi 1997.

<sup>7</sup> FMRSI I 13; FMRSI III 12.

<sup>8</sup> FMRSI I 17-1; FMRSI III 15.

Tab. 5.1: Primerjava deleža novcev z omenjenih najdišč po obdobjih.

Tab. 5.1: The comparison of coin shares from the aforementioned sites, by periods.

	Tonovcov grad	Concordia (Quartiere Nord Ovest)	Castellazzo (zakladna najdba / hoard)	Altino (zakladna najdba / hoard)	Trento (Teatro sociale)
Republika / Republic		1 (0,8%)			1 (0,1%)
1. pol. 1. st. / 1 <sup>st</sup> half of the 1 <sup>st</sup> cent.	1 (0,6%)	2 (1,6%)	1 (0,1%)		
2. pol. 1. st. / 2 <sup>nd</sup> half of the 1 <sup>st</sup> cent.	2 (1,3%)				
1. pol. 2. st. / 1 <sup>st</sup> half of the 2 <sup>nd</sup> cent.	2 (1,3%)	1 (0,8%)			
2. pol. 2. st. / 2 <sup>nd</sup> half of the 2 <sup>nd</sup> cent.	3 (1,9%)				
1.-2.st. / 1 <sup>st</sup> - 2 <sup>nd</sup> cent.	5 (3,2%)				8 (0,5%)
1. pol. 3. st. / 1 <sup>st</sup> half of the 3 <sup>rd</sup> cent.	4 (2,5%)	1(0,8%)	2 (0,2%)		
2. pol. 3. st. / 2 <sup>nd</sup> half of the 3 <sup>rd</sup> cent.	21 (13,5%)	4 (3,2%)		32 (10%)	16 (1,1%)
1. pol. 4. st. / 1 <sup>st</sup> half of the 4 <sup>th</sup> cent.	22 (14%)	36 (24,2%)	14 (1,6%)	56 (17,5%)	281 (18,9%)
2. pol. 4. st. / 2 <sup>nd</sup> half of the 4 <sup>th</sup> cent.	75 (48%)	49 (39,5%)	186 (21,3%)	138 (43,1%)	900 (60,6%)
4. st. / 4 <sup>th</sup> cent.		4 (3,2%)			58 (3,9%)
1. pol. 5. st. / 1 <sup>st</sup> half of the 5 <sup>th</sup> cent.	20 (12,8%)	18 (14,5%)	202 (23,1%)	50 (15,6%)	
2. pol. 5. st. / 2 <sup>nd</sup> half of the 5 <sup>th</sup> cent.	1 (0,6%)				
2. pol. 4.-1. pol. 5. st. / 2 <sup>nd</sup> half of the 4 <sup>th</sup> - 1 <sup>st</sup> half of the 5 <sup>th</sup> cent.	1 (0,6%)	14 (11,3%)	469 (53,6%)	44 (13,7%)	204 (13,7%)
Skupaj / Total	156	124	874	320	1485

Tab. 5.2: Zastopanost antoninijanov posameznih kovnih obdobjih druge polovice 3. stoletja.

Tab. 5.2: The share of radiates from individual minting periods in the second half of the 3<sup>rd</sup> century.

Obdobje kovanja / Minting period	Kovnica / Mint				
	Rom	Sis	Ant	Ned. / Indet.	Skupaj / Total
260-268	5			2	7 (38,9%)
268-270	1	1			2 (11,1%)
270-275	1	1		1	3 (16,6%)
275-282	2			1	3 (16,6%)
282-284	2				2 (11,1%)
284-294			1		1 (5,55%)
Skupaj / Total	11	2	1	4	18

da. Poleg tega tudi analize sporadičnih novčnih najdb dokumentirajo ponekod v imperiju na osnovi njihove nedvoumne umestitve v posamezne stratigrafske enote prisotnost antoninijanov oziroma njihovo ponovno

certain stratigraphic units clearly indicate that antoniniani were reused as late as the late 4<sup>th</sup> century.<sup>9</sup> The comparison

<sup>9</sup> Depeyrot 1999, 57 ff. The presence of 3<sup>rd</sup> century coins in post-Theodosian hoards is shown by Delmaire 1983, 143 ff.

Tab. 5.3: Zastopanost novcev posameznih kovnih obdobij prve polovice 4. stoletja po kovnicah.

Tab. 5.3: Shares of coins from individual minting periods in the first half of the 4<sup>th</sup> century, by mints.

Obdobje kovanja / Minting period	Kovnica / Mint									Skupaj / Total
	Tic	Aq	Sis	Her	Tes	Ant	Ale	Cyz	Nedoločljiva kovnica / Mint indeterminable	
312–320	1				1	1				3 (8,3%)
321–330	1		1						1	3 (8,3%)
330–337		1		1					4	6 (16,7%)
335–341									3	3 (8,3%)
341–348			1						3	4 (11,1%)
348–361									1	1 (2,8%)
351–354		3						1	3	7 (19,4%)
351–361									5	5 (13,9%)
355–361		1					1		1	3 (8,3%)
Skupaj / Total	2	5	2	1	1	1	1	1	22 (61%)	36

uporabo še v poznem 4. stoletju.<sup>9</sup> Za analizo in interpretacijo novčnih najdb 3. stoletja na Tonovcovem gradu je zanimiva primerjava strukture novčnih najdb v Trentu (*Tridentum*), kjer naj bi po Callegherju vsi najdeni novci (torej tudi skromen delež antoninijanov) predstavljali denarni obtok zadnjih dvajsetih let 4. stoletja oziroma prvih let 5. stoletja.<sup>10</sup> Zakladna najdba z območja Altina (*Altinum*) v Benečiji kaže podobne procentualne deleže zastopanosti novcev posameznih obdobij kot Tonovcov grad (tab. 5.1), vendar je bila zakopana šele v tretjem ali četrtem desetletju 5. stoletja, kar kaže na to, da bi bili vsi novci v njenem sestavu (torej tudi dobro zastopani antoninijani druge polovice 3. stoletja) v času zakopa najdbe lahko še v uporabi.<sup>11</sup>

Na osnovi številčno razmeroma skromnih najdb antoninijanov na Tonovcovem gradu (med katerimi jih veliko kaže znake precejšnje izrabe) zato ne moremo z gotovostjo ugotavljati, da bi novci v denarni obtok v naselbini zašli že kmalu po njihovem kovanju. Le dobro ohranjeni srebrniki samostojne Galijenove vlade (kat. št. 12–16) bi sicer lahko dokazovali njihovo uporabo v naselbini že vsaj v sredini druge polovice 3. stoletja. Na osnovi dobre ohranjenosti antoninijanov Proba (kat. št. 25) in Kara (kat. št. 27) je tudi njuno uporabo v naselbini mogoče domnevati vsaj v zadnjem desetletju 3. stoletja. Najdbe antoninijanov, ki ne kažejo močne izrabe, tako verjetno odražajo prvo občasno prisotnost prebivalstva na vzpetini proti koncu 3. stoletja.

of the structure of the coin finds in Trento (*Tridentum*) is interesting for the analysis and interpretation of the 3<sup>rd</sup> century coin finds at Tonovcov grad. According to Callegher, all the discovered coins (also including the modest share of antoniniani) represented the monetary circulation during the final twenty years of the 4<sup>th</sup> century and the first years of the 5<sup>th</sup> centuries.<sup>10</sup> The hoard from Altino (*Altinum*) in the Venetian territories shows similar shares of coins from individual periods as at Tonovcov grad (Tab. 5.1), even though it was buried only in the third or fourth decade of the 5<sup>th</sup> century. This indicates that all coins in the hoard (including the well-represented antoniniani from the second half of the 3<sup>rd</sup> century) could have been in use at the time the hoard was buried.<sup>11</sup>

In terms of the modest finds (as regards the numbers) of antoniniani at Tonovcov grad (amongst which a number of them show signs of long-term use), we cannot ascertain with certainty that the coins were used within the settlement soon after they were minted. Only the well preserved silver coins dating to the sole rule of Gallienus (Cat. Nos. 12-16) could indicate that they were used in the settlement from at least the middle of the second half of the 3<sup>rd</sup> century. From the good condition of the antoniniani of Probus (Cat. No. 25) and Carus (Cat. No. 27), their use in the settlement can be assumed at least in the last decade of the 3<sup>rd</sup> century. The finds of antoniniani that do not show great use can thus reflect the first occasional presence of inhabitants on the elevation towards the end of the 3<sup>rd</sup> century.

Coins from the first half of the 4<sup>th</sup> century (Tab. 5.3) are relatively modestly represented at the site (14 % of all Roman coins). Not all minting periods are represented,

<sup>9</sup> Depeyrot 1999, 57 ss. Podatke za prisotnost novcev 3. stoletja v post-teodozijanskih zakladnih najdbah navaja Delmaire 1983, 143 ss.

<sup>10</sup> Callegher 1998, 83.

<sup>11</sup> Asolati, Crisafulli 1999, 53(Ac).

<sup>10</sup> Callegher 1998, 83.

<sup>11</sup> Asolati, Crisafulli 1999, 53 (Ac).

Tab. 5.4: Zastopanost novcev posameznih kovnih obdobij druge polovice 4. in začetka 5. stoletja po kovnicah.

Tab. 5.4: Shares of coins from individual minting periods in the second half of the 4<sup>th</sup> and beginning of the 5<sup>th</sup> centuries, by mint.

Obdobje kovanja / Minting period	Kovnica / Mint			
	Roma	Aquileia	Nedoločljiva kovnica / Mint indeterminable	Skupaj / Total
364–378		2	13	15 (24,2%)
378–383		1	2	3 (4,8%)
375–388			1	1 (1,6%)
388–403		1	12	13 (20,9%)
393–403			4	4 (6,4%)
395–403		5	1	6 (9,7%)
408–423	1	13	6	20 (32,2%)
Skupaj / Total	1 (1,6%)	22 (35,4%)	39 (62,9%)	62

Tab. 5.5: Delež novcev posameznih vladarjev po tipih v kovnem obdobju 364–378.

Tab. 5.5: Shares of coins of individual rulers, by types, in the minting period 364–378.

	Securitas Reipublicae AE 3	Gloria Romanorum AE 3	Skupaj / Total
Valentinianus I.	2	3	5 (33,3%)
Valens	2	5	7 (46,6%)
Gratianus		1	1 (6,6%)
Valentinianus I., Valens, Gratianus ali / or Valen- tinianus II.		2	2 (13,3%)
Skupaj / Total	4 (26,6%)	11 (73,3%)	15

Novci prve polovice 4. stoletja (*tab. 5.3*) so na najdišču razmeroma skromno zastopani (14 % vseh rimskih novcev), prav tako niso dokumentirani novci vseh kovnih obdobij, stopnja njihove ohranjenosti pa se giblje med zelo dobro ohranjenostjo in zelo močno izrabljenostjo. Zato je upravičena domneva, da prisotnost teh novcev ne more odražati intenzivnejše poselitve naselbinskega prostora v tem obdobju.

Skoraj polovica vseh rimskih novcev iz obdobja 1.–5. stoletja (48 %) je bila kovana v drugi polovici 4. stoletja.

Iz obdobja 364–423 je bilo dokumentiranih 62 (39,7 %) določljivih bronastih novcev, katerih strukturo prikazuje *tabela 5.4*.

15 (24 %) novcev druge polovice 4. stoletja in prve polovice 5. stoletja je iz valentinijanskega obdobja (364–378). Strukturo bronastih novcev tega obdobja na najdišču prikazuje naslednja preglednica (*tab. 5.5*).

Zastopanost novcev posameznih vladarjev v tem obdobju ne odstopa od povprečnih vrednosti v rimskem imperiju, kjer je običajna večja prisotnost novcev Valensa,<sup>12</sup> kar je pričakovano glede na njegovo daljše

and the level of preservation ranges between very well preserved to very poorly preserved. Thus it can be justifiably assumed that the presence of these coins cannot reflect a more intense settlement of the area in this period.

48 % of all 1<sup>st</sup> to 5<sup>th</sup> century Roman coins were minted in the second half of the 4<sup>th</sup> century.

62 identifiable (39.7 %) bronze coins dating between 364 and 423 AD were discovered. Their structure is shown in the *table 5.4*.

15 coins (24 % of all coins) from the second half of the 4<sup>th</sup> century and the first half of the 5<sup>th</sup> century can be dated to the Valentinian period (364–378). The shares of bronze coins from this period (at this site) are shown in the next table (*Tab. 5.5*).

In this period the shares of coins of individual rulers do not differ from the average values in the Roman Empire. The most common are coins of Valens,<sup>12</sup> which is to be expected as he ruled for a long period of time and thus the coins were minted for a longer period than most. At this site the ratio of the two bronze coin types

<sup>12</sup> Prim. npr. vrednosti za Conimbrigo v Luzitaniji (Valentinianus I. : Valens : Gratianus = 32,8 % : 60,6 % : 6,5 %) v: Pereira, Bost 1974, 286 ss. Glej tudi podatke za antični Tri-

<sup>12</sup> For instance, compare the values for Conimbriga in Lusitania (Valentinianus I. : Valens : Gratianus = 32.8 % : 60.6 % : 6.5 %) in: Pereira, Bost 1974, 286 ff. See also data for Late Roman Tridentum (Trento): Callegher 1998, 50.



vladanje in kovanje. Razmerje zastopanosti obeh v tem obdobju kovanih tipov bronastih novcev (*Securitas Reipublicae* : *Gloria Romanorum* = 26,6 % : 73,3 %) na najdišču sicer odstopa od vrednosti, ki so najpogosteje dokumentirane v imperiju. Največkrat namreč prevladujejo novci tipa *Securitas Reipublicae*,<sup>13</sup> podobno sliko pa kaže tudi zakladna najdba s področja Altina v Benečiji (najmlajši novci v njej so iz obdobja 410–467), kjer novci tipa *Securitas Reipublicae* prevladujejo s 85 %.<sup>14</sup> Med posamičnimi novčnimi najdbami v Trentu (*Tridentum*) prav tako prevladujejo novci tipa *Securitas* s 70,4 %.<sup>15</sup> Podobno razmerje kot na Tonovcovemu gradu je sicer dokumentirano v zakladni najdbi Alte Ceccato (Vicenza), v kateri so najmlajši novci iz obdobja 394–403 (*Securitas Reipublicae* : *Gloria Romanorum* = 40,9 % : 59,1 %).<sup>16</sup>

Trije novci sredine 4. stoletja (kat. št. 33, 70, 77) so polovičeni, torej namenoma presekan na polovico, kar je običajen fenomen v obdobjih pomanjkanja drobiža. Na polovico presekan novci so na vzhodu imperija pogosto zastopani v zakladnih najdbah 5. in začetka 6. stoletja. Glede na dejstvo, da se polovičeni novci ne pojavljajo v zakladnih najdbah, ki so bile zakopane pred letom 423, pa M. Vasić domneva, da so bili polovičeni novci v obtoku šele po letu 425, zaradi pomanjkanja denarja v obtoku.<sup>17</sup> Na zahodu imperija so polovičeni novci prav tako prisotni šele v drugem desetletju 5. stoletja.<sup>18</sup> Polovičeni novci druge polovice 4. stoletja s Tonovcovega gradu tako izpričujejo njihovo uporabo šele v prvi polovici 5. stoletja.

23 novcev iz kovnega obdobja 388–403 kaže strukturo, ki jo prikazuje *tabela 5.6*.

Vsi novci tega kovnega obdobja so tipa *Salus Reipublicae*, razen novca Eudoksije. V primeru 72 % novcev ni bilo mogoče opredeliti njihove kovnice, kar je običajen pojav,<sup>19</sup> ostali novci (27 %) pa so iz najdišču najbližje kovnice Aquileia (kat. št. 85, 105–108, 126), kjer so novce tega tipa kovali do leta 402. 38 % teh novcev z najdišča je bilo kovanih po letu 393, ko postane Honorij Avgust (kat. št. 105–108, 115–118), kar je značilnost najdišč, kjer je mogoče denarni obtok dokumentirati še v večjem delu prve polovice 5. stoletja. Pet Honorijevih novcev tega tipa je dobro ohranjenih (kat. št. 105–107, 115, 118), trije pa kažejo sledove izrabe (kat. št. 108, 116, 117), kar govori

*dentum* (Trento): Callegher 1998, 50.

<sup>13</sup> Kot primer za zahodni del rimskega imperija navajamo podatke za Conimbrigo (*Securitas Reipublicae* : *Gloria Romanorum* = 67,3 % : 32,6 %): Pereira, Bost 1974, 286 ss. Podatke za Panonijo podaja Duncan 1993, 79–81.

<sup>14</sup> Asolati, Crisafulli 1999, 53 (Ac).

<sup>15</sup> Callegher 1998, 48.

<sup>16</sup> Gorini 1987, 267–279.

<sup>17</sup> Vasić 1990, 82 ss.

<sup>18</sup> Delmaire 1983, 139.

<sup>19</sup> Prim. zakladno najdbo iz Augsburga, kjer v primeru 69 % novcev tega tipa ni bilo mogoče opredeliti kovnice (Kos 2006, 98).

that were minted in this period (*Securitas Reipublicae* : *Gloria Romanorum* = 26.6 % : 73.3 %) differs from the values most commonly documented across the Empire. Most commonly coins of type *Securitas Reipublicae*<sup>13</sup> dominate, and such an image is also shown by the hoard from Altino in the Venetian territories (the latest coins can be dated to between 410 and 467), in which coins of the type *Securitas Reipublicae* dominate with 85 %.<sup>14</sup> Amongst the individual coin finds in Trento (*Tridentum*), coins of the *Securitas Reipublicae* type are predominant with 70.4 %.<sup>15</sup> A similar ratio of coins as at Tonovcov grad was documented in the hoard found at Alte Ceccato (Vicenza), in which the latest can be dated to the period between 394 and 403 (*Securitas Reipublicae* : *Gloria Romanorum* = 40,9 % : 59,1 %).<sup>16</sup>

Three coins from the mid 4<sup>th</sup> century (Cat. Nos. 33, 70, 77) are halved, i.e. deliberately cut into two. This was a common phenomenon in periods in which there was a lack of change. In the Eastern Empire halved coins are often found in hoards dating to the 5<sup>th</sup> and beginning of the 6<sup>th</sup> centuries. As halved coins were not to be found in hoards buried prior to 423, M. Vasić assumed that halved coins were in circulation only after 425, and that this occurred due to the lack of money in circulation.<sup>17</sup> In the Western Empire, halved coins are only present in the second decade of the 5<sup>th</sup> century.<sup>18</sup> Halved coins from the second half of the 4<sup>th</sup> century from Tonovcov grad thus indicate their use as late as the first half of the 5<sup>th</sup> century.

23 coins from the 388–403 period show the structure on *table 5.6*.

All coins – except for the single coin of Eudoxia – from this minting period were of the type *Salus Reipublicae*. The mint for 72 % of all coins could not be established, which is a normal occurrence.<sup>19</sup> The remaining coins (27 %) are from Aquileia, which was the mint closest to the site (Cat. Nos. 85, 105–108, 126), and where these coins were minted until 402. 38 % of these coins found at the site were minted post 393, when Honorius became Augustus (Cat. Nos. 105–108, 115–118), which is a characteristic of sites where the monetary circulation can be documented throughout most of the first half of the 5<sup>th</sup> century. Five coins of Honorius are well preserved (Cat. Nos. 105–107, 115, 118), and three are rather worn (Cat. Nos. 108, 116, 117), which indicates that they were in circulation for a longer period of time.

<sup>13</sup> As an example for the Western Roman Empire, we present the data for Conimbriga (*Securitas Reipublicae* : *Gloria Romanorum* = 67.3 % : 32.6 %): Pereira, Bost 1974, 286 ff. The data for Pannonia is provided by Duncan 1993, 79–81.

<sup>14</sup> Asolati, Crisafulli 1999, 53 (Ac).

<sup>15</sup> Callegher 1998, 48.

<sup>16</sup> Gorini 1987, 267–279.

<sup>17</sup> Vasić 1990, 82 ff.

<sup>18</sup> Delmaire 1983, 139.

<sup>19</sup> Compare to the hoard from Augsburg, where the mint could not be ascertained for 69 % of this type of coins (Kos 2006, 98).

Tab. 5.6: Zastopanost novcev po tipih, kovnicah in vladarjih v kovnem obdobju 388–403.

Tab. 5.6: Coins by types, mints and rulers, in the period 388–403.

Tip / Type	Salus Reipublicae		Gloria Romanorum (tip / type 24)	Skupaj / Total
Kovnica / Mint	Aq	Ned. kovnica / Mint indet.	Ned. kovnica / Mint indet.	
Arcadius	1	4		5 (21,7%)
Eudoxia			1	1 (4,3%)
Honorius	4	4		8 (34,7%)
Arcadius ali / or Honorius		7		7 (30,4%)
Valentinianus II., Theodosius I., Arcadius ali / or Honorius	1	1		2 (8,7%)
Skupaj / Total	6 (27,2%)	16 (72,2%)	1 (4,3%)	23

za njihovo dolgotrajnejšo uporabo oziroma prisotnost v obtoku še dolgo po njihovem kovanju in predaji v obtok.

Z 32 % (20 primerkov) so med novci druge polovice 4. in prve polovice 5. stoletja najmočnejše zastopani rimski novci najmlajšega na najdišču zastopanega kovnega obdobja 408–423. To so bronasti novci tipa Gloria Romanorum 11, kovani v času samostojne vlade cesarja Honorija (kat. št. 91–104, 109–114). Pet novcev je zelo lepo ohranjenih (93, 94, 100, 109, 110), deset novcev je dobro ohranjenih (91, 92, 96–99, 101, 104, 112, 114), pet novcev pa je izrabljenih (kat. št. 95, 102, 103, 111, 113). Glede na dolgotrajno kovanje novcev tega tipa (15 let) ni mogoče ugotoviti, kdaj naj bi prišli na najdišče oziroma v uporabo, niti ni mogoče podrobneje opredeliti, do kdaj bi te novce lahko še uporabljali. Verjetna je domneva, da bi vsaj izrabljeni novci lahko bili v obtoku še v četrtem desetletju 5. stoletja.

Številčna zastopanost novcev obdobja 408–423, ki prav po intenzivnosti odstopa od primerljivih raziskanih višinskih naselbin na širšem območju,<sup>20</sup> odraža intenzivno poselitev in uporabo denarja na naselbini v sredini prve polovice 5. stoletja.<sup>21</sup> Analiza novčnih najdb s področja današnje Slovenije kaže, da so v prvi polovici 5. stoletja v zahodnem delu Slovenije v obtoku prevladovali prav bronasti Honorijevi novci tipa Gloria Romanorum 11.<sup>22</sup>

Podobna struktura denarnega obtoka rimskega obdobja kot na Tonovcovem gradu je dokumentirana v Concordiji (Quartiere Nord Ovest), kjer je bilo med leti 1982–1988 izkopanih 124 novcev,<sup>23</sup> med katerimi so

With a 32 % share (20 examples), the best represented coins from the second half of the 4<sup>th</sup> and first half of the 5<sup>th</sup> century at Tonovcov grad are the Roman coins from the latest minting period (408–423). These are bronze coins of the type Gloria Romanorum 11, minted during the independent reign of Emperor Honorius (Cat. Nos. 91–104, 109–114). Five coins are extremely well preserved (93, 94, 100, 109, 110), ten coins are in a good condition (91, 92, 96–99, 101, 104, 112, 114), while five coins are in a poor condition (Cat. Nos. 95, 102, 103, 111, 113). Taking into account the long period during which this type was minted (15 years), it is impossible to ascertain when they arrived at the site or were placed in circulation, nor can it be more precisely determined until when these coins were still in use. It is possible that all of the poorly preserved coins could have been in use as late as the fourth decade of the 5<sup>th</sup> century.

The volume of coins dating to the period between 408 and 423 (which stands out from the comparable investigated elevated settlements in the broader area)<sup>20</sup> indicates that this was an intensively inhabited settlement and that these coins were in use in the middle of the first half of the 5<sup>th</sup> century.<sup>21</sup> The analysis of the coin finds from the territory of present day Slovenia shows that in the first half of the 5<sup>th</sup> century, bronze coins of Honorius of the type Gloria Romanorum 11 dominated in western Slovenia.<sup>22</sup>

A similar structure of monetary circulation during the Roman period (as at Tonovcov grad) has been documented in Concordia (Quartiere Nord Ovest), where

<sup>20</sup> S Honorijevim novcem tipa Gloria Romanorum 11 zaključuje tudi redni denarni obtok na Colle Santino v Invillinu, kjer je bilo v celoti sicer dokumentiranih le skromnih 39 novcev: Bierbrauer 1987, 411–413. Glej tudi Kos 1986, 208–217.

<sup>21</sup> Kos 2000, 107–118.

<sup>22</sup> Kos 2000, 111. Glej še Miškec 2007, 279. Po Callegher, Passera, Saccocci 2007, 254 je ta tip novcev osredinjen na pokrajini Veneto in Furlanija ter Istro.

<sup>23</sup> Bonomi 1988, 165–168; Arzone 1988, 190–199; Arzone 1989, 135–140.

<sup>20</sup> The regular money circulation at Colle Santino in Invillino also ended with a coin of Honorius of the type Gloria Romanorum 11. At this site a total of merely 39 coins were documented: Bierbrauer 1987, 411–413. See also Kos 1986, 208–217.

<sup>21</sup> Kos 2000, 107–118.

<sup>22</sup> Kos 2000, 111. See also Miškec 2007, 279. According to Callegher, Passera, Saccocci 2007, 254, the coins of this type are concentrated in the plain of Veneto and Friuli as well as in Istria.

najmlajši najdeni novci Honorijeve bronasti novci tipa Gloria Romanorum 11. Sporadične novčne najdbe iz poznorimske utrjene naselbine Castellazzo pri Doberdodu kažejo, da so bili tudi tu najmlajši novci v obtoku Honorijeve bronasti novci tipa Gloria Romanorum 11.<sup>24</sup> Če upoštevamo vse antične novce, pa Tonovcovemu gradu najbolj podobno strukturo kaže 86 novcev, izkopanih v Veroni, kjer so najmlajši med poznorimskimi bronastimi novci prav novci tipa Gloria Romanorum 11, poleg tega pa so na najdišču dokumentirani še bronasti novci Zenona iz konca 5. stoletja ter dva bronasta vzhodnogotska novca iz obdobja 512–522.<sup>25</sup> Tudi na Colle Santino v Invillinu je bil – podobno kot na Tonovcovem gradu – odkrit Zenonov tremis milanske kovnice iz obdobja 480–491.<sup>26</sup>

Na Tonovcovem gradu niso bili dokumentirani bronasti novci Honorijeve naslednikov Teodozija II. ali Valentinijana III., ki so bili v vsakodnevni uporabi v severni Italiji.<sup>27</sup> G. Gorini je pred časom sicer domneval, da se denarni obtok v Benečiji zaključuje z emisijami novcev iz obdobja 388–402,<sup>28</sup> za Akvilejo pa je Gorini navajal zgolj sumarne podatke, iz katerih izhaja, da so bili najmlajši bronasti novci kovani v obdobju 388–410.<sup>29</sup> Tudi sicer navaja Gorini zmanjšanje proizvodnje bronaste denarja v obdobju med 408 in vlado Valentinijana III. (425–455).<sup>30</sup> V Trentu (*Tridentum*) so bili v obtoku še novci, ki so bili kovani po letu 423.<sup>31</sup> Novci iz obdobja 423–455 so bili zastopani tudi v veliki raztreseni novčni depojski najdbi s področja utrjene naselbine Castellazzo pri Doberdodu.<sup>32</sup> Gorini postavlja zakop te zakladne najdbe v čas med 450 in 460,<sup>33</sup> njen sestav pa tako jasno odraža strukturo denarja, ki je bil na tem prostoru do tega časa v vsakodnevnem obtoku.

Struktura denarnega obtoka na naselbini Tonovcov grad potemtakem povsem ustreza strukturi denarnega obtoka zelo poznih rimskih poselitvenih središč v severovzhodni Italiji. *Preglednica 5.7* kaže primerjavo zastopanosti poznorimskih novcev posameznih kovnih obdobji na Tonovcovem gradu s tremi tipičnimi najdišči (upoštevani so le določljivi novci).

Na osnovi primerjalnih podatkov je mogoče z veliko gotovostjo trditi, da je reden dotok denarja na

124 coins were excavated between 1982 and 1988.<sup>23</sup> The latest coins are bronze coins of Honorius of the Gloria Romanorum 11 type. Sporadic coin finds from the Late Roman fortified settlement of Castellazzo near Doberdod also show that the latest coins in circulation were bronze coins of Honorius of the type Gloria Romanorum 11.<sup>24</sup> If we take into account all coins from antiquity, the structure closest to Tonovcov grad is shown by the 86 coins excavated at Verona, where the latest amongst the Late Roman bronze coins were Gloria Romanorum 11 coins, accompanied by a bronze coin of Zeno from the end of the 5<sup>th</sup> century and two bronze coins of the Ostrogoths from between 512 and 522.<sup>25</sup> Similarly as at Tonovcov grad, a tremissis of Zeno from the Milan mint (dated between 480 and 491)<sup>26</sup> was discovered at Colle Santino in Invillino.

No bronze coins of Honorius' successors, Theodosius II and Valentinian III, were documented at Tonovcov grad, even though they were in everyday use in northern Italy.<sup>27</sup> At one point G. Gorini assumed that the monetary circulation in Venetian lands ended with the emissions of coins dating to the period between 388 and 402,<sup>28</sup> and for Aquileia he stated merely summary data from which it can be concluded that the latest bronze coins were minted between 388 and 410.<sup>29</sup> Gorini also mentioned a decline in the production of bronze coins between 408 and the reign of Valentinian III (425–455).<sup>30</sup> At Tridentum they still used coins that were minted post 423.<sup>31</sup> Coins from between 423 and 455 were also discovered in the large scattered coin hoard in the fortified settlement of Castellazzo near Doberdod.<sup>32</sup> Gorini placed the burial of this hoard between 450 and 460,<sup>33</sup> and its composition clearly reflects the structure of the coins that were in everyday circulation in this area up to this period.

The structure of the coins in circulation at the settlement of Tonovcov grad thus fits the structure of the coins in circulation in Late Roman centres in north-eastern Italy. *Table 5.7* shows the comparison between the shares of late Roman coins from individual minting periods at Tonovcov grad and three typical sites (only the coins that could be determined were taken into account).

<sup>23</sup> Bonomi 1988, 165–168; Arzone 1988, 190–199; Arzone 1989, 135–140.

<sup>24</sup> Ahumada Silva 1989, 84–85.

<sup>25</sup> Arzena 1987, 123–135.

<sup>26</sup> The coin was wrongfully identified as an Ostrogothic coin dating to 474–476; Bierbrauer 1987, 413 Cat. No. 39, Pl. 69, 2.

<sup>27</sup> Cf. *Opitergium*: Callegher 1992, 12/7 104–105; 14 648–649. Altino: Asolati, Crisafulli 1999, 53 (Ad) 1586–1587, 1614–1616, 1618–1622. Quarto d'Altino: Asolati, Crisafulli 1999 1(9) 172–173.

<sup>28</sup> Gorini 1987, 275.

<sup>29</sup> Gorini 1979, 435. See also Reece 1971, 171.

<sup>30</sup> Gorini 1996, 187.

<sup>31</sup> Callegher 1998, 76–78, 263 ff., 308.

<sup>32</sup> Ahumada Silva 1989, 45–53.

<sup>33</sup> Gorini 1989, 42.

<sup>24</sup> Ahumada Silva 1989, 84–85.

<sup>25</sup> Arzena 1987, 123–135.

<sup>26</sup> Novci je sicer napačno določen kot vzhodnogotski (za Zenona) iz časa 474–476; Bierbrauer 1987, 413 kat. št. 39, Taf. 69, 2.

<sup>27</sup> *Prim. Opitergium*: Callegher 1992, 12/7 104–105; 14 648–649. Altino: Asolati, Crisafulli 1999, 53 (Ad) 1586–1587, 1614–1616, 1618–1622. Quarto d'Altino: Asolati, Crisafulli 1999 1(9) 172–173.

<sup>28</sup> Gorini 1987, 275.

<sup>29</sup> Gorini 1979, 435. Glej tudi podatke pri Reece 1971, 171.

<sup>30</sup> Gorini 1996, 187.

<sup>31</sup> Callegher 1998, 76–78, 263 ss, 308.

<sup>32</sup> Ahumada Silva 1989, 45–53.

<sup>33</sup> Gorini 1989, 42.

Tab. 5.7: Zastopanost novcev posameznih kovnih obdobij druge polovice 4. in prve polovice 5. stoletja na Tonovcovem gradu ter primerjalnih najdiščih.

Tab. 5.7: Shares of coins from individual minting periods in the second half of the 4<sup>th</sup> and the first half of the 5<sup>th</sup> centuries at Tonovcov grad and comparable sites.

Obdobje kovanja / Minting period	Tonovcov grad	Concordia	Castellazzo (zakladna najdba / hoard)	Castellazzo (sporadične najdbe / sporadic finds)	Trento
364–378	15 (24,2%)	8 (17%)	5 (1,3%)	2 (11,7%)	138 (15,1%)
378–383	3 (4,8%)	1 (2,1%)			
364–392			2 (0,5%)		
375–388	1 (1,6%)				
383–403		17 (36,2%)	129 (33,7%)		186 (20,4%)
388–403	13 (20,9%)	18 (38,3%)	6 (1,6%)	1 (5,9%)	573 (62,8%)
393–403	4 (6,4%)		30 (7,8%)		
395–403	6 (9,7%)		9 (2,7%)		
397–428			1 (0,3%)		
404–406					1 (0,1%)
408–423	20 (32,2%)	2 (4,2%)	125 (32,7%)	14 (82,3%)	2 (0,2%)
423–425			48 (12,5%)		1 (0,1%)
425–455		1 (2,1%)	27 (7%)		6 (0,6%)
404–435					2 (0,2%)
457–461					3 (0,3%)
Skupaj / Total	62	47	382	17	912

Tonovcov grad prisoten od valentinijanskega obdobja, torej precej pred pričetkom stalnega dotoka denarja na poznorimsko utrdbo Castellazzo, kjer se intenziven denarni obtok pričinja šele z bronastimi novci tipa *Salus Reipublicae*, torej po letu 388.

Po drugi strani lahko iz primerjalnih podatkov s širšega območja dokaj zanesljivo sklepamo, da je na Tonovcovem gradu reden dotok denarja v obtok prenehal proti koncu tretjega oziroma v četrtem desetletju 5. stoletja. Za to govori odsotnost bronastih novcev Honorijevih naslednikov italskih kovnic, saj je od najdišča zgolj 90 km južneje ležeča kovnica Akvileja (sicer v skromnem obsegu) delovala še v času cesarja Valentinijana III., medtem ko je bilo intenzivno kovanje v tem času v rimski kovnici.<sup>34</sup> Prekinitev dotoka svežega denarja v obtok zato ne moremo interpretirati drugače kot posledico prenehanja intenzivne poselitve. Na osnovi analize novčnih najdb bi potemtakem na Tonovcovem gradu lahko utemeljeno domnevali intenzivno in neprekinjeno poselitev od osmega desetletja 4. stoletja do tretjega ali četrtega desetletja 5. stoletja.

On the basis of analogous results, it can be stated with great certainty that a regular influx of money was present at Tonovcov grad from as early as the reign of Valentinian onwards, i.e. much prior to the start of a constant influx of coins into the Late Roman fortification of Castellazzo, where a more intense circulation began only with the bronze coins of type *Salus Reipublicae* (post 388).

On the other hand, we can use the comparable data from the broader area to state (with a certain degree of certainty) that the regular influx of money into circulation at Tonovcov grad ceased towards the end of the third or in the fourth decade of the 5<sup>th</sup> century. This is shown by the lack of bronze Italian coins of Honorius' successors, for the Aquileia mint was located only 90 km to the south of the site and it still operated (albeit modestly) during the reign of emperor Valentinian III, while intense minting took place at the mint in Rome.<sup>34</sup> The end of the influx of fresh money into circulation can thus not be interpreted in any other way than as a consequence of the end of intense settlement at the site. On the basis of the analysis of coin finds, it can be assumed that Tonovcov grad was intensively and uninterruptedly settled between the eighth decade of the 4<sup>th</sup> century and the third or fourth decade of the 5<sup>th</sup> century.

<sup>34</sup> Kent 1994, 172.

<sup>34</sup> Kent 1994, 172.

5.2.2 VZHODNOGOTSKI  
IN BIZANTINSKI NOVCI

Sledi obdobje, ko v naselbini ni bilo odkritih novcev, ki bi bili kovani v naslednjih petih desetletjih, kar je po vsej verjetnosti posledica opustitve stalne poselitve naselja. Omenjeno cezuro zaključuje najdba Zenovega tremisa milanske kovnice iz let 480–491 (kat. št. 128). Iz obdobja 492–534 je na naselbini dokumentiranih pet vzhodnogotskih novcev (sl. 5.1: 2–7). Tri četrtsilikve ter en bronasti novc v vrednosti 40 numov so bili kovani v imenu vzhodnogotskega vladarja Teoderika (kat. št. 158–161; sl. 5.1: 3–6), polysilikva pa v imenu njegovega naslednika Atalarika (kat. št. 162; sl. 5.1: 7). Tremis Zenona ter vsi vzhodnogotski novci so odlično ohranjeni, kar kaže na njihovo kratkotrajno uporabo. Te novčne najdbe kažejo na ponovno stalno poselitev vzpetine ter potrjujejo prisotnost vzhodnogotskega prebivalstva v naselbini v času od konca 5. stoletja.<sup>35</sup>

Zelo lepo ohranjena Justinijanova četrtsilikva iz 540–552 (kat. št. 157; sl. 5.1: 2), ki je bila kovana v najdišču najbližji kovnici Ravenna, morda govori o (vsaj občasni) poseljenosti prostora še v sredini 6. stoletja.

5.2.2 OSTROGOTHIC  
AND BYZANTINE COINS

No coins minted in the following five decades were found, which is most likely a result of the settlement no longer being permanently inhabited. This hiatus ends with the find of a tremissis of Zeno from the Milan mint, dating to between 480 and 491 (Cat. No. 128). Five Ostrogothic coins dating from 492 to 534 were documented at the settlement. Three quarter-siliquae and one bronze coin valued at 40 nummi were minted in the name of the Ostrogothic ruler *Theodoric* (Cat. Nos. 158-161; Fig. 5.1: 3-6), while a half-siliqua coin was minted in the name of his successor Athalaric (Cat. No. 162; Fig. 5.1: 7). The tremissis of Zeno and all Ostrogothic coins are excellently preserved, which indicates that they were used for a very short period of time. These coin finds show that the site was permanently settled once again and also indicate the presence of Ostrogoths from the end of the 5<sup>th</sup> century onwards.<sup>35</sup>

A very well preserved quarter siliqua of Justinian from between 540 and 552 (Cat. No. 157; Fig. 5.1: 2), minted in Ravenna (the mint closest to the site), could indicate that the area was inhabited (at least occasionally) as late as the mid 6<sup>th</sup> century.



Sl. 5.1: Novci. 1 – kat. št. 96, 2 – kat. št. 157, 3 – kat. št. 158, 4 – kat. št. 159, 5 – kat. št. 160, 6 – kat. št. 161, 7 – kat. št. 162.

Fig. 5.1: Conis. 1 – Cat. No. 96, 2 – Cat. No. 157, 3 – Cat. No. 158, 4 – Cat. No. 159, 5 – Cat. No. 160, 6 – Cat. No. 161, 7 – Cat. No. 162.

<sup>35</sup> Za prisotnost vzhodnogotskih novcev na ozemlju današnje Slovenije glej Kos 2000, 116. Glej še Demo 1994.

<sup>35</sup> For the presence of Ostrogothic coins in the territory of present day Slovenia see Kos 2000, 116. See also Demo 1994.

## 5.3 LITERATURA / BIBLIOGRAPHY

- AHUMADA SILVA, I. 1989, Monete. – V / In: E. Montagnari Kokelj (ur. / ed.), *Il Carso goriziano tra protostoria e storia da Castellazzo a San Polo*, Gorizia, 45–53.
- ARZENA, A. 1987, Verona: monete provenienti dallo scavo archeologico del fabbricato del Monte dei Pegni. – *Quaderni di Archeologia del Veneto* 3, 123–135.
- ARZONE, A. 1988, Le monete. – *Quaderni di Archeologia del Veneto* 4, 190–199.
- ARZONE, A. 1989, Le monete. – *Quaderni di Archeologia del Veneto* 5, 135–140.
- ASOLATI, M. in / and C. CRISAFULLI 1999, *Ritrovamenti monetali di età romana nel Veneto. Provincia VI: Venezia, Vol. I: Altino I.* – Padova.
- BIERBRAUER, V. 1987, *Invillino-Ibligo in Friaul.* – Münchner Beiträge zur Vor- und Frühgeschichte; Bd. 33.
- BONOMI, S. 1988, Le monete. – *Quaderni di Archeologia del Veneto* 4, 165–168.
- CALLEGHER, B. 1992, *Ritrovamenti monetali di età romana nel Veneto (=RMRVe), Provincia II: Treviso, Vol. 2: Oderzo.* – Padova.
- CALLEGHER, B. 1998, Trento-teatro sociale: scavi 1990–1992. Le monete repubblicane, imperiali e medievali: analisi critica e catalogo del complesso numismatico. – V / In: *Materiali per la storia urbana di Tridentum. 2. Ritrovamenti monetali. Archeologia delle Alpi* 4.
- CALLEGHER, B., L. PASSERA in / and A. SACCOCCI 2007, Limiti e potenzialità degli studi sulla circolazione monetaria in ambito locale: il caso delle Valli del Natisone. Saccocci 2007. – V / In: M. Chiabà, P. Maggi, C. Magrini (ur. / ed.), *Le Valli del Natisone e dell'Isonzo tra Centroeuropa e Adriatico. Studi e ricerche sulla Galia Cisalpina* 20. – Roma, 247–265.
- DELMAIRE, R. 1983, Un trésor d'Aes 4 au Musée de Boulogne-sur-mer (notes sur la circulation monétaire en Gaule du nord au début du Ve siècle). – *Trésors monétaires* 5, 131–185.
- DELAMARE, F. 1994, *Le frai et ses lois ou de l'évolution des espèces* (circulation et usure des monnaies). – Paris.
- DEMO, Ž. 1994, *Ostrogothic Coinage from Collections in Croatia, Slovenia and Bosnia & Herzegovina.* – Situla 32.
- DEPEYROT, G. 1999, *Zilil I: étude du numéraire: recherches Archéologiques franco-marocaines à Dchar Jdid, Colonia Iulia Constantia Zilil.* – Roma.
- DUNCAN, G. L. 1993, *Coin circulation in the Danubian and Balkan Provinces of the Roman Empire: AD 294–578.* – London.
- FMRSI I: P. Kos, *Die Fundmünzen der römischen Zeit in Slowenien, Teil I.* – Berlin 1988.
- FMRSI III: P. Kos, A. Šemrov, *Die Fundmünzen der römischen Zeit in Slowenien, Teil III.* – Mainz 1995.
- FMRSI IV: A. Šemrov, *Die Fundmünzen der römischen Zeit in Slowenien, Teil IV.* – Mainz 1998.
- FMRSI V: A. Šemrov, *Die Fundmünzen der römischen Zeit in Slowenien, Teil V.* – Mainz 2004.
- GORINI, G. 1979, Aspetti della circolazione monetaria ad Aquileia e nell' Suo territorio in età antica. – *Antichità Altoadriatiche* 15, 413–437.
- GORINI, G. 1987, Il ripostiglio di Alte Ceccato (Vicenza) e la Circolazione di moneta di bronzo del tardo IV secolo nella Venetia. – V / In: H. Huvelin, M. Christol, G. Gautier (ur. / eds.), *Mélanges de numismatique offerts à Pierre Bastien à l'occasion de son 75<sup>e</sup> anniversaire*, Wetteren, 267–279.
- GORINI, G. 1989, Le monete. – V / In: E. Montagnari Kokelj (ur. / ed.), *Il Carso goriziano tra protostoria e storia da Castellazzo a San Polo*, Gorizia, 42–44.
- GORINI, G. 1996, Currency in Italy in the fifth century A.D. – V / In: C. King, D. Wigg (ur. / eds.), *Coin Finds and Coin Use in the Roman World: a NATO advanced research workshop. Studien zu Fundmünzen der Antike* 10. Berlin, 185–202.
- KENT, J. P. C. 1994, *Roman Imperial Coinage, Vol. X. The Divided Empire and the Fall of the Western Empire 395–491.* – London.
- KOS, P. 1986, *The Monetary Circulation in the South-eastern Alpine Region ca. 300 BC – AD 1000.* – Situla 24.
- KOS, P. 2000, The numismatic evidence for the period from the 5<sup>th</sup> to the 10<sup>th</sup> centuries in the area of modern Slovenia. – V / In: R. Bratož (ur. / ed.), *Slovenija in sosednje dežele med antiko in karolinško dobo / Slowenien und die Nachbarländer zwischen Antike und karolingischer Epoche.* – Situla 39, 107–118.
- KOS, P. 2006, Der theodosianische Aes 4-Beutelfund aus Augsburg. – *Bayerische Vorgeschichtsblätter* 71, 95–114.
- MIŠKEC, A. 2007, Monetary circulation in the Posočje Region in the Antiquity. – V / In: M. Chiabà, P. Maggi, C. Magrini (ur. / eds.), *Le Valli del Natisone e dell'Isonzo tra Centroeuropa e Adriatico. Studi e ricerche sulla Galia Cisalpina* 20. Roma, 275–281.
- PEREIRA, I., J.-P. BOST, in / and J. HIERNARD 1974, *Fouilles de Conimbriga. 3, Les monnaies.* – Paris.
- REECE, R. 1971, Roman coinage in northern Italy. – *Numismatic Chronicle* 11, 167–179.
- REECE, R. 1982, A collection of coins from the centre of Rome. – *Papers Brit. School Rome* 50, 116–145 (= Reece 2003, 192–213).
- REECE, R. 2003, *Roman Coins and Archaeology. Collected Papers.* – Wetteren 2003.
- VASIĆ, M. 1990, *Horreum Margi. Nalazi rimskog bronzanog novca IV i V veka iz municipijuma Horreum Margi / Trouvaille des monnaies de bronze de IV<sup>ème</sup> et V<sup>ème</sup> siècle en municipe Horreum Margi.* – Beograd.

## 6. PRAZGODOVINSKE NAJDBE S TONOVCOVEGA GRADU IN ŽELEZNODOBNA KULTNA MESTA V POSOČJU

### 6. PREHISTORIC FINDS FROM TONOVCOV GRAD AND IRON AGE CULT PLACES IN THE POSOČJE AREA

Dragan BOŽIČ

(dodatek / appendix: Matija TURK)

#### 6.1 UVOD

Prazgodovinske drobne najdbe s Tonovcovega gradu so v primerjavi s tistimi iz rimske dobe in iz pozne antike maloštevilne. Kamnitih je skupno dvajset in obsegajo orodja, odbitke in eno jedro (*sl. 6.1*). Večinoma izvirajo iz najstarejših poselitvenih plasti na najdišču, ki so vsebovale tudi nekaj zelo skromnih, časovno težko opredeljivih odlomkov keramike. Plasti je mogoče datirati široko, od mlajše kamene do bronaste dobe (Tonovcov grad. Naselbinski ostanki in interpretacija, pogl. 2.2; prim. Milavec, Modrijan 2007, 108 in 110, sl. 3).

Le malo več, devetnajst, je najdb iz železne dobe (*sl. 6.2*). Cele so samo tri, obročka s šestimi izrastki in steklena jagoda s plastovitimi očesci (*sl. 6.2: 2, 4, 7*). Pravokotna ploščica (*sl. 6.2: 14*) je poškodovana, vse drugo pa so odlomki predmetov. Razen treh železnih in ene iz stekla so vse najdbe iz bakrove zlitine, večinoma gotovo iz brona. Trije odlomki fibul vrste Jezerine (*sl. 6.2: 17–19*) bi bili lahko tudi iz medenine ali celo iz rdeče litine, to je zlitine bakra s kositrom in cinkom (Šmit et al. 2005, 229, št. 3 in 232, levi stolpec; Istenič, Šmit 2007, 142, sl. 4, 144–145, Results). Kemijske analize niso bile opravljene.

Skoraj vse železnodobne najdbe so bile odkrite v poznoantičnih ruševinskih plasteh v izkopnem polju stavbe 1 (Tonovcov grad. Naselbinski ostanki in interpretacija, pogl. 3.1; prim. Milavec, Modrijan 2007, 110; Milavec 2008, 9). Tri so našli že pred izkopavanji pri iskanju z detektorjem za kovine (*sl. 6.2: 7, 11, 19 – Ciglenečki 1994, 5, t. 1: 1, 2; 6, t. 2: 6*), vse druge pa med načrtnimi izkopavanji. V poznejših objavah jih je bilo od teh predstavljenih samo nekaj (Ciglenečki 1997, 30–31, druga in tretja vrsta; Milavec, Modrijan 2007, 110–111, sl. 4), vse najdbe razen dveh, ki sta založeni (*sl. 6.2: 7, 19*), pa je v svojo neobjavljeno doktorsko disertacijo zajela Tina Milavec (Milavec 2008, 5, 9, 11, t. 1: 5–16, 21; 2: 1, 5; 4: 16; 12: 5). Slavko Ciglenečki (1997, 7–8) je na podlagi teh najdb sklepal, da je bila tu v starejši in mlajši železni dobi ali opazovalnica ali kulturni prostor ali pa pribežališče prebivalcev slabše zavarovanega Gradiča, ki je od Tonovcovega gradu oddaljen samo 2 km. Milavčeva je opustila misel o

#### 6.1 INTRODUCTION

Prehistoric small finds from Tonovcov grad are scarce in comparison to those from the Roman period and Late Antiquity. Twenty are stone finds and include tools, flakes, and a core (*Fig. 6.1*). They mostly originate from the earliest settlement layer at the site which also contained a few very modest pottery fragments and can be only broadly dated from the Neolithic to the Bronze Age (Tonovcov grad. Settlement remains and interpretation, chapter 2.2; cf. Milavec, Modrijan 2007, 108–109, Fig. 3).

Just a few more, nineteen, finds are from the Iron Age (*Fig. 6.2*). Only three are whole, namely two rings with six knobs and a glass bead with layered eyes (*Fig. 6.2: 2, 4, 7*). The rectangular plate (*Fig. 6.2: 14*) is damaged, while everything else are object fragments. Except for three iron and one glass find, all others are made of copper alloy, mostly certainly from bronze. Three fragments of Jezerine type fibulae (*Fig. 6.2: 17–19*) could also be made of brass or even of gunmetal, an alloy of copper with tin and zinc (Šmit et al. 2005, 217, Tab. 3, 227, left column; Istenič, Šmit 2007, 142, Fig. 4, 144–145, Results). Chemical analyses were not performed.

Almost all Iron Age finds were discovered in the Late Antique destruction layers in the excavation area of building 1 (Tonovcov grad. Settlement remains and interpretation, chapter 3.1; cf. Milavec, Modrijan 2007, 109; Milavec 2008, 9). Three were found prior to the excavations, during the metal detector search (*Fig. 6.2: 7, 11, 19 – Ciglenečki 1994, 5, Pl. 1: 1, 2; 6, Pl. 2: 6*), while all others were discovered during the systematic excavations. In later publications only a few of them were presented (Ciglenečki 1998, 30–31, the second and third row; Milavec, Modrijan 2007, 109, Fig. 4), and all besides two, which are misplaced (*Fig. 6.2: 7, 19*), are included in the unpublished doctoral thesis of Tina Milavec (Milavec 2008, 5, 9, 11, Pls. 1: 5–16, 21; 2: 1, 5; 4: 16; 12: 5). Slavko Ciglenečki (1998, 7–8) inferred on the basis of these finds that in the Early and Late Iron Age a lookout station or a cult place or a refuge for inhabitants of more poorly secured Gradič, which is only 2 km away from Tonovcov

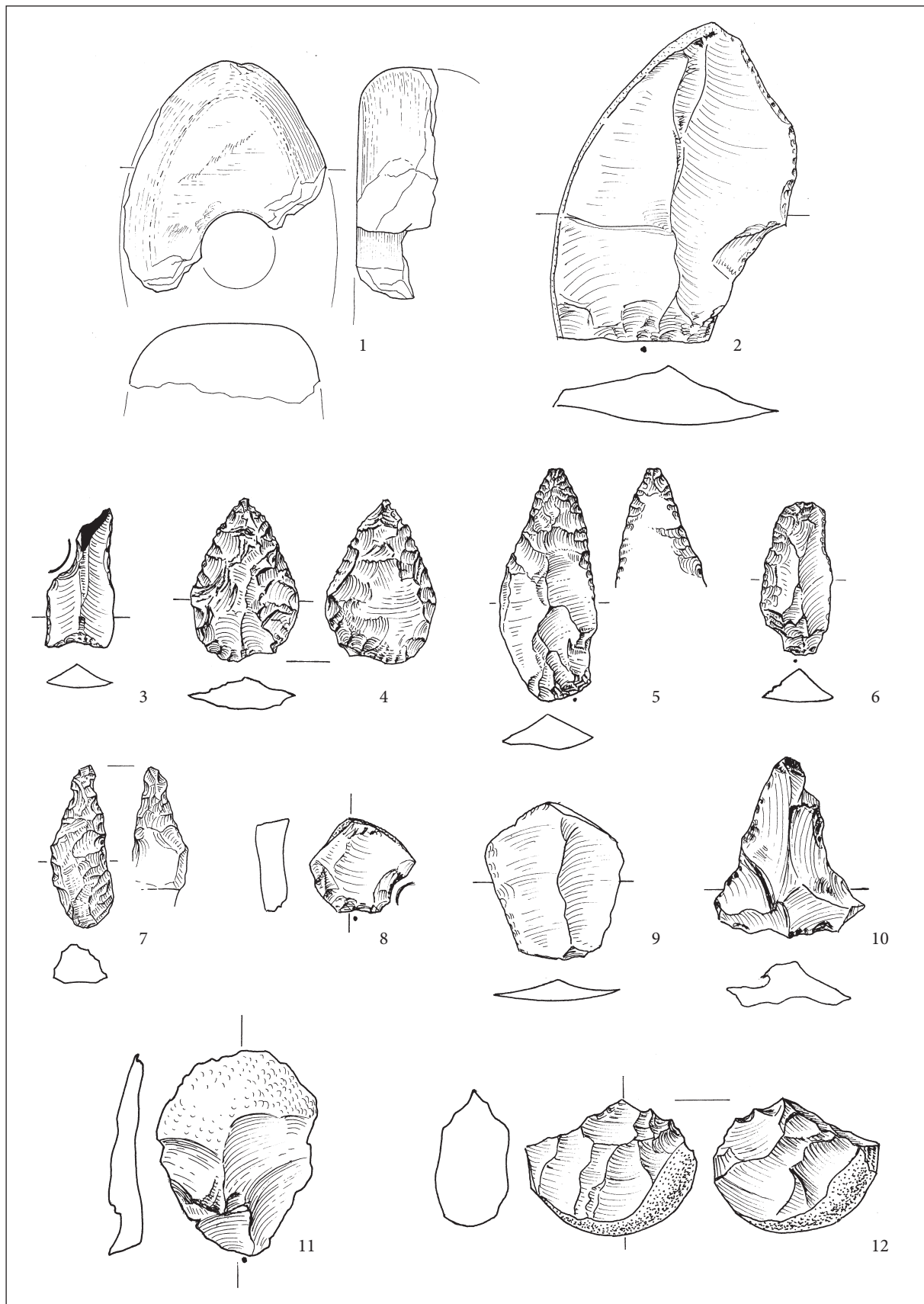

Sl. 6.1: Kamnite najdbe s Tonovcovega gradu pri Kobaridu. M. 1 = 1:2, 2-12 = 1:1.

Fig. 6.1: Stone finds from Tonovcov grad near Kobarid. Scale 1 = 1:2, 2-12 = 1:1.



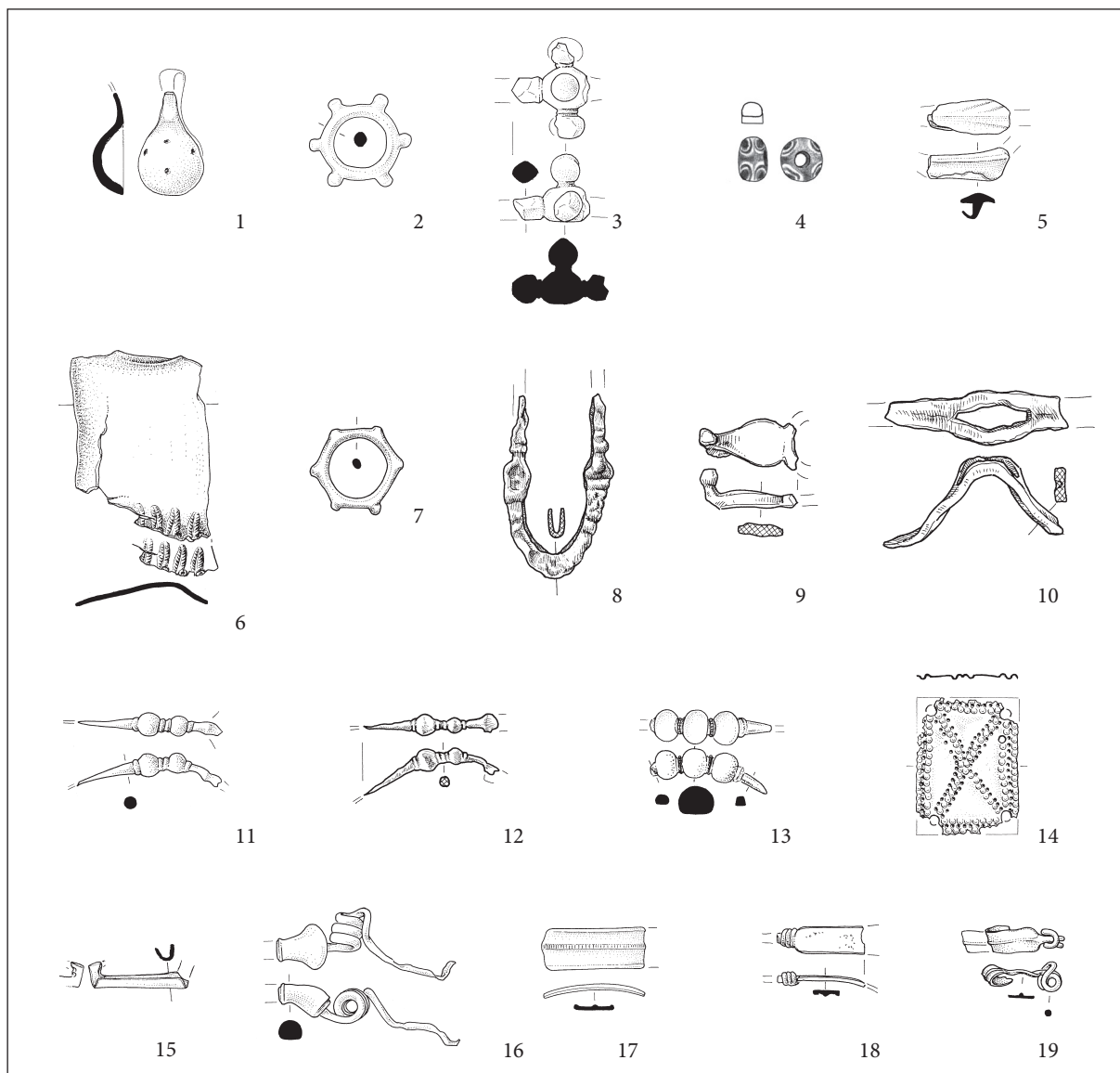

Sl. 6.2: Železnodobne najdbe s Tonovcovega gradu pri Kobaridu. 1–3, 5–7, 11–16 bron, 4 steklo, 8–10 železo, 17–19 bakrova zlitina. M. = 1:2.

Fig. 6.2: Iron Age finds from Tonovcov grad near Kobarid. 1–3, 5–7, 11–16 bronze, 4 glass, 8–10 iron, 17–19 copper alloy. Scale = 1:2.

opazovalnici ali pribežališču. Po njenem mnenju (2008, 5) spekter najdb nakazuje možnost, da je bilo tukaj svetišče, podobno kot na Gradiču nad Kobaridom.

## 6.2 NAJDBE IZ STAREJŠE ŽELEZNE DOBE

Na Tonovcovem gradu je bilo najdenih sedem najdb iz starejše železne dobe: polovica votlega kroglastelega obeska, dva obročka s šestimi izrastki, odlomek trortaste fibule, steklena jagoda, odlomek certoške fibule in odlomek štule negovske čelade (sl. 6.2: 1–7).

grad, were located here. Milavec abandoned the idea of the lookout station or refuge. According to her (2008, 5), the spectrum of finds indicates the possibility that this was a sanctuary, similar to Gradič above Kobarid.

## 6.2 EARLY IRON AGE FINDS

Seven Early Iron Age finds were discovered at Tonovcov grad: one half of a hollow globular pendant, two rings with six knobs, a fragment of a three-knobbed fibula, a glass bead, a fragment of a Certosa fibula, and a fragment of a cap of a Negova helmet (Fig. 6.2: 1–7).

### 6.2.1 VOTEL KROGLAST OBESK VRSTE POSOČJE

Ciglenečki (1997, 7) in Milavčeva (Milavec 2008, 9, op. 19; 149, t. 1: 9) sta s tem, ko sta polovico votlega obeska, sestavljenega iz dveh polkroglastih polovic, ki ju povezuje zanka za obešanje (*sl.* 6.2: 1), imenovala "del oziroma polovica kraguljčka", sledila neustreznemu poimenovanju, ki ga je za take obeske predlagala Biba Teržan (Teržan, Lo Schiavo, Trampuž-Orel 1985, 35, št. 9). Kraguljčki imajo v svoji notranjosti kroglice, ki z udarjanjem ob kovinski plašč ustvarjajo zvok (Štular 2009, 114), obravnavani votli obeski pa kroglic nimajo. Poleg tega imajo pravi kraguljčki reže ali okrogle luknjice ali oboje, pri obravnavanih obeskih pa se votli polovici stikata. Ustrezno poimenovanje "votel kroglast obesek" je uporabil Stane Gabrovec (1974, 303). Zdi se mi najprimernejše, ker izhaja iz tega, da so obeski v obliki kroglice lahko polni ali pa votli tako kot v našem primeru.

Doslej najtemeljitejšo obravnavo so taki obeski, ki se pojavljajo predvsem na najdiščih svetolucijske skupine v Posočju in Bohinju, medtem ko jih dolenska halštatska skupina ne pozna, doživeli v delu Thila Warnekeja o halštatskih in zgodnjelatskih obeskih. Warneke jih je sicer neustrezno uvrstil med kroglaste votle pločevinaste obeske ("kugelige Hohlblechanhänger"), ki so narejeni iz dveh tanjenih polkrogel, povezanih z zanko (Warneke 1999, 31–36, *sl.* 9 in 10). Posoški primerki se od drugih razlikujejo ne samo po masivni izdelavi, ampak tudi po velikosti. Warneke je ugotovil, da so tisti s premerom, večjim od 1,2 cm, najpogostejši v Sloveniji (prav tam, 32). Glede datacije ulitih in velikih obeskov, ki bi jih smeli imenovati "votli kroglasti obeski vrste Posočje", je pravilno sklepal, da sodijo zato, ker so bili skupaj z obeski drugih oblik (npr. s prstani in pincetami) obešeni na svetolucijske ločne fibule (prav tam, Verwendung), v čas uporabe teh fibul, to je v stopnji Sv. Lucija IIa in IIb po Teržanovi in Trampuževi (prav tam, 33, Chronologie, op. 145). Zabeležil je primerke s petih najdišč – z Mosta na Soči, s Koritnice v dolini Bače, z Bitenj in Lepenc v Bohinju ter s Pristave na Bledu (prav tam, 34, Referenzliste, zadnji odstavek).

Premer obeskov vrste Posočje se giblje od 1,4 do 2,2 cm. Večinoma so neokrašeni (*sl.* 6.3: 1–4), nekateri pa so tako kot primerki s Tonovcovega gradu okrašeni s krožci s piko (*sl.* 6.3: 1, 5; 6.4: 1). Vsi primerki, ki jih je zbral Warneke, izvirajo iz grobov. Izjema je le okrašeni obesek s Pristave na Bledu, ki ni bil najden v grobu (Gabrovec 1960, 30, Grob ž 36, št. 6, t. 19: 8; Obeski). Gre za posamezno najdbo, ki je ležala nad kamnito oblogo groba 36.

Warnekejev seznam votlih kroglastih obeskov vrste Posočje lahko razen s primerkom s Tonovcovega gradu dopolnim še s polovičnimi obeski s kulturnih mest Vrh gradu pri Pečinah (*sl.* 6.3: 2 – Božič 1999b, 75, *sl.* 5: 2) in Kovačevše nad Lokavcem (*sl.* 6.3: 3 – Svoboda

### 6.2.1 HOLLOW GLOBULAR PENDANT OF THE POSOČJE TYPE

Ciglenečki (1997, 7) and Milavec (Milavec 2008, 9, note 19; 149, Pl. 1: 9), when they called a half of the hollow pendant which is assembled from two semi-globular halves that are connected by a suspension loop (*Fig.* 6.2: 1), 'a part or one half of a rumbler bell', followed the inappropriate denomination suggested for such pendants by Biba Teržan (Teržan, Lo Schiavo, Trampuž-Orel 1985, 35, no. 9). In their interior, rumbler bells have small balls which produce a sound by striking against the metal coat (Štular 2009, 114), while the discussed hollow pendants do not have such balls. Moreover, the true rumbler bells have slits or circular holes or both, while with the discussed pendants the hollow halves touch. The appropriate denomination of a 'hollow globular pendant' was used by Stane Gabrovec (1974, 303). This seems to me the most appropriate since it derives from the fact that pendants in the form of a small ball can be solid or hollow, as in this case.

Until now the most thorough discussion about such pendants, which appear mostly on the sites of the Sveta Lucija group in the Posočje area and Bohinj, while they are unknown to the Dolenska Hallstatt group, has been presented in the work of Thilo Warneke about the Hallstatt and Early La Tène pendants. Warneke classifies them, inappropriately, among globular hollow sheet pendants ('kugelige Hohlblechanhänger') made of two thinned semi-globes, connected by a loop (Warneke 1999, 31–36, *Figs.* 9 and 10). The Posočje area items differ from others in being larger and in having much thicker walls. Warneke finds that those with diameter greater than 1.2 cm are the most frequent in Slovenia (*ibid.*, 32). Regarding the dating of cast and large pendants, which could be named 'hollow globular pendants of the Posočje type', he correctly concluded that due to the fact that they were together with pendants of other forms (e.g. rings and tweezers) hung on the Sveta Lucija bow fibulae (*ibid.*, Verwendung), they belong to the time when these fibulae were used, i.e. to phases Sveta Lucija IIa and IIb according to Teržan and Trampuž (*ibid.*, 33, Chronologie, note 145). He recorded examples from five sites – Most na Soči, Koritnica in the Bača Valley, Bitnje and Lepence in Bohinj, and Pristava in Bled (*ibid.*, 34, Referenzliste, the last paragraph).

The diameter of the Posočje type pendants ranges from 1.4 to 2.2 cm. They are mostly undecorated (*Fig.* 6.3: 1–4) but some also appear which are just like the item from Tonovcov grad decorated by ring-and-dots (*Figs.* 6.3: 1, 5; 6.4: 1). All items collected by Warneke originate from graves. The only exception is the decorated pendant from Pristava in Bled, which was not found in a grave (Gabrovec 1960, 30, Grob ž 36, no. 6, Pl. 19: 8; Obeski). This is an isolated find which lay above the stone covering of grave 36.

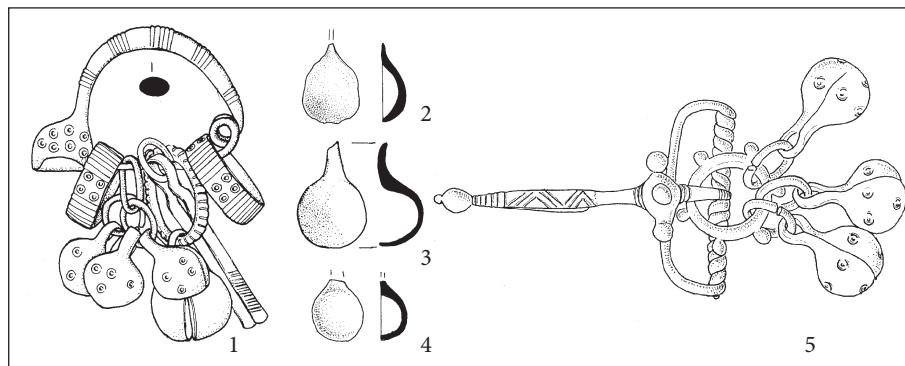

Sl. 6.3: Svetolucijska ločna fibula iz groba Sz 643 na Mostu na Soči z različnimi obeski (1), polovice votlih kroglastih obeskov z Vrh gradu pri Pečinah (2), s Kovačevša nad Lokavcem (3) in z najdišča Sv. Janez v Ribčevem Lazu (4) ter trortasta fibula vrste XI po Ogrinovi iz Mecklenburške zbirke (5). Vse bron. M. = 1:2 (1 Teržan, Lo Schiavo, Trampuž-Orel 1984, t. 57; 2 Božič 1999b, sl. 5; 3 Svöljšak 1983, t. 4; 5 Mahr 1934, t. 15).

Fig. 6.3: Sveta Lucija bow fibula from grave Sz 643 at Most na Soči with various pendants (1), halves of hollow globular pendants from Vrh gradu near Pečine (2), Kovačevše above Lokavec (3), and from the site Sv. Janez in Ribčev Laz (4); and a three-knobbed fibula of type XI according to Ogrin from the Mecklenburg collection (5). All bronze. Scale = 1:2 (1 Teržan, Lo Schiavo, Trampuž-Orel 1984, Pl. 57; 2 Božič 1999b, Fig. 5; 3 Svöljšak 1983, Pl. 4; 5 Mahr 1934, Pl. 15).

1983, 19, št. 12, Polovica bronastega kraguljčka [sic], t. 4: 129) v Posočju in Sv. Janez v Ribčevem Lazu v Bohinju<sup>1</sup> (sl. 6.3: 4) ter z najmanj enim obeskom, odkritim na grobišču pri Dernazzaccu v Nadiških dolinah (Pettarin 2006, 137, Pendenti globulari, t. 26: 448). Maloštevni obeski te vrste iz Notranjske so neokrašeni in so videti masivnejši kot posoški (Guštin 1979, t. 3: 5; 68: 2, 8; Horvat 1995, 180, t. 1: 8).

Trije okrašeni obeski vrste Posočje so obešeni na trortasto fibulo vrste XI po Ogrinovi iz Mecklenburške zbirke (sl. 6.3: 5 – Mahr 1934, 95, lot 78, t. 15: 78). Fibula je bila pripisana grobu 143 grobišča v Stražnem dolu blizu Goleka pri Vinici. Ker se trortaste fibule te vrste, ki se od drugih vrst trortastih fibul loči po samostrelni peresovini, pojavljajo izključno v Posočju in v Nadiških dolinah (Marchesetti 1893, 128, grob 2862, fibula a doppio ardiglione con bottoni, 331, t. 29: 3<sup>2</sup>; Ogrin 1998, 114–115, sl. 19, 127, sl. 36: trikotnik; Pettarin 2006, 91, sl. 23: 1, 203, fibula con bottoni sull'arco, t. 2: 37) in ker imajo podobno razprostranjenost tudi okrašeni obeski vrste Posočje (Posočje, Bohinj, Dernazzacco in Bled), gre v primeru, da je bila fibula res izkopana na Goleku pri Vinici, za predmet, uvožen v Pokolpje s tega območja. Glede na močno pomešanost najdb v Mecklenburški zbirki (Božič 2009; Božič 2010) pa se zdi še verjetneje,

Warneke's list of hollow globular pendants of the Posočje type can, besides the item from Tonovcov grad, be supplemented also by the halves of pendants from the cult places Vrh gradu near Pečine (Fig. 6.3: 2 – Božič 1999b, 75, Fig. 5: 2) and Kovačevše above Lokavec (Fig. 6.3: 3 – Svöljšak 1983, 19, no. 12, One half of the bronze rumbler bell [sic], Pl. 4: 129) in the Posočje area, and Sv. Janez in Ribčev Laz in Bohinj<sup>1</sup> (Fig. 6.3: 4), and also by at least one pendant discovered at the cemetery near Dernazzacco in Valli del Natisone (Pettarin 2006, 137, Pendenti globulari, Pl. 26: 448). Few pendants of this type from the Notranjska region are undecorated and seem even more massive than those from the Posočje area (Guštin 1979, Pls. 3: 5; 68: 2, 8; Horvat 1995, 199, left column, Pl. 1: 8).

Three decorated pendants of the Posočje type are hung on the three-knobbed fibula type XI according to Ogrin from the Mecklenburg collection (Fig. 6.3: 5 – Mahr 1934, 95, lot 78, Pl. 15: 78). The fibula was assigned to grave 143 of the cemetery in Stražni dol near Golek pri Vinici. Since three-knobbed fibulae of this type, which differ from other types of three-knobbed fibulae by the crossbow spring, appear exclusively in the Posočje area and in Valli del Natisone (Marchesetti 1893, 128, grave 2862, fibula a doppio ardiglione con bottoni, 331, Pl. 29: 3<sup>2</sup>; Ogrin 1998, 114–115, Fig. 19, 127, Figs. 36: triangle;

<sup>1</sup> Polovica votlega kroglastega obeska je bila najdena leta 1999 med izkopavanji ob cerkvi, ki jih je vodil Draško Josipovič. Marija Ogrin, direktorica Gorenjskega muzeja v Kranju, mi je ljubeznivo dovolila objavo. Prim. Josipovič, Gaspari, Miškec 2012.

<sup>2</sup> Fibulo, na katero me je opozoril Miha Mlinar iz Tolminskega muzeja v Tolminu, je Ogrinova (1998, 109) uvrstila v vrsto IIa, vendar iz risbe in iz Marchesettijevega opisa izhaja, da je imela samostrelno peresovino.

<sup>1</sup> This half of a hollow globular pendant was found in 1999, during the excavations around the church which were led by Draško Josipovič. Marija Ogrin, the director of Gorenjski muzej in Kranj, kindly allowed me to publish this find. Cf. Josipovič, Gaspari, Miškec 2012.

<sup>2</sup> The fibula, to which my attention was drawn by Miha Mlinar from Tolminski muzej in Tolmin, was assigned by Ogrin 1998, 109 to type IIa, yet it is obvious from the drawing and Marchesetti's description that it had a crossbow spring.

da je vojvodinja Mecklenburška pridobila nekaj železno-dobnih najdb iz Posočja ali Bohinja, ki so bile poznejše napačno pripisane viniškemu grobišču.

Omenil sem že, da je Warneke (1999, 33, op. 145) votle kroglaste obeske vrste Posočje datiral v čas uporabe svetolucijskih ločnih fibul, to je v stopnji Sv. Lucija IIa in IIb. Taka datacija velja za neokrašene obeske. Pregled vsega gradiva iz Posočja in Bohinja pa je pokazal, da lahko okrašene obeske, ki so s polovico enega zastopani tudi na Tonovcovem gradu (*sl.* 6.2: 1), na podlagi grobnih celot oziroma različic svetolucijske ločne fibule, na katerih visijo, datiramo izključno v stopnjo Sv. Lucija IIb. Na tem mestu naj zadošča ugotovitev, da gre za grobove, v katerih se med drugim pojavljajo za to stopnjo značilna mlajša različica svetolucijskih fibul, ki ima lok okrašen z nizi prečnih vrezov ali reber (Parzinger 1988, 14, levi stolpec, Sveta Lucija-III3, t. 12: 174), trakaste fibule z mrežastim okrasom na loku (Teržan, Trampuž 1973, 430, t. 16: 4–9) ter prstani, okrašeni s skupinami prečnih vrezov in z enim ali več krožci s piko med njimi (glej na primer Marchesetti 1893, 24, grob 558, t. 3: 3; 11: 2 [tukaj: *sl.* 6.4]; Gabrovec 1974, t. 4: Grob 11; 6: Grob 14; Teržan, Lo Schiavo, Trampuž-Orel 1984, t. 57: A [tukaj: *sl.* 6.3: 1]; 98; 142: E; 277: 1).

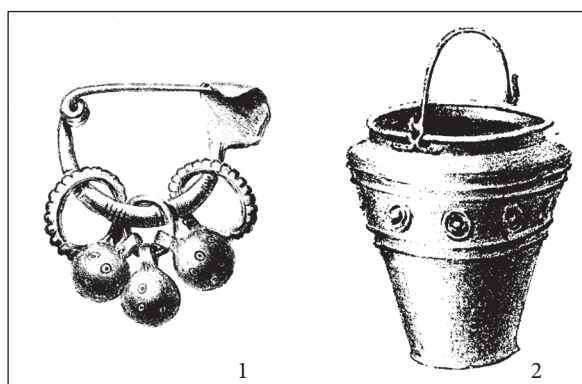

*Sl.* 6.4: Svetolucijska ločna fibula (1) in situla (2) iz groba M 558 na Mostu na Soči. Obe bron. M. 1 = 1:2, 2 = 1:6 (Marchesetti 1893, t. 3 in 11).

*Fig.* 6.4: Sveta Lucija bow fibula (1) and situla (2) from grave M 558 at Most na Soči. Both bronze. Scale 1 = 1:2, 2 = 1:6 (Marchesetti 1893, Pls. 3 and 11).

### 6.2.2 OBROČKA S ŠESTIMI IZRASKTI

Ohranjeni obroček (*sl.* 6.2: 2) ima šest izrazitih izrastkov. Obroček, ki ni ohranjen (*sl.* 6.2: 7), je imel pet neizrazitih izrastkov in enega majhnega.

Bronasti obročki s petimi do sedmimi izrazitimi izrastki, med katerimi prevladujejo taki s šestimi, so pogosti v mladohalštatskih grobovih svetolucijske skupine (Teržan, Lo Schiavo, Trampuž-Orel 1985, 35, št. 16; Warneke 1999, 82, Verbreitung, 83, Referenzliste, sl. 37: 605, 651; Pettarin 2006, 231, pendentii ad anello lobato

37: XI; 132; Pettarin 2006, 91, Fig. 23: 1, 203, fibula con bottoni sull'arco, Pl. 2: 37), and because the similar distribution is revealed also by the decorated pendants of the Posočje type (the Posočje area, Bohinj, Dernazzacco, and Bled) this item was, if the fibula was truly excavated at Golek pri Vinici, imported to Pokolpje (the Kolpa region) from this area. Considering the extensive mixing of finds in the Mecklenburg collection (Božič 2009; Božič 2010) it seems more probable that the duchess of Mecklenburg acquired a few Iron Age finds from the Posočje area or Bohinj and these were later erroneously attributed to the Vinica cemetery.

As mentioned above, Warneke (1999, 33, note 145) assigned hollow globular pendants of the Posočje type to the time when Sveta Lucija bow fibulae were used, i.e. phases Sveta Lucija IIa and IIb. Such dating is valid for undecorated pendants. The survey of all material from the Posočje area and Bohinj revealed, however, that the decorated pendants, which are with one half represented also at Tonovcov grad (*Fig.* 6.2: 1), can on the basis of grave groups and variants of the Sveta Lucija bow fibula, on which they hang, be dated exclusively to phase Sveta Lucija IIb. Here it should suffice to say that these are graves, in which appear for this phase typical later variant of Sveta Lucija fibulae, where the bow is decorated with groups of transversal incisions or ribs (Parzinger 1988, 14, left column, Sveta Lucija-III3, Pl. 12: 174), arc fibulae with lattice decoration on the flat bow (Teržan, Trampuž 1973, 439, Pl. 16: 4–9), and rings decorated by groups of transversal incisions and with one or more ring-and-dots among them (see e.g. Marchesetti 1893, 24, grave 558, Pls. 3: 3; 11: 2 [here: *Fig.* 6.4]; Gabrovec 1974, Pl. 4: Grob 11; 6: Grob 14; Teržan, Lo Schiavo, Trampuž-Orel 1984, Pls. 57: A [here: *Fig.* 6.3: 1]; 98; 142: E; 277: 1).

### 6.2.2 TWO RINGS WITH SIX KNOBS

The preserved ring (*Fig.* 6.2: 2) has six distinct knobs. The ring which is not preserved (*Fig.* 6.2: 7) had five non-distinct knobs and a small one.

Bronze rings with five to seven distinct knobs, among which those with six prevail, are frequent in Late Hallstatt graves of the Sveta Lucija group (Teržan, Lo Schiavo, Trampuž-Orel 1985, 35, no. 16; Warneke 1999, 82, Verbreitung, 83, Referenzliste, Fig. 37: 605, 651; Pettarin 2006, 231, pendentii ad anello lobato a sei lobi). Since the two rings from Tonovcov grad have six knobs each, I will hereon limit my discussion to such rings.

Most of them are known from cemeteries at Most na Soči (e.g. Marchesetti 1893, Pl. 16: 12; Teržan, Lo Schiavo, Trampuž-Orel 1984, Pls. 61: D7; 63: E7; 65: B5 etc.; Mlinar 2002, 45, cat. no. 19; 50, cat. no. 25) and in Bohinj (Gabrovec 1974, Pls. 6: 24;<sup>3</sup> 8: 3, 7; 10: 5–7).

<sup>3</sup> Since the number of knobs on the left ring of the fibula from grave 14 at Bitnje is not clear from the published draw-

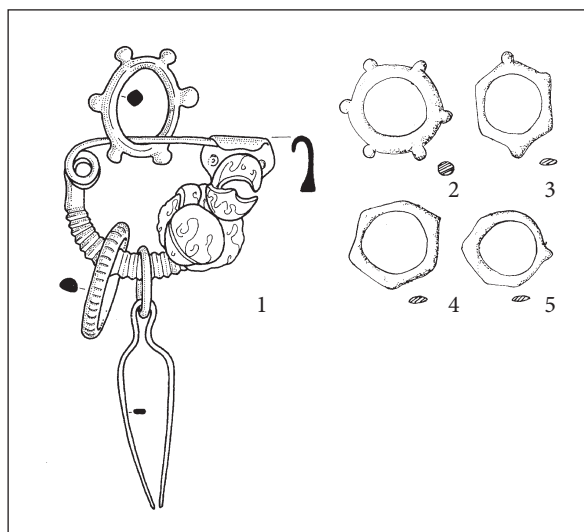

a sei lobi). Ker imata obročka s Tonovcovega gradu po šest izrastkov, se bom v nadaljevanju omejil na take.

Največ jih poznamo z grobišč na Mostu na Soči (npr. Marchesetti 1893, t. 16: 12; Teržan, Lo Schiavo, Trampuž-Orel 1984, t. 61: D7; 63: E7; 65: B5 itd.; Mlinar 2002, 45, kat. št. 19; 50, kat. št. 25) in v Bohinju (Gabrovec 1974, t. 6: 24;<sup>3</sup> 8: 3, 7; 10: 5–7). Eden je bil odkrit tudi v grobu z bronasto situlo s Srpenice v zgornjem Posočju (Mlinar 2004, 139, kat. št. 3, sl. 8: 3; Mlinar 2007, 55, t. 1: 4), eden na najdišču Loga v Bodrežu v srednjem Posočju (Guštin 1991, 12, Bronze, k, t. 40: 17) in eden na Taboru nad Črničami v Vipavski dolini (Osmuk 1988, 213, sl. 22). En obroček, ki je bil najden na grobiščih Dernazzacco ali Špeter Slovenov (it. San Pietro al Natisone), hrani tudi Narodni arheološki muzej v Čedadu (Pettarin 2006, 138, kat. št. 454, t. 26: 454), en cel in vsaj en odlomek pa sta tudi med številnimi najdbami s kulturnega mesta na Medejskem hribu (it. Monte di Medea) nad Medejo (it. Medea) v Furlaniji (sl. 6.5: 2 – Furlani 1974–1975, 36, t. 4: 23, 27).

Izrastki so veliki (npr. Teržan, Lo Schiavo, Trampuž-Orel 1984, t. 61: D7; 65: B5; Gabrovec 1974, t. 8: 7; 10: 5–7) ali majhni (npr. Teržan, Lo Schiavo, Trampuž-Orel 1984, t. 63: E7; 69: A8; Osmuk 1988, 213, sl. 22). Imajo različno obliko, npr. kroglasto (Gabrovec 1974, t. 10: 7), gobasto (Teržan, Lo Schiavo, Trampuž-Orel 1984, t. 116: E2), bikonično (prav tam, t. 65: B5) in pravokotno (prav tam, t. 169: 10). Pogosto jih najdemo skupaj z različnimi drugimi obeski na svetolucijskih ločnih fibulah (npr. Gabrovec 1974, t. 6: 24; 8: 3; Teržan, Lo Schiavo, Trampuž-Orel 1984, t. 69: A8; 116: E2; 216: A1 [tukaj: sl. 6.5: 1]; Mlinar 2002, 45, kat. št. 19), izjemoma tudi

<sup>3</sup> Ker število izrastkov na levem obročku na fibuli iz groba 14 na Bitnjah iz objavljene risbe ni razvidno, si je Peter Turk iz Narodnega muzeja Slovenije to fibulo, ki jo pod inv. št. P 10093 hranijo v njihovi prazgodovinski zbirki, ogledal in mi ljubeznivo sporočil, da imata oba obročka, tako desni masivnejši kot levi manj masivni, po šest izrastkov.

Sl. 6.5: Svetolucijska ločna fibula iz groba Sz 2118 na Mostu na Soči z različnimi obeski (1) in obročki s šestimi izrastki s kulturnega mesta na Medejskem hribu nad Medejo (2–5). Vse bron. M. = 1:2 (1 Teržan, Lo Schiavo, Trampuž-Orel 1984, t. 216; 2–5 Furlani 1974–1975, t. 4).

Fig. 6.5: Sveta Lucija bow fibula from grave Sz 2118 at Most na Soči with various pendants (1) and rings with six knobs from the cult place on Monte di Medea above Medea (2–5). All bronze. Scale = 1:2 (1 Teržan, Lo Schiavo, Trampuž-Orel 1984, Pl. 216; 2–5 Furlani 1974–1975, Pl. 4).

One was discovered also in the grave with the bronze situla from Srpenica in the upper Posočje area (Mlinar 2004, 139, cat. no. 3, Fig. 8: 3; Mlinar 2007, 57, Pl. 1: 4), another at the site Loga at Bodrež in the central Posočje area (Guštin 1991, 12, Bronze, k, Pl. 40: 17), and one at Tabor above Črniče in the Vipava Valley (Osmuk 1988, 213, Fig. 22). One such ring, found at the cemeteries Dernazzacco or San Pietro al Natisone, is kept in the National archaeological museum (Museo Archeologico Nazionale) in Cividale del Friuli (Pettarin 2006, 138, cat. no. 454, Pl. 26: 454), one whole and at least one fragment were found among numerous finds from the cult place on Monte di Medea above Medea in Friuli (Fig. 6.5: 2 – Furlani 1974–1975, 36, Pl. 4: 23, 27).

The knobs are either big (e.g. Teržan, Lo Schiavo, Trampuž-Orel 1984, Pls. 61: D7; 65: B5; Gabrovec 1974, Pls. 8: 7; 10: 5–7) or small (e.g. Teržan, Lo Schiavo, Trampuž-Orel 1984, Pls. 63: E7; 69: A8; Osmuk 1988, 213, Fig. 22). They are of different forms, e.g. globular (Gabrovec 1974, Pl. 10: 7), mushroom-shaped (Teržan, Lo Schiavo, Trampuž-Orel 1984, Pl. 116: E2), biconical (ibid., Pl. 65: B5), and rectangular (ibid., Pl. 169: 10). They are often found together with various other pendants on the Sveta Lucija bow fibulae (e.g. Gabrovec 1974, Pls. 6: 24; 8: 3; Teržan, Lo Schiavo, Trampuž-Orel 1984, Pls. 69: A8; 116: E2; 216: A1 [here: Fig. 6.5: 1]; Mlinar 2002, 45, cat. no. 19), exceptionally also on fibulae of other types (Marchesetti 1893, Pl. 16: 12). As sole pendants these appear also on some Certosa fibulae from the cemetery at Socerb (Mahr 1934, Pl. 30).

They were used in all three Late Hallstatt phases, in phase Sveta Lucija IIa (e.g. Teržan, Lo Schiavo, Trampuž-Orel 1984, Pls. 61: D7; 69: A8), phase IIb (e.g. ibid., Pls. 63: E7; 246: C3; Gabrovec 1974, Pls. 6: 24; 8: 3), and phase IIc (e.g. Teržan, Lo Schiavo, Trampuž-Orel 1984, Pl. 169: 10; Mlinar 2002, 50, cat. no. 25; Mlinar 2004, 137, Fig. 8: 3).

Rings with six non-distinct knobs appear rarely. In the Posočje area, one was discovered at the cemetery Pucarjev rob at Most na Soči (Mlinar 2002, 50, cat.

ing, Peter Turk from the Narodni muzej Slovenije examined anew this fibula, which is under inv. no. P 10093 kept at their prehistoric collection, and kindly reported to me that both rings, the right, more massive one, and the left, less massive, have six knobs each.

na fibulah drugih vrst (Marchesetti 1893, t. 16: 12). Kot edini obeski se pojavljajo tudi na nekaterih certoških fibulah z grobišča pri Socerbu (Mahr 1934, t. 30).

V uporabi so bili v vseh treh mladohalštatskih stopnjah, v stopnji Sv. Lucija Ila (npr. Teržan, Lo Schiavo, Trampuž-Orel 1984, t. 61: D7; 69: A8), v stopnji IIb (npr. prav tam, t. 63: E7; 246: C3; Gabrovec 1974, t. 6: 24; 8: 3) in v stopnji IIc (npr. Teržan, Lo Schiavo, Trampuž-Orel 1984, t. 169: 10; Mlinar 2002, 50, kat. št. 25; Mlinar 2004, 137, sl. 8: 3).

Mnogo redkejši so obročki s šestimi neizrazitimi izrastki. V Posočju je bil eden odkrit na grobišču Pucarjev rob na Mostu na Soči (Mlinar 2002, 50, kat. št. 26), sicer pa se pojavljajo še na Medejskem hribu nad Medejo zahodno od Gorice (Furlani 1974–1975, 36, t. 4: 24–26) ter na grobiščih v okolici Čedadada (Pettarin 2006, 138, kat. št. 455 in 456, 231, op. 230, t. 26: 456), v Socerbu (Mahr 1934, t. 30; Vidulli Torlo 2002, t. na str. 51, 81, kat. št. 138, 140 in 141) ter na Goleku pri Vinici in v Podzemlju v Beli krajini (Gabrovec 1966, t. 18: 15; 23: 8; Dular 1978, t. 5: 10).

Mostarski primerek dokazuje, da so se pojavili že na koncu halštatske dobe. V isti čas, to je v stopnjo Sv. Lucija IIc, zelo verjetno sodijo tudi trije taki obročki z Medejskega hriba (sl. 6.5: 3–5 – Furlani 1974–1975, t. 4: 24–26). Na tem najdišču je bilo namreč najdenih 708 odlomkov bronastih predmetov, od katerih jih kar 430 pripada certoškim fibulam (prav tam, 40). Le na dveh odlomkih nog so krožci s piko (prav tam, t. 2: 13; 3: 16), kar pomeni, da sta pripadala eni od vrst, značilnih za stopnjo Sv. Lucija IIb (npr. Teržan, Trampuž 1973, t. 15: 1). Velika večina odlomkov pa očitno izvira od mlajših fibul različice IXa (sl. 6.24: 1, 4, 9, 10 – Furlani 1974–1975, t. 2: 1; 3: 1, 12, 15, 17 in 18) in od fibul X. vrste (sl. 6.24: 11, 12 – prav tam, t. 4: 1–11), kakršne so se pojavljale v stopnji Sv. Lucija IIc (Teržan 1976, 355 in 364).<sup>4</sup> Ker

<sup>4</sup> Biba Teržan v svoji razpravi o certoški fibuli (Teržan 1976) primerkov z Medejskega hriba, ki so bili predstavljeni komaj leto prej, še ni mogla upoštevati. Za fibule IX. vrste je značilna s svitkoma obdana kroglasta odebelitev na loku (prav tam, 329, IX. vrsta, 355, sl. 21: 4, 7; 371, sl. 39: 2, 5, 8). Primerki z Medejskega hriba so bili sodeč po eni celi fibuli in večjem odlomku loka (sl. 6.24: 1, 4 – Furlani 1974–1975, t. 2: 1; 3: 1) daljši od 8 cm in jih moramo zato uvrstiti v različico IXa, ki po Teržanovi obsega razmeroma velike fibule, medtem ko različici b in c združujeta majhne (Teržan 1976, 329).

Starejše fibule različice IXa so sicer manjše in značilne za Este, kjer se pojavijo v stopnji Este III srednje (prav tam, 355, sl. 21: 4, 7), šele mlajši primerki, ki so večji in bolj iztegnjeni in jih najdemo v grobovih stopnje Este III pozno (prav tam, 330, a, Este; Frey 1969, 24, sl. 11: Este III-spät, t. 33: 8), so znani tudi od drugod (Teržan 1976, 355). *Vendar se certoške fibule različice IXa z Medejskega hriba tipološko jasno ločijo od fibul te različice v Este po tem, da je na slednjih odebelitev s svitkoma tik ob peresovini, na fibulah z Medejskega hriba pa je precej daleč od nje.* Ta značilnost jih povezuje s poznimi fibulami različice IXa z Idrije pri Bači in s Koritnice (prav tam, 355, op. 80) ter s fibulami različice IXb iz Este (prav tam, 371,

no. 26), but otherwise appear also at Monte di Medea above Medea, west of Gorizia (Furlani 1974–1975, 36, Pl. 4: 24–26), and at cemeteries in the surroundings of Cividale del Friuli (Pettarin 2006, 138, cat. nos. 455 and 456, 231, note 230, Pl. 26: 456), at Socerb (Mahr 1934, Pl. 30; Vidulli Torlo 2002, Pl. on p. 51, 81, cat. nos. 138, 140, and 141), at Golek pri Vinici and at Podzemelj in Bela krajina (Gabrovec 1966, Pls. 18: 15; 23: 8; Dular 1978, Pl. 5: 10).

The example from Most na Soči proves that they had appeared already at the end of the Hallstatt period. Probably also three such rings from Monte di Medea (Fig. 6.5: 3–5 – Furlani 1974–1975, Pl. 4: 24–26) belong to the same time, i.e. phase Sveta Lucija IIc. Namely, 708 fragments of bronze items were found at this site, 430 of which belong to the Certosa fibulae (ibid., 40). Only two fragments of feet reveal ring-and-dots (ibid., Pls. 2: 13; 3: 16), which means that they belong to one of the types characteristic for phase Sveta Lucija IIb (e.g. Teržan, Trampuž 1973, Pl. 15: 1). The majority of fragments, however, obviously originates from the later fibulae of variant IXa (Fig. 6.24: 1, 4, 9, 10 – Furlani 1974–1975, Pls. 2: 1; 3: 1, 12, 15, 17, and 18) and from fibulae of type X (Fig. 6.24: 11, 12 – ibid., Pl. 4: 1–11), which appeared during phase Sveta Lucija IIc (Teržan 1976, 429–430, and 431).<sup>4</sup> Since the fragments of bronze items do not reveal a single one which could be placed

<sup>4</sup> Biba Teržan in her study on Certosa fibulae (Teržan 1976), could not have accounted for the items from Monte di Medea since these were presented only a year before. For fibulae of type IX, a globular thickening on the bow encompassed by two collars is characteristic (ibid., 329, type IX, 429, Fig. 21: 4, 7; 432, Fig. 39: 2, 5, 8). Examples from Monte di Medea were, judging from one entire fibula and a bigger fragment of a bow (Fig. 6.24: 1, 4 – Furlani 1974–1975, Pls. 2: 1; 3: 1), longer than 8 cm and must therefore be assigned to variant IXa, which according to Teržan consists of relatively large fibulae, while variants b and c unite small ones (Teržan 1976, 329).

Earlier fibulae of variant IXa are otherwise smaller and characteristic for Este, where they appear in phase Este III middle (ibid., 429, Fig. 21: 4, 7), only later examples, which are bigger and more stretched and are found in graves of phase Este III late (ibid., 330, a, Este; Frey 1969, 24, Fig. 11: Este III-spät, Pl. 33: 8), also appear elsewhere (Teržan 1976, 429). *Nevertheless, the Certosa fibulae of variant IXa from Monte di Medea typologically clearly differ from fibulae of this variant in Este in that with the latter the thickening with collars is located right by the spring, while on fibulae from Monte di Medea it is fairly far from it.* This characteristic connects them to late fibulae of variant IXa from Idrija pri Bači and from Koritnica (ibid., 430, note 80) and to fibulae of variant IXb from Este (ibid., 432, Fig. 39: 2, 5, 8) and from Idrija pri Bači (ibid., 330, b, 369, Fig. 39: 9), which belong, considering the grave groups, to phases Este III late or Sveta Lucija IIc. Due to these connections it is clear that also fibulae of variant IXa from Medejski hrib belong only to phase Sveta Lucija IIc, i.e. to the same time as fibulae of type X according to Teržan, which were found there.

med odlomki bronastih predmetov ni niti enega, ki bi ga lahko postavili v mlajšo železno dobo, gre nedvomno za najdišče iz zadnje stopnje halštatske dobe (Sv. Lucija IIc). Podzemeljski obroček s šestimi neizrazitimi izrastki pa je že mlajši, saj je na fibuli različice Gemeinleborn vrste Mötschwil, ki je značilna za srednjelatensko stopnjo LT C2 (Božič 1993, 197, 200, skupina C, št. 4).

### 6.2.3 TRORTASTA FIBULA VRSTE IIA PO OGRINOVİ

Odlomek trortaste fibule (sl. 6.2: 3) je sodil k trortasti fibuli vrste Iia po Ogrinovi, za katero so značilni odebelitev okroglega preseka in kroglasti ali ovalni gumbi, ki so včasih na svitkastih vratovih (Ogrin 1998, 108, sl. 10: a). Večina primerkov izvira z najdišč svetolucijske skupine halštatske kulture (Most na Soči in Kobarid v dolini Soče ter Bitnje v Bohinju – prav tam, 109, levi stolpec). Ogrinova je vrsto Iia trortastih fibul na podlagi grobov Sz 1670 in Sz 2224 z Mosta na Soči (Teržan, Lo Schiavo, Trampuž-Orel 1984, t. 159: C; 231: A) datirala v stopnjo Sv. Lucija Iia (Ogrin 1998, 118–119, sl. 27; 37: II a, b).

Pri kronološki opredelitvi te vrste pa ni upoštevala še enega groba z Mosta na Soči (Sz 229 – prav tam, 109, Fragmenti II. vrste) ter grobov 3 in 22 z Bitenju v Bohinju (Gabrovec 1974, t. 2 in 3: grob 3; 7: grob 22). Od teh treh grobov sodi tudi grob 3 z Bitenju v stopnjo Sv. Lucija Iia

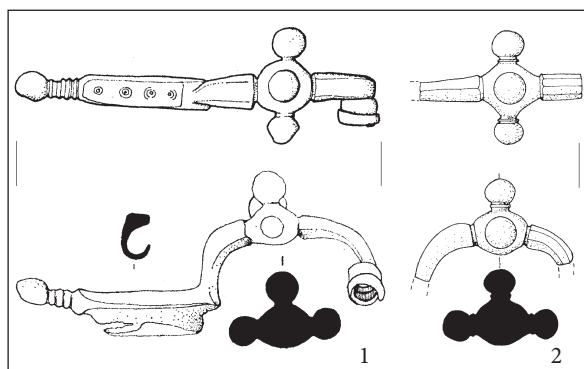

Sl. 6.6: Trortasti fibuli vrste Iia po Ogrinovi iz groba 22 na Bitnjah v Bohinju (1) in iz groba Sz 229 na Mostu na Soči (2). Obe bron. M. = 1:2 (1 Gabrovec 1974, t. 7; 2 Teržan, Lo Schiavo, Trampuž-Orel 1984, t. 21).

Fig. 6.6: Two three-knobbed fibulae of type Iia according to Ogrin from grave 22 at Bitnje in Bohinj (1) and from grave Sz 229 at Most na Soči (2). Both bronze. Scale = 1:2 (1 Gabrovec 1974, Pl. 7; 2 Teržan, Lo Schiavo, Trampuž-Orel 1984, Pl. 21).

sl. 39: 2, 5, 8) in z Idrije pri Bači (prav tam, 330, b, 369, sl. 39: 9), ki sodijo glede na grobne celote v stopnji Este III pozno oziroma Sv. Lucija IIc. Zaradi teh povezav je jasno, da sodijo tudi fibule različice IXa z Medejskega hriba šele v stopnjo Sv. Lucija IIc, to je v isti čas kot tam najdene fibule X. vrste po Teržanovi.

into the Late Iron Age, this is a site from the last phase of the Hallstatt period (Sveta Lucija IIc). The ring with six non-distinct knobs from Podzemelj is later since it appears on the fibula of Gemeinleborn variant of Mötschwil type, characteristic for Middle La Tène phase LT C2 (Božič 1993, 197, 200, group C, no. 4; 203).

### 6.2.3 THREE-KNOBBED FIBULA OF TYPE IIA ACCORDING TO OGRIN

A fragment of a three-knobbed fibula (Fig. 6.2: 3) belonged to the three-knobbed fibula of type Iia according to Ogrin, for which are characteristic the thickening of round cross section and globular or oval knobs that are occasionally on collar necks (Ogrin 1998, 108, Fig. 10: a). The majority of items originate from sites of the Sveta Lucija group of the Hallstatt culture (Most na Soči, Kobarid in the Soča Valley, and Bitnje in Bohinj – *ibid.*, 109, left column). Ogrin dated type Iia of three-knobbed fibulae on the basis of graves Sz 1670 and Sz 2224 from Most na Soči (Teržan, Lo Schiavo, Trampuž-Orel 1984, Pls. 159: C; 231: A) to phase Sveta Lucija Iia (Ogrin 1998, 118–119, Figs. 27; 37: II a, b; p. 131).

In the chronological classification of this type she did not consider another grave from Most na Soči (Sz 229 – *ibid.*, 109, Fragmenti II. vrste) and graves 3 and 22 from Bitnje in Bohinj (Gabrovec 1974, Pls. 2 and 3: grob 3; 7: grob 22). Among these three, grave 3 from Bitnje also belongs to phase Sveta Lucija Iia (*ibid.*, 301). The other two are later. Grave 22 from Bitnje belongs to phase Sveta Lucija Iib due to the arc fibula with lattice decoration on the flat bow (*ibid.*, Pl. 7: 9; Teržan, Trampuž 1973, 439), and grave Sz 229 from Most na Soči (Teržan, Lo Schiavo, Trampuž-Orel 1984, Pl. 21: C) to the same phase due to the rings decorated by groups of transverse incisions and clusters of ring-and-dots among them, and due to the fragment of a three-knobbed fibula of type VII (*ibid.*, Pl. 21: C2, 7, 10; Ogrin 1998, 125, type VII, right column, Fig. 35: 7–11; 132).

The two fibulae of type Iia according to Ogrin from the last two graves (Fig. 6.6: 1, 2) differ in the cross section of the bow from the fibulae of this type from graves of phase Sveta Lucija Iia. While all earlier fibulae have a round bow cross section, the fibula from grave 22 from Bitnje (Fig. 6.6: 1) has a faceted bow, and the fibula from grave Sz 229 at Most na Soči (Fig. 6.6: 2) a bow which is faceted at the front and is at the back angular in cross section (triangular or rhombic). On the fragment from Tonovcov grad (Fig. 6.2: 3), besides the thickening, only a part of the bow is preserved and is of a rhombic cross section. Hence this fragment most probably also belongs to phase Sveta Lucija Iib.

prav tam, 301). Druga dva pa sta mlajša. Grob 22 z Bitenj sodi v stopnjo Sv. Lucija Iib zaradi trakaste fibule z mrežastim okrasom na loku (prav tam, t. 7: 9; Teržan, Trampuž 1973, 430), grob Sz 229 z Mosta na Soči (Teržan, Lo Schiavo, Trampuž-Orel 1984, t. 21: C) pa v isto stopnjo zaradi prstanov, ki sta okrašena s snopi prečnih vrezov in s skupinami krožcev s piko med njimi, in zaradi odlomka trortaste fibule VII. vrste (prav tam, t. 21: C2, 7, 10; Ogrin 1998, 125, VII. vrsta, desni stolpec, sl. 35: 7–11).

Fibuli vrste Iia po Ogrinovi iz zadnjih dveh grobov (sl. 6.6: 1, 2) se po preseku loka razlikujeta od fibul te vrste iz grobov stopnje Sv. Lucija Iia. Medtem ko imajo vse starejše fibule okrogel presek loka, ima fibula iz groba 22 z Bitenj (sl. 6.6: 1) fasetiran lok, fibula iz groba Sz 229 na Mostu na Soči (sl. 6.6: 2) pa lok, ki je spredaj fasetiran, zadaj pa v preseku oglat (trikoten ali rombičen). Na odlomku s Tonovcovega gradu (sl. 6.2: 3) je poleg odebelitve ohranjen samo še delček loka, ki je rombičnega preseka. Zaradi tega sodi tudi ta odlomek najverjetneje v stopnjo Sv. Lucija Iib.

#### 6.2.4 STEKLENA JAGODA S PLASTOVITIMI MODRO-BELIMI OČESCI

V celoti ohranjena jagoda sploščeno kroglaste oblike iz modrozelenega stekla (sl. 6.2: 4) je okrašena s štirimi dvojnimi plastovitimi modro-belimi očesci.

Povsem enaka, le manjša jagoda je bila na primer odkrita v grobu Sz 229 z Mosta na Soči (Teržan, Lo Schiavo, Trampuž-Orel 1984, t. 21: C13; Kunter 1995, 357, kat. št. 1132), ki sem ga že omenil pri obravnavi odlomka trortaste fibule vrste Iia po Ogrinovi. Grob sodi v stopnjo Sv. Lucija Iib. Široko razprostranjene rumene in modrozeleno steklene jagode s plastovitimi očesci so značilnost 5. in 4. stoletja pr. n. št. (prav tam, 161, 5.4.7 Kombinationen, Zeitstellung). Na Dolenjskem se pojavljajo v grobovih certoške in negovske stopnje (sl. 6.7 – prav tam, 37, op. 100), v Posočju pa v grobovih stopenj Sv. Lucija Iib in Iic (prav tam, 38, grobišče na Koritnici in op. 112). Tako datacijo potrjuje tudi leta 2000 odkriti grob 19 na Repelcu na Mostu na Soči, ki je poleg odlomka certoške fibule vseboval tudi večje število rumenih steklenih jagod z enojnimi ali dvojnimi plastovitimi modro-belimi očesci (Mlinar 2008, 73, op. 94; 111–112, t. 15: R 19). Steklene jagode obravnavane vrste so bile v katalogu Szombathyjevih izkopavanj sicer pripisane tudi nekaterim grobovom iz starohalštatskega obdobja in iz stopnje Sv. Lucija Iia (Kunter 1995, 38, op. 110 in 111). Ker pa gre v teh primerih samo za posamezne jagode, pogosto celo samo za njihove odlomke, ne pa za ogrlice iz večjega ali manjšega števila jagod, in ker jih Szombathy v dnevnikih ne navaja med grobnimi pridatki, je najverjetnejša razlaga, da gre za posamezne najdbe, ki niso del grobne celote, ampak so bile preprosto dodeljene najbližjemu grobu (prav tam, 226–227, op. 757 in 758).

#### 6.2.4 GLASS BEAD WITH LAYERED BLUE AND WHITE EYES

The completely preserved bead of a flattened globular shape made of bluish green glass (Fig. 6.2: 4) is ornamented by four double layered blue and white eyes.

Completely identical but smaller bead was, for example, discovered in grave Sz 229 from Most na Soči (Teržan, Lo Schiavo, Trampuž-Orel 1984, Pl. 21: C13; Kunter 1995, 357, cat. no. 1132), which I have already mentioned during the discussion of the fragment of the three-knobbed fibula of type Iia according to Ogrin. The grave belongs to phase Sveta Lucija Iib. The widely distributed yellow and bluish green glass beads with layered eyes are characteristic for the 5<sup>th</sup> and 4<sup>th</sup> centuries BC (ibid., 161, 5.4.7 Kombinationen, Zeitstellung). In the Dolenjska region these appear in graves of the Certosa and Negova phases (Fig. 6.7 – ibid., 37, note 100) and in the Posočje area in graves of Sveta Lucija Iib and Iic phases (ibid., 38, cemetery at Koritnica and note 112). Such dating is also confirmed by grave 19, discovered in 2000 at Repelc in Most na Soči, which besides the fragment of a Certosa fibula also contained a larger number of yellow glass beads with single or double layered blue and white eyes (Mlinar 2008, 73, note 94; 111–112, Pl. 15: R 19). Glass beads of the discussed type were in the catalogue of the Szombathy excavations attributed also to a few graves from the Early Hallstatt period and from phase Sveta Lucija Iia (Kunter 1995, 38, notes 110 and 111). But because these graves include just individual beads, often even solely their fragments and not necklaces of large or small number of beads, and because Szombathy in his diaries does not list them among grave goods, it is the most probable explanation that these are isolated finds which are not part of a grave group but were simply assigned to the nearest grave (ibid., 226–227, notes 757 and 758).



Sl. 6.7: Steklena ogrlica iz groba 98 gomile 48 v Stični z modrozelenimi jagodami, ki so okrašene z enojnimi in dvojnimi plastovitimi modro-belimi očesci. M. = 1:1 (Gabrovec 2006, t. 55).  
Fig. 6.7: Glass necklace from grave 98 of mound 48 in Stična with blue-green beads decorated by single or double layered blue and white eyes. Scale = 1:1 (Gabrovec 2006, Pl. 55).



### 6.2.5 CERTOŠKA FIBULA Z DVOJNIM V-MOTIVOM NA NOGI

Tina Milavec je menila, da je odlomek certoške fibule (sl. 6.2: 5) pripadal fibuli X. vrste po Teržanovi (Milavec, Modrijan 2007, 110, op. 5). Tovrstne fibule so značilne za najmlajšo stopnjo svetolucijske kulture, to je stopnjo Sv. Lucija IIc (glej npr. Teržan, Lo Schiavo, Trampuž-Orel 1984, t. 8: A; 17: B1; 29: D1; 38: C1; 39: A1). Vendar pa imajo z dvojnimi V-motivom okrašeno nogo tudi nekatere fibule vrste VII, na primer različici a in d, ki se pojavljata tudi v Posočju (prav tam, t. 125: A1, 2; Teržan 1976, 325–328, sl. 3: d). Fibule različice VIIa so se po Teržanovi (prav tam, 357) na Dolenjskem pojavile že v certoški stopnji in ostale v uporabi še v negovski stopnji. Iz tega sledi, da bi bil odlomek certoške fibule s Tonovcovega gradu lahko tako iz stopnje Sv. Lucija IIB kot IIC.

### 6.2.6 NEGOVSKA ČELADA

Odlomek štule negovske čelade z ostanki okrasnega friza iz palmet in dvojnih krožcev (sl. 6.2: 6) je po Milavčevi sodil k negovski čeladi alpske vrste iz 4. stoletja pr. n. št. (Milavec, Modrijan 2007, 110–111, op. 7, sl. 4: 2). Pri tem se je oprla na palmete, ki so zelo podobne palmetam na čeladi alpske vrste, ki je bila najdena na najdišču Fallmeyerstraße v Innsbrucku na Tirolskem (sl. 6.8 – Egg 1986, 100, sl. 48: 6, Fries). Gre za posamezno najdbo (sl. 6.9 – prav tam, 236 in 238, kat. št. 354, t. 272; 273: a). Negovske čelade alpske vrste imajo na vrhu ozek greben, na prehodu zgornjega dela štule v vglobitev iztolčeno rebro in na krajcih visok pasasto razširjen rob (prav tam, 95–96, sl. 203 in 220). Markus Egg jih je razdelil na maloštevilno starejšo skupino z žigosanim okrasom (prav tam, 97–102) in na številčnejšo mlajšo z okrasom prepleta (prav tam, 102–112). Starejši skupini je lahko zanesljivo pripisal samo pet čelad (prav tam, 97, sl. 49). Štiri so bile najdene v južnoalpskih dolinah in na Tirolskem, ena pa v zakladni najdbi negovskih

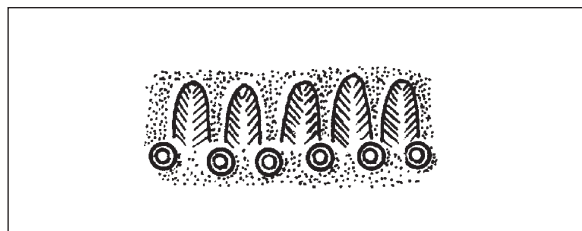

Sl. 6.8: Žigosani okras nad vglobitvijo štule na negovski čeladi alpske vrste z najdišča Fallmeyerstraße v Innsbrucku (Egg 1986, sl. 48).

Fig. 6.8: Stamped ornament above the recessed base of the cap on the Negova helmet of the Alpine type from the site Fallmeyerstraße in Innsbruck (Egg 1986, Fig. 48).

### 6.2.5 CERTOSA FIBULA WITH DOUBLE V-MOTIF ON FOOT

Tina Milavec believed that the fragment of a Certosa fibula (Fig. 6.2: 5) belonged to a fibula of type X according to Teržan (Milavec, Modrijan 2007, 109, note 5). Such fibulae are characteristic for the latest phase of the Sveta Lucija culture, i.e. phase Sveta Lucija IIc (see e.g. Teržan, Lo Schiavo, Trampuž-Orel 1984, Pls. 8: A; 17: B1; 29: D1; 38: C1; 39: A1). Yet there are some fibulae of type VII that also have the foot decorated by the double V-motif, such as variants a and d which also appear in the Posočje area (ibid., Pl. 125: A1, 2; Teržan 1976, 325–328, Fig. 3: d). Fibulae of variant VIIa according to Teržan (ibid., 430) appeared in Dolenjska already in the Certosa phase and remained in use still during the Negova phase. Thus the fragment of the Certosa fibula from Tonovcov grad could be from phase Sveta Lucija IIB as well as IIC.

### 6.2.6 NEGOVA HELMET

The fragment of a cap of the Negova helmet with remains of the ornamental frieze from palmettes and double rings (Fig. 6.2: 6) according to Milavec belonged to the Negova helmet of the Alpine type from the 4<sup>th</sup> century BC (Milavec, Modrijan 2007, 109, note 7, Fig. 4: 2). She based this on the palmettes, which are very similar to palmettes on the helmet of the Alpine type found at the site Fallmeyerstraße at Innsbruck in Tyrol (Fig. 6.8 – Egg 1986, 100, Fig. 48: 6, Fries). This is an



Sl. 6.9: Negovska čelada iz Innsbrucka. Pogled od strani (fotografija Rimsko-germanskega osrednjega muzeja v Mainzu).  
Fig. 6.9: Negova helmet from Innsbruck. Side view (photo from the Römisch-Germanisches Zentralmuseum in Mainz).

čelad iz Ženjaka v Slovenskih goricah. Ker nobena ne izvira iz zanesljive grobne celote, jih je samo na podlagi tipoloških značilnosti približno datiral v 4. stoletje pr. n. št. (prav tam, 102).

Vendar ima po prepričanju Egga povsem enake palmete in dvojne koncentrične krožce kot čelada iz Innsbrucka še ena negovska čelada, ki pa ni alpske vrste (prav tam, 83, Monrupino, op. 280, Kreisaguentyp 2, Gruppe 2f; 100, 98, op. 319, Kreisaguentyp 2, Gruppe 2f). Egg jo je uvrstil v različico Idrija slovenske vrste negovskih čelad (sl. 6.10 – prav tam, 82–86, sl. 38: 1, Fries). Odkrili so jo jamarji leta 1929 ob robu nasipnega stožca na dnu 78 m globokega navpičnega vhodnega brezna jame, ki leži blizu Repentabra (it. Monrupino) na Tržaškem Krasu (sl. 6.11 – prav tam, 229, kat. št. 332, t. 253; Gherlizza, Halupca 1988, 151–154). Njeno slovensko ime je Jama v Držencah, italijansko pa prav zaradi v njej odkrite čelade Grotta dell'elmo. Poleg čelade so našli nekaj odlomkov konjske mandibule (prav tam, 152).



Sl. 6.10: Žigosani okras nad vglobitvijo šture na negovski čeladi različice Idrija slovenske vrste iz Jame v Držencah pri Repentabru (fotografija Mestnih zgodovinskih in umetnostnih muzejev v Trstu).

Fig. 6.10: Stamped ornament above the recessed base of the cap on the Negova helmet of the Idrija variant of Slovenian type from Jama v Držencah near Repentabor (photo from the Civici Musei di Storia ed Arte in Trieste).

isolated find (Fig. 6.9 – *ibid.*, 236 and 238, cat. no. 354, Pls. 272; 273: a). The Negova helmets of the Alpine type have a narrow crest on the top, a hammered rib on the transition from the upper part of the cap to the recessed base, and a high ribbon-shaped edge of the brim (*ibid.*, 95-96, Figs. 203 and 220). Markus Egg divided them into the earlier, small in number, group with the stamped ornament (*ibid.*, 97-102) and into the larger later with the interlaced ornament (*ibid.*, 102-112). Only five helmets could have been attributed to the earlier group with certainty (*ibid.*, 97, Fig. 49). Four were found in the south-Alpine valleys and in Tyrol, and one was found within a hoard of Negova helmets from Ženjak in Slovenske gorice. Since none originates from a reliable grave group Egg approximately dated them to the 4<sup>th</sup> century BC on the basis of the typological characteristics (*ibid.*, 102).

According to Egg's belief, nevertheless, completely identical palmettes and double concentric rings as on the helmet from Innsbruck are found on another Negova helmet but which is not of the Alpine type (*ibid.*, 83, Monrupino, note 280, Kreisaguentyp 2, Gruppe 2f; 100, 98, note 319, Kreisaguentyp 2, Gruppe 2f). Egg assigned it to the Idrija variant of the Slovenian type of Negova helmets (Fig. 6.10 – *ibid.*, 82-86, Fig. 38: 1, Fries). It was discovered by a group of speleologists in 1929, at the edge of the talus cone at the bottom of the 78 m deep vertical entrance shaft of the cave, located near Repentabor (Ita. Monrupino) on Trieste Karst (Fig. 6.11 – *ibid.*, 229, cat. no. 332, Pl. 253; Gherlizza, Halupca 1988, 151-154). Its Slovenian name is Jama v Držencah, while in Italian it is due to the helmet discovered in it called Grotta dell'elmo. Besides the helmet a few fragments of the horse mandible were discovered (*ibid.*, 152).

Negova helmets of the Idrija variant of the Slovenian type have two flat bow-shaped loops for the chin-strap riveted to the brim lining (Egg 1986, 82, Figs. 189; 191). The helmet from Jama v Držencah is now missing the brim lining. According to the data

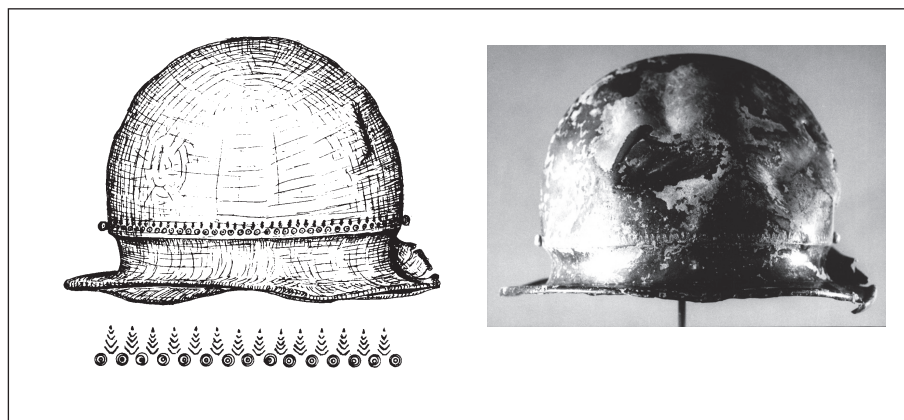

Sl. 6.11: Negovska čelada iz Jame v Držencah pri Repentabru. Pogled od strani (Gherlizza, Halupca 1988, stran 153 in fotografija Rimsko-germanskega osrednjega muzeja v Mainzu).

Fig. 6.11: Negova helmet from Jama v Držencah near Repentabor. Side view (Gherlizza, Halupca 1988, page 153 and photo from the Römisch-Germanisches Zentralmuseum in Mainz).

Negovske čelade različice Idrija slovenske vrste imajo na podlogi krajcev prikovičeni po dve trakasti ločni ušesci za podbradnik (Egg 1986, 82, sl. 189; 191). Pri čeladi iz Jame v Držencah podloga krajcev zdaj manjka. Po podatku Walterja Šmida, ki jo je še videl pred drugo svetovno vojno, sta bili na njej prikovičeni ušesci za podbradnik (prav tam, 229, kat. št. 332). Po Eggovem mnenju so čelade različice Idrija začeli izdelovati že v 4. stoletju pr. n. št. (prav tam, 85–86), potem pa so se spet pojavile v 1. stoletju pr. n. št. Med najstarejše primerke te različice moramo zaradi okrasa, ki je po Eggju pečatno enak tistemu na čeladi alpske vrste z žigosanim okrasom iz Innsbrucka, uvrstiti tudi čelado iz jame pri Repentabru.

Odlomek negovske čelade s Tonovcovega gradu je žal premajhen, da bi omogočal odločitev med pripadnostjo slovenski ali alpski vrsti. Iz dveh razlogov pa je precej verjetneje, da je sodil k čeladi slovenske vrste. Prvič je Innsbruck precej bolj oddaljen od Posočja kot Repentabor. Drugi razlog je razprostranjenost čelad. Kot sem omenil že zgoraj, so bile vse čelade alpske vrste z žigosanim okrasom razen ene (Ženjaj) najdene zahodno od Slovenije, vse čelade različice Idrija slovenske vrste negovskih čelad razen ene (Cazin v Bosni in Hercegovini) pa v Sloveniji oziroma tik za njeno mejo z Italijo (prav tam, 85, sl. 39). Odlomek s Tonovcovega gradu, katerega okras je izredno podoben okrasu na čeladah iz Innsbrucka in iz jame pri Repentabru, zelo verjetno tudi sodi v stopnjo Sv. Lucija IIc.

### 6.3 NAJDBE IZ MLAJŠE ŽELEZNE DOBE

Mlajšeželeznodobne najdbe s Tonovcovega gradu obsegajo dva dela orožja in del pasne garniture (zaključek koničnika nožnice, branik meča in obročasto pasno spono z jezičkom), osem odlomkov fibul (dveh srednje-latenske sheme vrste Idrija pri Bači, ene s tremi vozli na loku, dveh vrste Almgren 65 in treh vrste Jezerine) in pravokotno ploščico (sl. 6.2: 8–19).

#### 6.3.1 ZAKLJUČEK KONIČNIKA NOŽNICE LATENSKEGA MEČA

Na zaključku koničnika nožnice latenskega meča (sl. 6.2: 8) je razmeroma dobro ohranjena odebelitev nad ovalno razširitvijo na desnem kraku. Take odebelitve so značilnost koničnikov s predrtim zaključkom (Lejars 1994, 19, sl. 1). Zaključek s Tonovcovega gradu je po obliki in velikosti še najbližji zaključkom nekaterih koničnikov, ki jih je Thierry Lejars v obravnavi nožnic iz svetišča Gournay-sur-Aronde združil v skupino 4 (prav tam, 22–23, A - 4 - Groupe 4, 156, GSA 2111; 157, GSA 2148 in 2475). Ti koničniki so kratki, tanki in imajo majhni predrtini ter predstavljajo zadnjo stopnjo

by Walter Šmid, who had managed to see it before the Second World War, it had two riveted loops for the chin-strap (ibid., 229, cat. no. 332). According to Egg's opinion, the helmets of the Idrija variant started to be made already in the 4<sup>th</sup> century BC (ibid., 85–86) and they reappeared during the 1<sup>st</sup> century BC. The helmet from the cave near Repentabor also needs to be assigned among the earliest examples of this variant due to the ornament, which is according to Egg die identical to the one on the helmet of the Alpine type with the stamped ornament from Innsbruck.

The fragment of the Negova helmet from Tonovcov grad is unfortunately too small to enable the decision between the Slovenian and the Alpine type. Two reasons make it more likely to belong to the helmet of the Slovenian type. Firstly, Innsbruck is much further away from the Posočje area than Repentabor. The second reason lies in the distribution of helmets. As mentioned above, all but one (Ženjaj) helmet of the Alpine type with the stamped ornament were found west of Slovenia, while all helmets of the Idrija variant of the Slovenian type of Negova helmets except one (Cazin in Bosnia and Herzegovina) were found in Slovenia or immediately across its border with Italy (ibid., 85, Fig. 39). The fragment from Tonovcov grad, the ornament of which is extremely similar to the ornament of the helmets from Innsbruck and the cave at Repentabor, very probably also belongs to phase Sveta Lucija IIc.

### 6.3 LATE IRON AGE FINDS

Late Iron Age finds from Tonovcov grad contain two parts of weaponry and a part of a belt set (a chape end, a sword guard, and an annular belt hook with a tongue), eight fibula fragments (two fibulae of Middle La Tène scheme of the type Idrija pri Bači, one fibula with three knobs on the bow, two Almgren 65 type fibulae, and three Jezerine type fibulae), and a rectangular plate (Fig. 6.2: 8–19).

#### 6.3.1 LA TÈNE SWORD CHAPE END

The chape end of the La Tène sword (Fig. 6.2: 8) has a relatively well preserved thickening above the oval widening at the right section. Such thickenings are characteristic of chapes with an openwork end (Lejars 1994, 19, Fig. 1). The end from Tonovcov grad is in its shape and size closest to ends of certain chapes, which Thierry Lejars in his discussion of scabbards from the sanctuary Gournay-sur-Aronde united into group 4 (ibid., 22–23, A - 4 - Groupe 4, 156, GSA 2111; 157, GSA 2148 and 2475). These chapes are short, thin, and have two small openings and represent the last phase in the development of openwork chapes. On the basis of

v razvoju predrtih koničnikov. Lejars je nožnice s takimi zaključki na podlagi nekaterih grobnih celot datiral v stopnjo LT C1 (prav tam, 48–49).

### 6.3.2 OBROČASTA PASNA SPONA Z JEZIČKOM IN GUMBOM NA POŠEVNEM VRATU

Tako kot prejšnji predmet je tudi železna obročasta pasna spona (sl. 6.2: 9) slabo ohranjena, vendar dovolj, da je mogoča zanesljiva tipološka opredelitev. Tovrstne pasne spone so bile sestavni deli obročastih pasnih garnitur, kakršne so nosili keltski bojevniki v stopnji LT C2 (Božič 1999a, 210; Tomičič, Dizdar 2005, 89 in 91). Odlomek s Tonovcovega gradu sodi zaradi jezička hruškaste oblike v različico 4C1 po Bataillu (Bataille 2001, 451, sl. 3: 4C1; 6: 29–31, 46–47, 49, 52). V Slovenji se pojavljajo spone te različice še v Dobovi (sl. 6.12: 1 – Božič 1983, 78, sl. 22; Guštin, Egidi 2002, 78, Dobova, št. 6, sl. I.75) in Slatini v Rožni dolini (sl. 6.12: 2 – Pirkmajer 1991, t. 6: 36), na Hrvaškem pa v bojevnških grobovih grobišča stopnje LT C2 v Zvonimirovu v Podravini (sl. 6.12: 3 – Majnarić-Pandžić 2001, 87, t. 10: 5 in Dizdar 2007, 129).

V istem času je bila na približno istem prostoru v rabi nekoliko drugačna in razmeroma redka različica 4C3b po Bataillu (2001, 454, sl. 7: 61, 62) z navpičnim vratom, ki ne izhaja neposredno iz jezička, ampak je zakovan v okroglo ploščico, v katero preide jeziček, ki večinoma ni hruškast, ampak približno okrogel ali rombičen. Tej različici pripadata poleg dveh pasnih spon iz Slovenije, iz groba 13 v Slatini v Rožni dolini (Pirkmajer 1991, t. 13: 88) in iz groba 173 na Kapiteljski njivi v Novem mestu (Križ 2005, t. 46: 7), še ena iz groba LT 2 v Zvonimirovu (Tomičič, Dizdar 2005, 91, 115, Grob LT 2, št. 6, t. 4: 4) in bronasta pasna spona iz bojevnškega groba stopnje LT C2 v Amaru v Karniji (Righi 2001, 122, kat. št. 8, sl. 6: 8; Faleschini et al. 2009, 162, sl. 11: 8), ki ima na gumbu enak trikoten okrasek kot železna pasna spona te različice iz groba 13 v Slatini v Rožni dolini.

certain grave groups Lejars dated scabbards with such ends to phase LT C1 (ibid., 48–49).

### 6.3.2 ANNULAR BELT HOOK WITH A TONGUE AND A BUTTON ON THE INCLINED NECK

Similarly to the previous item the iron annular belt hook (Fig. 6.2: 9) is also poorly preserved, yet enough to enable the reliable typological classification. Belt hooks of this kind were a component part of annular belt sets as were worn by the Celtic warriors in phase LT C2 (Božič 1999a, 197; Tomičič, Dizdar 2005, 88–89, and 91). The fragment from Tonovcov grad belongs due to the pear-shaped tongue to variant 4C1 according to Bataille (Bataille 2001, 451, Figs. 3: 4C1; 6: 29–31, 46–47, 49, 52). In Slovenia, hooks of this variant appear also in Dobova (Fig. 6.12: 1 – Božič 1983, 78, Fig. 22; Guštin, Egidi 2002, 78, Dobova, no. 6, Fig. I.75) and Slatina v Rožni dolini (Fig. 6.12: 2 – Pirkmajer 1991, Pl. 6: 36), while in Croatia they are found in the warrior graves of phase LT C2 cemetery at Zvonimirovo in Podravina (Fig. 6.12: 3 – Majnarić-Pandžić 2001, 87, Pl. 10: 5 and Dizdar 2007, 129).

At the same time and at the approximately same space a somewhat different and relatively rare variant 4C3b according to Bataille (2001, 454, Fig. 7: 61, 62) was in use, which has a vertical neck, not prolonged directly from the tongue but riveted into a disc into which progresses the tongue that is mostly not pear-shaped but is approximately round or rhombic. To this variant belong two belt hooks from Slovenia, the one from grave 13 at Slatina v Rožni dolini (Pirkmajer 1991, Pl. 13: 88) and the one from grave 173 at Kapiteljska njiva in Novo mesto (Križ 2005, Pl. 46: 7), another one from grave LT 2 in Zvonimirovo (Tomičič, Dizdar 2005, 89, 115, Grab LT 2, no. 6, Pl. 4: 4), and a bronze hook from the warrior grave of LT C2 phase in Amaro in Carnia (Righi 2001, 122, cat. no. 8, Fig. 6: 8; Faleschini et al. 2009, 162, Fig. 11: 8), which has the same triangular ornament on the

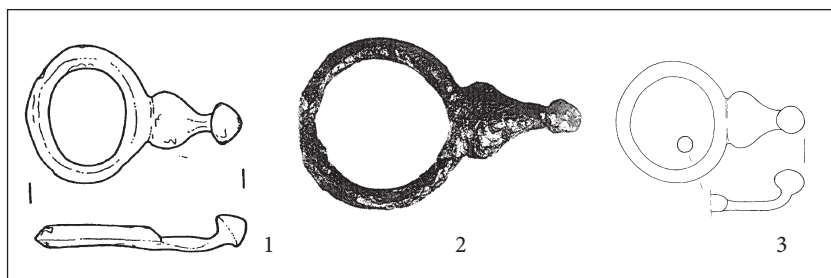

Sl. 6.12: Obročaste pasne spone s hruškastim jezičkom iz groba 22 v Dobovi (1), groba 1b v Slatini v Rožni dolini (2) in groba 12 v Zvonimirovu (3). Vse železo. M. = 1:2 (1 risba Inštituta za dediščino Sredozemlja ZRS UP v Ljubljani; 2 Pirkmajer 1991, t. 6; 3 Majnarić-Pandžić 2001, t. 10).

Fig. 6.12: Annular belt hooks with a pear-shaped tongue from grave 22 in Dobova (1), grave 1b in Slatina v Rožni dolini (2), and grave 12 in Zvonimirovo (3). All iron. Scale = 1:2 (1 drawing from the Institute for the Mediterranean Heritage of UP SRC in Ljubljana; 2 Pirkmajer 1991, Pl. 6; 3 Majnarić-Pandžić 2001, Pl. 10).

## 6.3.3 BRANIK LATENSKEGA MEČA

Tudi branik latenskega meča, ki ima visoko zvončasto obliko (sl. 6.2: 10), je razmeroma slabo ohranjen in skažen. Ker oblike meča, katerega del je bil, ne poznamo, ga lahko opredelimo samo nekoliko širše, saj se podobni braniki pojavljajo tako na mečih stopnje LT C2 (Tomičić, Dizdar 2005, 114, Grob LT 2, kat. št. 1, sl. 1 na str. 73 in t. 2: 1; Dizdar 2007, 138, Grob LT 8, kat. št. 1, t. 1: 10) kot na mečih, ki so značilni za stopnjo LT D1 (Gabrovec 1966, t. 3: 1; 4: 2; Knez 1977, t. 7: 4, 6).

## 6.3.4 FIBULI VRSTE IDRIJA PRI BAČI

Oba odlomka fibul srednjelatenske sheme s po dvema odebelitvama na zapognjeni nogi (sl. 6.2: 11 in 12) imata poškodovano objemko. Čeprav sta bila pripisana fibulam s tremi vozli na loku in ploščato okroglo razširitvijo na nogi (Milavec, Modrijan 2007, 110, op. 6; Milavec 2008, 9, op. 22, t. 1: 12, 14), ni dvoma, da gre za zapognjeni nogi fibul, ki jim je dal Mitja Guštin ime "fibule različice Idrija vrste Kastav" (Guštin 1987, 50, sl. 11: trikotnik; glej tudi Guštin 1991, 36–37), jaz pa zdaj zanje predlagam ime "fibule vrste Idrija pri Bači". Guštin je razdelil fibule vrste Kastav poleg različice Idrija (sl. 6.14) še na dve različici, na različico Kastav (sl. 6.13: 1) in različico Ribić (sl. 6.13: 2).

Od leta 1987 do zdaj se je število fibul vrste Kastav močno pomnožilo. Odkrita so bila nova najdišča, za nekatera pa se je izkazalo, da jih je treba z Guštinovega seznama izbrisati. Njegova tipološka razdelitev je doži-

button as the iron belt hook of this variant from grave 13 at Slatina v Rožni dolini.

## 6.3.3 GUARD OF LA TÈNE SWORD

The guard of the La Tène sword that has a high campanulate form (Fig. 6.2: 10) is also relatively poorly preserved and disfigured. Since we are not familiar with the shape of the sword, the part of which this guard was, it can only be delimited somewhat more widely because similar guards appear on swords of LT C2 phase (Tomičić, Dizdar 2005, 114, Grab LT 2, cat. no. 1, Fig. 1 on p. 73 and Pl. 2: 1; Dizdar 2007, 138, Grave LT 8, cat. no. 1, Pl. 1: 10) and on swords characteristic for phase LT D1 (Gabrovec 1966, Pls. 3: 1; 4: 2; Knez 1977, Pl. 7: 4, 6).

## 6.3.4 TWO FIBULAE OF IDRIJA PRI BAČI TYPE

Both fragments of Middle La Tène scheme fibulae with two thickenings on the bent foot (Fig. 6.2: 11 and 12) have a damaged clasp. Even though the fragments were attributed to fibulae with three knobs on the bow and a flat round widening on the foot (Milavec, Modrijan 2007, 109, note 6; Milavec 2008, 9, note 22, Pl. 1: 12, 14), there can be no doubt that these are bent feet of fibulae which Mitja Guštin called 'Idrija variant fibulae of the Kastav type' (Guštin 1987, 50, Fig. 11: triangle; see also Guštin 1991, 36–37), and for which I now suggest the name 'Idrija pri Bači type fibulae'. Guštin divided the Kastav type fibulae into three variants: the Idrija variant

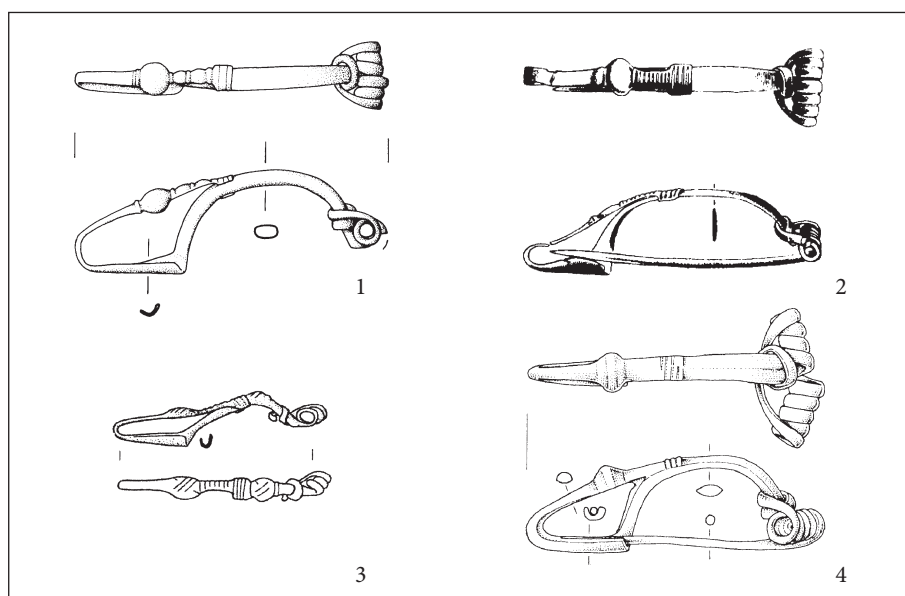

Sl. 6.13: Fibule vrste Kastav. 1 – različica Kastav, 2 – različica Ribić, 3 – različica Nezakcij, 4 – različica Ulaka. Vse bron. M. = 1:2 (1 Vidulli Torlo 2002, sl. 52; 2 Marić 1968, t. 13; 3 Blečić Kavur 2009, sl. 4; 4 Laharnar 2009, sl. 8).

Fig. 6.13: Kastav type fibulae. 1 – variant Kastav, 2 – variant Ribić, 3 – variant Nezakcij, 4 – variant Ulaka. All bronze. Scale = 1:2 (1 Vidulli Torlo 2002, Fig. 52; 2 Marić 1968, Pl. 13; 3 Blečić Kavur 2009, Fig. 4; 4 Laharnar 2009, Fig. 8).

vela pomembno razširitev z opredelitvijo ulite različice Ulaka (sl. 6.13: 4), ki se pojavlja samo v Ljublanici (Gaspari 2002, 149), na Notranjskem (Laharnar 2009, 129, desni stolpec, sl. 8 in 9 na str. 102) in z enim primerkom v zgornji Vipavski dolini<sup>5</sup> (Svoljšak 1983, t. 6: 165), ter vrste Nezakcij (sl. 6.13: 3 – Blečić Kavur 2009, 200, op. 18 in 19, sl. 4–5). Slednja si po mojem mnenju ne zasluži statusa vrste, ampak je *različica vrste Kastav*, ki je značilna za Istro, Kastav nad Reko in Cres (Blečić Kavur 2010, 332, sl. 253–255; 579, seznam 62) in se od drugih različic te vrste razlikuje predvsem po tem, da je precej manjša, da ima kolenast obris loka, da ima na njem še en tak gumb kot na zapognjeni nogi in da sta gumba okrašena.

Če je uvrstitev fibul različic Kastav, Ribić, Nezakcij in Ulaka (sl. 6.13) v vrsto Kastav povsem umestna, pa to nikakor ne velja za fibule različice Idrija (sl. 6.14). Te se namreč od fibul prej navedenih različic tipološko bistveno razlikujejo. Zato predlagam, da jih izločimo iz vrste Kastav po Guštinu in opredelimo kot novo *vrsto Idrija pri Bači*.

Fibule vrste Kastav brez različice Idrija po Guštinu (sl. 6.13) imajo na zapognjeni nogi en sam gumb. Objemka je kratka in okrašena s prečnimi vrezi. Lok, ki tekoče prehaja v nogo, je ovalnega, segmentnega ali bikonveksnega preseka. Peresovina je izdelana iz ploščate žice. Pri fibulah različic Kastav, Ribić in Nezakcij ima običajno šest navojev, pri fibulah različice Ulaka pa enkrat šest (sl. 6.21: 13 – Svoljšak 1983, t. 6: 165), večinoma pa devet ali več navojev. Tetiva se od znotraj ovija okrog loka.

Fibule, ki sodijo v "vrsto Idrija pri Bači" po mojem predlogu oziroma "različico Idrija vrste Kastav" po Guštinu (sl. 6.14), pa imajo na zapognjeni nogi dve različno veliki odebelitvi. Objemka je dolga in ima ob robovih izraziti prečni rebri. Lok, katerega prehod v nogo je kolenast, je večinoma okroglega, redko pa pravokotnega preseka. Peresovina je iz žice okroglega preseka in ima praviloma osem, izjemoma pa sedem navojev. Tetiva se od zunaj ovija okrog loka. Podobne zapognjene noge kot na Tonovcovem gradu (sl. 6.2: 11, 12) so bile med drugim najdene na kulturnem mestu na Kovačevšu nad Lokavcem (sl. 6.15: 1, 2) in v Socerbu (sl. 6.15: 3).

Popraviti je treba tudi časovno opredelitev fibul vrste Idrija pri Bači. Guštin je menil, da so te fibule v Posočju vodilna oblika srednjelatenske stopnje III in da se pojavljajo še v grobovih avgustejske stopnje IVb (Guštin 1991, 37). Iz moje kronološke analize grobnih celot s fibulami te vrste na Idriji pri Bači in iz dejstva, da se enaka peresovina z osmimi navoji in tetivo, ki se od zunaj ovija okrog loka, pojavlja na fibulah nekaterih drugih vrst, ki so zanesljivo iz stopnje LT D1,<sup>6</sup> pa izhaja,

<sup>5</sup> Na ta primerek me je opozoril Miha Mlinar iz Tolminskega muzeja v Tolminu.

<sup>6</sup> Glej moj članek o fibulah vrste Idrija pri Bači, ki je v pripravi.

(Fig. 6.14), the Kastav variant (Fig. 6.13: 1), and the Ribić variant (Fig. 6.13: 2).

Since 1987 the number of the Kastav type fibulae greatly increased. New sites appeared, while for some others it was shown that they need to be erased from Guštin's list. His typological division experienced a significant expansion with the definition of the cast variant Ulaka (Fig. 6.13: 4), which appears only in the river Ljublanica (Gaspari 2002, 149), in the Notranjska region (Laharnar 2009, 102, Figs. 8 and 9), and with one item in the upper Vipava Valley<sup>5</sup> (Svoljšak 1983, Pl. 6: 165), and the Nezakcij type (Fig. 6.13: 3 – Blečić Kavur 2009, 200, notes 18 and 19, Figs. 4–5). The latter, in my opinion, does not deserve the status of a type but is rather a *variant of the Kastav type*, typical for Istria, Kastav above Rijeka, and Cres (Blečić Kavur 2010, 332, Figs. 253–255; 579, list 62), and differs from other variants of this type mostly in its much smaller size, its knee-shaped bow outline, it has another knob on the bow besides the one on the bent foot, and both knobs are ornamented.

If the classification of fibulae of variants Kastav, Ribić, Nezakcij, and Ulaka (Fig. 6.13) into the Kastav type is completely appropriate, this is in no way true for fibulae of the Idrija variant (Fig. 6.14). These typologically significantly differ from previously enumerated variants. Thus I suggest that they be excluded from the Kastav type according to Guštin and classified as the new type Idrija pri Bači.

Fibulae of the Kastav type without the variant Idrija according to Guštin (Fig. 6.13) have just one knob on the bent foot. The clasp is short and ornamented with transversal incisions. The bow, which smoothly progresses into the foot, has an oval, segmented, or biconvex cross section. The spring is made of flat wire. In fibulae of variants Kastav, Ribić, and Nezakcij it usually has six coils, while in fibulae of the variant Ulaka it once has six (Fig. 6.21: 13 – Svoljšak 1983, Pl. 6: 165), but mostly nine or more coils. The chord is wrapped around the bow from inside.

On the other hand, fibulae which belong to 'the Idrija pri Bači type' according to my suggestion or to 'the Idrija variant of the Kastav type' according to Guštin (Fig. 6.14) have two thickenings of different sizes on the bent foot. The clasp is long and has two distinct transversal ribs along the edges. The bow, the transition of which into the foot is knee-shaped, most frequently has a round and seldom rectangular cross section. The spring is made of round wire and as a rule has eight, rarely seven coils. The chord is wrapped around the bow from outside. Similar bent feet as at Tonovcov grad (Fig. 6.2: 11, 12) were, among others, also found at the cult place of Kovačevše above Lokavec (Fig. 6.15: 1, 2) and at Socerb (Fig. 6.15: 3).

The dating of the Idrija pri Bači type fibulae also needs to be amended. Guštin believed that in the Posočje

<sup>5</sup> This item was brought to my attention by Miha Mlinar from Tolminski muzej in Tolmin.

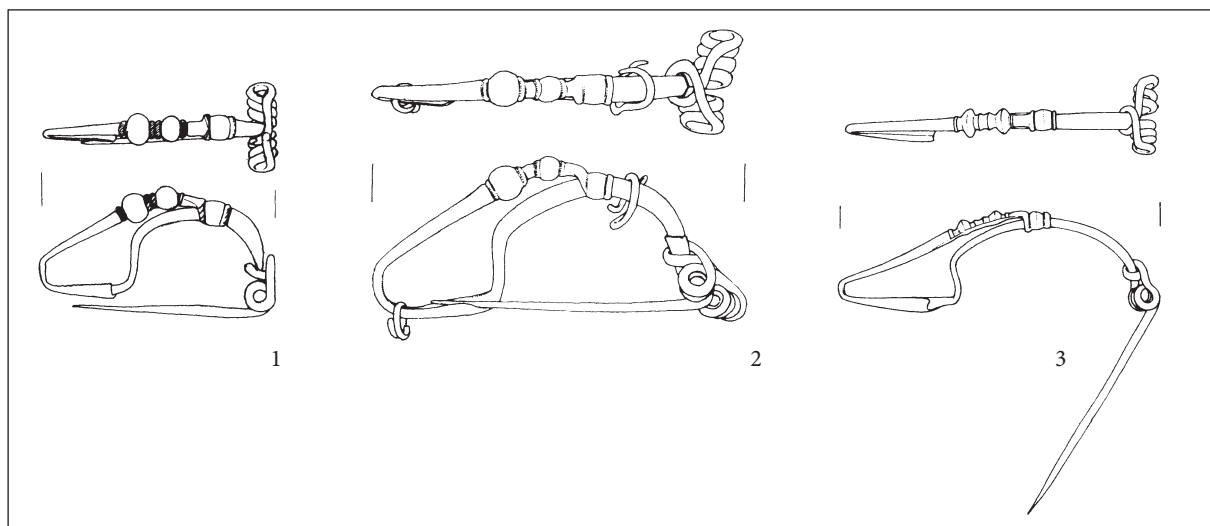

Sl. 6.14: Fibule vrste Idrija pri Bači iz grobov 9, 16 in 5 na Idriji pri Bači. Vse bron. M. = 1:2 (Guštin 1991, t. 10, 14 in 6).

Fig. 6.14: Fibulae of type Idrija pri Bači from graves 9, 16, and 5 at Idrija pri Bači. All bronze. Scale = 1:2 (Guštin 1991, Pls. 10, 14, and 6).

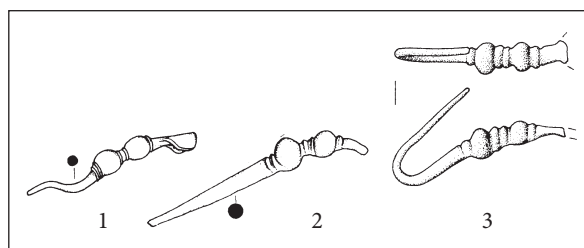

Sl. 6.15: Zapognjene noge fibul vrste Idrija pri Bači s Kovačevša nad Lokavcem (1 in 2) in iz Socerba (3). Vse bron. M. = 1:2 (1 in 2 Svöljšak 1983, t. 2; 3 Crismani, Righi 2002, kat. št. 30).

Fig. 6.15: Bent feet of Idrija pri Bači type fibulae from Kovačevše above Lokavec (1 and 2) and from Socerba (3). All bronze. Scale = 1:2 (1 and 2 Svöljšak 1983, Pl. 2; 3 Crismani, Righi 2002, cat. no. 30).

da je treba nastanek in uporabo fibul vrste Idrija pri Bači postaviti v to stopnjo, pri čemer ni dvoma, da se na Idriji pri Bači pojavljajo še v mlajših grobovih (7/8 in 16), v katerih pa fibule te vrste niso edini starejši pridelek.

#### 6.3.5 FIBULA SLOVENSKE VRSTE FIBUL SREDNJELATENSKE SCHEME S TREMI VOZLI NA LOKU IN Z OKROGLO PLOŠČICO NA ZAPOGNJENI NOGI

Odlomek loka bronaste fibule srednjelatenske sheme s tremi vozli na loku in z okroglo ploščico na zapognjeni nogi (sl. 6.2: 13) nima za tovrstne fibule značilne glave, ki je razmeroma debela in običajno okrašena s snopoma dveh ali treh poševnih črt (prim. npr. Gabrovec 1974, 298, t. 11: 13; Svöljšak 1983, t. 2: 65; Guštin 1991, t. 12: 2; 13: 1; 21: 13; 28: 4; 35: 2, 3 [tukaj: sl. 6.16: 2]), ampak koničasto glavo, ki je podobna tisti, ki jo ima ena od fibul iz groba 12 na Reki (prav tam, t. 35: 1 [tukaj: sl. 6.16: 1]). Ta je vtaknjena v stožčast tulec, ki nosi peresovino in iglo. Kot kaže, je imela na ta način izdelano peresovino tudi fibula s Tonovcovega gradu.

Fibule slovenske vrste fibul s tremi vozli na loku sta podrobneje obdelala Guštin (1991, 37–38) in Anne

area these fibulae are the leading form of Middle La Tène phase III and that they appear also in the graves of the Augustan phase IVb (Guštin 1991, 37). My chronological analysis of grave groups with fibulae of this type in Idrija pri Bači and the fact that the same spring with eight coils and a chord wrapped around the bow from outside appears on fibulae of several other types which are certainly from phase LT D1,<sup>6</sup> reveal that the emergence and use of the Idrija pri Bači type fibulae needs to be set in this phase. There can be no doubt that they at Idrija pri Bači also appear in later graves (7/8 and 16), but fibulae of this type are not the only earlier grave goods in them.

#### 6.3.5 FIBULA OF SLOVENIAN TYPE OF MIDDLE LA TÈNE SCHEME FIBULAE WITH THREE KNOBS ON BOW AND WITH DISC ON BENT FOOT

The fragment of a bronze Middle La Tène scheme fibula with three knobs on the bow and with a disc on the bent foot (Fig. 6.2: 13) does not have a typical head for such fibulae, which is relatively thick and usually

<sup>6</sup> See my article on Idrija pri Bači type fibulae, which is currently being prepared.

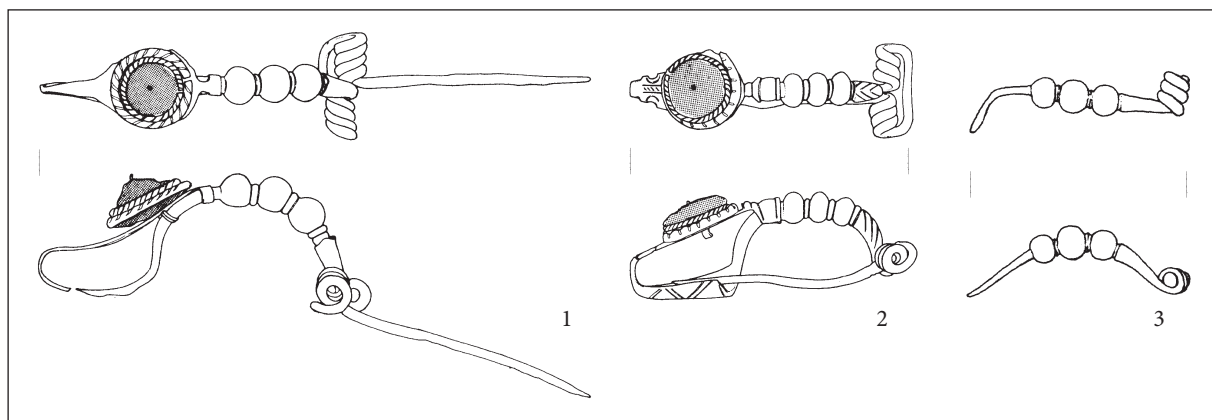

Sl. 6.16: Fibule s tremi vozli na loku iz groba 12 na Reki (1 in 2) in z območja župne cerkve v Kranju (3). 1 bron in smola, 2 srebro in smola, 3 srebro. M. = 1:2 (1 in 2 Guštin 1991, t. 35; 3 Horvat 1983, t. 6).

Fig. 6.16: Fibulae with three knobs on the bow from grave 12 at Reka (1 and 2) and from the area of the parish church in Kranj (3). 1 bronze and resin, 2 silver and resin, 3 silver. Scale = 1:2 (1 and 2 Guštin 1991, Pl. 35; 3 Horvat 1983, Pl. 6).

Marie Adam (Adam 1996, 190–191, sl. 26: d; 27: krožec; 193, d/Tipa sloveno). Njihovo dosedanjo datacijo v srednjo latensko dobo in v starejši del pozne latenske dobe (Guštin 1991, 38) je treba popraviti, saj so zelo verjetno sočasne fibulam vrste Idrija pri Bači, ki sodijo v stopnjo LT D1. Sočasnost fibul slovenske vrste in fibul vrste Idrija pri Bači lahko utemeljimo s tem, da se v treh grobovih na Idriji pri Bači (3, 13 in 24 – prav tam, t. 3; 12; 21) fibuli obeh vrst pojavljata skupaj, in s tem, da obe vrsti povezujejo nekatere enake prvine, na primer oblika objemke (prim. prav tam, t. 4: 4 s t. 13: 1), dva s presledkom ločena svitka (prim. prav tam, t. 14: 9 s t. 3: 15) ali trije svitki (prim. prav tam, t. 4: 1 s t. 13: 1 in 28: 4) med odebelitvami ter svitki, okrašeni s tankimi prečnimi vrezi (prim. prav tam, t. 10: 9 in 12: 1 s t. 3: 15 in 35: 4).

Odlomek s Tonovcovega gradu (sl. 6.2: 13) ima med vozli in na glavi po en oglat svitek. Tako oblikovane fibule niso pogoste. Znane so samo še z Reke v dolini Idrijce (sl. 6.16: 1, 2 – prav tam, t. 35: 1, 3 in 4) in iz Kranja na Gorenjskem (sl. 6.16: 3 – Horvat 1983, t. 6: 29). Svitka med vozli sta okrašena s tankimi prečnimi vrezi tako kot na eni od fibul z Reke (Guštin 1991, t. 35: 4).

### 6.3.6 PRAVOKOTNA PLOŠČICA

Delno poškodovana pravokotna ploščica (sl. 6.2: 14) je po načinu izdelave okrasa in delno tudi po upodobljenem motivu podobna najmanj šestim bronastim ploščicam, ki so bile najdene v železnodobno-rimskem svetišču na Gradiču nad Kobaridom (Osmuk 1987; Osmuk 1997; Osmuk 1998a). Objavljena je bila samo ena (sl. 6.17: 8 – Osmuk 1998b, 17, sl. 1 in 2). Štiri so kvadratne, dve pa sta pravokotni. Vseh šest ima ob robovih okvir iz štirih nizov pik oziroma bunčic, ki so na petih ploščicah iztolčene, na eni pa vtolčene. Ploščici s Tonovcovega gradu je po velikosti najbližja le malenkost

ornamented by two groups of two or three oblique lines (cf. e.g. Gabrovec 1974, 298, Pl. 11: 13; Svoljšak 1983, Pl. 2: 65; Guštin 1991, Pls. 12: 2; 13: 1; 21: 13; 28: 4; 35: 2, 3 [here: Fig. 6.16: 2]), but a pointed head similar to the one that is found on one of the fibulae from grave 12 at Reka (ibid., Pl. 35: 1 [here: Fig. 6.16: 1]). This is inserted into a conical socket with a spring and pin. As it seems the fibula from Tonovcov grad had a spring made in the same manner.

The fibulae of the Slovenian type of fibulae with three knobs on the bow were discussed in detail by Guštin (1991, 37–38) and Anne Marie Adam (Adam 1996, 190–191, Fig. 26: d; 27: ring; 193, d/Tipa sloveno). The dating up until now into the Middle and the earlier part of the Late La Tène period (Guštin 1991, 38) has to be corrected since these are very probably contemporary to fibulae of the Idrija pri Bači type, which belong to phase LT D1. The contemporaneity of fibulae of the Slovenian type and of Idrija pri Bači type originates from the fact that in three graves at Idrija pri Bači (3, 13, and 24 – ibid., Pls. 3; 12; 21) fibulae of both types appear together, and from the fact that both types are connected by certain identical elements, for example the shape of the clasp (cf. ibid., Pl. 4: 4 with Pl. 13: 1), the fact that on several fibulae of both types between the two thickenings two with a break separated collars (cf. ibid., Pl. 14: 9 with Pl. 3: 15) or three collars (cf. ibid., Pl. 4: 1 with Pls. 13: 1 and 28: 4) are located, and the fact that on fibulae of both types collars are sometimes ornamented with thin transversal incisions (cf. ibid., Pls. 10: 9 and 12: 1 with Pls. 3: 15 and 35: 4).

The fragment from Tonovcov grad (Fig. 6.2: 13) has two angular collars between the knobs and one on the head. Fibulae shaped in this manner are not frequent. They are known only from Reka in the Idrijca Valley (Fig. 6.16: 1, 2 – ibid., Pl. 35: 1, 3, and 4) and from Kranj in the Gorenjska region (Fig. 6.16: 3 – Horvat 1983, Pl. 6: 29). The two collars between the knobs are ornamented



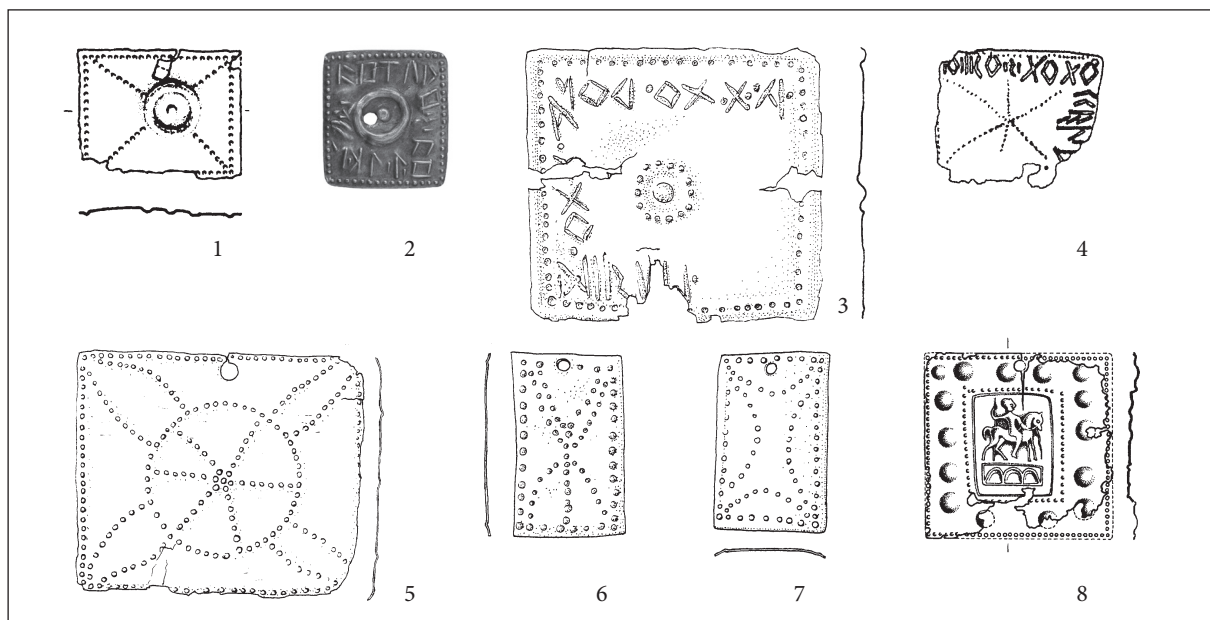

Sl. 6.17: Daritvene ploščice z Gradiča nad Kobaridom (1 in 8), z Vrh gradu pri Pečinah (2), z Gurine pri Dolah (3, 5–7) in s Colle Mazéit pri Verzegnisu (4). 2 srebro, drugo bron. M. = 1:2 (1 risba Območne enote Nova Gorica Zavoda Republike Slovenije za varstvo kulturne dediščine; 2 fotografija Tolminskega muzeja v Tolminu; 3, 5–7 Jablonka 2001, t. 124 in 126; 4 Vannacci Lunazzi 2001, sl. 5; 8 Osmuk 1998b, sl. 2).

Fig. 6.17: Offering plates from Gradič above Kobarid (1 and 8), Vrh gradu near Pečine (2), Gurina above Dellach (3, 5–7), and from Colle Mazéit near Verzegnis (4). 2 silver, others bronze. Scale = 1:2 (1 drawing from the Regional Unit Nova Gorica of the Institute for the Protection of Cultural Heritage of Slovenia; 2 photo from the Tolminski muzej in Tolmin; 3, 5–7 Jablonka 2001, Pls. 124 and 126; 4 Vannacci Lunazzi 2001, Fig. 2).

večja pravokotna ploščica z luknjico na sredini ene od daljših stranic, ki je znotraj okvira iz štirih pikčastih nizov okrašena s štirimi diagonalno razporejenimi pikčastimi kraki, ki segajo do sredinskega motiva, ki je sestavljen iz iztolčenega kroga s piko v sredini (sl. 6.17: 1). Povsem podoben motiv, kot je na ploščici s Tonovcovega gradu, to je pravokotnik oziroma kvadrat z vrčtanim križem, pa imajo tri ploščice kvadratne oblike.

Od šestih ploščic z Gradiča jih je pet okrašenih z geometrijskimi motivi. Šesta (sl. 6.17: 8 – Osmuk 1998b) pa ima znotraj zunanega kvadratnega okvira iz pikčastih nizov najprej kvadrat, sestavljen iz iztolčenih bunčic, nato pa pokončen pravokotni notranji okvir, narejen iz štirih nizov iztolčenih pik. Znotraj tega je le malo manjši pravokotni okvir iz štirih vtolčenih črt. Tako omejeno pravokotno središčno polje je zgoraj izpolnjeno z upodobitvijo konjenika z navpično postavljeno sulico v levici, spodaj pa s pravokotnim okvirom s tremi vrčtanimi loki.

Močno sorodna skupina daritvenih ploščic je znana z Gurine v zgornji Ziljski dolini (Jablonka 2001, 170–171, Verzierte Bleche, 179, t. 124: 1; 126: 1–5). Največja od šestih ploščic je skoraj kvadratna (sl. 6.17: 3), druge so pravokotne (sl. 6.17: 5–7). Na vseh je geometrijski okras. Tri imajo tako kot ploščice z Gradiča po eno luknjico na sredini ene od stranic (sl. 6.17: 5–7), na eni je luknjica na sredini (prav tam, t. 126: 4) in dve ploščici sta brez luknjice (prav tam, t. 126: 5 in sl. 6.17: 3). Vseh šest plo-

with thin transversal incisions as on one of the fibulae from Reka (Guštin 1991, Pl. 35: 4).

### 6.3.6 RECTANGULAR PLATE

The partly damaged rectangular plate (Fig. 6.2: 14) is in the manner of ornament manufacturing and partly also in the portrayed motif similar to at least six bronze plates found at the Iron Age-Roman sanctuary at Gradič above Kobarid (Osmuk 1987; Osmuk 1997; Osmuk 1998a). Only one has been published (Fig. 6.17: 8 – Osmuk 1998b, 17, Figs. 1 and 2). Four are square and two are rectangular. All six have along the edges a frame made of four rows of dots or bosses, which are hammered out on five of them and hammered in on only one. The closest in size to the plate from Tonovcov grad is the slightly bigger rectangular plate with a hole in the middle of one of the longer sides, which is inside the frame of four dotted rows ornamented by four diagonal dotted shanks reaching to the central motif, which is composed of a hammered out ring with a dot in the middle (Fig. 6.17: 1). A completely similar motif as on the plate from Tonovcov grad, meaning a rectangle or a square with an inscribed cross, is found on three plates of square shape.

Among six plates from Gradič, five are ornamented with geometrical motives. The sixth (Fig. 6.17: 8 – Os-

ščic je okrašenih z večinoma enojnim in samo enkrat z dvojnimi okvirom iz iztolčenih pik, ki je blizu roba. Na največji ploščici (sl. 6.17: 3) je na sredini krog s piko, ki pa ni sklenjen kot tisti na najmanjši ploščici z Gradiča (sl. 6.17: 1), ampak je sestavljen iz iztolčenih pik. Ob treh robovih te ploščice se vije daritveni napis iz venetskih črk.

Z najmanjšo ploščico z Gradiča in z največjo z Gurine je tesno povezana srebrna ploščica z najdišča Vrh gradu pri Pečinah na Šentviški planoti (sl. 6.17: 2 – Mlinar, Crevatin 2011). Po velikosti (3,3 x 3,7 cm) se približuje 4,2 x 3,4 cm veliki ploščici z Gradiča, ki ima na sredini povsem enak iztolčen krog s piko (sl. 6.17: 1). Po svoji skoraj kvadratni obliki in po venetskem napisu pa je zelo blizu ploščici z Gurine (sl. 6.17: 3). Kot zadnja sodi v obravnavano skupino bronasta ploščica s hriba Colle Mazéit pri Verzegnisu v Karniji, ki je bila leta 1991 odkrita z detektorjem za kovine (sl. 6.17: 4 – Vannacci Lunazzi 2001, 152–153, sl. 5: 1; Donat, Righi, Vitri 2007, 96 in 98, sl. 10: 1) in je bila potem žal prodana na trgu s starinami. Na tem hribu je bilo v mlajši železni dobi zanesljivo kultno mesto (prav tam, 96–98, sl. 10). Ploščica je trapezasta in okrašena z nizi pik. Znotraj pikčastega okvira je motiv X. Preko njegovega sečišča poteka še navpičen pikčast niz. Tako nastali šesterokraki motiv se pojavlja tudi znotraj pikčastega kroga na eni od ploščic z Gurine (sl. 6.17: 5). Tudi ploščica iz Verzegnisa nosi ob dveh robovih venetski napis (Crevatin 2001, 116–117, kat. št. 3; Donat, Righi, Vitri 2007, 98, levi stolpec). Ploščica s Tonovcovega gradu (sl. 6.2: 14) se od opisanih šestih ploščic z Gradiča nad Kobaridom, šestih z Gurine pri Dolah v Ziljski dolini in po ene z Vrh gradu pri Pečinah in s Colle Mazéit pri Verzegnisu razlikuje predvsem po tem, da ima štiri vogalne luknjice. Take luknjice se pojavljajo na nekaterih daritvenih ploščicah s figuralnim okrasom v venetskih svetiščih (glej na primer Ruta Serafini 2002, 233–247, sl. 100: 7, 8, 16; 102: 26; 283–295, sl. 125: 1, 7; 126: 14; 311–320, sl. 138: 7, 8, 12).

Povsem zanesljive datacije ploščic z Gurine, Gradiča, Vrh gradu, Colle Mazéit in s Tonovcovega gradu ni mogoče podati. Glede na njihovo precejšnjo oblikovno, tehnološko in okrasno povezanost pa smemo domnevati, da med njimi ni zelo velikih časovnih razlik. Datacijo v 2. in 1. stoletje pr. n. št. nakazuje ploščica s konjenikom z Gradiča (sl. 6.17: 8). Nada Osmuk (1998b) je namreč ugotovila, da konjenik in pravokotnik s tremi loki posnemata motiv na rimskem republikanskem denarju, ki je bil kovan v letih 114–113 pr. n. št. Ti dve leti sta torej terminus post quem za nastanek te ploščice. Seveda pa to ne pomeni, da podobnih ploščic niso izdelovali že nekaj desetletij prej oziroma tudi pozneje.

### 6.3.7 FIBULI VRSTE ALMGREN 65

Odlomek okviraste noge neke poznolatenske fibule (sl. 6.2: 15) je dolg 2,8 cm. Leva stranica okvira ima raven

muk (1998b) has within the outer square frame of dotted rows first a square, made of hammered out bosses, and then a vertical rectangular inner frame, made of four rows of hammered out dots. Within this frame is an only slightly smaller rectangular frame made of four hammered in lines. In this way delimited rectangular central field is on top filled with the portrait of a horseman with an erect spear in his left hand, while at the bottom there is a rectangular frame with three inscribed arches.

A closely related group of offering plates is known from Gurina in the upper Gail (Slov. Zilja) Valley (Jablunka 2001, 170–171, Verzierte Bleche, 179, Pls. 124: 1; 126: 1–5). The biggest among the six plates is almost square (Fig. 6.17: 3), others are rectangular (Fig. 6.17: 5–7). All have a geometrical ornament. Three have, just as the plates from Gradič, one hole in the middle of one of the sides each (Fig. 6.17: 5–7), one has a hole in the middle (ibid., Pl. 126: 4), and two plates are without a hole (ibid., Pl. 126: 5 and Fig. 6.17: 3). All six plates are ornamented with mostly single, only once with a double frame made of hammered out dots which is near the edge. The biggest plate (Fig. 6.17: 3) has a ring with a dot in the middle but the ring is here not joint as the one on the smallest plate from Gradič (Fig. 6.17: 1), rather it is assembled of hammered out dots. Along three edges of this plate runs an offering inscription in Venetic letters.

The smallest plate from Gradič and the biggest from Gurina are closely connected to the silver plate from the site Vrh gradu near Pečine on the Šentviška planota plateau (Fig. 6.17: 2 – Mlinar, Crevatin 2011). Its size (3.3 x 3.7 cm) is close to 4.2 x 3.4 cm plate from Gradič which has in the middle an identical hammered out ring with a dot (Fig. 6.17: 1). Due to its almost square shape and the Venetic inscription it comes very close to the plate from Gurina (Fig. 6.17: 3). The last of the discussed group is the bronze plate from the hill Colle Mazéit near Verzegnis in Carnia which was found with the help of the metal detector in 1991 (Fig. 6.17: 4 – Vannacci Lunazzi 2001, 152–153, Fig. 5: 1; Donat, Righi, Vitri 2007, 96 and 98, Fig. 10: 1) and was later, unfortunately, sold at the antiquity market. There was certainly a cult place on this hill in the Late Iron Age (ibid., 96–98, Fig. 10). The plate is of trapezoid shape and ornamented by rows of dots. The motif X is located within the dotted frame. A vertical dotted row runs also over its intersection. Thus created six-armed motif appears also within the dotted circle on one of the plates from Gurina (Fig. 6.17: 5). The plate from Verzegnis also carries a Venetic inscription along two of its edges (Crevatin 2001, 116–117, cat. no. 3; Donat, Righi, Vitri 2007, 98, left column). The plate from Tonovcov grad (Fig. 6.2: 14) differs from the described six plates from Gradič above Kobarid, six from Gurina above Dellach in the Gail Valley, one from Vrh gradu near Pečine, and one from Colle Mazéit near Verzegnis mostly in the fact that it has four corner holes. Such holes appear on several offering plates with the figural ornament in Venetic sanctuaries (see e.g. Ruta Serafini 2002, 233–247, Figs. 100:

zunanji rob, na notranjem robu pa je majhen trikoten izrastek, lepo viden na zadnji strani noge. Bolj ali manj izrazite trikotne izrastke imajo na notranji strani leve stranice okvira nekateri primerki naslednjih vrst fibul: tirolskih školjčnih in palmetastih fibul (Demetz 1999, t. 18: 1; 19: 1, 2), fibul s fasetiranim lokom (Meller 2002, t. 26: 316; 27: 319, 321), velikih fibul vrste Nova vas (Božič 2008, 86, sl. 37: 1, 5), delfinskih fibul (prav tam, sl. 42: 5) in fibul vrste Almgren 65 (Meller 2002, t. 28: 334; 29: 337, 341, 347; 30: 358, 360; Cunja, Mlinar 2010, 113, kat. št. 119). Ker nobena noga velikih fibul vrste Nova vas (Božič 2008, sl. 37) ne presega dolžine 2,3 cm in ker je edina ohranjena noga delfinskih fibul dolga le 1,7 cm (prav tam, sl. 42: 5), odlomek s Tonovcovega gradu ni pripadal nobeni od teh dveh vrst. Za to, da ne gre niti za odlomek noge fibule s fasetiranim lokom, govori zunanji rob leve stranice, ki je raven, ne pa razčlenjen (prav tam, sl. 43 na str. 85). Tudi možnost, da bi šlo za del tirolske školjčne ali palmetaste fibule, ni verjetna, ker v Posočju takih fibul ni (Demetz 1999, karta 19 in 20). Preostane samo še možnost, da gre za odlomek okviraste noge velike fibule vrste Almgren 65 (sl. 6.18), h kakršni je glede na mere sodil tudi odlomek glave z značilnim žlebičem na robu in s polovico peresovine iz šestih navojev (sl. 6.2: 16).

Dve veliki fibuli te vrste sta bili najdeni v grobovih 5 in 7/8 na Idriji pri Bači (Guštin 1991, 45–46, t. 6: 12; 10: 1 [tukaj: sl. 6.18: 1]), ena pa tudi v ustrini na Repelcu na Mostu na Soči (Mlinar 2008, 34, t. 25: 22; Cunja, Mlinar 2010, 113, kat. št. 118). Fibule vrste Almgren 65 (Demetz 1999, 27–38) so italške in so značilne za mlajši del stopnje LT D1 v srednjeevropskem smislu, to je za stopnjo LT D1b (Božič 2008, 145, tab. 5).

### 6.3.8 FIBULE VRSTE JEZERINE

Dva odlomka fibul vrste Jezerine (sl. 6.2: 18, 19) sodita v vrsto Jezerine IIa po Demetzu, ki ima na sre-

7, 8, 16; 102: 26; 283–295, Figs. 125: 1, 7; 126: 14; 311–320, Fig. 138: 7, 8, 12).

It is not possible to present a completely certain dating for the plates from Gurina, Gradič, Vrh gradu, Colle Mazéit, and from Tonovcov grad. Nevertheless, according to their considerable connection of shape, technology, and ornament we can assume that there exist no significant time differences among them. The dating into the 2<sup>nd</sup> and 1<sup>st</sup> centuries BC is indicated by the plate with a horseman from Gradič (Fig. 6.17: 8). Nada Osmuk (1998b) found that the horseman and the rectangle with three arches imitate the motif on the Roman republican denarius, which was minted in 114–113 BC. These two years are thus *terminus post quem* for the production of this plate. Indeed this does not mean that similar plates were not manufactured several decades before and after.

### 6.3.7 TWO FIBULAE OF ALMGREN 65 TYPE

The fragment of the open foot of the Late La Tène fibula (Fig. 6.2: 15) is 2.8 cm long. The left side of the frame has a straight outer edge, while the inner edge has a small triangular protuberance which is nicely visible on the back side of the foot. More or less distinct triangular protuberances are found on the inner edge of the frame's left side of several examples of the following fibula types: Tyrolean conchoidal and palmette fibulae (Demetz 1999, Pls. 18: 1; 19: 1, 2), fibulae with a faceted bow (Meller 2002, Pls. 26: 316; 27: 319, 321), big Nova vas type fibulae (Božič 2008, 86–87, Fig. 37: 1, 5), dolphin fibulae (ibid., Fig. 42: 5), and Almgren 65 type fibulae (Meller 2002, Pls. 28: 334; 29: 337, 341, 347; 30: 358, 360; Cunja, Mlinar 2010, 113, cat. no. 119). Since none of the feet of the big Nova vas type fibulae (Božič 2008, Fig. 37) exceeds the length of 2.3 cm and because the only preserved foot of the dolphin fibulae is no longer than 1.7 cm (ibid., Fig. 42: 5), the fragment from Tonovcov grad did not belong to either of these two types. To the fact that this cannot be

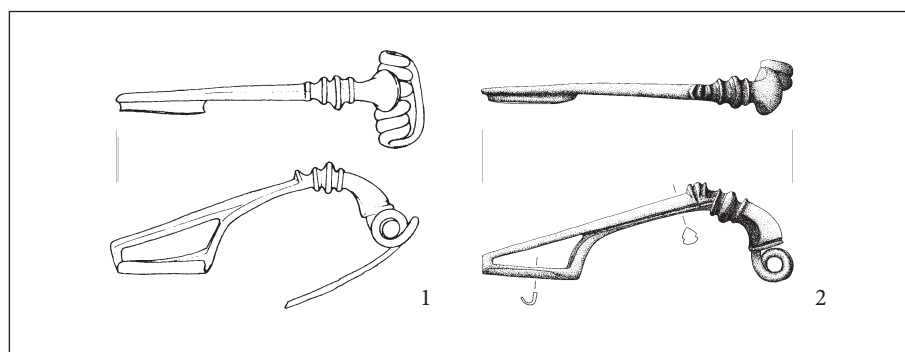

Sl. 6.18: Veliki fibuli vrste Almgren 65 iz groba 7/8 na Idriji pri Bači (1) in iz svetišča Reitije v Este (2). Obe bron. M. = 1:2 (1 Guštin 1991, t. 10; 2 Meller 2002, t. 32).

Fig. 6.18: Two big Almgren 65 type fibulae from grave 7/8 at Idrija pri Bači (1) and from the Reitia sanctuary in Este (2). Both bronze. Scale = 1:2 (1 Guštin 1991, Pl. 10; 2 Meller 2002, Pl. 32).

dini loka ozko in nizko rebro (Demetz 1999, 100, t. 25: 3, 4). Robova sta včasih rahlo dvignjena (sl. 6.19: 2). Podobno majhna fibula te vrste je bila najdena v sondi 19 na Cvingerju nad Virom pri Stični (Gabrovec 1994, 174, t. 16: 46).

Odlomek loka s širino 1,2 cm (sl. 6.2: 17) pa zaradi treh približno enakih reber pripada vrsti IIb po Demetzu (sl. 6.19: 1 – Demetz 1999, 100, t. 25: 5). Fibule vrste Jezerine (prav tam, 99–105) so tako kot fibule vrste Almgren 65 italške in jih ravno tako najdemo med pridatki grobov na Idriji pri Bači (Guštin 1991, 41–42, t. 20: 2; 21: 9), pa tudi v naselbini na Mostu na Soči (Cunja, Mlinar 2010, 114, kat. št. 128). Značilne so za mlajši del pozne latenske dobe, to je za stopnjo LT D2 (Božič 2008, 146–147, tab. 5). Brez opravljene analize ni mogoče reči, iz katere bakrove zlitine so izdelane (Istenič, Šmit 2007, 144–145, Results).

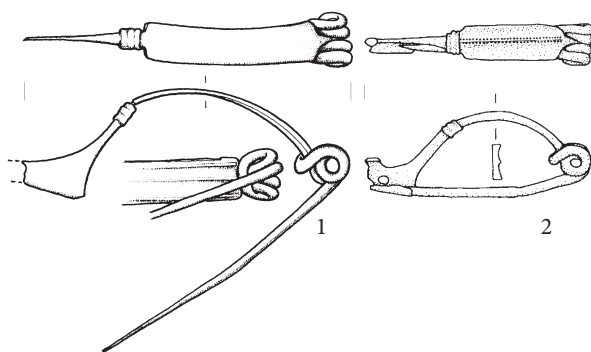

Sl. 6.19: Fibuli vrste Jezerine iz groba 140 na Beletovem vrtu v Novem mestu (1) in iz San Giorgia di Nogaró (2). Obe bakrova zlitina. M. = 1:2 (1 Knez 1992, t. 51; 2 Buora, Seidel 2008, kat. št. 116).

Fig. 6.19: Two fibulae of the Jezerine type from grave 140 at Beletov vrt in Novo mesto (1) and from San Giorgia di Nogaró (2). Both copper alloy. Scale = 1:2 (1 Knez 1992, Pl. 51; 2 Buora, Seidel 2008, cat. no. 116).

## 6.4 ŽELEZNODOBNE NAJDBE S TONOVCOVEGA GRADU V PRIMERJAVI Z NAJDBAMI V SVETIŠČIH IN NA KULTNIH MESTIH

Od skupno 19 drobnih železnodobnih najdb s Tonovcovega gradu (sl. 6.2) jih je sedem iz starejše železne, dvanajst pa iz mlajše železne dobe.

Halštatske najdbe obsegajo predvsem dele noše – odlomka fibul (sl. 6.2: 3, 5), polovico votlega kroglastega obeska, kakršni so bili obešeni na svetolucijske ločne fibule (sl. 6.2: 1), ter dva obročka s šestimi izrastki, od katerih bi bil tisti z izrazitimi izrastki (sl. 6.2: 2) tudi lahko obesek na svetolucijski ločni fibuli, medtem ko je bil mlajši (sl. 6.2: 7) prav tako gotovo del ženske noše. Po en predmet pripada nakitu (steklena jagoda ogrlice – sl. 6.2: 4) in orožju (odlomek negovske čelade – sl. 6.2: 6).

a foot fragment of a fibula with a faceted bow testifies the outer edge of the left side that is straight and not indented (ibid., Fig. 43 on p. 85). It is also not very likely that this is a part of the Tyrolean conchoidal or palmette fibula since no such fibula was ever found in the Posočje area (Demetz 1999, maps 19 and 20). The only remaining option is that this is a fragment of an open foot of a big fibula of Almgren 65 type (Fig. 6.18). To this variant, according to the measures, we can attribute also the fragment of a head with a typical groove at the edge and one half of the six-coil spring (Fig. 6.2: 16).

Two big fibulae of Almgren 65 type were found in graves 5 and 7/8 at Idrija pri Bači (Guštin 1991, 45–46, Pls. 6: 12; 10: 1 [here: Fig. 6.18: 1]) and another one in the ustrinum at Repelc in Most na Soči (Mlinar 2008, 34, Pl. 25: 22; Cunja, Mlinar 2010, 113, cat. no. 118). Fibulae of the Almgren 65 type (Demetz 1999, 27–38) are Italic and are characteristic for the later part of phase LT D1 in the Central European sense, that is phase LT D1b (Božič 2008, 145, Tab. 5).

### 6.3.8 FIBULAE OF JEZERINE TYPE

Two fragments of the Jezerine type fibulae (Fig. 6.2: 18, 19) belong to type Jezerine IIa according to Demetz and have in the middle of the bow a narrow and low rib (Demetz 1999, 100, Pl. 25: 3, 4). The edges are occasionally slightly lifted (Fig. 6.19: 2). A similarly small fibula of this type was found in trench 19 at Cvinger above Vir pri Stični (Gabrovec 1994, 175, Pl. 16: 46).

The fragment of a bow with the width of 1.2 cm (Fig. 6.2: 17) due to the three approximately equal ribs belongs to type IIb according to Demetz (Fig. 6.19: 1 – Demetz 1999, 100, Pl. 25: 5). Fibulae of the Jezerine type (ibid., 99–105) are so as Almgren 65 type fibulae Italic and can also be found among the grave goods at Idrija pri Bači (Guštin 1991, 41–42, Pls. 20: 2; 21: 9), as well as in the settlement at Most na Soči (Cunja, Mlinar 2010, 114, cat. no. 128). They are characteristic for the later part of the Late La Tène period, i.e. phase LT D2 (Božič 2008, 146–147, Tab. 5). Without the conducted analysis it is impossible to say from which copper alloy they are made of (Istenič, Šmit 2007, 144–145, Results).

## 6.4 IRON AGE FINDS FROM TONOVCOV GRAD NEAR KOBARID IN COMPARISON TO FINDS FROM SANCTUARIES AND CULT PLACES

From 19 small Iron Age finds at Tonovcov grad (Fig. 6.2) seven belong to the Early Iron Age and twelve to the Late Iron Age.

Hallstatt finds include mostly parts of attire – two fibula fragments (Fig. 6.2: 3, 5), one half of a hollow

Podobno sestavo kažejo latenske najdbe. Poleg osmih odlomkov fibul (*sl.* 6.2: 11–13, 15–19) so med njimi še orožje (branik meča in zaključek koničnika nožnice – *sl.* 6.2: 10, 8) in del vojaškega pasu (odlomek obročaste pasne spona – *sl.* 6.2: 9). Novost tega časa pa je daritvena ploščica (*sl.* 6.2: 14).

Obroček s šestimi izrazitimi zrastki (*sl.* 6.2: 2) bi bil lahko že iz stopnje Sv. Lucija IIa, vendar so bili taki obročki v uporabi vse do stopnje IIc. Druge najdbe se uvrščajo v vse poznohalštatske in latenske stopnje od stopnje Sv. Lucija IIb (*sl.* 6.2: 1, 3) do stopnje LT D2 (*sl.* 6.2: 17–19).

Več možnih odgovorov na vprašanje, s kakšno človeško dejavnostjo so povezane železnodobne najdbe na Tonovcovem gradu, je podal že Ciglencčki (1997, 7–8). Zaradi odsotnosti železnodobne keramike, ki bi morala biti v primeru uporabe hriba za naselje ali kratkotrajno pribežališče prisotna, in zaradi velike podobnosti predmetov z najdbami, ki so jih našli v nekaterih svetiščih in na kulturnih mestih v Karniji, Furlaniji, Posočju in na Notranjskem (*sl.* 6.20), je po mojem mnenju najverjetnejša tista možnost, ki jo je Ciglencčki navedel predvsem zaradi bronaste daritvene ploščice: "Najdbe

globular pendant such as were hung on the Sveta Lucija bow fibulae (*Fig.* 6.2: 1), and two rings with six knobs, of which the one with distinct knobs (*Fig.* 6.2: 2) could also have been a pendant on the Sveta Lucija bow fibula, while the later one (*Fig.* 6.2: 7) was definitely also a part of the female attire. There is one example of jewellery (a glass bead of a necklace – *Fig.* 6.2: 4) and one of weapons (a fragment of a Negova helmet – *Fig.* 6.2: 6).

La Tène finds reveal a similar composition. Beside eight fibula fragments (*Fig.* 6.2: 11–13, 15–19) also weapons (a guard of a sword and a chape end – *Fig.* 6.2: 10, 8) and a part of a military belt (a fragment of an annular belt hook – *Fig.* 6.2: 9) can be found. The novelty of this time is the offering plate (*Fig.* 6.2: 14).

The ring with six distinct knobs (*Fig.* 6.2: 2) could have already originated from phase Sveta Lucija IIa, even though such pendants were in use until phase IIc. Other finds belong to all final Hallstatt and La Tène phases from phase Sveta Lucija IIb (*Fig.* 6.2: 1, 3) to phase LT D2 (*Fig.* 6.2: 17–19).

Several possible answers to the question to which human activity the Iron Age finds from Tonovcov grad are connected to were given by Ciglencčki (1998, 7–8).

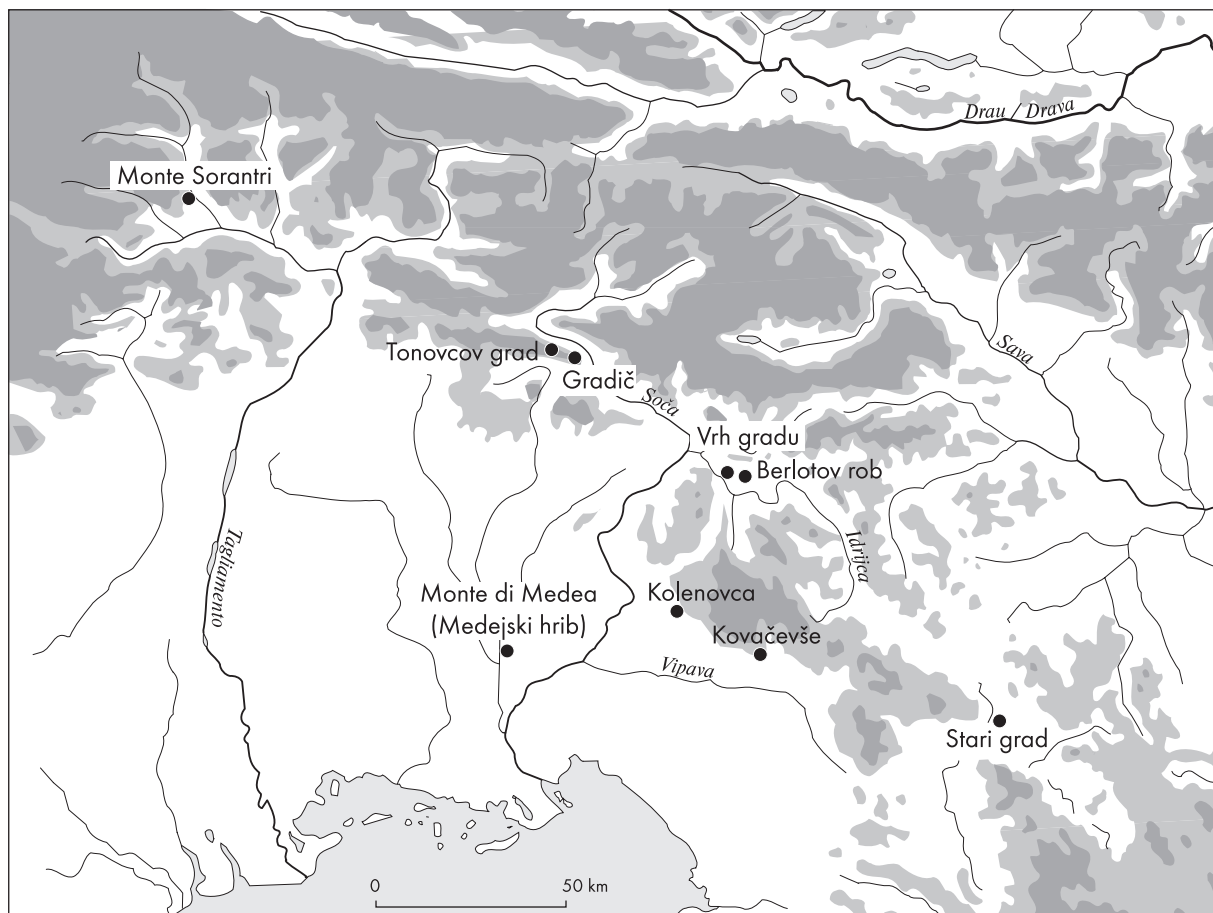

*Sl.* 6.20: Izbrana železnodobna svetišča in kulturna mesta v Karniji, Furlaniji, Posočju in na Notranjskem.

*Fig.* 6.20: Selected Iron Age sanctuaries and cult places in Carnia, Friuli, the Soča region, and Notranjska region.

iz halštatske in latenske dobe izvirajo s kultnega mesta nekje na Tonovcovem gradu.”

V prid tej razlagi govori značaj prej omenjenih svetišč in kulturnih mest, ki si jih velja nekoliko podrobneje ogledati.

#### 6.4.1 SOŠKA DOLINA

Pri večini halštatskih in latenskih fibul, ki so jih našli v železnodobno-rimskem svetišču na Gradiču nad Kobaridom (Osmuk 1998a), gre podobno kot na Tonovcovem gradu za večje ali manjše odlomke.<sup>7</sup> Cele ali skoraj cele so zlasti nekatere rimskodobne fibule. Med tu najdenimi daritvenimi ploščicami<sup>8</sup> je več takih, ki imajo enak okras kot ploščica s Tonovcovega gradu, to je motiv črke X znotraj kvadrata oziroma pravokotnika. Po drugi strani pa so med obema najdiščema tudi pomembne razlike, saj so na Gradiču na primer našli številne bronaste kipce rimskih bogov, darovalcev in svečenika (Osmuk 1987; Osmuk 1997) ter keramične posode, uvožene iz Italije (Osmuk 1998a; Mlinar 2011a).

#### 6.4.2 VIPAVSKA DOLINA

Že Drago Svoljšak je v objavi najdb, ki so jih našli deloma domačini, deloma pa arheologi iz Ljubljane in Nove Gorice med izkopavanji v letih 1949 in 1983 v nekaj kvadratnih metrov veliki jami na Kovačevšu nad Lokavcem blizu Ajdovščine v zgornji Vipavski dolini (sl. 6.21), kot eno od več možnih razlag omenil, da so bili predmeti vanjo morda obredno nasipani postopoma, v časovnem zaporedju (Svoljšak 1983, 5, sl. 2 in stran 9; t. 1–6). Mnogo pozneje je Paul Gleirscher (2002, 174, sl. 1: 187; 188, desni stolpec; 258, kat. št. 187) v objavi žgalnodaritvenega mesta Rungger Egg pri Seisu na Južnem Tirolskem to jamo zaradi njene lege, razkosačnosti predmetov ter njihove sestave jasno opredelil kot daritveno mesto. V prid tej razlagi govori tudi Svoljšakov podatek, da so bile v zasutju jame tudi nedogorele kosti in koščki žganine.<sup>9</sup> Kovinske in steklene najdbe so razen ene močno profilirane fibule (Svoljšak 1983, t. 1: 23) železnodobne. Odlomki keramičnih posod (npr. deli vrčev in tere sigilate) pa so večinoma rimskodobni (prav tam, 8). Najdbe iz starejše in mlajše železne dobe obsegajo fibule, obročast nakit, steklene jagode, obeske

<sup>7</sup> S fibulami iz svetišča na Gradiču nad Kobaridom in z nekaterimi drugimi tam odkritimi najdbami me je seznanila Nada Osmuk iz Nove Gorice, ki je vodila izkopavanja.

<sup>8</sup> Štirje primerki so razstavljeni v prostoru z imenom Kobariška kulturna krajina stalne razstave Tolminskega muzeja v Tolminu (Mlinar 2011a, 22–23).

<sup>9</sup> Podatek o nedogorelih kosteh in koščkih žganine navaja Svoljšak samo v slovenskem besedilu (1983, 9), v zelo kratkem italijanskem povzetku pa ne.

Due to the absence of Iron Age pottery, which would in the case of use of the hill for a settlement or a short-term refuge have to be present, and due to great similarity of items to the finds from several sanctuaries and cult places in Carnia, Friuli, the Posočje area, and the Notranjska region (Fig. 6.20), I believe the most probable to be the option that Ciglencečki stated mostly due to the bronze offering plate: 'Finds from the Hallstatt and La Tène periods originate from the cult place somewhere at Tonovcov grad.'

In favour of this explanation speaks also the character of the above mentioned sanctuaries and cult places, which are worth taking a closer look.

#### 6.4.1 THE SOČA VALLEY

Most of the Hallstatt and La Tène fibulae that were found at the Iron Age-Roman sanctuary Gradič above Kobarid (Osmuk 1998a) are, similarly to Tonovcov grad, bigger or smaller fragments.<sup>7</sup> Whole or nearly whole are mostly some fibulae of the Roman period. Several among the offering plates<sup>8</sup> found here have the same ornament as the plate from Tonovcov grad, that is the motif of the letter X within the square or rectangle. On the other hand, both sites also reveal significant differences, since at Gradič, for example, numerous bronze statuettes of Roman gods, offerers, and a priest (Osmuk 1987; Osmuk 1997) and pottery vessels imported from Italy (Osmuk 1998a; Mlinar 2011b) were found.

#### 6.4.2 THE VIPAVA VALLEY

Drago Svoljšak in his publication of finds that were partly found by the locals and partly by the archaeologists from Ljubljana and Nova Gorica during the excavations of 1949 and 1983 in a few m<sup>2</sup> big pit at Kovačevše above Lokavec near Ajdovščina in the upper Vipava Valley (Fig. 6.21) mentioned as one of the possible explanations that the items could have been ritually placed there gradually, in a time sequence (Svoljšak 1983, 5, Fig. 2 and p. 9; Pls. 1-6). Much later Paul Gleirscher (2002, 174, Fig. 1: 187; 188, right column; 258, cat. no. 187) in his publication of the burnt-offering site Rungger Egg near Seis in South Tyrol clearly defined this pit as an offering place due to its position, item fragmentation, and their composition. In favour of this explanation speaks

<sup>7</sup> Fibulae from the sanctuary at Gradič above Kobarid and some other finds from that site were brought to my attention by Nada Osmuk from Nova Gorica who led the excavations.

<sup>8</sup> Four items are exhibited in the sector named Kobariška kulturna krajina (Cult region of Kobarid) of the Tolminski muzej permanent exhibition in Tolmin (Mlinar 2011b, 22–23).

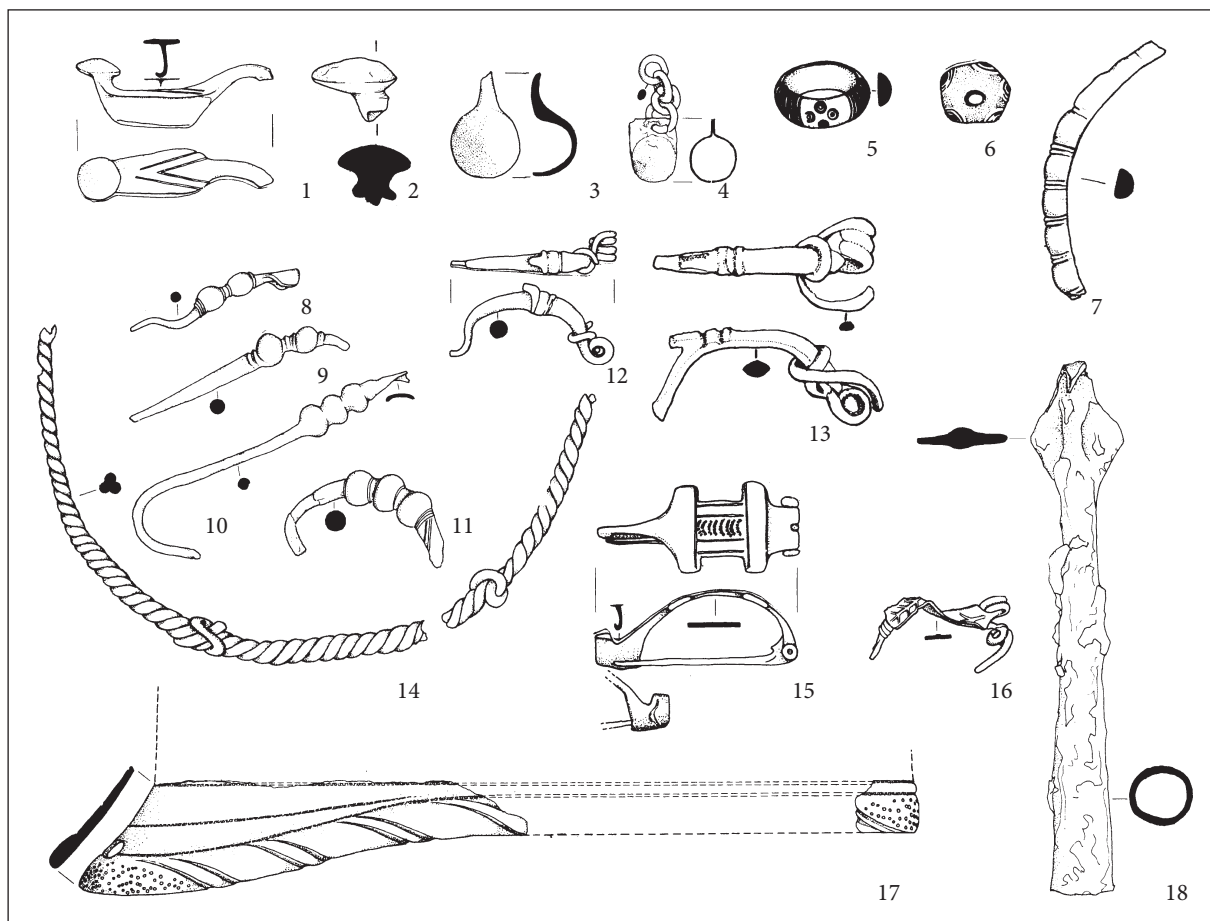

Sl. 6.21: Izbor najdb s kultnega mesta na Kovačevšu nad Lokavcem. 6 steklo, 15 medenina in železo, 16 medenina, 18 železo, drugo bron. M. = 1:2 (Svoljšak 1983, t. 1–6).

Fig. 6.21: Selection of finds from the cult place at Kovačevše above Lokavec. 6 glass, 15 brass and iron, 16 brass, 18 iron, others bronze. Scale = 1:2 (Svoljšak 1983, Pls. 1–6).

in orožje (med drugim dele bronaste etruščansko-italske čelade in železne sulične osti). Neposredno povezavo z najdbami s Tonovcovega gradu (sl. 6.2) predstavljajo noga certoške fibule z dvojnimi V-motivom na hrbtu, polovica votlega kroglastega obeska, steklena jagoda s plastovitimi modro-belimi očesci, zapognjeni nogi fibul vrste Idrija pri Bači, lok slovenske vrste fibul s tremi vozli na loku in fibula vrste Jezerine brez noge (sl. 6.21: 1, 3, 6, 8, 9, 11, 16).

Pri izkopavanjih rimskega podeželskega dvorca na Kolenovci pri Lokah v spodnji Vipavski dolini je bilo najdenih tudi nekaj bronastih predmetov, od katerih sta dva (prstan in del negovske čelade) zanesljivo, trije dvojni obroči pa verjetno iz pozne halštatske dobe<sup>10</sup> (sl. 6.22 – Žbona-Trkman 1985, 104, sl. 3; Vidrih Perko, Žbona Trkman 2003–2004, 23, op. 8). Prstan D-preseka, okrašen s krožci s piko (sl. 6.22: 1), je podoben prsta-

<sup>10</sup> Predmete mi je izročila za risanje in mi dovolila njihovo objavo kustosinja Goriškega muzeja v Kromberku pri Novi Gorici Beatrice Žbona Trkman, za kar se ji najlepše zahvaljujem.

also Svolljšak's data that the filling of the pit contained also partly burned bones and pieces of burnt remains.<sup>9</sup> Metal and glass finds are with the exception of one strongly profiled fibula (Svolljšak 1983, Pl. 1: 23) from the Iron Age. Fragments of pottery vessels (e.g. pieces of jugs and terra sigillata) are, however, mostly from the Roman period (ibid., 8). Finds from the Early and Late Iron Age comprise fibulae, annular jewellery, glass beads, pendants, and weaponry (among others also parts of a bronze Etrusco-Italic helmet and iron spearheads). The direct connection to the finds from Tonovcov grad (Fig. 6.2) is represented by a foot of the Certosa fibula with double V-motif on the back, a half of a hollow globular pendant, a glass bead with layered blue and white eyes, two bent feet of the Idrija pri Bači fibula type, a bow of the Slovenian type of fibulae with three knobs on the bow, and a fibula of the Jezerine type without the foot (Fig. 6.21: 1, 3, 6, 8, 9, 11, 16).

<sup>9</sup> The data about the partly burnt bones and pieces of burnt remains is given by Svolljšak only in the Slovenian text (1983, 9) and is omitted in the very short Italian summary.

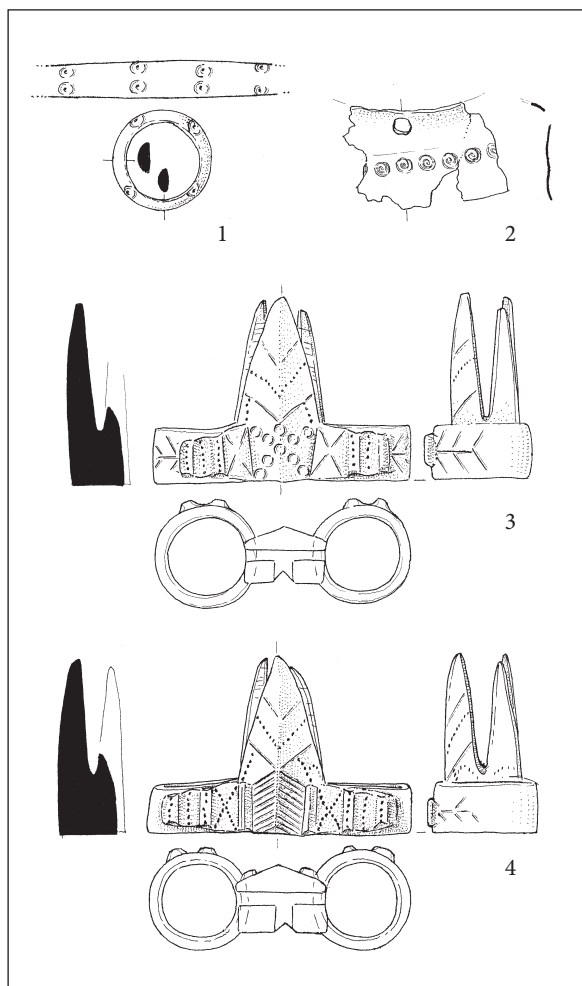

Sl. 6.22: Izbor najdb z domnevnega kulnega mesta na Kolenovci pri Lokah. Vse bron. M. = 1:2.

Fig. 6.22: Selection of finds from the presumed cult place at Kolenovca near Loke. All bronze. Scale = 1:2.

nu s Kovačevša (sl. 6.21: 5), odlomek podloge krajcev negovske čelade (sl. 6.22: 2) je primerljiv z odlomkom štule s Tonovcovega gradu (sl. 6.2: 6), povsem izjemni v Sloveniji pa so trije dvojni obroči z bodicami,<sup>11</sup> dva nepoškodovana (sl. 6.22: 3, 4) in eden poškodovan v ognju, ki so nedvomno italskega izvora (Muffatti 1971, 293–294, *Doppi anelli con cunei*, t. 61b: 1–14; Jacobi 1974, 192–195, *Stachelringe*, t. 53: 818 in 819; Adam 1984, 105–106, *Pièces d'attelage*, kat. št. 119–129; Endert 1991, 74–75, *Stachelring*, t. 22: 384; Sannibale 1998, 222–253, *Anelli gemini cuspidati*; Jurgeit 1999, 178–180, *Zwillingsringe*, kat. št. 256–259; Schönfelder 2002, 273–275, *Stachelringe*, Fig. 173, Tab. 48).

<sup>11</sup> V dražbenem katalogu Mecklenburške zbirke je bil en tak dvojni obroč, ki v resnici menda izvira iz severne Italije (Jacobi 1974, 195, op. 846), pomotoma uvrščen med najdbe z različnih najdišč na Kranjskem (Mahr 1934, 81, lot 30, t. 7: 30; Schönfelder 2002, 275, tab. 48 je zmešnjavo še povečal, ko je zemljepisno ime Carniola prevedel kot Koroška [“Kärnten”] namesto kot Kranjska!).

During the excavations of the Roman villa rustica at Kolenovca near Loke in the lower Vipava Valley a few bronze items were found, among which two (a ring and a part of a Negova helmet) are certainly, and three double rings are probably from the final Hallstatt period<sup>10</sup> (Fig. 6.22 – Žbona-Trkman 1985, 104, Fig. 3; Vidrih Perko, Žbona Trkman 2003–2004, 23, note 8). The ring of the D-cross section decorated by ring-and-dots (Fig. 6.22: 1) is similar to the ring from Kovačevše (Fig. 6.21: 5), the fragment of the Negova helmet brim lining (Fig. 6.22: 2) is comparable to the cap fragment from Tonovcov grad (Fig. 6.2: 6), completely exceptional in Slovenia are three double rings with spines,<sup>11</sup> two of which are undamaged (Fig. 6.22: 3, 4) and one damaged in the fire, all of which are certainly of Italic origin (Muffatti 1971, 293–294, *Doppi anelli con cunei*, Pl. 61b: 1–14; Jacobi 1974, 192–195, *Stachelringe*, Pl. 53: 818 and 819; Adam 1984, 105–106, *Pièces d'attelage*, cat. nos. 119–129; Endert 1991, 74–75, *Stachelring*, Pl. 22: 384; Sannibale 1998, 222–253, *Anelli gemini cuspidati*; Jurgeit 1999, 178–180, *Zwillingsringe*, cat. nos. 256–259; Schönfelder 2002, 273–275, *Stachelringe*, Fig. 173, Tab. 48). These bronze finds from Kolenovca near Loke, which is located in the immediate vicinity of the picturesque spring of the torrent Lijak (Žbona-Trkman 1985, 103), most probably originate from an Iron Age offering place near the villa.

#### 6.4.3 ŠENTVIŠKA PLANOTA PLATEAU

In the Posočje area the remains of Iron Age sanctuaries or cult places are known, beside from the valleys of the Soča and Vipava, also from the Šentviška planota plateau between the rivers Bača and Idrijca. From numerous metal finds, which were discovered by the unauthorised searchers at Berlotov rob near Šentviška Gora, only very few have been published until today, among them a fragment of a final Hallstatt bronze situla (Turk P. et al. 2009, 57–59, Figs. 10–11), a torc from the Late La Tène period (Turk P. 2006b, 99, Fig. 78: 5; Božič 2007, 837, Fig. 7), and two fibulae of Alesia type (Istenič 2005, 192, cat. no. 5, Fig. 2, Pl. 1: 5; 196, cat. no. 12, Fig. 6, Pl. 1: 12).

That a cult place was located also at Vrh gradu near Pečine (Fig. 6.23 – Božič 1999b, 75, Figs. 5 and 6; Laha-

<sup>10</sup> These items were handed over for drawing and were allowed to be published by me by the curator of the Goriški muzej in Kromberk near Nova Gorica Beatriče Žbona Trkman, for which I am very grateful.

<sup>11</sup> In the auction catalogue of the Mecklenburg collection one such double ring was listed which is supposed to originate from northern Italy (Jacobi 1974, 195, note 846) and was by mistake classified among the finds from various sites in Carniola (Mahr 1934, 81, lot 30, Pl. 7: 30; Schönfelder 2002, 275, Tab. 48 only added to the confusion when he translated the geographical name Carniola as Kärnten [“Koroška”] instead of Krain [“Kranjska”]).



2002, 273–275, Stachelringe, sl. 173, tab. 48). Te bronaste najdbe s Kolenovce pri Lokah, ki leži v neposredni bližini slikovitega izvira hudourniškega Lijaka (Žbona-Trkman 1985, 103), zelo verjetno izvirajo z železnodobnega daritvenega mesta v bližini dvorca.

### 6.4.3 ŠENTVIŠKA PLANOTA

V Posočju so ostanki železnodobnih svetišč oziroma kulturnih mest razen iz dolin Soče in Vipave znani še s Šentviške planote med rekama Bačo in Idrijco. Od številnih kovinskih najdb, ki so jih nepooblaščenim iskalci odkrili na Berlotovem robu pri Šentviški Gori, jih je bilo doslej objavljenih zelo malo, med njimi odlomek poznohalštatske bronaste situle (Turk P. et al. 2009, 57–59, sl. 10–11), ovratnica iz pozne latenske dobe (Turk P. 2006a, 99, sl. 78: 5; Božič 2007, 837, sl. 7) in fibuli vrste Alezija (Istenič 2005, 206, kat. št. 5, sl. 2, t. 1: 5; 208, kat. št. 12, sl. 6, t. 1: 12).

Da je bilo kulturno mesto tudi na Vrh gradu pri Pečinah (sl. 6.23 – Božič 1999b, 75, sl. 5 in 6; Laharnar, Mlinar 2011), dokazuje tukaj najdena daritvena ploščica iz srebra z venetskim napisom (sl. 6.17: 2 – Mlinar, Crevatin 2011). Na podlagi primerjav z drugimi kulturnimi mesti pa bi smeli med kultne darove uvrstiti tudi polovico votlega kroglastega obeska (prim. sl. 6.23: 2 s sl. 6.3: 4 in 6.21: 3), odlomek certoške fibule (prim. sl. 6.23: 1 s sl. 6.21: 1), zapognjeno nogo fibule s tremi odebelitvami blizu objemke (prim. sl. 6.23: 3 s sl. 6.21: 10) ter fibulo vrste Jezerine brez noge<sup>12</sup> (prim. s sl. 6.21: 16). Obročasta fibula vrste Posočje (sl. 6.23: 4 – Cunja, Mlinar 2010, 112, kat. št. 115) iz stopnje LT D (Guštin 1991, 40, sl. 6: 9; 10: 10; 20: 4) pa po tem, da je cela, ustreza fibuli vrste Alezija s kulturnega mesta na Kovačevšu (sl. 6.21: 15 – Cunja, Mlinar 2010, 115, kat. št. 134), ki je prav tako poznolatska, iz stopnje LT D2.

<sup>12</sup> Tolminski muzej v Tolminu je leta 2011 pridobil več najdb s tega najdišča, med njimi slabo ohranjeno nogo certoške fibule, del zapognjene noge fibule s tremi odebelitvami in poškodovano objemko (sl. 6.23: 3) ter fibulo vrste Jezerine brez noge.

rnar, Mlinar 2011) is proven by the here found offering plate made of silver with a Venetic inscription (Fig. 6.17: 2 – Mlinar, Crevatin 2011). On the basis of comparisons with other cult places we can assign among the cult offerings also the half of a hollow globular pendant (cf. Fig. 6.23: 2 to Figs. 6.3: 4 and 6.21: 3), a fragment of a Certosa fibula (cf. Fig. 6.23: 1 to Fig. 6.21: 1), a bent foot of a fibula with three thickenings near the clasp (cf. Fig. 6.23: 3 to Fig. 6.21: 10), and a fibula of the Jezerine type without the foot<sup>12</sup> (cf. to Fig. 6.21: 16). The annular fibula of the Posočje type (Fig. 6.23: 4 – Cunja, Mlinar 2010, 112, cat. no. 115) from phase LT D (Guštin 1991, 40, Figs. 6: 9; 10: 10; 20: 4) in the fact that it is complete corresponds to the fibula of the Alesia type from the cult place Kovačevše (Fig. 6.21: 15 – Cunja, Mlinar 2010, 115, cat. no. 134), which is also Late La Tène, from phase LT D2.

### 6.4.4 FRIULI

At the northern slope of the western part of Monte di Medea above Medea, 15 km west of Gorizia, in 1968 under the supervision of Ugo Furlani on the area of about 10 m<sup>2</sup> mostly in brown-blackish loam layer, approximately 700 bronze fragments were excavated (Fig. 6.24), around 60 % of which belong to Certosa fibulae of variant IXa and type X according to Teržan (Furlani 1974-1975, Pls. 2; 3; 4: 1-22; Teržan 1976, 329-336, appendix 1). In this layer and also above and below it numerous tiny pieces of burnt bones were found, which were according to Furlani human (Furlani 1974-1975, 35). Besides the bronze finds 80 glass beads were also discovered (Fig. 6.24: 16, 17 – *ibid.*, 38, Pl. 5: 21-33, 36-38) and a very large number of small fragments of pottery vessels (*ibid.*, 37-38, Pl. 6). Bronze finds include also fragments of annular jewellery (Fig. 6.24: 18-20 – *ibid.*, 37, Pl. 5: 1-9) and several rings, among them such

<sup>12</sup> Tolminski muzej in Tolmin acquired several finds from this site in 2011, among them also a poorly preserved foot of a Certosa fibula, a piece of a bent fibula foot with three thickenings and a damaged clasp (Fig. 6.23: 3), and a fibula of the Jezerine type without the foot.

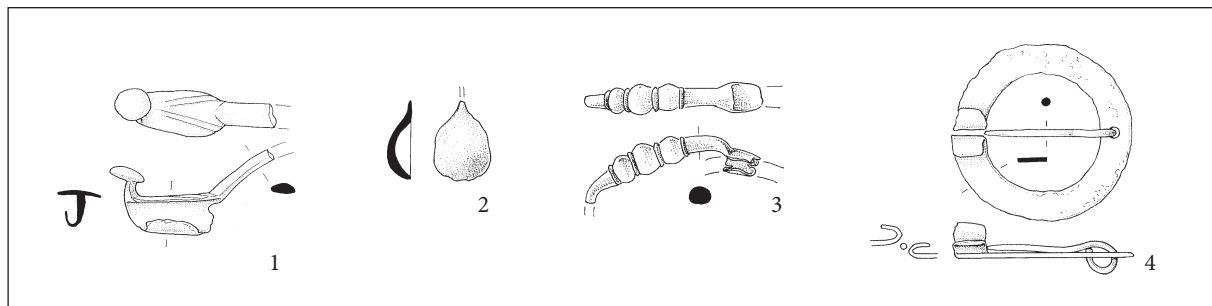

Sl. 6.23: Izbor najdb s kulturnega mesta na Vrh gradu pri Pečinah. Vse bron. M. = 1:2 (1, 2 in 4 Božič 1999b, sl. 5).

Fig. 6.23: Selection of finds from the cult place at Vrh gradu near Pečine. All bronze. Scale = 1:2 (1, 2 and 4 Božič 1999b, Fig. 5).

Sl. 6.24: Izbor najdb s kulnega mesta na Medejskem hribu nad Medejo. 16 in 17 steklo, drugo bron. M. = 1:2 (Furlani 1974–1975, t. 2–5).

Fig. 6.24: Selection of finds from the cult place at Monte di Medea above Medea. 16 and 17 glass, others bronze. Scale = 1:2 (Furlani 1974–1975, Pls. 2–5).

#### 6.4.4 FURLANIJA

Na severnem pobočju zahodnega dela Medejskega hriba (it. Monte di Medea) nad Medejo (it. Medea) 15 km zahodno od Gorice je bilo leta 1968 pod vodstvom Uga Furlanija na površini okrog 10 m<sup>2</sup> predvsem v rjavočrnikiasti ilovnati plasti izkopanih okrog 700 bronastih odlomkov (sl. 6.24), od katerih jih je okrog 60 % sodilo k certoškim fibulam različice IXa in X. vrste po Teržanovi (Furlani 1974–1975, t. 2; 3; 4: 1–22; Teržan 1976, 329–336, pril. 1). V tej plasti, pa tudi nad njo in pod njo je bilo zelo veliko drobnih koščkov sežganih kosti, po Furlaniju človeških (Furlani 1974–1975, 35). Razen bronastih najdb so odkrili še 80 steklenih jagod (sl. 6.24: 16, 17 – prav tam, 38, t. 5: 21–33, 36–38) in zelo veliko majhnih odlomkov keramičnih posod (prav tam, 37–38, t. 6). Bronaste najdbe obsegajo še odlomke obročastega nakita (sl. 6.24: 18–20 – prav tam, 37, t. 5: 1–9) ter več obročkov, med njimi take s šestimi izrastki, ki so drugače kot fibule večinoma celi (sl. 6.24: 14, 15 – prav tam, 36–37, t. 4: 23–28). Večina bronastih odlomkov in vse steklene jagode so bili izpostavljeni delovanju ognja (prav tam, 35–36 in 38). Furlani je domneval, da gre za uničeno žgano grobišče (prav tam, 38). Pri tej domnevi je vztrajal tudi še potem, ko je postalo jasno, da se moti (Furlani 2000, 38–47).

Šestnajst let po izidu Furlanijevega članka je namreč Anne-Marie Adam (1991, 52–60) prepričljivo pokazala, da ima "grobišče" na Medejskem hribu številne podobnosti z žgalnodaritvenimi mesti, ki so značilna zlasti za tista območja Alp, kjer so po antičnih pisnih virih prebivali Retijci (prav tam, 56–59). Po njenem mnenju Furlani na Medejskem hribu ni raziskal ostankov žganega grobišča, ki so ga uničili pri terasiranju pobočja, ampak kratkotrajno kultno mesto s konca starejše železne dobe (prav tam, 53–54 in 58). Do iste ugotovitve je prišel neodvisno od Adamove tudi Paul Gleirscher (2002, 175, sl. 1: 117; 187, levi stolpec; 244, kat. št. 117).

#### 6.4.5 NOTRANJSKA

Najdbam s kulnega mesta na Medejskem hribu v Furlaniji so izredno podobne najdbe s Starega gradu pri Uncu na Notranjskem, ki so jih našli iskalci kovin in se zdaj hranijo v Vojnem muzeju Logatec v Gornjem Logatcu (Gaspari 2009, 318, sl. 4). Gre za odlomke certoških

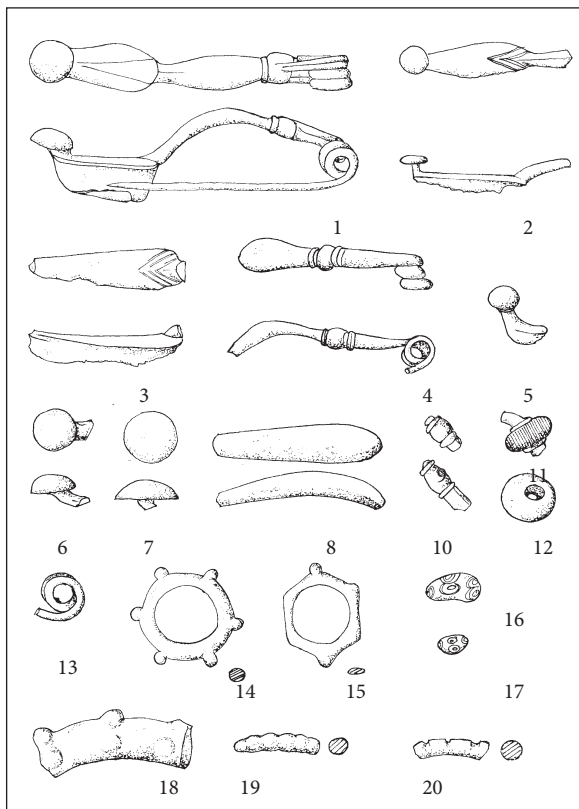

with six knobs, which are, unlike the fibulae, mostly complete (Fig. 6.24: 14, 15 – *ibid.*, 36–37, Pl. 4: 23–28). Most of the bronze fragments and all glass beads were exposed to fire (*ibid.*, 35–36 and 38). Furlani assumed that this is a destroyed cremation cemetery (*ibid.*, 38). He insisted on this assumption even after it had been proven wrong (Furlani 2000, 38–47).

Namely, sixteen years after Furlani's article was published Anne-Marie Adam (1991, 52–60) convincingly proved that the 'cemetery' at Monte di Medea has numerous similarities with the burnt-offering sites which are primarily characteristic for those areas of the Alps where according to the ancient written sources the Raetian people lived (*ibid.*, 56–59). According to her opinion, Furlani at Monte di Medea did not research the remains of a cremation cemetery, destroyed during the terracing of the slope, but a short-lasting cult place from the end of the Early Iron Age (*ibid.*, 53–54 and 58). Independently of Adam the same conclusion was reached also by Paul Gleirscher (2002, 175, Fig. 1: 117; 187, left column; 244, cat. no. 117).

#### 6.4.5 NOTRANJSKA REGION

Finds from the cult place at Monte di Medea in Friuli are extraordinarily similar to the finds from Stari grad near Unec in Notranjska, which were found by the metal searchers and are now kept at the Vojni muzej

fibul in obročastega nakita ter za cele obročke, od katerih sta dva okrogla, drugi pa imajo po pet ali šest izrastkov. Te najdbe nakazujejo, da je bilo na koncu halštatske dobe tukaj kultno mesto, ki je bilo sodeč po dveh odlomkih poznolatskih ščitnih grb (prav tam, 326, op. 103, sl. 6: 6, 7) v rabi vse do pozne latenske dobe.<sup>13</sup>

#### 6.4.6 KARNIJA

Še eno pomembno kultno mesto je bilo odkrito na jugozahodnem pobočju hriba Monte Sorantri nad Raveom v Karniji (Concina 2001, 57, kat. št. 7, Santuario (?); Villa 2001, 101, op. 6, sl. 5; Righi 2001, 114–119, sl. 7–20; Donat, Righi, Vitri 2007, 100–108, sl. 12–19; Faleschini et al. 2009, 150, sl. 3). Zanj je značilno, da sodi samo v latensko dobo in da so med darovanimi predmeti samo orožje (meča, nožnice, sulični osti, sulična kopita, ost piluma, naličnice čelad, ščitne grbe, ročaji in žeblički ščitov), železne fibule, dve zajemalki in štirje kavljji (sl. 6.25). Celi so samo nekatera kopita, en pasni obroček, nekaj žebličkov ščitov in trije kavljji, vse drugo pa je bolj ali manj poškodovano oziroma razkosano. Zato je Giuliano Righi upravičeno sklepal, da so potekali tukaj v latenski dobi obredi, povezani s svetom vojne (Righi 2001, 119–121).

#### 6.4.7 ŽELEZNODOBNO KULTNO MESTO NA TONOVCOVEM GRADU PRI KOBARIDU

Predstavljena svetišča in kultna mesta iz železne dobe na območju Posočja, Karnije, Furlanije in Notranjske (sl. 6.20) po mojem mnenju krepijo domnevo, da drobne najdbe iz železne dobe, odkrite na Tonovcovem gradu (sl. 6.2), izvirajo z nekega kultnega mesta na tem hribu, ki je po sestavi najdb še najbližje kultnima mestoma na Kovačevšu nad Lokavcem v zgornji Vipavski dolini (sl. 6.21) in na Vrh gradu pri Pečinah na Šentviški planoti (sl. 6.17: 2; 6.23).

Podrobna primerjava med kultnim mestom na Tonovcovem gradu in svetiščem na Gradiču nad Kobaridom na tem mestu ni mogoča. Omenim naj samo, da so na Gradiču močno zastopani predmeti italškega izvora (na primer del bronastih kipcev, ki predstavljajo rimske bogove, darovalce in svečenika, amfore, keramika s črnim premazom in keramični askosi) in keramične posode različnih vrst (Osmuk 1997, 12 in 14; Mlinar 2011a, 22–23), kar vse na Tonovcovem gradu manjka.

<sup>13</sup> Boštjan Laharnar me je ljubeznivo opozoril, da je med najdbami s Starega gradu, ki jih hranijo v Narodnem muzeju Slovenije v Ljubljani, tudi neobjavljen konicnik nožnice latenskega meča iz stopnje LT B2 (inv. št. G 11133), ki bi tako kot malo mlajši konicnik s Tonovcovega gradu (sl. 6.2: 8) lahko izviral s kultnega mesta.

Logatec in Gornji Logatec (Gaspari 2009, 318, Fig. 4). These are fragments of Certosa fibulae and annular jewellery and complete rings, among which two are round and the others have five or six knobs. These finds indicate that a cult place was located here at the end of the Hallstatt period which was, judging from two fragments of the Late La Tène shield bosses (ibid., 326, note 103, Fig. 6: 6, 7), in use all to the Late La Tène period.<sup>13</sup>

#### 6.4.6 CARNIA

Another important cult place was discovered at the southwestern slope of the hill Monte Sorantri above Raveo in Carnia (Concina 2001, 57, cat. no. 7, Santuario (?); Villa 2001, 101, note 6, Fig. 5; Righi 2001, 114–119, Figs. 7–20; Donat, Righi, Vitri 2007, 100–108, Figs. 12–19; Faleschini et al. 2009, 150, Fig. 3). It is characteristic for this site that it belongs exclusively to the La Tène period and that the offering items include only weaponry (two swords, scabbards, two spearheads, spearbutts, a pilum head, helmet cheek-pieces, shield bosses, shield handles and nails), iron fibulae, two ladles, and four hooks (Fig. 6.25). Only some butts, one belt ring, a few shield nails, and three hooks are complete, everything else is more or less damaged or torn to pieces. Thus Giuliano Righi justifiably assumed that during the La Tène period rituals connected to the world of warfare were performed here (Righi 2001, 119–121).

#### 6.4.7 IRON AGE CULT PLACE AT TONOVCOV GRAD NEAR KOBARID

The presented sanctuaries and cult places from the Iron Age in the Posočje area, Carnia, Friuli, and Notranjska (Fig. 6.20) in my belief strengthen the assumption that the small finds from the Iron Age discovered at Tonovcov grad (Fig. 6.2) originate from a cult place at this hill which is according to the find composition nearest to cult places Kovačevše above Lokavec in the upper Vipava Valley (Fig. 6.21) and Vrh gradu near Pečine at the Šentviška planota plateau (Figs. 6.17: 2; 6.23).

A detailed comparison between the cult place at Tonovcov grad and the sanctuary at Gradič above Kobarid is here not possible. Let me just mention that at Gradič there is a strong representation of the items of Italic origin (e.g. some of the bronze statuettes representing Roman gods, offerers and a priest, amphorae, black-slipped ware, and pottery *askoi*) and pottery ves-

<sup>13</sup> Boštjan Laharnar kindly drew my attention to the fact that among the finds from Stari grad, kept at the Narodni muzej Slovenije in Ljubljana, there is also an unpublished chape of a La Tène sword from phase LT B2 (inv. no. G 11133) which could like the slightly later chape fragment from Tonovcov grad (Fig. 6.2: 8) originate from a cult place.

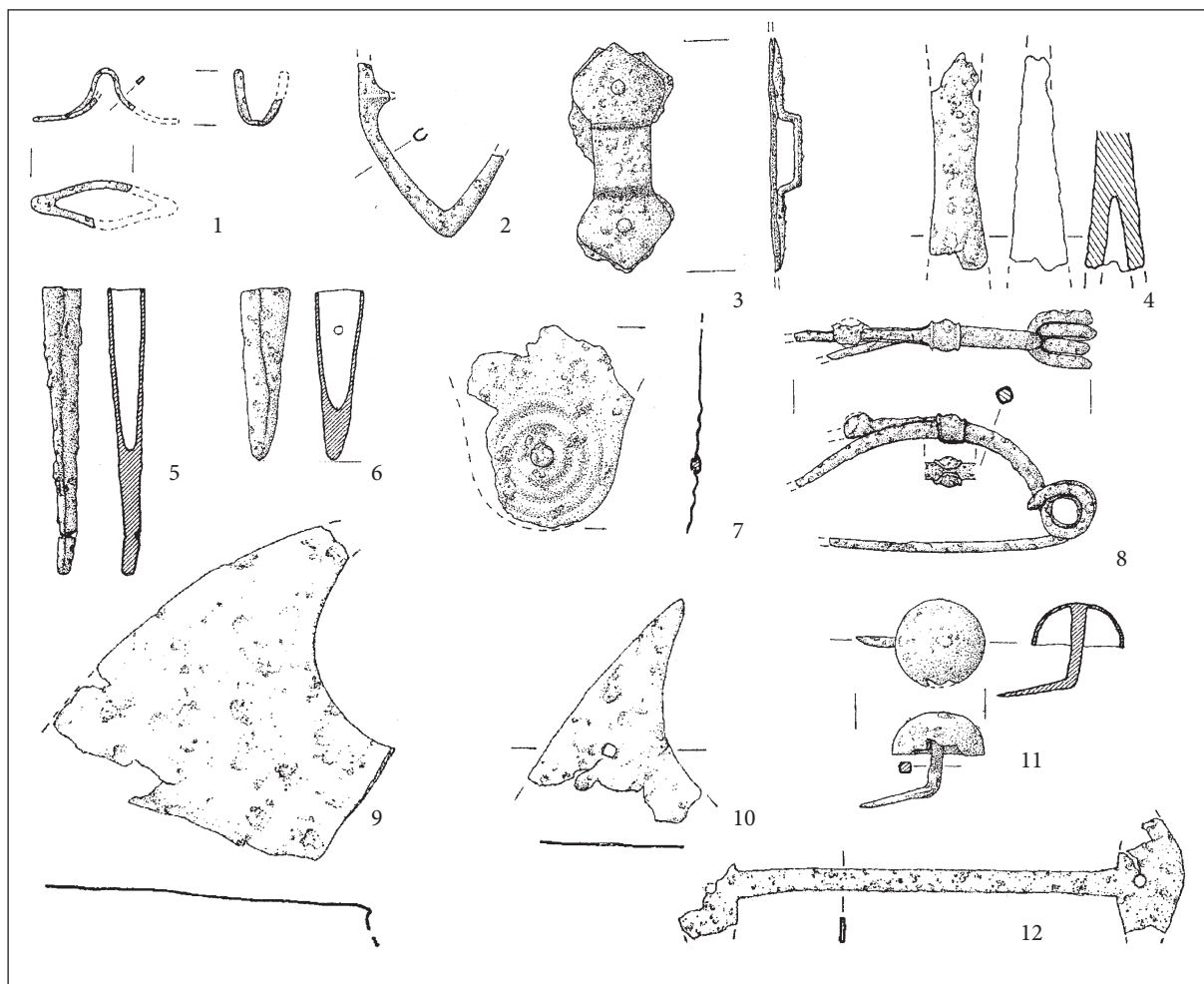

Sl. 6.25: Izbor najdb s kultnega mesta na Monte Sorantri nad Raveom. Vse železo. Različna merila (Righi 2001, sl. 7, 10–16 in 19).  
Fig. 6.25: Selection of finds from the cult place at Monte Sorantri above Raveo. All iron. Various scales (Righi 2001, Figs. 7, 10–16, and 19).

Po drugi strani pa imamo tukaj dele orožja, ki jih med najdbami na Gradiču ni.

Glede treh odlomkov orožja (čelade, meča in nožnice – sl. 6.2: 6, 10 in 8) in obročaste pasne sponke z jezičkom, ki je bila del vojaškega pasu (sl. 6.2: 9), zadošča omeniti, da so na Kolenovci pri Lokah tudi našli odlomek negovske čelade (sl. 6.22: 2), na Kovačevšu nad Lokavcem dele etruščansko-italske (sl. 6.21: 17) in še ene čelade (Svoljšak 1983, 20, kat. št. 42) in na dveh karnijskih kulturnih mestih, na Monte Sorantri nad Raveom (sl. 6.25: 7 – Righi 2001, 116–117, sl. 12: 37–38; 13: 39–42) ter na Colle Mazéit pri Verzegnisu (Vannacci Lunazzi 2001, 154, sl. 5: 3; Donat, Righi, Vitri 2007, 98, sl. 10: 3), naličnice keltskih čelad. Braniki keltskih mečev in zaključki koničnikov nožnic so znani s kultnega mesta na Monte Sorantri (sl. 6.25: 1, 2 – Righi 2001, sl. 7: 2; 10: 9; 14: 46–48) in z žgalnodaritvenega mesta Rungger Egg na Južnem Tirolskem (Gleirscher 2002, t. 54: 6, 10–13). Na zadnjem najdišču sta bili najdeni tudi obročasti pasni sponki s hruškastim jezičkom in gumbom na poševnem

sels of different types (Osmuk 1997, 12 and 14; Mlinar 2011b, 22–23), all of which are missing from Tonovcov grad. On the other hand, here we find parts of weaponry absent among the finds from Gradič.

Regarding the three fragments of weaponry (helmet, sword, and scabbard – Fig. 6.2: 6, 10, and 8) and the annular belt hook with a tongue that was part of a military belt (Fig. 6.2: 9) it should suffice to say that at Kolenovca near Loke a fragment of a Negova helmet was also found (Fig. 6.22: 2), at Kovačevše above Lokavec parts of an Etrusco-Italic (Fig. 6.21: 17) and another helmet (Svoljšak 1983, 20, cat. no. 42) and at two Carnian cult places, Monte Sorantri above Raveo (Fig. 6.25: 7 – Righi 2001, 116–117, Figs. 12: 37–38; 13: 39–42) and Colle Mazéit near Verzegnis (Vannacci Lunazzi 2001, 154, Fig. 5: 3; Donat, Righi, Vitri 2007, 98, Fig. 10: 3), cheek-pieces of Celtic helmets. Guards of Celtic swords and chape ends are known from the cult place at Monte Sorantri (Fig. 6.25: 1, 2 – Righi 2001, Figs. 7: 2; 10: 9; 14: 46–48) and from burnt-offering site Rungger Egg in

vratu (prav tam, t. 55: 11, 12), podobni poškodovani pasni sponi s Tonovcovega gradu (*sl.* 6.2: 9).

Opravljen podrobna analiza 19 železnodobnih najdb s Tonovcovega gradu (*sl.* 6.2) je okrepila domnevo, da je bilo tu v starejši in mlajši železni dobi kulturno mesto. Prvi jo je kot eno od več možnih razlag predstavil Slavko Ciglencečki (1997, 7–8), za njim pa sta jo kot najverjetnejšo možnost navedla najprej Tina Milavec v svoji disertaciji<sup>14</sup> in za njo še Miha Mlinar v vodniku po stalni razstavi Tolminskega muzeja.<sup>15</sup>

### Zahvala

Za pomoč pri pripravi članka se lepo zahvaljujem Mateji Belak, Dragici Knific Lunder, Zvezdani Modrijan in Dragu Valohu z našega inštituta, Tini Milavec z Oddelka za arheologijo Filozofske fakultete v Ljubljani, Boštjanu Laharnarju, Idi Murgelj in Petru Turku iz Narodnega muzeja Slovenije v Ljubljani, Darji Pirkmajer iz Pokrajinskega muzeja v Celju, Mariji Ogrin in Vereni Vidrih Perko iz Gorenjskega muzeja v Kranju, Beatriče Žbona Trkman iz Goriškega muzeja v Kromberku, Marku Gregu in Mihi Mlinarju iz Tolminskega muzeja v Tolminu, Marzii Vidulli iz Mestnih zgodovinskih in umetnostnih muzejev v Trstu in Markusu Eggu iz Rimsko-germanskega osrednjega muzeja v Mainzu. Lepa hvala tudi Jani Horvat z našega inštituta, ki je natančno prebrala prvotno in precej skrajšano različico članka in mi dala več koristnih predlogov in pripomb.

<sup>14</sup> Milavec 2008, 5: "Spekter najdb iz starejše in mlajše železne dobe (fibule, jagode, odlomki orožja, votivna tablica – t. 1) nakazuje možnost, da se je na Tonovcovem gradu nahajalo svetišče, podobno kot na sosednjem najdišču, Sv. Antonu nad Gradičem (sic). Posebno zgovorna je bronasta okrašena votivna ploščica, kateri lahko najdemo primerjave na Sv. Antonu in na primer na Gurini (Osmuk 1997, 12; Jablonka 1992, Taf. 196)."

<sup>15</sup> Mlinar 2011a, 23: "Vloge starega kulta ni izničilo niti zgodnjekrščansko središče na bližnjem Tonovcovem gradu, kjer se je glede na spekter nekaterih najdb iz železne dobe (votivna ploščica, fibule, jagode, orožje) morda nahajalo že predkrščansko svetišče."

## 6.5 KAMNITI ARTEFAKTI S TONOVCOVEGA GRADU

Litični inventar, pridobljen med arheološkimi izkopavanji na Tonovcovem gradu med letoma 1994 in 2005, šteje 20 kosov. Izmed njih lahko takoj izločimo dve razbitini roženca, ki glede na obliko in slabo kakovost surovine najverjetneje nista produkt človeškega posega. Prav tako lahko izločimo razbit prodnik peščenjaka, uporabnega kot tolkač ali brus, ki na ohranjenem delu ne kaže nobenih znakov uporabe.

South Tyrol (Gleirscher 2002, Pl. 54: 6, 10–13). At the latter site two annular belt hooks with a pear-shaped tongue and a button on the inclined neck were found (*ibid.*, Pl. 55: 11, 12), which are similar to the damaged belt hook from Tonovcov grad (*Fig.* 6.2: 9).

The performed detailed analysis of 19 Iron Age finds from Tonovcov grad (*Fig.* 6.2) supported the assumption that a cult place was located here in the Early and Late Iron Age. Slavko Ciglencečki (1998, 7–8) was the first to present this as one of the multiple possible explanations and it was later given as the most probable option also by Tina Milavec in her doctoral thesis<sup>14</sup> and then by Miha Mlinar in the guide through the permanent exhibition of Tolminski muzej.<sup>15</sup>

### Acknowledgements

I give my thanks for the help during the preparation of this article to Mateja Belak, Dragica Knific Lunder, Zvezdana Modrijan, and Drago Valoh from our Institute, Tina Milavec from the Oddelka za arheologijo, Filozofska fakulteta Univerze v Ljubljani, Boštjan Laharnar, Ida Murgelj, and Peter Turk from the Narodni muzej Slovenije in Ljubljana, Darja Pirkmajer from the Pokrajinski muzej in Celje, Marija Ogrin and Verena Vidrih Perko from the Gorenjski muzej in Kranj, Beatriče Žbona Trkman from the Goriški muzej in Kromberk, Marko Grego and Miha Mlinar from the Tolminski muzej in Tolmin, Marzia Vidulli from the Civici Musei di Storia ed Arte in Trieste, and Markus Egg from the Römisch-Germanisches Zentralmuseum in Mainz. Kind thanks also to Jana Horvat from our Institute who thoroughly read the original and the considerably shortened version of the article and provided several useful comments and suggestions.

<sup>14</sup> Milavec 2008, 5: "The spectrum of finds from the Early and Late Iron Age (fibulae, beads, weapon fragments, votive plate – Pl. 1) indicates the possibility that a sanctuary was located at Tonovcov grad, similar to the one on the neighbouring site Sv. Anton above Gradič (sic). Especially revealing is the bronze ornamented votive plate, for which comparisons can be found at Sv. Anton and e.g. at Gurina (Osmuk 1997, 12; Jablonka 1992, Taf. 196)."

<sup>15</sup> Mlinar 2011b, 23: "The role of the old cult was not annihilated even by the early Christian centre on the nearby Tonovcov grad, where there might already have existed a pre-Christian temple, with respect to the spectrum of certain findings (sic) from the Iron Age (votive plaquettes, fibulae, beads, and weapons)."

## 6.5 STONE ARTEFACTS FROM TONOVCOV GRAD

The lithic inventory acquired during the archaeological excavations at Tonovcov grad between 1994 and 2005 includes 20 pieces. Two chert shatters, which are – considering the shape and poor quality of the raw material – most probably not the product of human hands, can be immediately excluded. A shattered sandstone pebble could be used as a hammer or a whetstone, but does not show any signs of use on the preserved part and can also be excluded.

Edino glajeno orodje predstavlja fragment kladi-vaste sekire z luknjo, izdelane iz zelenkaste magmatske kamnine (sl. 6.1: 1). Pri ostalih primerkih gre za odbitkovne artefakte iz roženca. Njihova surovinska slika je dokaj enotna, prevladuje kakovostni svetlo sivi roženec. Med odpadnimi produkti, ki nastanejo pri izdelavi kamnitih orodij, je zastopanih pet odbitkov, robni odbitek (sl. 6.1: 11) in jedro. Korteks na robnem odbitku, nožu z naravnim hrbtom in na jedru kaže, da so kot surovino uporabili prodnike roženca. Na majhnem, močno izrabljenem jedru so vidni sledovi odbijanja klinic (sl. 6.1: 12).

Med odbitkovnimi artefakti prepoznamo naslednja orodja: nož z naravnim hrbtom (sl. 6.1: 2), neenakokrak trapez (sl. 6.1: 3), obojestransko ploskovno retuširano puščično ost (sl. 6.1: 4), konico (sl. 6.1: 5), strgalce (sl. 6.1: 6), sveder (sl. 6.1: 7), odbitek z izjedo (sl. 6.1: 8), retuširan klinast odbitek (sl. 6.1: 9) ter retuširan odbitek, ki bi ga zaradi enakomerne okrcanosti vseh robov lahko šteli za kresilnik (sl. 6.1: 10).

V tako majhni zbirki kamnitega inventarja s Tonovcovega gradu najdemo tipe orodij, ki so značilni za različna obdobja kamene dobe oziroma prazgodovine. Izpostavili bomo tri. Na prvem mestu velja omeniti nož z naravnim hrbtom (sl. 6.1: 2), ki je značilno orodje srednjega paleolitika. Delovni rob orodja, izdelanega na masivnem odbitku z gladkim talonom, je v celoti retuširan z uporabno retušo. Visoko starost tega orodja bi lahko nakazovala tudi precejšnja površinska preperelost.

Neenakokraki trapez, izdelan z mikrovbadalno tehniko (sl. 6.1: 3), se je uporabljal kot puščična ost za lok. Neenakokraki trapezi, izdelani z mikrovbadalno tehniko, so značilni za mlajši mezolitik, pojavljajo pa se tudi še v neolitiku. Večje število takšnih trapezov poznamo v Sloveniji iz kraške jame Mala Triglavca pri Divači (Turk M., Turk I. 2004, 187), kjer je plast z mezolitskimi najdbami opredeljena v mlajši mezolitik (*castelnovien*). Za kamnita orodja s Tonovcovega gradu je bila nekoč že zapisana domneva o pripadnosti mezolitiku in/ali mlajšim obdobjem (Ciglencečki 1997, 5–6). Domneva o pripadnosti vsaj dela kamnitih orodij s Tonovcovega gradu mezolitiku ostaja aktualna, še posebej, ker je bilo v zadnjem desetletju v bližnjih gorah nad Sočo odkritih več mezolitskih postaj na prostem (Turk M. et al. 2005; Turk M. 2006). Te so bile na podlagi tipološke analize kamnitih orodij sicer pripisane starejšemu mezolitiku (*sauveterrien*).

V še mlajše prazgodovinsko obdobje uvrščamo, skupaj s kladi-vasto sekiro, obojestransko ploskovno retuširano puščično ost (sl. 6.1: 4). Takšne puščične osti se pojavljajo vse od mlajšega neolitika do bronaste dobe. V našem primeru jo v povezavi s kladi-vasto sekiro datiramo v eneolitik.

Kamnite najdbe so bile odkrite v vseh odkopanih stavbah (stavbe 1, 2 in 3, sklop cerkva in cisterna), po večini v plasti trde oranžnordeče ilovice, ki je ponekod

The only polished tool is represented by a fragment of a hammer axe with a hole, made of a greenish magma rock (Fig. 6.1: 1). Other pieces are knapped artefacts made of chert. The knapped artefact raw material picture is fairly simple, in it the quality light grey chert prevails. Among waste products, which occur during the manufacturing of stone tools, there are five flakes, a cortical flake (Fig. 6.1: 11), and a core. The cortex on the cortical flake, on the naturally backed knife, and on the core reveals that chert pebbles were used as the raw material. Traces of bladelet flaking are visible on the small, strongly reduced core (Fig. 6.1: 12).

The following tools are recognised among the knapped artefacts: a naturally backed knife (Fig. 6.1: 2), an asymmetrical trapeze (Fig. 6.1: 3), a bifacially retouched arrow point (Fig. 6.1: 4), a point (Fig. 6.1: 5), a raclette (Fig. 6.1: 6), a borer (Fig. 6.1: 7), a notch (Fig. 6.1: 8), a retouched laminar flake (Fig. 6.1: 9), and a retouched flake which could be, on the account of the even chipping of all edges, considered a firestone (Fig. 6.1: 10).

Such a small collection of stone inventory from Tonovcov grad reveals types of tools which are typical of various Stone Age or prehistoric periods. We should stress three. Firstly we should mention the naturally backed knife (Fig. 6.1: 2) which is a typical tool of the Middle Palaeolithic. The working edge of the tool, made on the massive flake with a smooth striking platform, is completely retouched with a use wear retouch. The significant surface weathering could also indicate great age of this tool.

The asymmetrical trapeze made by the microburin technique (Fig. 6.1: 3) was used as an arrow point for the bow. Asymmetrical trapezes made by the microburin technique are characteristic of the Late Mesolithic and appear also during the Neolithic. In Slovenia many such trapezes are known from the Karst cave Mala Triglavca near Divača (Turk M., Turk I. 2004, 187) where the layer with the Mesolithic finds is assigned to its later phase (*castelnovien*). An assumption that the stone tools from Tonovcov grad belong to the Mesolithic and/or later periods has once already been written (Ciglencečki 1997, 5-6). The assumption that at least some of the stone tools from Tonovcov grad belong to the Mesolithic remains relevant, especially because in the last decade in the nearby mountains above the Soča several Mesolithic open sites were discovered (Turk M. et al. 2005; Turk M. 2006). These sites were on the basis of the stone tool typological analysis assigned to the Early Mesolithic (*sauveterrien*).

The bifacially retouched arrow point (Fig. 6.1: 4) is together with the hammer axe assigned to the later period of prehistory. Such arrow points appear from the Late Neolithic to the Bronze Age. In our case it is in connection to the hammer axe dated to the Eneolithic.

Stone finds were discovered in all unearthed buildings (buildings 1, 2, and 3, the ecclesiastical complex, and the cistern), mostly in the layer of firm orange-red loam

vsebovala drobce slabo ohranjene, nedoločljive prazgodovinske keramike (glej Tonovcov grad. Naselbinski ostanki in interpretacija, pogl. 2.2.1). Pod to zadnjo kulturno plastjo je bila plast sterilne oranžne ilovice, ki je ležala na skalni osnovi. Meja med obema ilovnatima plastema je bila pogosto težko določljiva. Ker so graditelji antičnih objektov med gradnjo gotovo posegali v globlje plasti, je bilo nekaj kamnitih najdb odkritih tudi v antičnih plasteh. Največ kamnitih najdb je bilo pobranih v izkopnem polju stavb 2 in 3, ki sta umeščeni na sedlo med platojem s cerkvami in najvišjim vrhom Tonovcovega gradu (glej Tonovcov grad. Naselbinski ostanki in interpretacija, pogl. 2.4 in 3.2). V stavbi 3 sta bila v plasti trde oranžnordeče ilovice (SE 140 = 180) najdena nož z naravnim hrbtom in obojestransko ploskovno retuširana puščična ost. V isti stavbi je bil v sivi kulturni plasti (SE 172), ki je ležala pod antičnim zidom, najden neenakokraki trapez. Kamnita sekira je bila najdena v stavbi 2.

Glede na hribovit teren, prepreden s številnimi kotanjami in sedli, ugotavljamo, da najstarejše najdbe s Tonovcovega gradu niso bile odkrite v primarni legi. Drsenje najdb s pobočij in njihovo odlaganje v kotanjah, kjer so se akumulirali ali formirali tudi ilovnati sedimenti, antični gradbeni posegi ter nejasna razmejitev med sterilno in kulturno ilovnato plastjo nam otežujejo stratifikacijo in interpretacijo kamnitih najdb. Vsekakor bo treba pri novih izkopavanjih usmeriti pozornost na najgloblje plasti, ne samo v antičnih stavbah, temveč tudi zunaj njih.

*Matija TURK*

which in places contained pieces of poorly preserved indefinable prehistoric pottery (see Tonovcov grad. Settlement remains and interpretation, chapter 2.2.1). Beneath this last cultural layer a layer of sterile orange loam was covering the rocky base. The border between both loam layers is often difficult to define. Since the builders of the Antique buildings during construction certainly reached into deeper layers, some stone finds were discovered also in the Antique layers. Most of the stone finds were gathered in the excavation field of buildings 2 and 3, which are located at the pass between the plateau of the ecclesiastical complex and the highest point of Tonovcov grad (see Tonovcov grad. Settlement remains and interpretation, chapters 2.4 and 3.2). In building 3, a naturally backed knife and a bifacially retouched arrow point were found in the layer of firm orange-red loam (SU 140 = 180). In the same building an asymmetrical trapeze was found in the grey cultural layer (SU 172), which lay beneath the Antique wall. The stone axe was found in building 2.

Considering the hilly terrain intersected by numerous depressions and passes we believe that the earliest finds from Tonovcov grad were not discovered in their primary position. The stratification and interpretation of stone finds is made difficult by the sliding of finds along hills and their deposition in the depressions where loam sediments also accumulated and formed, by the Antique building interventions, and the unclear delimitation between the sterile and cultural loam layer. With the new excavations, the attention should be focused on the deepest layers, not only within the Antique buildings but also outside.

*Matija TURK*

## 6.6 KATALOG / CATALOGUE

### *Sl. 6.1*

1. Fragment glajene kladivaste sekire z luknjo, zelenkasta magmatska kamnina, inv. št. 23566. Stavba 2, SE 140=180.

– Milavec, Modrijan 2007, 110, op. 3, sl. 3: 3.

2. Nož z naravnim hrbtom, preperel rumenosiv roženec, uporabna retuša vzdolž celotnega desnega roba, gladek talon, inv. št. 23583. Stavba 3, SE 140=180.

3. Neenakokraki trapez, svetlosiv roženec, inv. št. 23588. Stavba 3, SE 172.

4. Obojestransko ploskovno retuširana puščična ost, temno siv roženec, inv. št. 23565. Stavba 3, SE 140 = 180.

– Milavec, Modrijan 2007, 110, op. 3, sl. 3: 2.

5. Konica, svetlosiv roženec, gladek talon, inv. št. 23456. Sklop cerkva - "memorija", SE 19.

– Ciglencečki 1997, 30, prva vrsta.

– Milavec, Modrijan 2007, 110, op. 3, sl. 3: 1.

6. Strgalce, svetlosiv roženec, inv. št. 22440. Stavba 1, SE 39.

7. Sveder, svetlosiv roženec, inv. št. 22385. Stavba 1, SE 66.

– Ciglencečki 1997, 6 s sl. in 30, prva vrsta.

8. Odbitek z izjedo, rjav roženec, korteks, inv. št. 23390. Stavba 1, SE 17.

9. Retuširan klinast odbitek, temnosiv roženec, inv. št. 23587. Stavba 3, SE 172.

10. Retuširan odbitek (kresilnik?), svetlosiv roženec, inv. št. 23580. Stavba 3, SE 144.

11. Robni odbitek, siv roženec, inv. št. 23652. Sklop cerkva - osrednja cerkev, sonda 2, SE 46.

12. Jedro na prodniku, siv roženec, korteks, inv. št. 23680. Cisterna, SE 201.

### *Sl. 6.2*

1. Votel kroglast obesek, bron, ohr. v. 2,9 cm, pr. 1,9 cm, inv. št. 22367. Ohranjena je polovica. Okrašena je bila s štirimi rombično razporejenimi krožci s piko. Ker je patina skoraj v celoti odpadla, so zdaj vidne samo še pike. Stavba 1, kv. 668/B1, SE 24.

– Ciglencečki 1997, 30, druga vrsta.

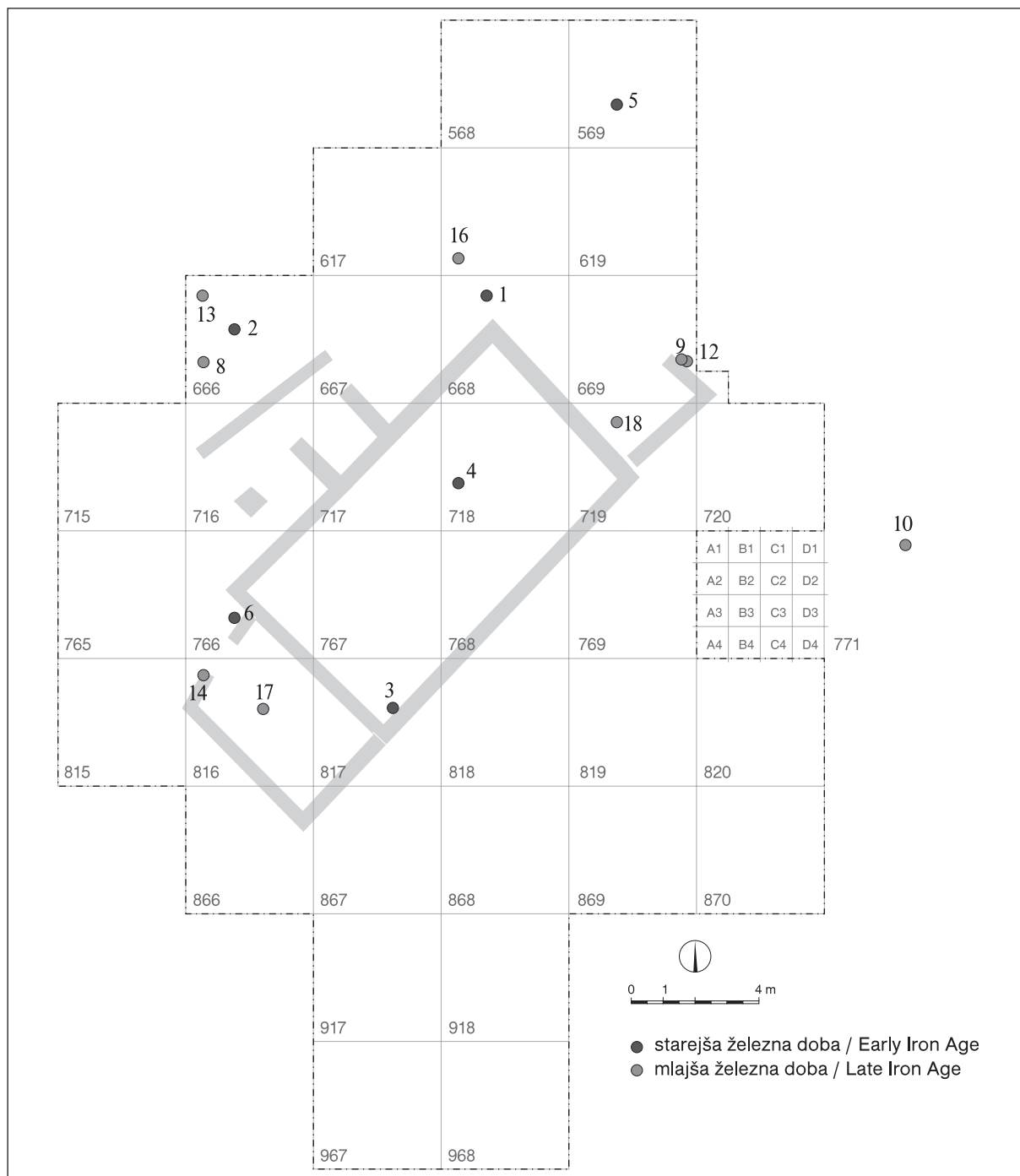

Sl. 6.26: Razprostranjenost železnodobnih najdb v izkopnem polju stavbe 1. M. = 1:200.

Fig. 6.26: Distribution of the Iron Age finds in the excavation area of building 1. Scale = 1:200.

2. Obroček s šestimi izrastki, bron, pr. 3 cm, inv. št. 22322. Izrastki so izraziti in imajo približno pravokoten obris z izbočeno zunanjo stranico. Stavba 1, kv. 666/B2, SE 29? (plast ni zanesljiva, najdeno ob podiranju drevesa).

– Ciglencečki 1997, 30, druga vrsta.

3. Trortasta fibula vrste IIa po Ogrinovi, bron, ohr. d. 2,2 cm, inv. št. 22202. Ohranjen je srednji del loka z odebelitvijo okroglega preseka, ki je spodaj stisnjena, s tremi kroglastimi gumbi, od katerih je dobro ohranjen samo zgornji, in z delom

loka, ki je rombičnega preseka. Stranska gumba sta od odebelitve ločena s po enim svitkom. Stavba 1, kv. 817/C2, SE 21.

– Ciglencečki 1997, 30, druga vrsta.

– Milavec, Modrijan 2007, 110, op. 4, sl. 4: 1.

4. Sploščeno kroglasta jagoda s plastovitimi očesci, modrozeleno steklo, pr. 1,2 cm, inv. št. 22311. Okrašena je s štirimi dvojnimi plastovitimi modro-belimi očesci približno ovalne oblike. Vsako očesce je sestavljeno iz štirih plasti, dveh belih in dveh kobaltno modrih. Stavba 1, kv. 718/A3, SE 10.



5. Certoška fibula, bron, ohr. d. 2,4 cm, inv. št. 22480. Ohranjena je noga brez gumba. Na hrbtu strešastega preseka je okrašena z dvojnimi V-motivom. Stavba 1, kv. 569/B3, SE 34.

– Milavec, Modrijan 2007, 110, op. 5.

6. Negovska čelada, bron, ohr. v. 5,5 cm, deb. 1,5 mm, inv. št. 22835. Ohranjen je del štule z okrasnim frizom iz štirih palmet, ob katerih so slabo vidni ostanki treh dvojnih koncentričnih krožcev. Palmete imajo zaobljen vrh, rahlo izbočena robova in gosta poševna rebra. Stavba 1, kv. 766/ B3, SE 14.

– Milavec, Modrijan 2007, 110–111, op. 7, sl. 4: 2.

7. Obroček s šestimi izrastki, bron, pr. 2,8 cm. Pet izrastkov je neizrazitih. Najden je bil pred izkopavanji z detektorjem kovin. Založen.

– Ciglencečki 1994, 6, t. 2: 6.

– Ciglencečki 1997, 31, tretja vrsta.

8. Nožnica latenskega meča, železo, ohr. v. 5,2 cm, inv. št. 22900. Ohranjeni so zaključek koničnika in kratka dela robnih okovov. Kraka zaključka imata na zgornjem koncu po eno diskasto razširitev in nad njo še odebelitev. Zaključek višine 4 cm je zdaj nesimetričen, ker je bil levi krak potisnjen navznoter. Ohranjenost je slaba. Stavba 1, kv. 666/A3, SE 56.

9. Obročasta pasna spona z jezičkom in gumbom, železo, ohr. d. 2,8 cm, inv. št. 23121. Od okroglega obroča sta ohranjena samo nastavka, slabo je ohranjen tudi gumb na poševnem vratu. Stavba 1, kv. 669/ D3, SE 06.

10. Branik latenskega meča, železo, ohr. d. 5 cm, inv. št. 23178. Slabo ohranjen in skažen. Stavba 1, kv. 771/C1, SE 34.

11. Fibula srednjelatenske sheme vrste Idrija pri Bači, bron, ohr. d. 4,1 cm, inv. št. 22489. Ohranjena je samo zapognjena noga. Na njej sta ena večja in ena manjša kroglasta odebelitev, ki sta na vsaki strani obdani s po enim svitkom. Na koncu izrastka je ostanek objemke, nasprotni konec pa je priostren. Najdena je bila pred izkopavanji z detektorjem kovin.

– Ciglencečki 1994, 5, t. 1: 1.

12. Fibula srednjelatenske sheme vrste Idrija pri Bači, bron, ohr. d. 3,9 cm, inv. št. 22212. Ohranjena je samo zapognjena noga. Na njej sta ena večja in ena manjša kroglasta odebelitev, ki sta na vsaki strani obdani s po enim svitkom. Na koncu izrastka je ostanek objemke, nasprotni konec pa je priostren. Stavba 1, kv. 669/D3, SE 06.

13. Fibula slovenske vrste fibul srednjelatenske sheme s tremi vozli na loku in z okroglo ploščico na zapognjeni nogi,

bron, ohr. d. 3,5 cm, inv. št. 22201. Ohranjen je del loka s tremi vozli in koničasto glavo, ki je v zgornjem delu kvadratnega preseka. Med vozli in na vrhu glave so oglati svitki. Oba svitka med vozli sta okrašena s tankimi prečnimi vrezi. Stavba 1, kv. 666/A1, SE 29.

– Ciglencečki 1997, 30, tretja vrsta.

– Milavec, Modrijan 2007, 110, op. 6, sl. 4: 3.

14. Pravokotna ploščica, bron, vel. 2,9 x 3,9 cm, inv. št. 22219. Iz tanke pločevine izdelana ploščica je delno poškodovana. V vseh štirih vogalih je imela po eno vbito okroglo luknjico. Ob stranicah je okrašena s pasovi, ki so sestavljeni iz niza vtolčenih pik med dvema nizoma iztočenih pik. Notranjost je okrašena z motivom v obliki črke X, ki je sestavljen iz niza iztolčenih pik med dvema nizoma vtolčenih pik. Pri desnem spodnjem kraku en niz vtolčenih pik manjka. Pod luknjico v desnem zgornjem vogalu je še ena nekoliko manjša izbita luknjica. Stavba 1, kv. 816/A1, SE 14.

– Ciglencečki 1997, 8 s sl. na str. 7 in 31, tretja vrsta.

15. Fibula vrste Almgren 65, bron, ohr. d. 2,8 cm, inv. št. 22882. Ohranjen je samo del okviraste noge. Ležišče za iglo je J-preseka. Na notranji strani leve stranice okvirja je neizrazit trikoten izrastek. Zgornja stranica je bila v preseku verjetno rombična. Zunaj izkopnega polja stavbe 1, kv. 513/B1.

16. Fibula vrste Almgren 65, bron, ohr. d. 2,8 cm, inv. št. 22478. Ohranjeni sta glava in polovica peresovine, ki je imela šest navojev in zunanjo tetivo. Ob robu glave poteka ozek žlebič. Stavba 1, kv. 618/A4, SE 06.

– Ciglencečki 1997, 30, tretja vrsta.

17. Fibula vrste Jezerine IIb po Demetzu, bakrova zlitina, ohr. d. 2,9 cm, š. loka 1,2 cm, inv. št. 22332. Ohranjen je del loka, okrašen s tremi rebri. Na srednjem so drobni prečni vrezi. Stavba 1, kv. 816/C2, SE 12.

18. Fibula vrste Jezerine IIa po Demetzu, bakrova zlitina, ohr. d. 2,5 cm, š. loka 0,8 cm, inv. št. 23746. Ohranjena sta razčlenjena objemka in del loka, ki ima na spodnji strani sredinsko rebro. Bila je v ognju. Stavba 1, kv. 719/B1, SE 24.

– Milavec 2009, 244, op. 76, t. 2: 10.

19. Fibula vrste Jezerine IIa po Demetzu, bakrova zlitina, ohr. d. 2,2 cm, š. loka 0,7 cm. Ohranjena sta del loka s sredinskim rebrom na spodnji strani in del peresovine iz štirih navojev in s spodvito tetivo. Najdena je bila pred izkopavanji z detektorjem kovin. Založena.

– Ciglencečki 1994, 5, op. 13, t. 1: 2.

## 6.7 LITERATURA / BIBLIOGRAPHY

Tonovcov grad. Naselbinski ostanki in interpretacija / Tonovcov grad. Settlement remains and interpretation = Ciglencečki, Modrijan, Milavec 2011.

ADAM, A.-M. 1984, *Bronzes étrusques et italiques*. – Paris.

ADAM, A.-M. 1991, Traces de lieux de culte de l'Age du Fer en Frioul. – *Antichità Altoadriatiche* 37, 45–69.

ADAM, A. M. 1996, *Le fibule di tipo celtico nel Trentino*. – Patrimonio storico artistico del Trentino 19.

BATAILLE, G. 2001, Les agrafes de ceinturon du sanctuaire de La Villeneuve-au-Châtelot (Aube). – *Archäologisches Korrespondenzblatt* 31/3, 443–460.

BLEČIČ KAVUR, M. 2009, Universal and Original. Transformation of style in the North-Adriatic Region. – V / In: G. Tiefengraber, B. Kavur in / and A. Gaspari (ur. / eds.), *Keltske študije / Studies in Celtic Archaeology 2, Papers in honour of Mitja Guštin*, Protohistoire Européenne 11, 197–208.

BLEČIČ KAVUR, M. 2010, *Željezno doba na Kvarneru*. – Neobjavljena doktorska disertacija / Unpub-

lished doctoral thesis, Oddelek za arheologijo, Filozofska fakulteta Univerze v Ljubljani, Ljubljana.

BOŽIČ, D. 1983, Oborožitev bojevnikov mlajše železne dobe. – V / In: *Kelti. Kelti in njihovi sodobniki na ozemlju Jugoslavije*, 77–82, Ljubljana.

BOŽIČ, D. 1993, O latenskih najdbah na območju Ptuj. – V / In: B. Lamut (ur. / ed.), *Ptujski arheološki zbornik ob 100-letnici muzeja in Muzejskega društva*, 189–204, Ptuj.

BOŽIČ, D. 1999a, Die Erforschung der Latènezeit in Slowenien seit Jahr 1964 / Raziskovanje latenske dobe na Slovenskem po letu 1964. – *Arheološki vestnik* 50, 189–213.

BOŽIČ, D. 1999b, Tre insediamenti minori del gruppo protostorico di Idrija pri Bači dell'Isontino. – V / In: *Studio e conservazione degli insediamenti minori romani in area alpina*, Studi e Scavi 8, 71–79.

BOŽIČ, D. 2007, Silver Jewellery of Iron Age Women in the Friuli Plain and in the Soča Region. – V / In: *Scripta praehistorica in honorem Biba Teržan*, Situla 44, 829–841.

BOŽIČ, D. 2008, *Late La Tène-Roman cemetery in Novo mesto. Ljubljanska cesta and Okrajno glavarstvo. Studies on fibulae and on the relative chronology of the Late La Tène period / Poznatlatsko-rimsko grobišče v Novem mestu. Ljubljanska cesta in Okrajno glavarstvo. Študije o fibulah in o relativni kronologiji pozne latenske dobe.* – Katalogi in monografije 39.

BOŽIČ, D. 2009, A Hallstatt grave containing a cuirass, excavated near Stična by the Duchess of Mecklenburg in 1913. The reliability of grave groups from the Mecklenburg Collection / K halštatskemu grobu z oklepom, ki ga je leta 1913 pri Stični izkopala vojvodinja Mecklenburška. O zanesljivosti grobnih celot Mecklenburške zbirke. – *Arheološki vestnik* 60, 63–95.

BOŽIČ, D. 2010, Zum Panzergrab von Stična und der Verlässlichkeit der Grabzusammenhänge in der Sammlung Mecklenburg. – *Acta Praehistorica et Archaeologica* 42, 155–172.

BUORA, M. in / and S. SEIDEL (ur. / eds.) 2008, *Fibule antiche del Friuli.* – Cataloghi e Monografie Archeologiche dei Civici Musei di Udine 9.

CIGLENEČKI, S. 1994, Poznoantična naselbina Tonovcov grad pri Kobaridu. – *Kronika* 42/1, 1–14.

CIGLENEČKI, S. 1997, *Tonovcov grad pri Kobaridu. Arheološko najdišče. Vodnik.* – Ljubljana, Kobarid.

CIGLENEČKI, S. 1998, *Tonovcov grad near Kobarid. An archaeological site. A Guide.* – Ljubljana, Kobarid.

CIGLENEČKI, S., Z. MODRIJAN in / and T. MILAVEC 2011, *Poznoantična utrjena naselbina Tonovcov grad pri Kobaridu. Naselbinski ostanki in interpretacija / Late Antique fortified settlement Tonovcov grad near Kobarid. Settlement remains and interpretation.* – Opera Instituti Archaeologici Sloveniae 23.

CONCINA, E. 2001, Contributo alla carta archeologica della Carnia: ritrovamenti dal neolitico all'età del

ferro. – V / In: S. Vitri in / and F. Oriolo (ur. / eds.), *I Celti in Carnia e nell'arco alpino centro orientale*, 51–84.

CREVATIN, F. 2001, Le iscrizioni venetiche del Friuli. – V / In: G. Bandelli in / and F. Fontana (ur. / eds.), *Iulium Carnicum. Centro alpino tra Italia e Norico dalla protostoria all'età imperiale*, Studi e ricerche sulla Gallia Cisalpina 13, 115–125.

CRISMANI, A. in / and G. RIGHI 2002, Le sepolture protostoriche e il catalogo dei materiali. – V / In: Vidulli Torlo 2002, 63–88.

CUNJA, R. in / and M. MLINAR (ur. / eds.) 2010, *S fibulo v fabulo. Fibule iz Istre, s Krasa, iz Notranjske in Posočja med prazgodovino in zgodnjim srednjim vekom / Con la fibula nella storia. Fibule dall'Istria, dal Carso, dalla Carniola Interna e dall'Isontino tra preistoria e alto medioevo.* – Koper / Capodistria.

DEMETZ, S. 1999, *Fibeln der Spätlatène- und frühen römischen Kaiserzeit in den Alpenländern.* – Frühgeschichtliche und provinzialrömische Archäologie. Materialien und Forschungen 4.

DIZDAR, M. 2007, Bikonični lonci sa stepeničasto raščlanjenim ramenom s groblja Zvonimirovo-Veliko polje / Biconical pots with a stepped shoulder from the Zvonimirovo-Veliko polje cemetery. – *Prilozi Instituta za arheologiju u Zagrebu* 24, 121–144.

DONAT, P., G. RIGHI in / and S. VITRI 2007, Pratiche culturali nel Friuli settentrionale tra tarda età del ferro e prima età imperiale. Alcuni esempi (Italia). – V / In: S. Groh in / and H. Sedlmayer (ur. / eds.), *Blut und Wein. Keltisch-römische Kulturpraktiken*, Protohistoire Européenne 10, 91–117.

DULAR, J. 1978, *Podzemelj. Katalog najdb.* – Katalogi in monografije 16.

EGG, M. 1986, *Italische Helme. Studien zu den ältereisenzeitlichen Helmen Italiens und der Alpen.* – Monographien / Römisch-Germanisches Zentralmuseum 11.

ENDERT, D. van 1991, *Die Bronzefunde aus dem Oppidum von Manching. Kommentierter Katalog.* – Die Ausgrabungen in Manching 13.

FALESCHINI, M., G. RIGHI, G. VANNACCI LUNAZZI in / and S. VITRI 2009, La Carnia tra Celti e Romani. Evoluzione dell'insediamento attraverso l'analisi di alcuni siti campione. – *Antichità Altoadriatiche* 68, 147–178.

FREY, O.-H. 1969, *Die Entstehung der Situlenkunst. Studien zur figürlich verzierten Toreutik von Este.* – Römisch-Germanische Forschungen 31.

FURLANI, U. 1974–1975, Una necropoli dell'età del ferro sul Monte di Medea. – *Aquileia Nostra* 45–46, 31–56.

FURLANI, U. 2000, *Medea a il suo colle dalla preistoria alla romanità.* – Medea.

GABROVEC, S. 1960, *Prazgodovinski Bled.* – Dela 1. razreda SAZU 12.

GABROVEC, S. 1966, Srednjelatensko obdobje v Sloveniji. – *Arheološki vestnik* 17, 169–242.

- GABROVEC, S. 1974, Halštatske nekropole v Bohinju. – *Arheološki vestnik* 25, 287–318.
- GABROVEC, S. 1994, *Stična I. Naselbinska izkopavanja / Siedlungsausgrabungen*. – Katalogi in monografije 28.
- GABROVEC, S. 2006, *Stična II/1. Gomile starejše železne dobe / Grabhügel aus der älteren Eisenzeit. Katalog*. – Katalogi in monografije 37.
- GASPARI, A. 2002, *Latenske in zgodnjerske najdbe iz Ljubljane*. – Neobjavljena doktorska disertacija / Unpublished doctoral thesis, Oddelek za arheologijo, Filozofska fakulteta Univerze v Ljubljani, Ljubljana.
- GASPARI, A. 2009, Some Iron Age and Early Roman finds from Stari grad above Unec (Notranjska, Slovenia). – V / In: G. Tiefengraber, B. Kavur in / and A. Gaspari (ur. / eds.), *Keltske študije / Studies in Celtic Archaeology 2, Papers in honour of Mitja Guštin*, Protohistoire Européenne 11, 315–329.
- GHERLIZZA, F. in / and E. HALUPCA 1988, *Spelaeus. Monografia delle grotte e dei ripari sottoroccia del Carso triestino nelle quali sono stati rinvenuti resti di interesse archeologico*. – Trieste.
- GLEIRSCHER, P. 2002, Brandopferplätze in den Ostalpen. – V / In: P. Gleirscher, H. Nothdurfter in / and E. Schubert, *Das Rungger Egg. Untersuchungen an einem eisenzeitlichen Brandopferplatz bei Seis am Schlern in Südtirol*, Römisch-Germanische Forschungen 61, 173–262.
- GUŠTIN, M. 1979, *Notranjska. K začetkom železne dobe na severnem Jadranu / Zu den Anfängen der Eisenzeit an der nördlichen Adria*. – Katalogi in monografije 17.
- GUŠTIN, M. 1987, La Tène fibulae from Istria. – *Archaeologia Jugoslavica* 24, 43–56.
- GUŠTIN, M. 1991, *Posočje. Posočje in der jüngeren Eisenzeit*. – Katalogi in monografije 27.
- GUŠTIN, M. in / and P. EGIDI (ur. / eds.) 2002, Reperti di cultura La Tène. – V / In: *Gli echi della terra. Cultura celtica in Friuli: dati materiali e momenti dell'immaginario. Catalogo*, 53–91.
- HORVAT, J. 1983, Prazgodovinske naselbinske najdbe pri farni cerkvi v Kranju. – *Arheološki vestnik* 34, 140–218.
- HORVAT, J. 1995, Notranjska na začetku rimske dobe: Parti pri Stari Sušici, Ambroževo gradišče in Baba pri Slavini. – *Arheološki vestnik* 46, 177–216.
- ISTENIČ, J. 2005, Brooches of the Alesia group in Slovenia / Fibule skupine Alesia v Sloveniji. – *Arheološki vestnik* 56, 187–212.
- ISTENIČ, J. in / and Ž. ŠMIT 2007, The beginning of the use of brass in Europe with particular reference to the southeastern Alpine region. – V / In: S. La Niece, D. Hook in / and P. Craddock (ur. / eds.), *Metals and Mines. Studies in Archaeometallurgy*, 140–147, London.
- JABLONKA, P. 2001, *Die Gurina bei Dellach im Gailtal. Siedlung, Handelsplatz und Heiligtum*. – Aus Forschung und Kunst 33.
- JACOBI, G. 1974, *Werkzeug und Gerät aus dem Oppidum von Manching*. – Die Ausgrabungen in Manching 5.
- JOSIPOVIČ, D., A. GASPARI in / and A. MIŠKEC 2012, Arheološko najdišče pri cerkvi sv. Janeza Krstnika v Bohinju: preliminarno poročilo o zaščitnih izkopavanjih leta 1999. – V / In: A. Gaspari in / and M. Erič (ur. / eds.), *Potopljena preteklost. Arheologija vodnih okolij in raziskovanje podvodne kulturne dediščine v Sloveniji (1884–2009)*, Ljubljana (v tisku / in press).
- JURGEIT, F. 1999, *Die etruskischen und italischen Bronzen sowie Gegenstände aus Eisen, Blei und Leder im Badischen Landesmuseum Karlsruhe*. – Terra Italia. Collana di studi archeologici sull'Italia antica 5.
- KNEZ, T. 1977, Keltski grobovi iz Roj pri Moravčah. – V / In: M. Guštin (ur. / ed.), *Keltske študije*, Posavski muzej Brežice 4, 105–125.
- KNEZ, T. 1992, *Novo mesto 2, Keltsko-rimsko grobišče / Keltisch-römisches Gräberfeld Beletov vrt*. – Carniola Archaeologica 2.
- KRIŽ, B. 2005, *Novo mesto 6, Mlajšeželeznodobno grobišče / Late Iron Age Cemetery Kapiteljska njiva*. – Carniola Archaeologica 6.
- KUNTER, K. 1995, *Glasperlen der vorrömischen Eisenzeit 4, Schichtaugenperlen*. – Marburger Studien zur Vor- und Frühgeschichte 18.
- LAHARNAR, B. 2009, The Žerovnišček Iron Age hillfort near Bločice in the Notranjska region / Železnodobno gradišče Žerovnišček pri Bločicah na Notranjskem. – *Arheološki vestnik* 60, 97–157.
- LAHARNAR, B. in / and M. MLINAR 2011, K Minervi in Hefajstu na Vrh gradu. – *EPICenter. Glasilo Posoškega razvojnega centra* 12/1–2, 24–25.
- LEJARS, Th. 1994, *Gournay 3, Les fourreaux d'épée. Le sanctuaire de Gournay-sur-Aronde et l'armement des Celtes de La Tène moyenne*. – Paris.
- MAHR, A. (ur. / ed.) 1934, *Prehistoric Grave Material from Carniola excavated in 1905–14 by H. H. the late Duchess Paul Friedrich of Mecklenburg*. – New York.
- MAJNARIČ-PANDŽIČ, N. 2001, Grob ratnika Lt 12 iz srednjolatskog groblja u Zvonimirovu kod Suhopolja u Virovitičko-podravskoj županiji. – *Prilozi Instituta za arheologiju u Zagrebu* 18, 83–101.
- MARCHESETTI, C. 1893, Scavi nella necropoli di S. Lucia presso Tolmino (1885–1892). – *Bollettino della Società adriatica di scienze naturali in Trieste* 15, 2–336.
- MARIČ, Z. 1968, Japodske nekropole u dolini Une. – *Glasnik Zemaljskog muzeja Bosne i Hercegovine u Sarajevu* 23, 5–80.
- MELLER, H. 2002, *Die Fibeln aus dem Reitia-Heiligtum von Este (Ausgrabungen 1880–1916). Studien zu den Spätlatèneformen / Le fibule dal santuario di Reitia a Este (scavi 1880–1916). Studio delle forme del tardo La Tène*. – Studien zu vor- und frühgeschichtlichen Heiligtümern 2.

MILAVEC, T. 2008, *Primerjalna analiza kovinskega gradiva poznoantičnih naselbin vzhodnoalpskega prostora*. – Neobjavljena doktorska disertacija / Unpublished doctoral thesis, Oddelek za arheologijo, Filozofska fakulteta Univerze v Ljubljani, Ljubljana.

MILAVEC, T. 2009, Crossbow fibulae of the 5<sup>th</sup> and 6<sup>th</sup> centuries in the southeastern Alps / Samostrelne fibule 5. in 6. stoletja na jugovzhodnoalpskem prostoru. – *Arheološki vestnik* 60, 223–248.

MILAVEC, T. in / and Z. MODRIJAN 2007, L'abitato tardoantico di Tonovcov grad presso Kobarid alla luce dei reperti ceramici e metallici / Poznoantična naselbina Tonovcov grad v luči keramičnih in kovinskih najdb. – V / In: *Terre d'incontro. Contatti e scambi lungo le Valli del Natisone e dell'Isonzo dall'antichità al medioevo / Kraji srečanj. Stiki in izmenjave vzdolž Nadiških in Soške doline od antike do srednjega veka*, 107–127, Cividale del Friuli.

MLINAR, M. 2002, *Nove Zanke svetolucijske uganke. Arheološke raziskave na Mostu na Soči: 2000 do 2001 / Sveta Lucija - New Stigma to the Enigma. Archaeological excavations at Most na Soči: 2000 - 2001*. – Tolmin.

MLINAR, M. 2004, Srpenica, novoodkrita najdišče svetolucijske skupine. – V / In: *Bovški zbornik. Ob 800-letnici prve pisne omembe župnije Bovec, 1192-1992*, 129–141.

MLINAR, M. 2007, Archeologia nell'Isontino: nuove acquisizioni / Arheologija v Posočju: novi podatki. – V / In: *Terre d'incontro. Contatti e scambi lungo le Valli del Natisone e dell'Isonzo dall'antichità al medioevo / Kraji srečanj. Stiki in izmenjave vzdolž Nadiških in Soške doline od antike do srednjega veka*, 50–66, Cividale del Friuli.

MLINAR, M. 2008, *Most na Soči (Sv. Lucija) – izkopavanja na grobišču 2000-2002*. – Magistrsko delo / MA thesis, Oddelek za arheologijo, Filozofska fakulteta Univerze v Ljubljani, Ljubljana.

MLINAR, M. 2011a, Kobariska kulturna krajina. – V / In: D. Fortunat Černilogar (ur. / ed.), *Naplavine obsoške zgodovine. Vodnik po stalni razstavi Tolminskega muzeja*, 22–23.

MLINAR, M. 2011b, Cult region of Kobarid. – V / In: D. Fortunat Černilogar (ur. / ed.), *The Soča region and its historical deposits. Guide to the permanent exhibition of the Tolmin Museum*, 22–23.

MLINAR, M. in / and F. CREVATIN 2012, Laminetta d'argento con iscrizione venetica proveniente da Vrh gradu sull'altipiano di Šentviška planota in Slovenia occidentale. – V / In: V. Orioles (ur. / ed.), *Miscellanea in memoria di Roberto Gusmani*, Udine (v tisku / in press).

MUFFATTI, G. 1971, Problemi e testimonianze della città etrusca di Marzabotto. 3 - *L'instrumentum in bronzo. Parte III*. – *Studi Etruschi* 39, 267–299.

OGRIN, M. 1998, Trortasta fibula v Sloveniji. – *Arheološki vestnik* 49, 101–132.

OSMUK, N. 1987, Die Bronzeplastik aus Kobarid. Kulturgeschichtliche Bedeutung Kobarider Gruppe

kleiner Bronzeplastik und ein Datierungsversuch. – *Archaeologia Jugoslavica* 24, 57–79.

OSMUK, N. 1988, Črniče, Tabor. – *Varstvo spomenikov* 30, 213.

OSMUK, N. 1997, Kobarid od prazgodovine do antike. Kratek zgodovinski pregled obdobj in pripadajočih najdišč. – V / In: *Kobarid*, 9–16, Kobarid.

OSMUK, N. 1998a, Le sanctuaire protohistorique de Kobarid (Slovénie). – *Instrumentum* 7, 13.

OSMUK, N. 1998b, Plaquette votive de Kobarid (SI), inspirée d'un denier républicain. – *Instrumentum* 7, 17.

PARZINGER, H. 1988, *Chronologie der Späthallstatt- und Frühlatène-Zeit. Studien zu Fundgruppen zwischen Mosel und Save*. – Quellen und Forschungen zur prähistorischen und provinzialrömischen Archäologie 4.

PETTARIN, S. 2006, *Le necropoli di San Pietro al Natisone e Dernazzacco nella documentazione del Museo Archeologico Nazionale di Cividale del Friuli*. – Studi e ricerche di protostoria mediterranea 7.

PIRKMAJER, D. 1991, *Kelti na Celjskem. Arheološka razstava Pokrajinskega muzeja Celje*. – Celje.

RIGHI, G. 2001, I rinvenimenti lateniani di Amaro e di Monte Sorantri a Raveo. – V / In: S. Vitri in / and F. Oriolo (ur. / eds.), *I Celti in Carnia e nell'arco alpino centro orientale*, 113–148.

RUTA SERAFINI, A. (ur. / ed.) 2002, *Este preromana: una città e i suoi santuari*. – Treviso.

SANNIBALE, M. 1998, *Le armi della collezione Gorga al Museo Nazionale Romano*. – *Studia Archaeologica* 92.

SCHÖNFELDER, M. 2002, *Das spätkeltische Wagengrab von Boé (Dép. Lot-et-Garonne). Studien zu Wagen und Wagenrädern der jüngeren Latènezeit*. – Monographien / Römisch-Germanisches Zentralmuseum 54.

SVOLJŠAK, D. 1983, Kovačevše – naselje idrijske skupine v Vipavski dolini. – *Goriški letnik* 10, 5–32.

ŠMIT, Ž., J. ISTENIČ, V. GERDUN, Z. MILIČ in / and A. MLADENVIČ 2005, Archaeometric analysis of Alesia group brooches from sites in Slovenia / Arheometrične analize fibul skupine Alesia s slovenskih najdišč. – V: *Arheološki vestnik* 56, 213–233.

ŠTULAR, B. 2009, *Mali grad. Visokosrednjeveški grad v Kamniku / Mali grad. High medieval castle in Kamnik*. – Opera Instituti Archaeologici Sloveniae 15.

TERŽAN, B. 1976, Certoška fibula. – *Arheološki vestnik* 27, 317–536.

TERŽAN, B. in / and N. TRAMPUŽ 1973, Prispevek h kronologiji svetolucijske skupine. – *Arheološki vestnik* 24, 416–460.

TERŽAN, B., F. LO SCHIAVO in / and N. TRAMPUŽ-OREL 1984, *Most na Soči (S. Lucia) 2, Szombathyjeva izkopavanja. Table / Die Ausgrabungen von J. Szombathy. Tafelband*. – Katalogi in monografije 23/2.

TERŽAN, B., F. LO SCHIAVO in / and N. TRAMPUŽ-OREL 1985, *Most na Soči (S. Lucia) 2, Szom-*

*bathyjeva izkopavanja. Tekst / Die Ausgrabungen von J. Szombathy. Text.* – Katalogi in monografije 23/1.

TOMIČIČ, Ž. in / and M. DIZDAR 2005, Grobovi latenske kulture s Velikog polja u Zvonimirovu – rezultati istraživanja 1993.-1995. / Gräber der La-Tène-Kultur von Veliko Polje in Zvonimirovo – Ergebnisse der Forschungen 1993-1995. – *Prilozi Instituta za arheologiju u Zagrebu* 22, 59–125.

TURK, M. 2006, Mezolitski lovci pod Krnom. – V / In: T. Cevc (ur. / ed.), *Človek v Alpah. Desetletje (1996–2006) raziskav o navzočnosti človeka v slovenskih Alpah*, 71–81, Ljubljana.

TURK, M. in / and I. TURK 2004, Mala Triglavca: Arheološke najdbe / Archaeological Finds. – V / In: I. Turk (ur. / ed.), *Viktorjev spodmol in Mala Triglavca / Viktorjev spodmol and Mala Triglavca*, Opera Instituti Archaeologici Sloveniae 9, 176–196.

TURK M., M. MLINAR, J. TURK, J. BIZJAK in / and P. JAMNIK 2005, Plano mezolitsko najdišče na planini Pretovč. – *Arheološki vestnik* 56, 37–47.

TURK, P. 2006a, Keltski bojovníci. – V / In: T. Nabergoj (ur. / ed.), *Stopinje v preteklost. Zakladi iz arheoloških zbirk Narodnega muzeja Slovenije*, 98–99, Ljubljana.

TURK, P. 2006b, Celtic warriors. – V / In: T. Nabergoj (ur. / ed.), *Steps into the Past. Treasures from the archaeological collections of the National Museum of Slovenia*, 98–99, Ljubljana.

TURK, P., D. BOŽIČ, J. ISTENIČ, N. OSMUK in / and Ž. ŠMIT 2009, New Pre-Roman Inscriptions from Western Slovenia : The Archaeological Evidence. – V / In: G. Tiefengraber, B. Kavur in / and A. Gaspari (ur. / eds.), *Keltske študije / Studies in Celtic Archaeology 2, Papers in honour of Mitja Guštin*, Protohistoire Européenne 11, 47–64.

VANNACCI LUNAZZI, G. 2001, L'insediamento di Colle Mazéit a Verzegnis. – V / In: S. Vitri in / and F. Oriolo (ur. / eds.), *I Celti in Carnia e nell'arco alpino centro orientale*, 149–171.

VIDRIH PERKO, V. in /and B. ŽBONA TRKMAN 2003–2004, Trgovina in gospodarstvo v Vipavski dolini in Goriških Brdih v rimski dobi. Interpretacija na podlagi najdišč Loke, Neblo, Bilje in Ajdovščina. – *Goriški letnik* 30–31, 17–72.

VIDULLI TORLO, M. (ur. / ed.) 2002, *La necropoli di San Servolo. Veneti, Istri, Celti e Romani nel territorio di Trieste.* – Trieste.

VILLA, L. 2001, L'insediamento d'altura in località Monte Sorantri a Raveo: cenni sulle indagini archeologiche e sulle evidenze di età romana. – V / In: S. Vitri in / and F. Oriolo (ur. / eds.), *I Celti in Carnia e nell'arco alpino centro orientale*, 99–111.

WARNEKE, Th. F. 1999, *Hallstatt- und frühlatènezeitlicher Anhängerschmuck. Studien zu Metallanhängern des 8.-5. Jahrhunderts v. Chr. zwischen Main und Po.* – Internationale Archäologie 50.

ŽBONA-TRKMAN, B. 1985, Loke. Villa rustica. – *Arheološki pregled* 26, 103–104.



## 7. ANTROPOLOŠKA ANALIZA SKELETOV

### 7. ANTHROPOLOGICAL ANALYSIS OF THE SKELETONS

Petra LEBEN-SELJAK

#### 7.1 UVOD, MATERIAL IN METODE DE LA

Tonovcov grad je bil poseljen od prazgodovine do srednjega veka. Vrhunec razvoja je dosegel v poznoantičnem obdobju, v ta čas datirajo tudi ostanki naselbine in večina grobov (glej Tonovcov grad. Naselbinski ostanki in interpretacija, pogl. 2.2).

V naselbini je bilo odkritih 22 grobov, vendar sta bila dva prazna (grobova 2 in 14), v dveh pa so bile samo živalske kosti (grobova 16 in 17). Človeških okostij je bilo torej 18, večina izmed njih je bila ohranjena v celoti, vendar so bile kosti v zelo slabem stanju.

Dva skeleta sta po pridatkih iz zgodnjega srednjega veka (grobova 18 in 21, konec 7. do začetka 9. stoletja), glede na lego pa v ta čas sodita tudi grobova 15 in 20, morda pa tudi grob 1a ob stavbi 1. Preostalih 14 skeletov je iz pozne antike, verjetno pripadajo drugi poznoantični fazi na Tonovcovem gradu (konec 5., 6. st.).

Antropološka analiza je izdelana po standardnih metodah. Obsega določitev spola in starosti (Chiarelli 1980, Acsádi, Nemeskéri 1970, Steele 1976), antropometrično morfološko analizo (Martin, Saller 1957), analizo zobovja (Hillson 1996), epigenetskih znakov (Hauser, De Stefano 1989) ter patoloških sprememb na okostjih (Aufderheide, Rodríguez-Martín 1998, Rogers, Waldron 1994, Steinbock 1976). Pri določanju starosti je upoštevana tudi abrazija zob (Brothwell 1972), pri morfološki analizi frontomandibularni indeks (Škerlj, Dolinar 1950), telesna višina pa je izračunana po Manouvrierjevi metodi. V primerih, ko ni bilo mogoče izmeriti dolžine dolge kosti, je bila za oceno njene dolžine uporabljena Müllerjeva rekonstrukcijska formula (Krogman, Işcan 1986).

#### 7.1 INTRODUCTION, MATERIAL AND METHODS

Tonovcov grad was inhabited from prehistoric times all until the Middle Ages. The peak of its development was reached during Late Antiquity, and the settlement remains and most of the graves belong to this period (see Tonovcov grad. Settlement remains and interpretation, chapter 2.2).

The settlement revealed 22 graves, 2 of which were empty (graves 2 and 14), and two contained only animal bones (graves 16 and 17). This means that there were 18 human skeletons, most of which were preserved in entirety, however the bones were in a very poor condition.

Two skeletons were buried together with Early Medieval grave goods (graves 18 and 21, end of the 7<sup>th</sup> to the beginning of the 9<sup>th</sup> century); taking into account the location of graves 15 and 23 it seems that they could also belong into this period, as could grave 1a next to building 1. The remaining 14 skeletons were dated to Late Antiquity, most likely they originated to the Late Antiquity 2 phase (at Tonovcov grad this was the end of the 5<sup>th</sup> and 6<sup>th</sup> century).

Standard methods were used in the anthropological analysis. This includes the assessment of age and sex (Chiarelli 1980, Acsádi, Nemeskéri 1970, Steele 1976), anthropometric morphological analysis (Martin, Saller 1957), dental analysis (Hillson 1996), as well as the study of epigenetic traits (Hauser, De Stefano 1989) and pathological changes on the skeletons (Aufderheide, Rodríguez-Martín 1998, Rogers, Waldron 1994, Steinbock 1976). In the age assessment we also considered dental wear (Brothwell 1972), in the morphological analysis we included the frontal mandibular index (Škerlj, Dolinar 1950), while the stature was calculated according to Manouvrier's method. In the event that it was impossible to measure the length of the long bone its length was assessed with the aid of Müller's reconstruction formula (Krogman, Işcan 1986).

## 7.2 REZULTATI

## 7.2.1 OPIS SKELETOV PO GROBNIH ENOTAH

**Grob 1a**

– moški, juvenis – adultus I, 20 let

Slabo ohranjen skelet: fragmenti lobanje (rekonstrukcija ni mogoča), diafize vseh dolgih kosti okončin (manjka desna ulna), deli reber in loki vretenc.

Spolni znaki na medenici so moški, na lobanji pa mešani (tab. 7.2).

Določitev starosti je okvirna, ker ključni deli okostja niso ohranjeni (*synchondrosis sphaenooccipitalis* in epifize dolgih kosti). *Capitulum radii* in *trochanter minor* sta že prirasla, lobanjski šivi so še povsem odprti. Abrazija zob je zelo rahla (17–25 let), korenine  $M_3$  in  $I_2$  so na apeksu še odprte.

Ohranjenih je 26 zob, 4 zobje so izpadli post mortem, 2 zoba pa manjkata vključno z deli čeljustnic. Abrazija zob je zelo rahla ( $M_1 = 2-3$ ,  $M_2 = 1-2$ ,  $M_3 = 1$ ). Zobje so zdravi, brez kariesa. Rahle obloge zobnega kamna.

Postkranialne kosti so na pogled srednje robustne, za moškega razmeroma gracilne. Mišična narastišča niso izražena. Na levem humerusu je vidna perforacija *fosse olecrani* v velikosti 10 x 6 mm, medtem ko ustrezen del kosti pri desnem humerusu manjka. Dolžina radiusa in tibije je ocenjena na podlagi merljivih fragmentov (radius c-d 19 cm, tibija d-e 18 cm), obe dolžini ustrezata telesni višini 166,6 cm.

**Grob 1**

– moški, matusus II – senilis, 53–62 let

Srednje dobro ohranjen skelet. Manjkajo vratna in prsna vretenca, leva klavikula in levi humerus. Večina postkranialnih kosti je v fragmentih, poškodovan je tudi obrazni del lobanje.

Spolni znaki na medenici in lobanji so tipično moški (tab. 7.2).

Starost je določena po kombinirani metodi ob upoštevanju dveh faktorjev, *facies symphyseos os pubis* (faza III, 46–58 let) in endokranialne obliteracije lobanjskih šivov (koronalni in sagitalni šiv sta popolnoma zarasla, koeficient endokranialne obliteracije je 4,0, faza V, 58–72 let). Abrazija zob je zelo močna (nad 50 let).

Ohranjenih je 13 zob, post mortem je izpadlo 6 zob, 11 zob pa manjka vključno z maksilo. Oba tretja kočnika v madibuli nista izrasla ali pa sta izpadla že pred smrtjo. Zobje so zdravi, brez kariesa. Abrazija zob je zelo močna ( $M_1 = 5+$ ,  $M_2 = 5$ ). Kompenzirana je s kontinuiranim izraščanjem zob, kar se kaže v izpostavljenih zobnih vratovih in koreninah. Razdalja med skleninsko mejo (CEJ) in robom zobne alveole je 5 mm pri kaninih in 7 mm pri molarjih v mandibuli. Znakov parodontalnih obolenj ni.

## 7.2 RESULTS

## 7.2.1 SKELETON DESCRIPTION BY GRAVES

**Grave 1a**

– male, juvenis – adultus I, 20 years

Poorly preserved skeleton: skull fragments (reconstruction is impossible), diaphysis of all long bones (the right ulna is missing), parts of ribs and vertebrae arches.

The sexual traits on the pelvis are male, on the cranium undefined (Table 7.2).

The age assessment is an approximation, as the key parts of the skeleton were not preserved (*synchondrosis sphaenooccipitalis* and the epiphysis of the long bones). *Capitulum radii* and *trochanter minor* have already united, while the cranial suture remained completely open. The degree of dental wear is very mild (17-25 years), and the roots of  $M_3$  and  $I_2$  are still open at the apex.

26 teeth have been preserved, 4 have fallen out post mortem, while 2 teeth are missing together with parts of the jawbones. Dental wear is very mild ( $M_1 = 2-3$ ,  $M_2 = 1-2$ ,  $M_3 = 1$ ). The teeth are healthy, no traces of dental caries. Slight calculus.

The postcranial bones appear to be moderately robust, relatively gracile for a male. The muscle attachment areas are not pronounced. There is a *fosse olecrani* perforation measuring 10 x 6 mm on the left humerus, while the same part of the bone of the right humerus is missing. The lengths of the radius and tibia were estimated on the basis of the measurable fragments (radius c-d 19 cm, tibia d-e 18 cm); both lengths correspond to a body height of 166.6 cm.

**Grave 1**

– male, matusus II – senilis, 53-62 years

Average preserved skeleton. The cervical and thoracic vertebrae, the left clavicle and the left humerus are missing. Most postcranial bones are fragmented and the facial part of the cranium is also damaged.

Sexual traits on the pelvis and the cranium are typically male (Table 7.2).

The age was estimated with the use of a combined method that took two factors into account, i.e. *facies symphyseos os pubis* (phase III, 46-58 years) and the endocranial obliteration of the cranial suture (coronal and sagittal suture are completely closed, the endocranial obliteration coefficient is 4.0, phase V, 58-72 years). Dental wear is very heavy (over 50 years).

13 teeth are preserved, 6 fell out post mortem, and 11 are missing, together with the maxilla. Both third molars in the mandible did not erupt or they were lost ante mortem. The teeth are healthy, without traces of dental caries. Dental wear is very strong ( $M_1 = 5+$ ,  $M_2 = 5$ ). The strong dental wear was compensated by the



Lobanja je ovoidne in hišaste oblike. Je dolga, srednje široka in nizka, aristenkefalna, na meji med dolihokranijo in mezokranijo, hamekрана, tapeinokрана, metriometopična in evrimandibularna.

Postkranialne kosti so zelo robustne, mišična narastišča dobro izražena. Telesna višina, izračunana po dolžinah femurja in radiusa, je 166,6 cm, po dolžini ulne pa 171,6 cm. Moški je bil verjetno visok okrog 167 cm, kar pomeni kategorijo srednje telesne višine.

Patologija: degenerativne spremembe na ledvenih vretenih (*spondylosis deformans*). Ohranjena so le zadnja tri vretenca L<sub>3-5</sub>, vsa imajo velike osteofite na robu korpusov (*osteophytosis*) in majhne osteofite na robu sklepnih odrastkov (*osteoarthritis*), na zgornji površini korpusa L<sub>5</sub> pa so prisotni tudi znaki osteohondroze. Nepopolna sakralizacija petega ledvenega vretenca L<sub>5</sub> na levi strani; na desni strani križnice in L<sub>5</sub> ni videti sprememb, vendar pa je ta stran poškodovana.

### Grob 3

– ženska, matusus, 40–60 let

Zelo slabo ohranjen skelet: nekaj fragmentov lobanje in diafize dolgih kosti.

Spolni znaki na medenici in lobanji so ženski (*tab. 7.2*), medtem ko sta kaput femurja in talus razmeroma robustna in po velikosti na mejni vrednosti za moški spol.

Lobanjski šivi so že zarasli (nad 40 let), struktura gobaste kostnine v proksimalni epifizi femurja ustreza fazi III (44–59 let). Abrazija zob je srednje močna.

Ohranjenih je le 5 zob: leva polovica mandibule s tremi zobmi in dva izolirana zoba iz maksile. Prvi premolar ima kariozno razjedo velikosti 2 mm na labialni strani zobnega vratu.

Postkranialne kosti so gracilne, mišična narastišča slabo izražena. Telesna višina je približno 160 cm.

### Grob 4

– domnevno moški, matusus I, 40–50 let

Okostje ima srednje dobro ohranjeno lobanjo z obraznim delom, medtem ko je postkranialni skelet v slabem stanju: ohranjene so diafize dolgih kosti okončin ter fragmenti ledvenih vretenc in medenice.

Pravilna določitev spola je vprašljiva zaradi mešanih spolnih znakov na medenici in večinoma slabo izraženih spolnih znakov na lobanji (*tab. 7.2*). Sklepna glava stegnenice je srednje krepka, mišična narastišča na stegnenici niso izražena, talus je gracilen in sodi v rang ženskih skočnic.

Tudi kazalniki starosti niso enotni. Po obliteraciji lobanjskih šivov, ki so že skoraj povsem zarasli (koeficient endokranialne obliteracije 3,7 – faza IV), bi bil moški star med 53 in 66 let. Glede na stanje in abrazijo zobovja pa je bil mlajši od 50 let. Menimo, da je v tem primeru abrazija zob boljši kazalnik starosti, čeprav je precej odvisna od načina prehrane. Za proces obliteracije

continuous growing of the teeth which is indicated by the exposed necks and roots. The distance between the cement-enamel junction (CEJ) and the edge of the tooth alveolus is 5 mm at the canines and 7 mm at the molars in the mandible. There are no signs of periodontal disease.

The cranium is of an ovoid and house shape. It is long, medium wide and low, aristenkefalic, on the border between *dolichocrania* and *mesocrania*, *chamaecrania*, *tapeinocrania*, *metriometopia* and *eurymandibular*.

The postcranial bones are very robust, the muscle attachment areas are pronounced. The body height, calculated from the length of the femur and radius, was estimated at 166.6 cm, while calculated from the length of the ulna it was estimated at 171.6 cm. The male was most likely approximately 167 cm tall, which meant that he was of average height.

Pathology: degenerative changes on the lumbar vertebrae (*spondylosis deformans*). Only the last three vertebrae L<sub>3-5</sub> are preserved, and all have large osteophytes on the edge of the bodies (*osteophytosis*) and small osteophytes on the articular facets (*osteoarthritis*), while the upper surface of the L<sub>5</sub> vertebral body also shows signs of osteochondrosis. Partial sacralisation of the fifth lumbar vertebrae L<sub>5</sub> on the left side; on the right side no changes can be seen on the sacrum and L<sub>5</sub>, however this side is damaged.

### Grave 3

– female, matusus, 40-60 years

Very poorly preserved skeleton: a few cranium fragments and the diaphysis of the long bones.

The sexual traits on the pelvis and cranium are female (*Table 7.2*), while the femur head and the talus are relatively robust and border on the dimensions ascribed to the male sex.

The cranial suture is obliterated (older than 40 years); the structure of the trabecular bone in the proximal epiphysis of the femur corresponds to phase III (44-59 years). Dental wear is moderate.

Only 5 teeth are preserved: the left half of the mandible with three teeth and two isolated teeth from the maxilla. The first premolar has a 2 mm caries erosion on the labial side of the neck.

The postcranial bones are gracile, the muscle attachment areas are poorly expressed. The body height measured at approximately 160 cm.

### Grave 4

– presumably male, matusus I, 40-50 years

The skeleton has an averagely preserved cranium and facial part, while the postcranial skeleton is in a poor condition: preserved are the diaphyses of the long bones and fragments of the lumbar vertebrae and the pelvis.

lobanjskih šivov je namreč značilna precejšnja individualna variabilnost (Key, Aiello, Molleson 1994). Glede na abrazijo zob je bil moški mlajši od tistega iz groba 1, ki smo mu določili starost 53–62 let.

Ohranjeni sta obe čeljustnici s 27 zobmi, trije zobje v maksili so izpadli pred smrtjo, skrajni desni del maksile z zadnjima dvema molarjema manjka. Zobje so v dobrem stanju, abrazija je srednje močna ( $M_1 = 3-4$ ,  $M_2 = 3$ ,  $M_3 = 2-3$ ), noben zob ni izpadel ante mortem. Na levem  $M_2$  je vidna začetna stopnja kariesa, razjeda velikosti 1–2 mm je na sredini okluzalne ploskve zobne krone. Ugriz je kleščast.

Lobanja je ovoidne in hišaste oblike. Je dolga, ozka do srednje široka in srednje visoka, evenkefalna, mezokrana, na meji med ortokranijo in hamekranijo, tapeinokrana, evrimetopična in mezomandibularna. Obraz je ozek in srednje visok – hiperleptoprozopen, zgornji del obraza je visok – hiperlepten. Ravno tako so visoke tudi orbite, ki so hipsikonhne, in nos, ki je leptorin.

Postkranialne kosti so na pogled srednje robustne, mišična narastišča slabo izražena. Izrazita lateralna asimetrija pri kosteh zgornjih okončin, leva klavikula in humerus sta veliko bolj gracilna kot desna, kar je razvidno iz vrednosti obodov (tab. 7.4). Dolžina tibije je izračunana na podlagi fragmenta (b–h 36 cm) in ustreza telesni višini 172 cm.

Patologija: začetna stopnja starostnih degenerativnih sprememb na treh ledvenih vretencih. Na sprednjem robu korpusa  $L_5$  so vidni zelo majhni osteofiti, na zgornji površini korpusa enega izmed ledvenih vretenc je viden odtis Šmorlovega vozla (posledica poškodovane medvretenčne ploščice), na fragmentu drugega pa znaki osteoartroze na spodnjem desnem sklepem odrastku. Zaceljena poševna fraktura leve tibije na distalnem delu korpusa na mestu minimalnega oboda.

#### Grob 5

– otrok, infans II, 10 let

Slabo ohranjen kompleten skelet v fragmentih.

Dentalna starost 10 let  $\pm$  30 mesecev. Ohranjeni sta obe čeljustnici s skoraj popolnim zobovjem (post mortem je izgubljen samo desni  $I_2$ ). Zobovje je v procesu menjave mlečnih zob s stalnimi (6 mlečnih zob, 13 stalnih zob, 12 zobnih zasnov stalnih zob).

Skeletna starost okrog 9 let (približna dolžina diafize humerusa 19 cm)

#### Grob 6

– otrok, infans I, 6–12 mesecev

Dobro ohranjen kompleten skelet.

Dentalna starost 9 mesecev  $\pm$  3 mesece. Ohranjeni so obe čeljustnici z izraslimi mlečnimi sekalci ter zobne zasnov preostalih mlečnih zob.

Due to the mixed sexual traits on the pelvis and especially due to the poorly expressed sexual traits on the cranium it is questionable whether the sex was accurately defined (Table 7.2). The femur head is of average strength, the muscle attachment areas on the femur are not pronounced, the talus is gracile and can be considered to have belonged to a female.

The age indices are also not uniform. According to the obliteration of the cranial sutures that are almost completely closed (endocranial obliteration coefficient 3.7 – phase IV), the male would have to be between 53 and 66 years old. However, the dental wear and general condition of his teeth indicate that he was not yet 50 years old. We are of the opinion that in this case dental wear is a better indicator of his age, even though it depends greatly on the diet. Relative individual variability is characteristic of the obliteration cranial suture process (Key, Aiello, Molleson 1994). Taking into account tooth wear the male was younger than the one found in grave 1, which we believe to be between 53 and 62 years old.

Both jawbones and 27 teeth were preserved, three teeth in the maxilla fell out ante mortem, and the far right part of the maxilla and the last two molars are missing. The teeth are in good condition, medium worn ( $M_1 = 3-4$ ,  $M_2 = 3$ ,  $M_3 = 2-3$ ). The left  $M_2$  shows the first stage of dental caries, a hole measuring approximately 1-2 mm in size is located in the centre of the occlusal surface of the tooth crown. The bite is plier like.

The cranium is of an ovoid and house shape. It is long, narrow to mid wide and mid high, *euencephalia*. Indices: *mesocrania*, on the border between *orthocrania* and *chamaecrania*, *tapeinocrania*, *eurymetopia*, *mesomandibular*. The face is narrow and medium high – *hyperleptoprosopia*, the upper part of the face is high – hyperlepten. The orbits are also high, and *hypsikonch*, while the nose is leptorrhine.

The postcranial bones appear to be averagely robust and the muscle attachment areas are not protruding. The bones of the upper extremities are laterally asymmetric, the left clavicle and humerus are much more gracile than the right (this is clearly visible from the circumference values, Table 7.4). The length of the tibia was calculated from the discovered fragment (b-h 36 cm) and would have belonged to an individual standing 172 cm tall.

Pathology: first stage of age related degenerative changes on three lumbar vertebrae. Very small osteophytes were noticed on the anterior edge of  $L_5$ . On the upper surface of one of the lumbar vertebrae a Schmorl's node was noticed (a result of a damaged intervertebral disc), while a fragment of the other vertebrae shows signs of osteoarthritis on the lower right articular facet. There is a healed diagonal fracture of the left tibia, at the point of the minimal circumference measurement.

Skeletna starost 6 mesecev (humerus 86 mm, radius 66 mm, femur 103 mm). Obe polovici mandibule sta že zrasli, krila zagozdnice (*ala magna os sphenoidale*) pa so še ločena od korpusa.

#### Grob 7

– otrok, infans I, 4 leta

Slabo ohranjen kompleten skelet v fragmentih.

Dentalna starost 4 leta ± 12 mesecev. Ohranjeni sta obe čeljustnici z 12 mlečnimi zobmi, 8 mlečnih zob manjka post mortem, stalni zobje še niso začeli izraščati, vidne so zobne zasnove I<sup>1</sup> in M<sub>1</sub>.

Skeletna starost 3 leta (približna dolžina diafize humerusa 13 cm). Loki vretenc so že zrasli, korpus pa je še ločen. *Pars lateralis* in *pars basilaris* zatilnice še nista zrasla.

#### Grob 8

– otrok, infans I, 2 leti

Delno ohranjen skelet: fragmentirana lobanja, nekaj reber in vretenc, klavikula, del radiusa, obe črevnici, femurja in tibiji.

Dentalna starost 2 leti ± 8 mesecev ali 3 leta ± 12 mesecev. Ohranjeni sta obe čeljustnici z 19 mlečnimi zobmi, desni m<sup>1</sup> manjka post mortem. Stalni zobje še niso izrasli, vidne so zasnove I<sup>1</sup> in M<sub>1</sub>.

Skeletna starost 18–24 mesecev (približna dolžina diafize femurja 135 mm).

#### Grob 9

– otrok, infans I, 2 leti

Kompleten skelet v fragmentih.

Dentalna starost 2 leti ± 8 mesecev. Ohranjeni sta obe čeljustnici s 13 mlečnimi zobmi, 7 jih manjka post mortem, stalni zobje še niso izrasli.

Skeletna starost 18 mesecev (humerus 108 mm, tibija 112 mm).

Posebnosti: kosti zgornje okončine (oba humerusa in ulni) so zelo robustne, še posebej v primerjavi s kostmi spodnje okončine (femur in tibia). Minimalni obod humerusa (38 mm) je enak minimalnemu obodu tibije (37 mm) in le malo manjši od srednjega oboda femurja (43 mm). Skelet iz groba 8, ki pripada otroku približno iste starosti, ima ob enakem obodu femurja (43 mm) manjši obod humerusa (33 mm), kar je normalno.

#### Grob 10

– otrok, infans I, 6–9 mesecev

Zelo slabo ohranjen skelet, samo nekaj fragmentov kompaktne kostnine in lobanjskega krova ter mandibula.

Dentalna starost 6 mesecev ± 3 mesece ali 9 mesecev ± 3 mesece. Ohranjena je samo mandibula z obema

#### Grave 5

– child, infans II, 10 years

Poorly preserved and fragmented skeleton.

Dental age: 10 years ± 30 months. Both jawbones are preserved as are almost all teeth (only the right I<sub>2</sub> was lost post mortem). The teeth were in the process of changing from deciduous to permanent dentition (6 deciduous teeth, 13 permanent teeth, 12 tooth crowns for permanent teeth).

Skeletal age: approximately 9 years (approximate length of the humerus diaphysis is 19 cm).

#### Grave 6

– infant, infans I, 6–12 months

Well preserved and complete skeleton.

Dental age: 9 months ± 3 months. Both jawbones are preserved together with the deciduous incisors and the tooth crowns of the not yet erupted deciduous teeth.

The skeleton age is 6 months (humerus 86 mm, radius 66 mm, femur 103 mm). Both halves of the mandible have already fused, while the wings of the sphenoid bone are still separated from the main bone body.

#### Grave 7

– child, infans I, 4 years

Poorly preserved fragmented, but complete, skeleton.

Dental age: 4 years ± 12 months. Both jawbones are preserved together with 12 deciduous teeth, 8 deciduous teeth fell out post mortem, permanent teeth did not start to erupt yet, the tooth crowns of I<sup>1</sup> and M<sub>1</sub> are visible.

Skeletal age: 3 years (the approximate length of the humerus diaphysis is 13 cm). The both halves of vertebral arch has already fused, while the body is still separated. The *pars lateralis* and *pars basilaris* of the occipital bone have not fused yet.

#### Grave 8

– child (early childhood), infans I, 2 years

Partially preserved skeleton. Preserved are: a fragmented cranium, a few ribs and vertebrae, clavicle, a part of the radius, both ilia, femurs and tibias.

Dental age: 2 years ± 8 months or 3 years ± 12 months. Both jawbones are preserved together with 19 deciduous teeth, the left m<sup>1</sup> is missing post mortem. The permanent teeth have not emerged yet, the crowns for I<sup>1</sup> and M<sub>1</sub> are visible.

Skeletal age: 18–24 months (approximate length of the femur diaphysis is 135 mm).

#### Grave 9

– child (early childhood), infans I, 2 years

$m_I$ ,  $m_{II}$  še nista izrasla, ostali zobje manjkajo post mortem. Obe polovici mandibule se še nista zrasli.

#### Grob 11

– otrok, infans I, 6 mesecev

Ohranjeni so samo fragmenti obeh femurjev in leva senčnica.

Skeletna starost 6 mesecev je določena po približno ocenjeni dolžini femurja (cca 9–10 cm).

#### Grob 12

– otrok, infans II, 10–12 let

Slabo ohranjen skelet: fragmenti lobanje, klavikula, desni humerus, fragment tibije.

Dentalna starost 10 let  $\pm$  30 mesecev. Ohranjeni so osrednji del korpusa mandibule s 6 stalnimi zobmi (vsi štirje I so že povsem izrasli, oba C sta v prodoru) ter 15 izoliranih zob (6 mlečnih in 9 stalnih).

Skeletna starost 10–12 let, ocenjena po približni dolžini humerusa (cca 21 cm).

#### Grob 13

– otrok, infans II – juvenis, 13–15 let

Slabo ohranjen skelet: vse kosti lobanje v fragmentih, od postkraniuma pa le del drugega vratnega vretenca (*dens axis*), dva fragmenta reber, korpus radiusa in ulne, nekaj kosti manusa, fragmenti kolčnice, femurja in tibije, ena patela in ena stopalnica.

Dentalna starost 12 let  $\pm$  30 mesecev. Ohranjenih je 18 izoliranih stalnih zob (4 spodnji I, 4 C, 3 PM, 4  $M_1$ , 3  $M_2$ ) in 2 zasnovi  $M_3$ . Kanini in drugi molarji imajo še odprte korenine.

Skeletna starost 13–16 let. Distalne epifize radiusa, ulne, femurja in tibije so še ločene, ravno tako tudi kaput femurja. Pri prstnih členkih je trohlea že prirasla, baza pa je še ločena. Glede na velikost korpusa desnega radiusa ocenjujemo dolžino cele diafize na 18–19 cm, kar ustreza starosti 13 let ali več.

#### Grob 15

– ženska, adultus, 25–40 let

Slabo ohranjen skelet: vse kosti lobanje v fragmentih (rekonstrukcija nevrokranija), vratna vretenca, fragmenti reber, obeh ključnic, lopatic in nadlahtnic, nekaj fragmentov kosti manusa in deli diafize femurja.

Medenica ni ohranjena, na lobanji prevladujejo ženski spolni znaki (*tab. 7.2*).

Lobanjski šivi so še odprti (koeficient endokranialne obliteracije 0, faza I, 23–39 let), sternalni del ključnice je že prirasel (faza III, nad 25 let), abrazija zob je srednja (25–35 let).

Complete skeleton in fragments.

Dental age: 2 years  $\pm$  8 months. Both jawbones are preserved together with 13 deciduous teeth, 7 are missing post mortem, the permanent teeth have not erupted yet.

Skeletal age: 18 months (humerus 108 mm, tibia 112 mm).

Special characteristics: the bones of the upper extremities (both humeri and ulnae) are very robust, especially when compared to the bones belonging to the lower extremities (femur and tibia). The minimal circumference of the humerus (38 mm) equals the minimal circumference of the tibia (37 mm) and measures only slightly less than the medium circumference of the femur (43 mm). The skeleton from grave 8, which belongs to a child of a similar age, has at the same femur circumference (43 mm) but a smaller humerus circumference (33 mm), which is normal.

#### Grave 10

– infant, infans I, 6-9 months

Very poorly preserved skeleton, only a few fragments of the compact bone and the cranial vault and the mandible are preserved.

Dental age: 6 months  $\pm$  3 months or 9 months  $\pm$  3 months. Only the mandible with both  $m_I$  is preserved,  $m_{II}$  have not erupted yet, the remaining teeth went missing post mortem. The two halves of the mandible have not fused yet.

#### Grave 11

– infant, infans I, 6 months

Only fragments of the two femurs and the left temporal bone are preserved.

The skeletal age of 6 months was defined using the rough estimate of the femur length (approx. 9-10 cm).

#### Grave 12

– child, infans II, 10-12 years

Poorly preserved skeleton: preserved are cranium fragments, the clavicle, the right humerus, and a tibia fragment.

Dental age: 10 years  $\pm$  30 months. Preserved are the central part of the mandible with 6 permanent teeth (all four I have erupted entirely, both C are in the process of eruption) and 15 isolated teeth (6 deciduous and 9 permanent ones).

Skeletal age: 10-12 years, calculated from the rough estimate of the length of the humerus (approx. 21 cm).

#### Grave 13

– child or adolescent, infans II – juvenis, 13-15 years

Ohranjeni sta obe čeljustnici z 31 zobmi, levi  $M_3$  ni izrasel ali pa manjka ante mortem. Zobje so v dobrem stanju, abrazija je srednje močna ( $M_1 = 4+$ ,  $M_2 = 3+$  do  $4+$ ,  $M_3 = 2$  do  $3+$ ). Kariozna sta oba premolarja v levi maksili. Gre za začetno stopnjo kariesa, razjedi sta veliki 1 oz. 2 mm. Karies je lociran na stiku obeh premolarjev ( $PM^1$  distalno,  $PM^2$  meziano) na zgornjem robu zobne krone, lingvalno. Na lingvalnih ploskvah spodnjih incizivov so rahle obloge zobnega kamna. Rahla prognatija.

Lobanja je ovoidne in bombaste oblike. Je srednje dolga in srednje široka–široka, brahikrana–hiperbrahikrana, evrimetopična in mezomandibularna. Glede na ušesno višino je hipsikrana, tapeinokrana in aristenkefalna.

Postkranialne kosti so na pogled gracilne, merljivi sta bili samo ključnici.

### Grob 18

– moški, adultus I, 25–30 let

Srednje dobro ohranjen skelet: fragmentirana lobanja (rekonstrukcija) in vse postkranialne kosti razen stopal (večji del v fragmentih).

Spolni znaki na medenici so moški, na lobanji pa mešani (tab. 7.2).

Lobanjski šivi so še odprti (koeficient endokranialne obliterationije 0, faza I, 25–39 let), *synchondrosis sphaeno-occipitalis* je že zakostenela, *tuber ischiadicum* je prirasel (nad 24 let), abrazija zob je zelo rahla (17–25 let).

Ohranjeni sta obe čeljustnici z 31 zobmi, desni  $M^3$  ni izrasel. Zobje so zdravi, brez kariesa. Abrazija je zelo rahla ( $M_1 = 2+$ ,  $M_2 = 2$  do  $2+$ ,  $M_3 = 1$  do  $2$ ). Ugriz je normalen.

Lobanja je ovoidna in hišasta, s tendenco h klinasti obliki. Je zelo dolga, srednje široka in visoka, aristenkefalna, dolihokrana, ortokrana, metriokrana, na meji med metriometopijo in stenometopijo in mezomandibularna. Obraz je srednje širok in srednje visok – mezoprozopen, zgornji del mezen, nos je leptorin.

Postkranialne kosti so srednje krepke, telesna višina 172,3 cm.

Patologija: *cribra orbitalia*, neaktivna oblika, stopnja II po Brothwellu, obojestransko.

### Grob 19

– otrok, infans II, 8 let

Zelo slabo ohranjen skelet: fragmenti kosti lobanjskega krova, desni ramus mandibule, fragmenti dolgih kosti okončin.

Dentalna starost: zobje niso ohranjeni.

Skeletna starost 8 let (7–10 let), glede na približno ocenjeno dolžino diafize femurja (cca 25 cm).

### Grob 20

– moški, adultus II, 30–40 let

Poorly preserved skeleton: all cranial bones are fragmented, from the postcranial bones only a part of the second cervical vertebrae (*dens axis*), two rib fragments, the radius and ulna corpus, a few hand bones, fragments of innominate bones, the femur and tibia, one patella and one foot bone remain.

Dental age: 12 years  $\pm$  30 months. Preserved are 18 isolated permanent teeth (4 lower I, 4 C, 3 PM, 4  $M_1$ , 3  $M_2$ ) and 2 crowns of nonerupted  $M_3$ . The canines and second molars still have open roots.

Skeletal age: 13–16 years. The distal epiphysis of the radius, ulna, femur and tibia are still separated, as is the femur head. The trochlea in the phalanges has already fused to the shafts, however the base is still separated. Taking into account the size of the right radius we have estimated that the diaphysis measured 18–19 cm in length, which means that the individual was 13 years old or more.

### Grave 15

– female, adultus, 25–40 years

Poorly preserved skeleton: all cranium bones are fragmented (neurocranium reconstruction), preserved are also cervical vertebrae, rib fragments, fragments of both collar bones, scapulae and the humerus, a few fragments of the hand bones and a part of the femur diaphysis.

The pelvis is not preserved, and female sexual traits prevail on the cranium (Table 7.2).

The cranial suture is still open (endocranial obliteration coefficient 0, phase I, 23–39 years), the sternal part of the collar bone has already attached itself (phase III, over 25 years), dental wear corresponds to the age of 25–35.

Both jawbones and 31 teeth are preserved, the left  $M_3$  did not erupt or went missing ante mortem. The teeth are in good condition, dental wear is medium ( $M_1 = 4+$ ,  $M_2 = 3+$  to  $4+$ ,  $M_3 = 2$  to  $3+$ ). The two premolars in the left maxilla have first stage caries, at which the cavities measure between 1 and 2 mm. The caries is located at the contact of the two premolars ( $PM^1$  distal,  $PM^2$  mesial) on the upper edge of the tooth crown, lingual. Slight calculus deposits traces were noticed on the lingual surfaces of the lower incisors. Slight prognathism was also present.

The cranium is of an ovoid and bomb shape. It is medium length and medium wide to wide. Indices: *brachy- crania* with tendency to *hyperbrachicrania*, *eurymetopia*, *mesomandibular*; according to ear height *porion-bregma hypsicrania*, *tapeinocrania*, *aristencephalia*.

The postcranial bones appear gracile, but only the collar bones could be measured.

### Grave 18

– male, adultus I, 25–30 years

Zelo slabo ohranjen, preperel skelet: fragmenti lobanje (rekonstrukcija ni mogoča) in korpusov dolgih kosti.

Medenica ni ohranjena, spolni znaki na lobanji so moški (tab. 7.2).

Abrazija zob ustreza starosti 25–35 let.

Ohranjenih je 25 zob, eden je izpadel post mortem, 6 pa jih manjka vključno z deli čeljustnic. Zobje so zdravi, brez kariesa. Abrazija je srednje močna ( $M_1 = 4$  do  $4+$ ,  $M_2 = 3$  do  $4$ ,  $M_3 = 3$  do  $4+$ ). Postkranialne kosti so na pogled robustne, mišična narastišča dobro izražena.

Patologija: zaceljena fraktura leve tibije, na sredini korpusa.

### Grob 21

– ženska, adultus II, 30–40 let

Slabo ohranjen skelet: fragmentirana lobanja (rekonstrukcija) in fragmenti skoraj vseh postkranialnih kosti (manjkajo desna kolčnica in večina vretenc: ohranjeni so delci 4 vratnih in/ali zgornjih prsnih vretenc ter loka 2 ledvenih).

Spolni znaki na medenici in lobanji so ženski (tab. 7.2).

Lobanjski šivi so še odprti (koeficient endokranične obliteracije 0.2, faza I, 25–39 let).

Ohranjeni so delčki maksile (brez zob in vidnih alveol) ter mandibula s 3 zobmi (6 jih manjka ante mortem, ostali post mortem). Abrazija levega  $PM_1$  je rahla, pri ostalih dveh zobeh (levi  $PM_2$ , desni  $I_2$ ) pa srednja do močna ter poševna, močnejša na distalni strani zobne krone.

Lobanja je pentagonoidna in klinasta s tendenco k hišasti obliki. Je zelo dolga in srednje široka, aristenkefalna, mezokrana, ortokrana in metriokrana (z močno tendenco k dolihokraniji in hipsikraniji), stenometopična in na meji med mezomandibularnim in leptomandibularnim tipom.

Postkranialne kosti so gracilne, telesna višina nedoločljiva.

Patologija: osteohondroza vratnih oz. zgornjih prsnih vretenc.

## 7.2.2 STRUKTURA OKOSTIJ PO SPOLU IN STAROSTI

Razporeditev skeletov po spolu in starostnih kategorijah prikazuje tab. 7.1. Prevladujejo otroška okostja, ki jih je 10. V zgodnji otroški dobi *infans I* je umrlo 6 otrok: trije so bili stari od 6 do 12 mesecev, dva približno 2 leti, eden pa 4 leta. V pozni otroški dobi *infans II* so umrli 4 otroci: najmlajši je štel 8 let, naslednja dva med 10 in 12 let, medtem ko je četrti umrl na prehodu v mladostniško obdobje, med 13. in 16. letom starosti. Otroška okostja predstavljajo 55,5 % skeletne serije, če upoštevamo razdelitev po kronoloških obdobjih pa celo 71,4 %. Vsi otroški skeleti namreč sodijo v poznoantično

Averagely preserved skeleton: fragmented cranium (reconstruction) and all postcranial bones except the feet (mostly fragmented).

The sexual traits on the pelvis are male, while on the cranium they are mixed (Table 7.2).

The cranial suture is still open (endocranial obliteration coefficient 0, phase I, 25–39 years), *synchondrosis sphaenooccipitalis* has already ossified, the *tuber ischiadicum* has attached itself (over 24 years), dental wear is very slight (17–25 years).

Both jawbones with 31 teeth are preserved, the left  $M^3$  did not erupt. The teeth are healthy and no traces of caries were found. Dental wear is slight ( $M_1 = 2+$ ,  $M_2 = 2$  to  $2+$ ,  $M_3 = 1$  to  $2$ ). The bite is normal.

The cranium is ovoid and house shaped, with the tendency to be wedge shaped. It is very long, medium wide and high, aristenkefalic, dolichocranial, ortocranial, metriocranial, on the border between metriometopic and stenometopic; it is also mesomandibular. The face is medium wide and medium high – *mesoprosopia*, the upper part is mesial, the nose is leptorrhine.

The postcranial bones are of medium strength, the body height measured in at 172.3 cm.

Pathology: *cribra orbitalia*, inactive form, grade II according to Brothwell, on both sides.

### Grave 19

– child, late childhood, infans II, 8 years

Very poorly preserved skeleton: fragmented bones of the cranial vault, the right ramus of mandible, fragments of the long bones.

Dental age: no teeth were preserved.

Skeletal age: 8 years (7–10 years), deduced from the roughly estimated length of the femur diaphysis (approx. 25 cm).

### Grave 20

– male, adultus II, 30–40 years

Very poorly preserved, decayed skeleton: fragments of the cranium (reconstruction is impossible) and the shafts of the long bones.

The pelvis is not preserved, the sexual traits on the cranium are male (Table 7.2).

The dental wear corresponds to the age between 25 and 35.

25 teeth are preserved, one was lost post mortem, 6 are missing together with parts of the jawbones. The teeth are healthy, there are no signs of dental caries. Dental wear is medium ( $M_1 = 4$  to  $4+$ ,  $M_2 = 3$  to  $4$ ,  $M_3 = 3$  to  $4+$ ). The postcranial bones appear robust; the muscle attachment areas are protruding.

Pathology: a healed fracture of the left tibia, in the middle of the shaft.

obdobje. Iz tega časa so tudi 4 odrasli skeleti, preostali 4 odrasli skeleti pa so iz zgodnj srednjeveškega obdobja.

Med odraslimi okostji je 5 moških in 3 ženska, vendar je pri moškem iz groba 4 pravilna določitev spola vprašljiva (tab. 7.2). V poznoantično obdobje sodijo 3 moški in 1 ženska: mladenič je umrl v starosti

### Grave 21

– female, adultus II, 30-40 years

Poorly preserved skeleton: fragmented cranium (reconstruction) and fragments of almost all postcranial bones (the right innominate bone and most of the vertebrae are missing; parts of the 4 cervical and/or upper

Tab. 7.1: Tonovcov grad pri Kobaridu. Struktura skeletov po spolu in starosti.

Tab. 7.1: Tonovcov grad at Kobarid. Structure of skeletons by sex and age.

spol / sex	moški / male		ženski / female		nedoločljiv / undetermined		skupaj / total	
	N		N		N		N	%
	PA / LA*	ZSV / EMP**	PA / LA*	ZSV / EMP**	PA / LA*	ZSV / EMP**		
infans I					6		6	33,3
infans II					4		4	22,2
juvenis	1						1	5,6
adultus		2		2			4	22,2
maturus	2		1				3	16,7
senilis								
skupaj / total	3	2	1	2	10		18	100,0

\* PA – poznoantično obdobje / LA – Late Antiquity

\*\* ZSV – zgodnj srednjeveško obdobje / EMP – Early Medieval period

Tab. 7.2: Tonovcov grad pri Kobaridu. Spolni znaki pri odraslih skeletih – individualni podatki.

Tab. 7.2: Tonovcov grad at Kobarid. Sexual traits in adult skeletons – individual data.

skelet št. / skeleton No	1a	1	3	4	15	18	20
glabella		+2		0	-1	0	
processus mastoideus	+2	+2	-1	+2	-1	+2	+2
relief planum nuchale		+1				0	
processus zygomaticus						0	
arcus superciliaris		+2		+1	-2	+1	
tuber frontale et parietale		+2		+1	-1	-1	
protuberantia occipitalis ext.	-2	+2	-2	+1	-2	+1	0
os zygomaticum	+2		-2	+1	0	+2	
inclinatio frontale		+2		+1	-1	0	
forma orbitae		+1		-2			
margo orbitae	+1			+1	-2	-1	
corpus mandibulae		+1	-2	+1	-1	+1	
trigonum mentale	-1	+1	-2	+2	+1	-1	+1
angulus mandibulae		+1	-1	+1	-1	+1	
sulcus preauricularis	+2	+2	-2	+2		+2	
incisura ischiadica major	+1	+2	-2	-2		-1	
arcus compositus	+2	+2	-2	+2		+2	
angulus pubis		+2					
os coxae		+2					
linea aspera	+1	+2	0	-1		+1	+2
caput femoris		+2	+1	+1	-1	+1	
talus max. /mm/		57	52	47			
stopnja seksualizacije / sex. degree	+1,24	+1,66	-1,50	+0,85	-0,96	+0,69	+1,25
spol / sex	m / m	m / m	ž / f	m / m ?	ž / f	m / m	m / m

okrog 20 let (grob 1a), preostale tri osebe pa po 40. letu (grobovi 1, 3, 4). Oba moška in obe ženski iz zgodnje-srednjeveške dobe so umrli pred dopolnjenim 40. letom starosti (grobovi 15, 18, 20, 21).

### 7.2.3 MORFOLOŠKE ZNAČILNOSTI

Okostja so bila zelo slabo ohranjena. Lobanje so bile fragmentirane, po rekonstrukciji smo lahko delno izmerili tri moške in dve ženski lobanji, obrazni del pa je bil v celoti ohranjen le pri eni (tab. 7.3; sl. 7.3). Tudi postkranialne kosti so bile ohranjene fragmentarno, deli zgrajeni iz gobaste kostnine, so sprhneli. Večinoma smo lahko izmerili le premere in obode močnejših kosti, dolžino kosti, potrebno za izračun telesne višine, je bilo mogoče izmeriti le pri treh skeletih, pri dveh okostjih pa smo dolžino lahko ocenili na podlagi ohranjenega fragmenta kosti (tab. 7.4).

thoracic vertebrae and the arches of 2 lumbar ones are preserved).

The sexual traits on the pelvis and cranium are female (Table 7.2).

The cranial suture is still open (endocranial obliteration coefficient 0.2, phase I, 25-39 years).

Parts of the maxilla are preserved (without the teeth and visible tooth sockets) as is the mandible with 3 teeth (6 are missing ante mortem, the rest post mortem). The left PM<sub>1</sub> is slightly worn, and at the remaining two teeth (left PM<sub>2</sub>, right I<sub>2</sub>) the wear is medium to strong and slanting, stronger on the distal side of the tooth crown.

The cranium is pentagonoid and wedge shaped with a slight tendency towards the house shape. It is very long to medium wide, aristencefalic, mesocranial, ortocranial and metriometopic (with a strong tendency towards *dolichocrania* and *hypsicrania*), stenometopic and on the border between the mesomandibular and leptomandibular type.

Tab. 7.3: Tonovcov grad pri Kobaridu. Mere (mm) in indeksi lobanj ter lobanjska prostornina (ccm) – individualni podatki.

Tab. 7.3: Tonovcov grad at Kobarid. Skull measurements (mm), indices and cranial capacity (ccm) – individual data.

skelet št. / skeleton No.	1	4	15	18	21
Spol / sex	m / m	m / m	ž / f	m / m	ž / f
Martin št. / Martin No.					
1	195	186	170	194	185
2	192	184	165	189	180
5	100	106		102	
7	39			37	
8	145-150	142	145	144	140
9	98	103	100	95	89
10	122	123	123	120	117
11	128			121	103
12	107		100	107	106
13	108		106	108	101
16	30			32	
17	125	130		140	
20	107	112	113	120	116
45		122-125		130	
47		120		115	
48		80		70	
50		24		-	
51 l		41		-	
52 l		37		-	
54		26		24	
55		61		54	
65			113	113	
66	110	103	97	96	85
69	min. 30	29		29	
70	65	60	55	64	
8:1	74,4-76,9	76,3	85,3	74,2	75,7
17:1	64,1	69,9		72,2	
17:8	68,2-83,3	91,5		97,2	
20:1	54,9	60,2	66,5	61,9	62,7
20:8	73,8-71,3	78,9	77,9	83,3	82,9



skelet št. / skeleton No.	1	4	15	18	21
Spol / sex	m / m	m / m	ž / f	m / m	ž / f
Martin št. / Martin No.					
9:10	80,3	83,7	81,3	79,2	76,1
9:8	67,6-65,3	72,5	69,0	66,0	63,6
16:7	76,9			86,5	
47:45		98,4-96,0		88,5	
48:45		65,6-64,0		53,8	
66:45		84,4-82,4		73,8	
52:51 l		90,2		-	
54:55		42,6		44,4	
66:65			85,8	85,0	
9:45		82,4-84,4		73,1	
66:9	112,2	100,0	97,0	101,1	95,5
lob.prost. <sub>17</sub> / cran. cap. <sub>17</sub>	1465-1497	1438		1565	
lob.prost. <sub>20</sub> / cran. cap. <sub>20</sub>	1464-1502	1439	1341	1583	1423

Tab. 7.4: Tonovcov grad pri Kobaridu. Mere (mm) in indeksi postkraniuma ter telesna višina (po Manouvrierju) – individualni podatki.

Tab. 7.4: Tonovcov grad at Kobarid. Postcranial measurements (mm), indices and stature (Manouvrier method) – individual data.

skelet št. / skeleton No.	1a	1	3	4	15	18	20	21
spol / sex	m / m	m / m	ž / f	m / m	ž / f	m / m	m / m	ž / f
Martin št. / Martin No.								
desna – leva / right - left	d l	d l	d l	d l	d l	d l	d l	d l
Cl 1					135 140			
Cl 6	35	41	29	42 36	38 39	40 43		33
Cl 6:1								
H 1						350		
H 2								
H 4						62		
H 7	60 58		53	63 55		65	68 66	52
H 9								35
H 10			42					39
H 7:1								
R 1	241	244						
R 2		229						
R 3	40 41	48 50					46	33
R 5,1								
R 3:2		21,0						
U 1		273						
U 2		230						
U 3		47 45						
U 3:2		20,4						
F 1		453	441			478		
F 2		447	439			473		
F 8	85 87	96 99	84 83	89 91		93	100	78
F 9	28 30	32	31 31	31 33		30 30	31	
F 10	23 23	29	22 22	24 25		27 26	27	
F 18		53 52	45 45	46	42	46 46		41
F 21								
F 10:9	82,1 76,7	90,6	71,0 71,0	77,4 75,8		90,0 86,7		
F 8:2		21,5	19,1			19,7		
T 1								

skelet št. / skeleton No.	1a	1	3	4	15	18	20	21
spol / sex	m / m	m / m	ž / f	m / m	ž / f	m / m	m / m	ž / f
Martin št. / Martin No.								
T 1a	371			391				
T 3								
T 8a	33		31	35 33		36	32	32
T 9a	20		20	24 23		26	26	26
T 10b	70		70	78		77 78		
T 9a:8a								
T 10b:1	–							
telesna višina / stature	1666	1666	1600	1720		1723		

### MOŠKI

Vse tri merljive moške lobanje, dve poznoantični in ena zgodnesrednjeveška, so dolge in srednje široke, kranialni indeks (od 74,2 do 76,3) je na meji med dolihokranijo in mezokranijo. Po obliki so ovoidne in hišaste ter imajo veliko lobanjsko prostornino. Razlikujejo pa se po višini lobanje, fronto-parietalnem indeksu in karakteristikah obraza. Poznoantična lobanja št. 1 je nizka in metriometrična, ima evrimandibularen obraz s široko mandibulo ter močno izraženo glabelo in nadočasne oboke. Drugi dve lobanji sta višji, obe imata mezomandibularen obraz s srednje široko mandibulo, ozek leptorin nos ter manj poudarjene moške spolne znake v predelu čela. Poznoantična lobanja št. 4 je srednje visoka, ima široko čelo (evrimetopija) ter ozek in srednje visok obraz, ki je hiperleptoprozopen in hiperlepten. Zgodnesrednjeveška lobanja št. 18 je visoka, ima ozko čelo (metriometripija s tendenco k stenometripiji) ter nekoliko širši in krajši obraz, ki je mezoprozopen in mezen.

Moški skelet št. 1 se od ostalih dveh razlikuje tudi po postkranialnih karakteristikah. Ima zelo robustne kosti, po telesni višini 167 cm pa sodi v kategorijo srednje visokih moških. Za okostji št. 4 in 18 so značilne manj krepke kosti in višja telesna višina. Oba sta bila visoka okrog 172 cm, kar pomeni kategorijo visoke telesne višine. Po stari klasifikaciji bi skelet 1 uvrstili v kromanjonidni tip, preostala dva pa v nordidni.

Kosti postkraniuma so bile deloma merljive še pri dveh moških okostjih. Zgodnesrednjeveški skelet št. 20 ima podobno kot št. 1 zelo krepke kosti, medtem ko poznoantični skelet št. 1a (srednja telesna višina, okrog 167 cm) bolj spominja na okostji št. 4 in 18. Ima najbolj gracilne kosti izmed vseh, na slabo razvito mišičevje pa poleg neizraženih mišičnih narastišč opozarja tudi nastanek *perforatio fosse olecrani* na humerusu.

### ŽENSKE

Merljivi sta bili dve lobanji, ki si nista podobni, čeprav sta obe zgodnesrednjeveški. Lobanja št. 21 je po

Postcranial bones are gracile, the body height undefinable.

Pathology: osteochondrosis of the cervical or upper thoracic vertebrae.

### 7.2.2 STRUCTURE OF THE SKELETONS BY SEX AND AGE

The division of skeletons by sex and age is shown in *Table 7.1*. Child skeletons prevail, as there are 10 of them. 6 children died in the early infant stage *infans I*: 3 were infants between 6 and 12 months old, two were approximately 2 years old, and one was 4 years old. 4 children died in the late childhood *infans II*: the youngest was 8 years old, the next two between 10 and 12, while the fourth died on the transition into the juvenile stage, between the ages of 13 and 16. Child skeletons represent 55.5 % of the skeletal series, and if we take into account the division by chronological periods this percentage raises to as much as 71.4 %. All child skeletons originate from Late Antiquity. 4 adult skeletons were also dated to this period, while the remaining 4 adult skeletons belong to the Early Medieval period.

Amongst the adult skeletons 5 are male and 3 female, however it is questionable whether the skeleton from grave 4 is truly male (*Table 7.2*). 3 male and 1 female skeletons were dated into Late Antiquity: the youth died approximately at the age of 20 (grave 1a), while the remaining three individuals died after their 40<sup>th</sup> birthday (graves 1, 3, 4). Both males and both females from the Early Medieval period died before they reached 40 (graves 15, 18, 20, 21).

### 7.2.3 MORPHOLOGICAL CHARACTERISTICS

The skeletons are very poorly preserved. The skulls are fragmented. Following the reconstruction we could partially measure three male and two female craniums, while the facial part was preserved in its entirety in a single

obliki pentagonoidna in klinasta, št. 15 pa ovoidna in bombasta. Prva je, enako kot tukajšnje moške lobanje, zelo dolga in srednje široka, mezokrana s tendenco k dolihokraniji. Druga je krajša in širša, kar se odraža tudi v kranialnem indeksu (85,3), ki kaže na brahikranijo s tendenco k hiperbrahikraniji. V absolutni ušesni višini med njima ni razlike, relativno gledano pa je prva lobanja ortokrana in metriokrana, druga pa hipsikrana in tapeinokrana. Prva lobanja ima tudi ožje čelo in mandibulo kot druga: je stenometopična in na meji med mezomandibularnim in leptomandibularnim tipom, lobanja št. 15 pa evrimetopična in mezomandibularna.

Telesne višine tema dvema skeletoma ni bilo moč določiti. Je pa ženska iz groba 21 imela gracilne kosti, podobno kot ženska iz poznoantičnega groba 3, ki je bila visoka 160 cm.

#### PRIMERJAVA S SLOVENSKIMI POZNOANTIČNIMI SERIJAMI

Primerjali smo kranialni indeks in telesno višino moških iz štirih poznoantičnih najdišč: Tonovcov grad, Ajdna (Leben-Seljak 1995, 1996a), Pristava I na Bledu (Leben-Seljak 1996a) in Vrajk (Leben-Seljak 2003).

Za vse štiri serije so značilne dolihokrane in mezokrane lobanje. Oba moška z Ajdne imata sicer krajši lobanji (177 in 179 mm), vendar sta tudi ožji (135 in 142 mm) in zato ravno tako mezokrani. Lobanja št. 7 z Ajdne ima izrazite kromanjonidne karakteristike in je v tem podobna tukajšnjemu skeletu 1. Za Pristavo I in Vrajk so, enako kot za Tonovcov grad, značilne dolge in zelo dolge lobanje, ki pa so zaradi manjše širine nekoliko bolj dolihokrane. To velja za večino okostij, se pa na obeh najdiščih pojavljajo tudi posamezniki s krajšimi in širšimi – brahikranimi lobanjami (sl. 7.1).

Medtem ko v kranialnem indeksu nismo ugotovili razlik, pa to ne velja za telesno višino. Predvsem dva moška (skelet 4 in 18) s Tonovcovega gradu sta s

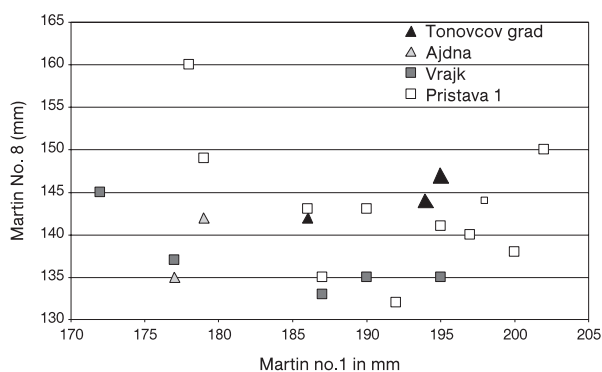

Sl. 7.1: Dolžina in širina moških lobanj v poznoantičnih slovenskih skeletnih serijah.

Fig. 7.1: Maximum cranial length and width of male skulls from Slovenian Late Antiquity sites.

example (Table 7.3; Fig. 7.3). The postcranial bones were preserved fragmentarily and the trabecular bone turned to dust. In most cases we could only measure the diameters and circumferences of the stronger bones, the length of the bone necessary to calculate the body height could be measured in three examples, while for two examples we estimated the bone length on the basis of the preserved bone fragment (Table 7.4).

#### MALE

All three male skulls that could be measured, two Late Antiquity and one Early Medieval one, are long and medium wide; the cranial index (between 74.2 and 76.3) is on the border between *dolichocrania* and *mesocrania*. By shape they are ovoid and house like and the cranium is large in volume. They differ by the height of the cranium, the frontal-parietal index and facial characteristics. The Late Antiquity cranium No. 1 is low and metriometopic, it has an euromandibular face with a wide mandible and a strongly emphasised glabella and orbits. The remaining two craniums are higher, both have a mesomandibular face with a medium wide mandible, a narrow leptorrhine nose and less pronounced male sex traits in the forehead area. The Late Antiquity cranium No. 4 is of medium height, has a wide forehead (*eurymetopia*) and a narrow and medium high face, which falls in the category of *hyperleptoprosopia* and *hyperleptia*. The Early Medieval cranium No. 18 is high, has a narrow forehead (*metriometopia* with a tendency to *eurymetopia*) and a slightly wider and shorter face that is mesoprosopic.

Male skeleton No. 1 differs from the other two also by its postcranial characteristics. It has very robust bones, and with a body height of 167 cm the individual was an averagely tall male. The bones of skeletons Nos. 4 and 18 are not as strong however the individuals were taller. Both were approximately 172 cm high, which was tall at the time. According to the old classification we would define skeleton No. 1 as Cro-magnon, and the remaining two as Nordid.

The postcranial bones could be measured (to a certain degree) at two other male skeletons. The Early Medieval skeleton No. 20 has very robust bones (similar to skeleton No. 1), while the Late Antiquity skeleton No. 1a (medium body height, approximately 167 cm) is closer to skeletons Nos. 4 and 18. Skeleton No. 1 has the most gracile bones of them all, and the poorly developed muscles are indicated by the non-protruding muscle attachment areas and the *perforatio fosse olecrani* on the humerus.

#### FEMALE

It was possible to measure two craniums, and they are dissimilar even though they are both Early

172 cm precej velika, telesna višina drugih dveh pa je za tisti čas bolj običajna, čeprav sta še vedno med višjimi. Oba moška z Ajdna sta precej manjša, velika 157,6 cm in 164,4 cm. Za Vrajk imamo podatke o telesni višini sedmih moških. Večinoma so manjše postave: pet je velikih med 163 in 165 cm, eden 169 cm in eden 171 cm. Podobno velja tudi za Pristavo I: med desetimi moškimi je šest manjših od 165 cm, dva sta velika 166 in 167 cm, eden 169,7 cm in eden 175 cm. Se pravi, da so med vsemi 23 moškimi le štirje višji od 170 cm in od teh sta dva s Tonovcovega gradu, eden iz pozne antike in drugi iz zgodnjega srednjega veka. Razlika je še opaznejša pri primerjavi povprečne telesne višine moških, ki je pri Tonovcovem gradu 169,4 cm (oz. 168,4 cm za pozno-antično serijo), medtem ko je povprečje za preostala tri najdišča 164,5 cm (Ajdna 161 cm, Pristava I 164,3 cm, Vrajk 165,9 cm).

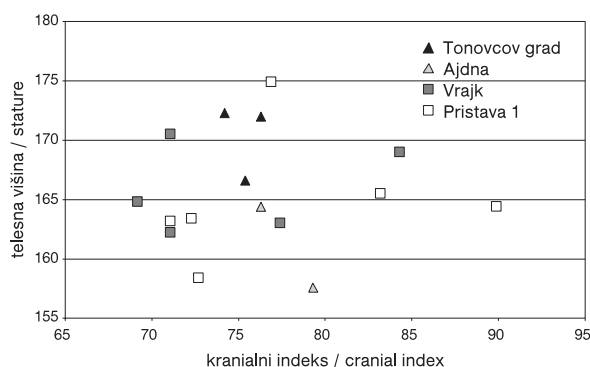

Sl. 7.2: Kranialni indeks in telesna višina moških v poznoantičnih slovenskih skeletnih serijah.

Fig. 7.2: Cranial index and stature of males from Slovenian Antiquity sites.

Na sliki 7.2 so v koordinatnem sistemu prikazani skeleti, za katere imamo podatke tako o kranialnem indeksu kot o telesni višini. Tudi tu je razvidno, da ima večina okostij dolihokrane (vrednost kranialnega indeksa pod 75) ali mezokrane lobanje (vrednost indeksa 75–80) in le trije brahikrane. Oba skeleta s Tonovcovega gradu izstopata po telesni višini, saj sta jima enaka le skelet št. 19 z Vrajka in skelet št. 279 s Pristave I.

#### 7.2.4 EPIGENETSKI ZNAKI

Analiza ni dala uporabnih rezultatov, deloma zaradi slabe ohranjenosti lobanj, deloma pa zaradi nespecifičnih epigenetskih znakov (tab. 7.5). Lobanjski šivi so brez posebnosti, *ossiculum astericum* nastopa le pri eni lobanji, *sutura petrosquamosa* pa pri vseh treh merljivih moških lobanjah.

Medieval. Cranium No. 21 is pentagonoid and wedge shaped, while No. 15 is ovoid and bomb shaped. Similar to the male skulls found at this location the first is long and of medium width, mesocranial with a tendency towards dolichocranial. The second is shorter and wider, which is also reflected in the cranial index (85.3), which indicates a brachicranial type with a tendency to *hyperbrachicrania*. There is no difference between the two in the absolute ear height; relatively speaking the first cranium is ortocranial and metriometopic, while the second is hypsicranial and tapeinocranial. The first cranium also has a narrower forehead and mandible than the other: it is stenometopic and on the border between the mesomandibular and leptomandibular type, while cranium No. 15 is eurymetropic and mesomandibular.

It was impossible to estimate the body height of these two skeletons. Of the others the female from grave 21 had gracile bones, similar to the female from the Late Antiquity grave 3 who measured 160 cm tall.

#### COMPARISON WITH SLOVENIAN LATE ANTIQUITY SERIES

We compared the cranial index and body heights of males from four Late Antiquity sites: Tonovcov grad, Ajdna (Leben-Seljak 1995, 1996a), Pristava I at Bled (Leben-Seljak 1996a) and Vrajk (Leben-Seljak 2003).

Dolichocranial and mesocranial skulls are characteristic for all four series. Both men from Ajdna have a shorter cranium (177 and 179 mm), however they are also narrower (135 and 142 mm) and thus mesocranial. Cranium No. 7 from Ajdna has explicit Cro-Magnon characteristics which is a feature shared with skeleton 1 from our site. The skulls from Pristava I and Vrajk are also long or very long (similar to the ones from Tonovcov grad), however as they are slightly narrower they are somewhat more dochicranial. This holds true for most skeletons, however at both sites individuals were found with shorter and wider – brachicranial skulls (Fig. 7.1).

While we have not ascertained any differences in the cranial index, this was not the case as regards body heights. The two males (skeletons 4 and 18) from Tonovcov grad were relatively tall (172 cm), while the body heights of the other two were closer to the average for the time, even though they were still amongst the taller ones. Both males from Ajdna were quite a bit smaller, measuring 157.6 cm and 164.4 cm. For Vrajk we have the data on the body height of seven males. Most of them were of a smaller stature: five measured in between 163 and 165 cm, one was 169 cm and one 171 cm tall. Similar was discovered at Pristava I: amongst the ten males six of them were under 165 cm tall, two measured in at 166 and 167 cm, one at 169.7 cm and one at 175 cm.

Tab. 7.5: Tonovcov grad pri Kobaridu. Epigenetski znaki – individualni podatki.

Tab. 7.5: Tonovcov grad at Kobarid. Epigenetic traits – individual data.

skelet št. / skeleton No.	1		4		15		18		21	
	m / m		m / m		ž / f		m / m		ž / f	
spol / sex	d	l	d	l	d	l	d	l	d	l
sutura metopica	-		-		-		-		-	
sutura frontotemporalis	-	-	-				-	-		
sutura petrosquamosa	+	+	+		-	-	+	-	-	-
sutura praemaxillaris			-		-		-			
ossiculum bregmaticum	-		-		-		-		-	
ossiculum lambdoideum	-		-		-		-		-	
ossiculum astericum	-	-	-		-	+	-	-	-	-
ossiculum epiptericum			-							
ossiculum incisurae parietalis	-	-	-						-	-
ossa suturalia suturae sagittalis	-		-		-		-		-	
ossa suturalia suturae coronalis	-	-	-	-	-	-	-	-	-	-
ossa suturalia suturae lambdoideae	-	-	-	-	-	-	-	-	-	-
torus palatinus					-	-	-	-		
torus maxillaris					-	-	-	-		
processus marginalis			-		+	+				-
tuberculum pharyngeum	-		+				+	?		
tuberculum praecondylaris	-	-	-	-			-	-		
canalis condylaris posterior	+	+								
canalis hypoglossi dvojen / double	+	+	-	-						
foramen emissarium parietale			-	-	+	+	+	-	-	-
foramen mastoideus exsuturalis		+	-		-	+			+	-
foramen mastoideus manjka / absent		-	-		-				-	-
foramen supraorbitale	-	-	+	-	+	+	-	-	-	+
sulcus supraorbitalis	+	+	-	+		-	+	+	+	+
foramen infraorbitale dvojen / double				-						
foramen zygomaticofaciale dvojen / double			-	-	-	+	-	+		
foramen zygomaticofaciale manjka / absent			-	-	-	-	-	-		
foramen mentale dvojen / double	-	-	-	-	-	-	-	-		-
linea nuchae suprema	-		-		-					-
facies condylaris dvojen / double	-	-	-	-	-	-				

### 7.2.5 KARAKTERISTIKE ZOBOVJA

Pri nobenem skeletu ni opaziti anomalij v morfolo-  
giji in izražanju zob. Tudi anomalij v formiranju zobne  
sklenine (linearna hipoplazija) ni videti. Otroški skeleti  
nimajo karioznih zob, pri odraslih pa je stopnja kariesa  
nizka (tab. 7.6–7.8).

Kariozne zobe imajo trije odrasli skeleti od osmih:  
moški in ženska iz poznoantičnega obdobja (grobova 3  
in 4, oba *maturus*) ter ženska iz srednjeveškega obdobja  
(grob 15, *adultus*). Frekvenca kariesa je nizka, saj so  
od 161 ohranjenih zob kariozni le 4 zobje ali 2,48 %:  
pri skeletu 15 dva premolarja v maksili, pri preostalih  
dveh skeletih pa po en molar in premolar v mandibuli.  
V vseh primerih gre za začetno stopnjo kariesa, razjede  
so velike 1–2 mm. Lokacija kariesa je različna: v enem  
primeru na vratu, v treh pa na zobni kroni.

This means that from the total of 23 males only four  
were taller than 170 cm, two of which were discovered  
at Tonovcov grad, one dated to Late Antiquity and the  
other to the Early Medieval period. The difference is  
even more noticeable when we compare the average male  
body height at Tonovcov grad (169.4 cm or. 168.4 cm  
in Late Antiquity) with the average for the remaining  
three sites (164.5 cm - Ajdna 161 cm, Pristava I 164.3 cm,  
Vrajk 165.9 cm).

Figure 7.2 shows skeletons for which we have data  
on the cranial index as well as the body height. It can be  
noticed that most skeletons have dolichocranial (cranial  
index value below 75) or mesocranial skulls (index  
value 75-80) and only three have brachicranial ones.  
Both skeletons from Tonovcov grad step out as regards  
their body height, for only skeleton No. 19 from Vrajk  
and skeleton No. 279 from Pristava I can match them.

Tab. 7.6: Tonovcov grad pri Kobaridu. Frekvenca kariesa (C) in ante mortem izpadlih zob (AMTL) po starosti.  
Tab. 7.6: Tonovcov grad at Kobarid. Frequency of dental caries (C) and ante mortem tooth loss (AMTL) by age.

	okostja / individual count						zobje / tooth count					
	C			AMTL			C			AMTL		
	N	n	%	N	n	%	N	n	%	N	n	%
juvenis	1	0	0,00	1	0	0,00	26	0	0,00	30	0	0,00
adultus	4	1	25,00	4	1	25,00	90	2	2,22	98	4	4,08
maturus	3	2	66,67	3	2	66,67	45	2	4,44	59	6	10,17
skupaj / total	8	3	37,50	8	3	37,50	161	4	2,48	187	10	5,35

N – število skeletov / number of skeletons, C % - frekvenca karioznih zob / frequency of caries– tooth count, AMTL % - frekvenca ante mortem izpadlih zob / frequency of ante mortem tooth loss – tooth count

Tab. 7.7: Tonovcov grad pri Kobaridu. Frekvenca karioznih (C) in ante mortem izpadlih zob (AMTL) po tipu zoba.  
Tab. 7.7: Tonovcov grad at Kobarid. Frequency of dental caries (C) and ante mortem tooth loss (AMTL) by tooth type.

	Kariozni zobje / carious teeth					AM izpadli zobje / AMTL				
	maxilla		mandibula		skupaj / total	maxilla		mandibula		skupaj / total
	n	n <sub>c</sub>	n	n <sub>c</sub>		%	n	n <sub>AM</sub>	n	
I	17	0	19	0	0,00	19	0	30	0	0,00
C	10	0	11	0	0,00	10	0	14	0	0,00
PM	20	2	26	1	6,52	21	1	29	2	6,00
M	26	0	32	1	1,72	29	2	37	5	10,61
skupaj / total	73	2	88	2	2,48	79	3	110	7	5,35

N – število skeletov / number of skeletons, C % - frekvenca karioznih zob / frequency of caries– tooth count, AMTL % - frekvenca ante mortem izpadlih zob / frequency of ante mortem tooth loss – tooth count

Tab. 7.8: Stopnja kariesa pri odraslih skeletih iz poznoantičnih najdišč v Sloveniji.  
Tab. 7.8: Dental caries in adult skeletons from Late Roman period sites in Slovenia.

najdišče / site	st. / cent.	adultus (20-40 let / y.)			vsi odrasli / all adults			
		N	C %	AMTL %	N	C %	AMTL %	
Ptuj-Caissa <sup>a</sup>	3.–4.	28	2,52	1,42	45	2,49	4,97	
Brezje pri Zrečah <sup>a</sup>	3.–4.	6	17,39	10,63	23	14,84	33,39	
Kranj - Lajh 1902 <sup>b</sup>	6.	27	–	–	34	17,01	–	<sup>a</sup> Leben-Seljak,
Kranj - Lajh 2004 <sup>c</sup>	6.	5	14,84	5,48	8	11,00	6,41	Štefančič 2001,
Tonovcov grad	6.	–	–	–	4	2,48	5,35	<sup>b</sup> Krušič 1971,
Ajdna <sup>d</sup>	6.	4	0,00	0,00	5	2,52	6,47	<sup>c</sup> Leben-Seljak,
Bled - Pristava I <sup>d</sup>	6.–7.	15	7,80	1,48	30	8,29	4,13	neobj. /unpub., <sup>d</sup>
Vrajke <sup>e</sup>	6.–7.	6	12,50	6,00	13	14,58	12,73	Leben-Seljak 1996a,
Rifnik <sup>f</sup>	5.–7.	19	5,36	0,26	30	6,53	10,07	<sup>e</sup> Leben-Seljak 2003,
Puščava <sup>g</sup>	5.–9.	11	5,58	4,02	24	6,04	9,23	<sup>f</sup> Leben-Seljak 2006,
								<sup>g</sup> Leben-Seljak 2004

N – število skeletov / number of skeletons, C % - frekvenca karioznih zob / frequency of caries– tooth count, AMTL % - frekvenca ante mortem izpadlih zob / frequency of ante mortem tooth loss – tooth count

Za časa življenja so zobje izpadli trem osebam od osmih, že zgoraj omenjenima poznoantičnima skeletoma (grobova 3 in 4, oba *maturus*) ter zgodnje-srednjeveški ženski (grob 21, *adultus*). Skupno število ante mortem izpadlih zob je 10 ali 5,35 %, med njimi je 5 prvih molarjev. Frekvenca izpadlih zob je nizka,

#### 7.2.4 EPIGENETIC TRAITS

This analysis did not yield any useful data, partially due to the poor condition of the skulls, partially due to the non-specific epigenetic traits (*Table 7.5*). The cranial sutures are without any special characteristics, *ossiculum*

pojav nastopa le pri starejših osebah, omejen je na regijo premolarjev in zlasti molarjev, pogosteje izpadejo zobje v mandibuli (tab. 7.6–7.8). Intenziteta kariesa predstavlja seštevek povprečnega števila karioznih zob in povprečnega števila ante mortem izpadlih zob na osebo. V povprečju pride na osebo 0,50 karioznih zob in 1,25 ante mortem izpadlih zob, intenziteta kariesa je 1,75. Intenziteta narašča s starostjo: v juvenilni dobi je 0, v obdobju adultus 1,00 (karies 0,50, AM 0,50), v obdobju matusus 2,67 (karies 0,67, AM 2,0).

### 7.2.6 PATOLOGIJA

Opazene patološke spremembe lahko razdelimo v tri kategorije.

Prva so degenerativne spremembe, ki smo jih opazili pri treh skeletih. Pri dveh moških okostjih so vidne degenerativne spremembe (*spondylosis deformans*) na ledvenih vretencih, vratna in prsna niso ohranjena. Verjetno so posledica normalnega procesa staranja, saj obe okostji sodita v starostno kategorijo matusus. Pri mlajšem od obeh skeletov (grob 4, 40–50 let) gre za začetno stopnjo spondiloze, pri starejšem (grob 1, 53–62 let) pa za močnejšo obliko. Pri ženskem skeletu iz groba 21 je vidna osteohondroza na korpusih vratnih in/ali zgornjih prsnih vretenc.

Druga kategorija so poškodbe oz. travma. Dva moška skeleta imata zacejeno poševno frakturo leve tibije. Pri skeletu št. 4 je zlom lociran na distalnem delu korpusa, pri skeletu št. 20 pa na sredini korpusa.

Tretjo kategorijo predstavljajo motnje v presnovi. *Cribra orbitalia* nastanejo zaradi pomanjkanja železa v krvi. Neaktivno obliko smo opazili pri dveh skeletih (moški št. 18, otrok št. 5) od enajstih, medtem ko pri sedmih okostjih orbite niso bile ohranjene. Frekvenca pojava je 20 % pri otrocih in 16,7 % pri odraslih.

Zanimiva je še izrazita lateralna asimetrija kosti zgornjih okončin pri skeletu št. 4. Leva ključnica in nadlahtnica sta bolj gracilni od desnih. Zaradi slabe ohranjenosti ni mogoče ugotoviti, ali gre za patologijo (atrofija) ali ne (preferenčna uporaba desne roke).

## 7.3 RAZPRAVA IN SKLEPI

V naselbini na Tonovcovem gradu je bilo ob stavbah in v njih evidentiranih 22 grobov z 18 človeškimi skeleti. Po arheološki dataciji sodi 14 skeletov v obdobje pozne antike, 4 pa v zgodnji srednji vek (grobovi 15, 18, 20, 22).

Prevladujejo otroška okostja, ki predstavljajo 55,5 % celotne skeletne serije oziroma 71,4 % poznoantične skeletne serije, saj so vsi otroški grobovi iz pozne antike. Delež otrok je visok, če ga primerjamo z deležem otroških okostij na skeletnih nekropolah, kjer ti navadno manjkajo iz različnih vzrokov. V kontekstu demograf-

*asticum* appears at a single skull and *sutura petrosquamosa* at all three male skulls that could be examined.

### 7.2.5 DENTAL CHARACTERISTICS

None of the skeletons show any anomalies in the morphology and growing pattern of the teeth. There are also no visible anomalies in the formation of dental enamel (linear hypoplasia). No caries was found on the teeth belonging to children, while adults revealed a low level of dental caries (Tables 7.6–7.8).

Three (out of the eight) adults had caries: the Late Antiquity male and female (graves 3 and 4, both *matusus*) and the Medieval female (grave 15, *adultus*). The frequency of dental caries was low, for from the 161 preserved teeth only 4 teeth (2.48 %) were marked by caries: two premolars in the maxilla of skeleton 15, and one molar and one premolar (respectively) in the mandibles of the other two skeletons. All four cases revealed the first stage of dental caries, the cavities measuring between 1 and 2 mm. The locations of the caries were different: in one example it was found on the tooth neck, in the other three on the crown.

During their lifetimes three out of the eight individuals lost some teeth: the previously mentioned Late Antiquity skeletons (graves 3 and 4, both *matusus*) and the Early Medieval female (grave 21, *adultus*). The total number of teeth that were lost ante mortem is 10 or 5.35 %, half of which were the first molars. The frequency of lost teeth is low, only the elderly lost them, and the loss was limited to the premolars and especially molars, most commonly from the mandible (Tables 7.6–7.8). The intensity of dental caries represents the total of the average number of caries teeth and the average number of teeth that fell out ante mortem (per individual). An average individual had 0.50 caries teeth and lost 1.25 teeth ante mortem, which makes the intensity of dental caries 1.75. The intensity increased with age: in the juvenile period it was 0, in the adult period 1.00 (caries 0.50, AM 0.50), and in the mature period 2.67 (caries 0.67, AM 2.0).

### 7.2.6 PATHOLOGY

The observed pathological changes can be divided into three categories.

The first are degenerative changes that were noticed in three skeletons. Two male skeletons showed degenerative changes (*spondylosis deformans*) on the lumbar vertebrae, while the cervical and thoracic vertebrae were not preserved. They are most likely a consequence of the normal aging process, as both skeletons belong into the *matusus* age group. The first stage of spondylosis was noticed in the younger of the two skeletons (grave 4, 40-



Sl. 7.3: Grob 4, moški, lobanja. Pogled od spredaj in s strani.  
Fig. 7.3: Grave 4, male, skull. Front and side view.

skih zakonitosti zgodovinskih populacij pa je tolikšna umrljivost otrok običajna. Tudi mortalitetna struktura otroških skeletov je v skladu z demografskimi zakonitostmi, saj je največ otrok umrlo v zgodnji otroški dobi, trije pred dopolnjenim 1. letom starosti.

Odraslih skeletov je 8, pri moškem iz groba 4 je pravilna določitev spola dvomljiva. Polovica je datirana v pozno antiko (3 moški, 1 ženska), polovica pa v zgodnji srednji vek (2 moška, 2 ženski). Med obema serijama obstaja razlika v starostni strukturi, saj so poznoantični prebivalci dočakali višjo starost kot zgodnjerednjeveški. O razlikah ne moremo razpravljati, saj jih zaradi majhnega števila skeletov ne moremo posplošiti na celotno populacijo. Lahko pa sklepamo, da spolna in starostna struktura obeh serij ne izstopata iz okvira, značilnega za zgodovinske populacije (Acsádi, Nemeskéri 1970, Leben-Seljak 1996a, Leben-Seljak 1996b, Leben-Seljak, Štefančič 1999).

50 years), while the elder (grave 1, 53-62 years) revealed that of a later stage. Osteochondrosis was noticed on the cervical and/or upper thoracic vertebrae of the female skeleton from grave 21.

The second category is represented by injuries or trauma. Two male skeletons have a healed diagonal fracture of the left tibia. Skeleton No. 4 revealed a fracture on the distal part of the corpus while skeleton No. 20 revealed a fracture in the middle of the shaft.

The third category is represented by metabolism disorders. *Cribra orbitalia* is a result of iron deficiency. From the total of eleven skeletons, two revealed the inactive form (male No. 18, child No. 5), while the orbits were not preserved at seven. The frequency is 20 % at children and 16.7 % at adults.

Interesting is also the pronounced lateral asymmetry of the bones of the upper extremities in skeleton No. 4. The left collar bone and humerus are more gracile than the right. Due to the poor condition it was impossible to ascertain whether this was a part of the pathology (atrophy) or not (preferential use of the right hand).

### 7.3 DISCUSSION AND CONCLUSIONS

22 graves with 18 human skeletons were discovered next to the buildings in the settlement on Tonovcov grad. According to archaeological dating 14 skeletons belong into Late Antiquity and 4 into the Early Medieval period (graves 15, 18, 20, 22).

Child skeletons prevail, for they represent 55.5 % of all skeletons or 71.4 % of Late Antiquity skeletons, for all children graves are dated into Late Antiquity. The share of children is high if we compare it to the share of child skeletons on skeleton necropoles, where they are most commonly not present due to various reasons. In the context of demographic rules of the historic populations such death rates are quite normal amongst children. The mortality structure of the child skeletons is in accordance to the demographic rules, for most children died in the early childhood, three in the infant stage before they reached the age of 1.

There are 8 adult skeletons, the sex of the one from grave 4 (defined as male) is questionable. Half were dated into Late Antiquity (3 male, 1 female), and half into the Early Medieval period (2 male, 2 female). There is a difference in the age structure between the two series, for in Late Antiquity the inhabitants lived longer than in the Early Medieval period. We cannot discuss the differences, for due to the low numbers of skeletons it is impossible to generalise them onto the entire population. We can assume that the sex and age structure of the two series does not stand out from the frame characteristic for historic populations (Acsádi, Nemeskéri 1970, Leben-Seljak 1996a, Leben-Seljak 1996b, Leben-Seljak, Štefančič 1999).



O telesnem videzu prebivalcev Tonovcovega gradu lahko povemo le malo. Okostja so bila zelo slabo ohranjena, kolikor toliko kompletni so bili samo trije moški skeleti, dva poznoantična in en zgodnjerednjeveški. Vsi trije imajo dolge in srednje široke lobanje, ki so po obliki ovoidne in hišaste ter na meji med mezokrajino in dolihokranijo. Razlike nastopajo v višini lobanje, karakteristikah obraza in telesni konstituciji. Dva moška sta si v teh značilnostih dokaj podobna: imata srednje visoko oz. visoko lobanjo, mezomandibularen obraz z ozkim leptorinim nosom, moški spolni znaki v predelu čela so slabo izraženi, postkranialne kosti so srednje krepke, po telesni višini 172 cm pa spadata v kategorijo visokih moških. Tretji moški pa ima nizko lobanjo, evrimandibularen obraz s široko mandibulo, močno izraženo glabelo in nadočasne oboke, zelo robustne postkranialne kosti in je s 167 cm nekoliko manjši od preostalih dveh.

Pri ženskih skeletih smo lahko izmerili le dve lobanji, ki datirata v zgodnji srednji vek in sta si precej različni. Ena je podobna tukajšnjim moškim lobanjam: je zelo dolga in srednje široka, mezokrana s tendenco k dolihokraniji, po obliki pa pentagonoidna in klinasta. Druga je krajša in širša, brahikrana s tendenco k hiperbrahikraniji, po obliki pa ovoidna in bombasta. Telesno višino smo lahko določili le eni poznoantični ženski, ki je bila visoka okrog 160 cm.

Ljudje, pokopani na Tonovcovem gradu, imajo torej lobanje na meji med dolihokranijo in mezokranijo in so visoke postave. To velja tako za poznoantično kot zgodnjerednjeveško serijo, saj izstopa le brahikrana lobanja zgodnjerednjeveške ženske. Analiza epigenetskih znakov, ki bi lahko pokazala na morebitne sorodstvene vezi prebivalcev ali pa na razlike med obema kronološkima serijama, ni dala uporabnih rezultatov, deloma zaradi slabe ohranjenosti lobanj, deloma pa zaradi nespecifičnih epigenetskih znakov.

Za primerjavo morfoloških karakteristik ljudi, živečih na območju današnje Slovenije v pozni antiki, imamo na voljo le malo podatkov. V preglednem članku o problemih poznoantične arheologije (Ciglenečki 1999) je sicer omenjenih precej najdišč, žal pa je le malokatero od njih raziskano tudi z antropološkega vidika. Tista, ki so, pa imajo enako kot Tonovcov grad le malo okostij, ki so praviloma slabo ohranjena. Ciglenečki je grobišča razdelil v dve kronološki skupini. V prvi je 12 grobišč iz 4. in prve polovice 5. stoletja, antropološko sta obdelani le dve izmed njih. Nekropola Ajdovski gradec nad Vranjem pri Sevnici je bila obdelana v okviru diplomske naloge, izsledki analize 49 okostij pa so pomanjkljivi in za primerjavo neuporabni, deloma zaradi slabe ohranjenosti okostij, deloma pa zaradi neizkušenosti študentov (Orožen-Adamič *et al.* 1975). Na Puščavi pri Starem trgu je bilo evidentiranih 138 grobov, ohranjenih pa je le 53 nepopolnih okostij, večinoma lobanje brez obraznega dela, zaradi česar podatkov o telesni višini nimamo.

Little can be said as regards the visual appearance of the inhabitants from Tonovcov grad. The skeletons were in poor condition, with only three male skeletons more or less complete (two Late Antiquity ones and one Early Medieval one). All three have long and medium wide skulls that are ovoid and house shaped and according to cranial index they fall between the categories of *mesocrania* and *dolichocrania*. The differences appear in the height of the skull, the face characteristics and in the body constitution. Two men were rather similar in these characteristics: they had a medium high or high cranium, a mesomandibular face with a narrow leptorrhine nose, the male sexual traits in the forehead area were poorly pronounced, the postcranial bones were averagely strong, and with a body height of 172 cm they were tall for the period. The third male had a low skull, a eurymandibular face with a wide mandible, a pronounced glabella and superciliary arches, robust postcranial bones and with 167 cm he was slightly smaller than the other two.

From the female skeletons only two skulls could be measured, both of which were dated into the Early Medieval period and differ greatly. One is similar to the male skulls found at this location: it is very long and medium wide, mesocranial with a tendency towards dolichocranial, in its shape pentagonoid and wedge like. The second is shorter and wider, brachycranial, almost hyper-brachycranial, and ovoid and bomb like in its shape. The body height could be defined merely for one Late Antiquity female, who was approximately 160 cm tall.

All of the individuals who were buried at Tonovcov grad were tall in stature and had skulls somewhere on the border between dolichocranial and mesocranial. This was true in Late Antiquity as well as in the Early Medieval period, for only the Early Medieval female stands out because of hyperbrachicrania. The analysis of epigenetic traits that could indicate the eventual relations ties between the inhabitants (or the differences between the two chronological series) failed to yield any useful results - partially due to the poor condition of the skulls, partially due to the non-specific epigenetic traits.

The data that could be used in the comparison of morphological characteristics of people who lived in the area of present day Slovenia during Late Antiquity is rather limited. The article that overviews the problems of Late Antiquity archaeology (Ciglenečki 1999) mentions a number of sites, unfortunately very few were researched from the anthropological aspect. Those that were are similar to Tonovcov grad in the fact that they have only a few skeletons, and most were found in a poor condition. Ciglenečki divided the burial sites into two chronological groups. The first one consists of 12 grave sites dating to the 4<sup>th</sup> and first half of the 5<sup>th</sup> century, only two of which were anthropologically treated. The necropolis Ajdovski gradec above Vranje near Sevnica was treated within a graduation thesis, and the results of



Sl. 7.4: Obraba zob: grobova 1 in 4.  
Fig. 7.4: Dental wear: graves 1 and 4.

Nekropola je bila v uporabi v dokaj širokem časovnem obdobju, od 5. do 9. stoletja, v nedvomno poznoantični čas so po grobnih pridatkih opredeljene le 4 ženske in 1 moška lobanja (Leben-Seljak 2004).

Druga skupina 26 grobišč datira v konec 5. stoletja in v celotno 6. stoletje. Na 16 lokacijah so bili odkriti le posamezni skeleti, nobeno od grobišč ni antropološko obdelano. Posebno skupino predstavlja 5 najdišč, kjer so bili grobovi najdeni v cerkvah ali poleg njih. V to zadnjo skupino sodijo poleg grobov na Tonovcovem gradu še grobovi z Ajdne, sarkofag z Rifnika ter grobovi s Korinjskega hriba in Kučarja. Antropološko je obdelanih 6 otroških in 5 odraslih okostij z Ajdne nad Potoki (Leben-Seljak 1995, 1996a) ter oba skeleta iz sarkofaga na Rifniku (Leben-Seljak 2006). Na preostalih petih lokacijah so bila odkrita večja grobišča, antropološko so bila pregledana vsa z izjemo nekropole Kranj – križišče Iskra. Žal pa se nobeno izmed štirih analiziranih grobišč ne more pohvaliti z dobro ohranjenostjo okostij. Rifnik pri Celju ni izpolnil pričakovanj, da bi lahko postal referenčna serija za pozno antiko. Med arheološkimi izkopavanji je bilo sicer odkritih 109 skoraj kompletnih skeletov, vendar pa se je ohranilo le 56 lobanj, za večino katerih se ne ve, iz katerega groba izvirajo, pravilna določitev spola pa je vprašljiva (Leben-Seljak 2006). Na Pristavi I na Bledu je

the analysis of the 49 skeletons are lacking and cannot be used for comparison: partially due to the poor condition of the skeletons and partially due to the inexperience of the students (Orožen-Adamič *et al.* 1975). 138 graves were discovered at Puščava near Stari trg, however only 53 incomplete skeletons were preserved, mainly skulls without the facial part, which leaves us without any data on the body heights. Beside that the necropolis was in use during a relatively long period of time, between the 5<sup>th</sup> and the 9<sup>th</sup> century, and based on the grave goods only 4 female and 1 male skulls can be reliably placed into the Late Antiquity period (Leben-Seljak 2004).

The second group of 26 sites is dated into the end of the 5<sup>th</sup> century and during the entire 6<sup>th</sup> century. Single skeletons were discovered on 16 locations, however none were anthropologically treated. The 5 sites in which graves were found in the churches or alongside them form a special group. This group consists of the graves on Tonovcov grad, the graves on Ajdna, the sarcophagus from Rifnik and the graves on Korinjski hrib and Kučar. 6 child and 5 adult skeletons from Ajdna above Potoki (Leben-Seljak 1995, 1996a) and both skeletons from the sarcophagus from Rifnik (Leben-Seljak 2006) were anthropologically treated. On the remaining five locations cited by Ciglenečki larger cemeteries were discovered and all with the exception of the necropolis Kranj - Iskra Crossroads were anthropologically studied. Unfortunately, none of the four analysed burial sites revealed skeletons in a good condition. Rifnik did not fulfil the expectations of becoming a referential series for Late Antiquity. During archaeological excavations 109 almost complete skeletons were discovered, however only 56 skulls were preserved, and for most of them it is unknown as to which grave they originate from, and the sex determination is questionable (Leben-Seljak 2006). 147 graves were discovered on Pristava I at Bled, however only 64 remain preserved until today (12 of which held child skeletons). All of them belonged to Romanised autochthonous population (Leben-Seljak 1996a). From the vast necropolis at Lajh in Kranj, where over 700 graves were destroyed between 1898 and 1905, only the remains of 73 skeletons have been preserved. This series is very heterogeneous and represents a part of the ethnically mixed population of autochthonous settlers, Germans, Ostrogoths, Allemans and Lombards, all of whom lived in the Late Antiquity fort of Carnium during the 6<sup>th</sup> century (Kiszely 1979). During the protective archaeological excavation at Lajh (2004 and 2005) archaeologists discovered another 14 graves with relatively well preserved skeletons, all of which have been anthropologically treated (Leben-Seljak, unpublished results). The excavations continued in 2007 (144 graves, 58 of which were anthropologically documented during the fieldwork, and all are in the process of a detailed anthropological analysis) and in 2009, when a preliminary anthropological analysis of 84 intact graves and approximately 200 destroyed graves was carried out

bilo odkritih 147 grobov romaniziranih staroselcev, vendar se jih je do danes ohranilo le 64, od tega 12 otroških (Leben-Seljak 1996a). Od obsežne nekropole na Lajhu v Kranju, kjer je bilo med letoma 1898 in 1905 uničenih več kot 700 grobov, so se ohranili le ostanki 73 okostij. Serija je zelo heterogena in predstavlja del etnično mešane populacije staroselcev, Germanov, Ostrogotov, Alemanov in Langobardov, ki so v 6. stoletju živeli v poznoantični utrdbi *Carnium* (Kiszely 1979). Leta 2004 in 2005 so arheologi ob zaščitnih izkopavanjih na Lajhu odkrili še 14 grobov z dokaj dobro ohranjenimi okostji, ki so že antropološko obdelana (Leben-Seljak, neobjavljeni rezultati). Izkopavanja so se nadaljevala v letu 2007 (144 grobov, na terenu jih je bilo antropološko dokumentiranih 58, vsi pa so trenutno v fazi podrobne antropološke analize) in v letu 2009, ko je bila na terenu izdelana preliminarna antropološka analiza 84 intaktnih grobov ter približno 200 uničenih grobov (Leben-Seljak, neobjavljeni podatki). V vzhodnogotsko obdobje, to je v prvo polovico 6. stoletja, sodi tudi najdišče Ljubljana Dravlje, ki tudi pripada etnično mešani populaciji. Del nekropole je bil zaradi gradbenih posegov uničen, objavljeni so podatki o spolu, starosti in morfoloških karakteristikah 49 okostij, od katerih je 10 otroških. Analiza skeletov ni izdelana v povezavi z arheološkimi izsledki, za celotno serijo pa je značilen precejšen delež (13) umetno preoblikovanih lobanj (Tomazo-Ravnik 1975).

Poleg lokacij, ki jih omenja Ciglencečki v pregledu grobišč, so bila v zadnjem času antropološko obdelana še tri. V enem primeru gre za osamljeno žensko okostje iz sarkofaga z Zidanega Gabra na Gorjancih (Breščak et al. 2002), medtem ko serija z Vrajka šteje 17 okostij, ki izvirajo iz delno uničene nekropole na lokaciji divjega peskokopa pri Gorenjem Mokronogu (Leben-Seljak 2003). V okviru temeljnega raziskovalnega projekta je bilo analizirano tudi grobišče Dobova – Humek z 29 skeletnimi grobovi iz 4. do začetka 9. stoletja (Leben-Seljak 2008), vendar pa rezultati še niso objavljeni.

Ta malo daljši uvod je pojasnilo, zakaj smo lahko primerjali le kranialni indeks in telesno višino moških s štirih poznoantičnih najdišč (sl. 7.1–7.2). V kranialnem indeksu Tonovcov grad ne izstopa, saj tudi primerjalne skeletne serije z Ajdne, Pristave I in Vrajka izkazujejo prevlado mezokranialnih in dolihokranialnih lobanj. V slovenskem prostoru so take lobanje tipične tako za zgodnjemedievalna grobišča, ki so v kranialnem indeksu dokaj homogena, kot tudi za poznoantična, ki pa so bolj heterogena. Brahikrane lobanje so v obeh kronoloških obdobjih redke, vendar pa se pojavljajo skoraj na vseh grobiščih. Škerlj je menil, da bi bila brahikranija lahko značilnost predantičnega avtohtonega prebivalstva (Škerlj 1953), vendar pa nove raziskave kažejo, da bi lahko šlo tudi za tuj element, ki je k nam prišel z vzhoda. To domnevo bi morda lahko potrdila antropološka analiza grobišča v Batujah iz 9.–11. stoletja, ki je po dosedanjih podatkih edino najdišče, na katerem prevladujejo brahikrane lobanje (Martinc et al. 1972).

during the fieldwork (Leben-Seljak, unpublished data). The site Ljubljana Dravlje belongs to the Eastern Gothic period (1<sup>st</sup> half of the 6<sup>th</sup> century), and this also revealed an ethnically mixed population. A part of the necropolis was destroyed by the building, however the data on the sex, age and morphological characteristics of 49 skeletons (10 of which are male) was published. The analysis of the skeletons was not concluded in relation to archaeological discoveries, and for the entire series a relatively large share of artificially reshaped skulls (13) is characteristic (Tomazo-Ravnik 1975).

Alongside the locations that have been mentioned in Ciglencečki's overview another three sites have recently been anthropologically treated. One was a solitary female skeleton from the sarcophagus found in Zidani Gaber on Gorjanci (Breščak et al. 2002). The second is the series from Vrajk that consists of 17 skeletons that originate from the partially destroyed necropolis on the location of the illegal sandpit at Gorenji Mokronog (Leben-Seljak 2003). Within the frame of the research project financed by The Slovenian Research Agency (Agencija za raziskovalno dejavnost Republike Slovenije) the burial site Dobova – Humek with 29 skeleton graves dated between the 4<sup>th</sup> and the end of the 9<sup>th</sup> century was also analysed (Leben-Seljak 2008), however the results have not been made public yet.

This slightly longer introduction is an explanation as to why was it possible to compare merely the cranial index and the body height of the males from four Late Antiquity sites (Figs. 7.1–7.2). Tonovcov grad does not stand out as regards the cranial index, for the comparable skeletons from Ajdna, Pristava I and Vrajk show a domination of mesocranial and dolichocranial skulls. In the area of present day Slovenia such skulls are characteristic for Early Medieval cemeteries, which are relatively homogeneous in the cranial index, as well as the Late Antiquity ones, which are more heterogeneous. Brachicranial skulls are rare in both chronological periods, however single ones can be found almost in all burial sites. Škerlj was of the opinion that the *brachicrania* was characteristic of pre-Antiquity settlers (Škerlj 1953), however newer research indicates, that this could also be a foreign element that arrived from the east. This assumption could be confirmed by the anthropological analysis of the grave in Batuje, dated between the 9<sup>th</sup> and 11<sup>th</sup> century, which is the only site, in which brachicranial skulls prevail (according to the data so far; Martinc et al. 1972).

According to their body height the inhabitants of Tonovcov grad were amongst the tallest ones in their time. The graves of Early Medieval Slavs were more likely to reveal tall skeletons, while Late Antiquity graves tended to reveal more heterogeneous graves than the Early Medieval ones also as regards this characteristic. Members of Germanic tribes were especially tall. Kiszely (1979) stated the average height of 171.1 cm for male and 161.6 cm for female Lombards, and in the site of Lajh 171.6 cm for males and 162.3 cm for females.

Po telesni višini so prebivalci Tonovcovega gradu med višjimi. Visoka telesna višina je značilna predvsem za zgodnj srednjeveška grobišča starih Slovanov, medtem ko so poznoantična grobišča tudi v tej karakteristiki precej bolj heterogena kot zgodnj srednjeveška. Visoki so bili predvsem pripadniki germanskih plemen. Kiszely (1979) navaja za Langobarde povprečno telesno višino 171,1 cm za moške in 161,6 cm za ženske, za najdišče Lajh pa 171,6 cm za moške in 162,3 cm za ženske. Žal pa je ta izračunana po Breitinger-Bachovi metodologiji, ki daje višje rezultate kot Manouvrierjeva metoda in zato onemogoča neposredne primerjave. Tudi vsa okostja, odkrita na Lajhu leta 2004, kažejo na dokaj visoke telesne postavbe: štiri ženske so bile visoke med 161 in 165 cm, med štirimi moškimi pa so trije merili med 169 in 172 cm in eden 165 cm (Leben-Seljak, neobjavljeno). Na najdiščih, ki so arheološko opredeljena kot grobišča romaniziranih staroselcev, prevladujejo ljudje nižjih postav, visoka telesna višina je značilna le za redke posameznike. Edina do sedaj izvedena primerjalna analiza kaže, da je prav telesna višina tista značilnost, ki razlikuje poznoantične in zgodnj srednjeveške prebivalce na območju Bleda (Leben-Seljak 2000).

Vsi skeleti imajo dokaj zdrave zobe, anomalij v morfologiji in izražanju zob ter anomalij v formiranju zobne sklenine ni. Otroški skeleti nimajo kariesa, pri odraslih pa je frekvenca karioznih zob (2,48 %) in ante mortem izpadlih zob (5,35 %) nizka. Oba pojava sta omejena ne regijo molarjev in premolarjev. Ante mortem izpad zob je verjetno posledica napredne oblike kariesa, saj znakov parodontalnih obolenj ni. Po pričakovanju intenziteta kariesa narašča s starostjo. Primerjava med poznoantično in zgodnj srednjeveško serijo zaradi majhnega števila skeletov in različne starostne strukture obeh serij ni možna, vendar pa se zdi, da med njima ni bistvenih razlik. Nizka stopnja kariesa je verjetno posledica naravnega načina prehrane, ki je domnevno vsebovala veliko vlaknin in žit v nepredelani obliki. Na to kažeta tudi precej močna obraba zob in odsotnost zobnega kamna.

Dobro stanje zobovja v poznoantični seriji nekoliko preseneča. Dosedanje raziskave so kazale, da so imeli prebivalci slovenskega prostora vse do prihoda Slovanov precej visoko stopnjo kariesa. To pravilo je zaznal že Krušič (1970–1971). Ista tendenca se je pokazala tudi pri blejskih grobiščih, kjer imajo skeleti s staroselske Pristave I več kariesa kot pa skeleti iz zgodnj srednjeveških nekropol (Leben-Seljak 1996a). Podobno velja tudi za nekropolo Brezje pri Zrečah, kjer imajo poznoantični skeleti kar 14,8 % karioznih zob, zgodnj srednjeveški pa le 4 % (Leben-Seljak, Štefančič 2001). Nove raziskave, ki postopno povečujejo bazo podatkov o skeletih, potrjujejo nizko stopnjo kariesa v zgodnj srednjeveškem obdobju, vendar pa kažejo, da so med posameznimi najdišči poznoantičnega obdobja precejšnje razlike.

Unfortunately this was calculated with the use of the Breitinger-Bach methodology, which gives higher results than the Manouvrier method and does thus not enable direct comparison. All skeletons discovered at Lajh in 2004 revealed relatively tall individuals: four females measured between 161 and 165 cm, and from the four males three were between 169 and 172 cm tall while one was 165 cm tall (Leben-Seljak, unpublished). On sites that were archeologically defined as grave sites of Romanised autochthonous settlers, people of a lower stature prevail, and only a few tall individuals were found. The only comparative analysis performed so far shows that the body height is the characteristic that differentiates between the Late Antiquity and Early Medieval inhabitants of the Bled area (Leben-Seljak 2000).

All skeletons have relatively healthy teeth; there were no anomalies in their morphology or eruption, nor in the formation of the enamel. The child skeletons do not have any dental caries, while amongst the adults the frequency of teeth with caries (2.48 %) and teeth that fell out ante mortem (5.35 %) is low. Both occurrences are limited to the region of molars and premolars. As there are no traces of periodontal disease ante mortem tooth loss is most likely a result of the late stages of dental caries. As expected the intensity of dental caries increases with age. Due to the low numbers of skeletons and the different age structure it was impossible to compare the Late Antiquity and Early Medieval series, however it seems that there are no larger differences between the two. The rarity of dental caries is most likely a consequence of the diet, which most likely contained a lot of fibre and wheat in unprocessed forms. This is also indicated by the relatively strong tooth wear and the lack of calculus.

The good condition of teeth in the Late Antiquity series is somewhat surprising. Until now research has indicated that the inhabitants of present day Slovenia had a high level of dental caries until the Slavs arrived. This rule was noticed already by Krušič (1970–1971). The same tendency could be noticed on the necropolises from Bled, where the skeletons from the autochthonous settlers (Pristava I) had more dental caries than the skeletons from the Early Medieval necropolises (Leben-Seljak 1996a). Similar holds true for the necropolis Brezje near Zreče, where Late Antiquity skeletons have as much as 14.8 % of teeth with caries, while this share at the Early Medieval skeletons is much lower with a mere 4 % (Leben-Seljak, Štefančič 2001). The new researches which are gradually increasing the skeleton database, confirm the low level of dental caries in the Early Medieval period, however they also show large differences between individual Late Antiquity sites. Apart from Tonovcov grad low caries frequency was also found at Ajdna and Ptuj (Table 7.8).

There were also not many pathological changes, which is a general characteristic of all anthropologi-

Poleg Tonovcovega gradu imata npr. nizko frekvenco kariesa tudi Ajdna in Ptuj (tab. 7.8).

Tudi patoloških sprememb ni veliko, kar je splošna značilnost vseh antropološko preučenihi najdišč v Sloveniji. Na okostjih dveh moških so vidne degenerativne spremembe (*spondylosis deformans*) na ledvenih vretencih, ki so verjetno posledica normalnega procesa staranja. Osteohondroza na vratnih in/ali zgornjih prsnih vretencih pri ženski iz groba 21 pa je verjetno posledica telesne aktivnosti, morda nošenja težjih bremen na glavi. Podobno patologijo smo opazili tudi pri ženskah z Vrajka (Leben-Seljak 2003). Dva moška skeleta imata zaceljeno poševno frakturo leve tibije (grobova 4 in 20). Za skelet št. 4 je značilna izrazita lateralna asimetrija zgornjih okončin, vendar zaradi slabe ohranjenosti ni mogoče ugotoviti, ali gre za nepatološko spremembo, katere vzrok je preferenčna uporaba desne roke, ali pa za atrofijo kot posledico začasne ali stalne nezmožnosti premikanja leve roke, npr. zaradi zloma podlahti. *Cribra orbitalia* nastopajo v neaktivni obliki pri dveh skeletih, frekvenca pojava je 20 % pri otrocih in 16,7 % pri odraslih. Verjetno gre za posledico prebolele infekcije ali anemije, ki pa ni bila vzrok smrti. Drugih patoloških sprememb, ki bi jih lahko pripisali preživelim stresnim situacijam, kot so npr. podhranjenost in infekcijske bolezni, ni.

cally studied sites in Slovenia. Two male skeletons revealed degenerative changes (*spondylosis deformans*) on the lumbar vertebrae, and these were most likely a consequence of normal aging. The osteochondrosis discovered on the cervical and/or upper thoracic vertebrae of the female from grave 21 is most likely a consequence of physical activity, possibly a result of carrying heavy loads on the top of her head. A similar pathology has been noticed amongst the females from Vrajka (Leben-Seljak 2003). Two male skeletons have a healed diagonal fracture of the left tibia (graves 4 and 20). A pronounced lateral asymmetry of the upper extremities is characteristic of skeleton No. 4, however due to their poor condition it is impossible to ascertain whether this was a non-pathological change, the cause of which could be the preferential use of the right hand, or an atrophy as a consequence of a temporal or permanent incapability to move the left arm, e.g. due to a broken forearm. *Cribra orbitalia* appears in its inactive form in two skeletons, with a frequency of 20 % amongst children and 16.7 % amongst adults. This is most likely a consequence of a survived infection or an anaemia which was not the cause of death. There are no other pathological changes that could be ascribed to stressful situations, such as for instance malnutrition or inflectional diseases.

#### 7.4 LITERATURA / BIBLIOGRAPHY

Tonovcov grad. Naselbinski ostanki in interpretacija / Tonovcov grad. Settlement remains and interpretation = Ciglencečki, Modrijan, Milavec 2011.

ACSÁDI, G. in / and J. NEMESKÉRI 1970, *History of Human Life Span and Mortality*. – Budapest.

AUFDERHEIDE, A. C. in / and C. RODRÍGUEZ-MARTÍN 1998, *The Cambridge Encyclopedia of Human Paleopathology*. – Cambridge.

BREŠČAK D., M. LOVENJAK, T. VERBIČ in / and P. LEBEN-SELJAK 2002, Nov poznoantični grob z Zidanega gabra na Gorjancih. – *Arheološki vestnik* 53, 223–232.

BROTHWELL, D. R. 1972, *Digging up Bones*. – London.

CHIARELLI, A. B. (ur. / ed.) 1980, Recommendations for Age and Sex Diagnoses of Skeletons. – *Journal of Human Evolution* 9, 517–549.

CIGLENEČKI, S. 1999, Results and Problems in the Archaeology of the Late Antiquity in Slovenia. / *Izsledki in problemi poznoantične arheologije v Sloveniji*. – *Arheološki vestnik* 50, 287–309.

CIGLENEČKI, S., Z. MODRIJAN in / and T. MILAVEC 2011, *Tonovcov grad. Naselbinski ostanki in*

*interpretacija / Tonovcov grad. Settlement remains and interpretation*. – Opera Instituti Archaeologici 23.

HAUSER, G. in / end G. F. DE STEFANO 1989, *Epigenetic Variants of the Human Skull*. – Stuttgart.

HILLSON, S. 1996, *Dental Anthropology*. – Cambridge.

KEY, C. A., AIELLO, L. C. in / and T. MOLLESON 1994, Cranial Suture Closure and Its Implications for Age Estimation. – *International Journal of Osteoarchaeology* 4, 193–207.

KISZELY, I. 1979, *The Anthropology of the Lombards*. BAR. International Series 6i. – Oxford.

KROGMAN, W. M. in / and M. Y. İŞCAN 1986, *The human skeleton in forensic medicine*. – Springfield.

KRUŠIČ, V. 1970–71, Karies pri narodih, živečih na Slovenskem, gledan skozi prizmo tisočletij. – *Arheološki vestnik* 21–22, 225–236.

KRUŠIČ, V. 1971, Karies pri Langobardih, živečih na ozemlju današnje Slovenije. – *Zobozdravstveni vestnik* 26, 4–6, 137–151.

LEBEN-SELJAK, P. 1995, Antropološka analiza poznoantičnih skeletov z Ajdne nad Potoki. – *Jeseniški zbornik* 7, 237–250.

LEBEN-SELJAK, P. 1996a, *Antropološka analiza poznoantičnih in srednjeveških grobišč Bleda in okolice*.

– Neobjavljena doktorska disertacija / Unpublished doctoral thesis, Univerza v Ljubljani, Ljubljana.

LEBEN-SELJAK, P. 1996b, Paleodemografska analiza nekropole pri farni cerkvi v Kranju. – *Antropološki zvezki* 4, 95–107.

LEBEN-SELJAK, P. 2000, Etnogeneza Slovencev: rezultati antropoloških raziskav. V / In: R. Bratož (ur. / ed.) *Slovenija in sosednje dežele med antiko in karolinško dobo*, Situla 19, 549–558.

LEBEN-SELJAK, P. 2003, Antropološka analiza poznoantične nekropole na Vrajku v Gorenjem Mokronogu. – *Arheološki vestnik* 54, 397–420.

LEBEN-SELJAK, P. 2004, Antropološka analiza skeletov s Puščave nad Starim trgom pri Slovenj Gradcu. – *Arheološki vestnik* 55, 527–564.

LEBEN-SELJAK, P. 2006, Antropološka analiza poznoantične skeletne serije z Rifnika. – *Arheološki vestnik* 57, 427–455.

LEBEN-SELJAK, P. 2008, *Zaključno poročilo o rezultatih raziskovalnega projekta 2005–2008. Antropološka analiza izbranih antičnih arheoloških najdišč Slovenije*. – Arhiv Inštituta za arheologijo ZRC SAZU, Ljubljana.

LEBEN-SELJAK, P. in / and M. ŠTEFANČIČ 1999, Adult mortality and biodynamic characteristics in the early Middle Ages population at Bled, Slovenia. – *Variability and Evolution* 7, 65–77.

LEBEN-SELJAK, P. in / and M. ŠTEFANČIČ 2001, Dental caries in skeletal samples from northeastern Slovenia. – *Anthropological notebooks* 7, 84–99.

MARTIN, R. in / and K. SALLER 1957, *Lehrbuch der Anthropologie I*. – Stuttgart.

MARTINC, A., ZORC, M. in / and ZUPANC, D. 1972, *Antropološka obdelava staroslovanskega grobišča v Batujah*. Diplomaska naloga / Undergraduate thesis, Oddelek za biologijo, Biotehniška fakulteta, Univerza v Ljubljani, Ljubljana.

OROŽEN-ADAMIČ, A., M. ZORC in / and D. ZUPANC 1975, Antropološka obdelava izkopanega gradiva. – V / In: PETRU, P. in / and T. ULBERT, *Vranje pri Sevnici*. Katalogi in monografije 12, 117–122.

ROGERS, J. in / and T. WALDRON 1994, *A Field Guide to Joint Disease in Archaeology*. – Chichester.

STEELE, D. G. 1976, The Estimation of Sex on the Basis of the Talus and Calcaneus. – *American Journal of Physical Anthropology* 45, 581–588.

STEINBOCK, R. T. 1976, *Paleopathological Diagnosis and Interpretation*. – Springfield.

ŠKERLJ, B. 1953, Srednjeveška okostja z Bleda, izkopana leta 1949. – *Razprave I. razreda SAZU* 3, 313–55.

ŠKERLJ, B. in / and Z. DOLINAR 1950, Staroslovanska okostja z Bleda. – V / In: KASTELIC, J. in / and B. ŠKERLJ, *Slovanska nekropola na Bledu*. – Dela SAZU 1. raz. 2.

TOMAZO-RAVNIK, T. 1975, Dravlje – antropološka obdelava osteološkega gradiva. – V / In: Slabe M., *Dravlje: grobišče iz časov preseljevanja ljudstev / Dravlje: necropoli dall' epoca della migrazione dei popoli*, Situla 16, 143–153.

## 8. SESALSKA MAKROFAVNA

### 8. MAMMALIAN MACROFAUNA

Borut TOŠKAN, Janez DIRJEC

Tonovcov grad leži na naravno dobro zavarovanem, 412 m visokem hribu severno od Kobarida (*sl. 8.1*). Prva poselitev na tem mestu sega v prazgodovino in je dokumentirana s posameznimi najdbami artefaktov brez ostalin naselbinskih struktur (glej Tonovcov grad. Naselbinski ostanki in interpretacija, pogl. 2.2). Iz tega obdobja so maloštevilni tudi živalski ostanki, saj v prazgodovinski kontekst sodijo le po en fragment goveje koželjnice in golenice ter zgornji meljak drobnice. Naslednja z naselbinskimi ostanki izpričana poselitev Tonovcovega gradu je že poznoantična in obsega več faz.<sup>1</sup> V tem obdobju je spričo svoje strateške lege širše območje Kobarida igralo pomembno vlogo. Tod je namreč tekla rimska cesta, ki je čez prelaz Predil povezovala Čedad/*Forum Iulii* z naselbinami na Koroškem (Šašel 1975, 76; Bosio 1991, 193; Ciglencečki 1997a, 188). Še posebej pomembna je bila prav vloga naselbine na Tonovcovem gradu, ki je v tistem obdobju predstavljala središče območja, zamejenega z rekama Nadižo in Sočo (Ciglencečki 1997b; 2005). Več tisoč sesalskih kosti in zob iz poznoantičnih plasti Tonovcovega gradu tako ponuja izvrstno priložnost za poglobljen vpogled v ekonomijo in prehranske navade prebivalcev lokalnega središča na območju jugovzhodnih Alp v obdobju od druge polovice 4. do začetka 7. stoletja, v luči najdb iz zgodnjersrednjeveške faze (okvirno datirane med 7. in 9. stoletje; glej Tonovcov grad. Naselbinski ostanki in interpretacija, pogl. 2.2) pa tudi v morebitne spremembe, ki so jih v ta prostor vpeljali priseljenci z vzhoda.

#### 8.1 MATERIAL IN METODE

Izkopavanja na Tonovcovem gradu so potekala med letoma 1993 in 2005. Podrobne podatke o najdišču in metodologiji terenskega raziskovanja podajajo Ciglencečki, Modrijan in Milavec (Tonovcov grad. Naselbinski

<sup>1</sup> Časovni okvir posameznih faz (Tonovcov grad. Naselbinski ostanki in interpretacija, pogl. 2.2): prva poznoantična faza = PA 1 (2. polovica 4. in začetek 5. st.), druga poznoantična faza = PA 2 (od konca 5. do začetka 7. st.) in zgodnjersrednjeveška faza = ZSV (okvirno 7. do 9. st.).

Tonovcov grad lies on a naturally well protected, 412 m high hill north of Kobarid (*Fig. 8.1*). Individual finds indicate that a settlement was located at this location already in prehistoric times, however no settlement structure remnants were discovered from this period (see Tonovcov grad. Settlement remains and interpretation, chapter 2.2). Animal remains are also rare, for only one fragment of a cattle radius and tibia and the upper molar of a sheep or goat originate from the prehistoric context. Tonovcov grad was settled again in Late Antiquity and this settlement can be divided into two phases; in addition to this an Early Medieval phase has been also established.<sup>1</sup>

Due to its strategic location the broader Kobarid area played an important role during the aforementioned period. This territory was crossed by the Roman road leading across the Predil pass and connecting *Forum Iulii* with settlements in Carinthia (Šašel 1975, 76; Bosio 1991, 193; Ciglencečki 1997a, 188). The role of the settlement at Tonovcov grad was especially important, as it represented the centre of the area marked by the Nadiža and Soča rivers at the time (Ciglencečki 1997b; 2005). Several thousand mammalian bones and teeth from the Late Antique layers at Tonovcov grad offer an excellent opportunity for an insight into the economy and diet of the inhabitants of this local centre in the southeast Alps between the second half of the 4<sup>th</sup> century and the beginning of the 7<sup>th</sup> century. The finds from the Early Medieval phase (7<sup>th</sup> to 9<sup>th</sup> century; see Tonovcov grad. Settlement remains and interpretation, chapter 2.2) also offer an insight into the eventual changes that were introduced into the area by the "Barbarians" from the east.

<sup>1</sup> The time frames of the individual phases (Tonovcov grad. Settlement remains and interpretation, chapter 2.2): Late Antiquity phase 1 = LA 1 (2<sup>nd</sup> half of 4<sup>th</sup> century, beginning of 5<sup>th</sup> century), Late Antiquity phase 2 = LA 2 (end of 5<sup>th</sup> century to beginning of 7<sup>th</sup> century) and Early Medieval phase = EMA (approx. 7<sup>th</sup> to 9<sup>th</sup> century).

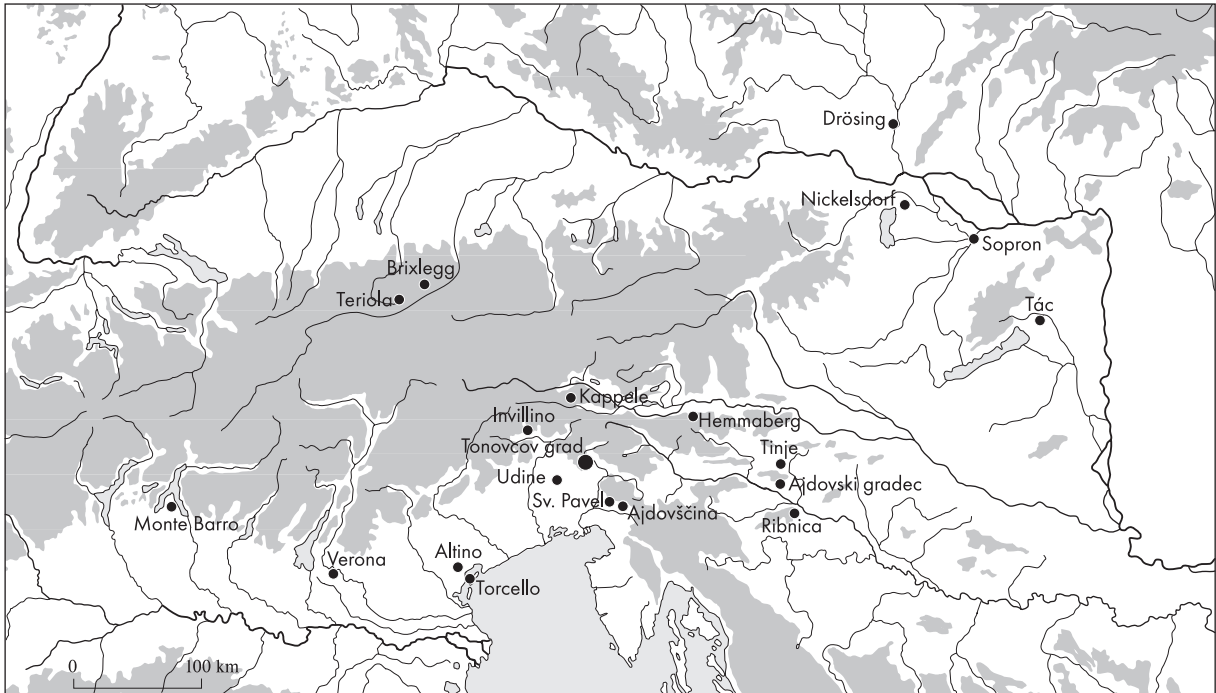

Sl. 8.1: Lega Tonovcovega gradu in ostalih v besedilu pogosteje omenjenih najdišč.

Fig. 8.1: The position of Tonovcov grad and other sites that are commonly mentioned in the text.

ostanki in interpretacija, pogl. 1.3, 2.1), zato se na tem mestu posvečava le predstavitvi arheozoološke analize. Favniški ostanki so bili pobirani ročno, le deloma je bil izkopan sediment tudi (suho) presejan skozi sito.<sup>2</sup> Zaradi tega je delež manjših kosti in zob ter kostnih/zobnih drobcov v vzorcu nekoliko podcenjen (tab. 8.19). Kvantitativne primerjave med taksoni temeljijo na številu določenih primerkov (*Number of Identifiable Specimens*, NISP). Pri tem sva fragmente, ki nedvoumno pripadajo isti kosti (npr. drobcu med arheološkimi izkopavanji razbitih kosti), združila in jih štela kot en primerek (tj. NISP = 1). Ob najmanjšem številu določenih primerkov sva v okviru nekaterih analiz uporabila tudi podatek o najmanjšem številu osebkov (*Minimum Number of Individuals*, MNI).<sup>3</sup> Pri izračunu MNI za posamezen skeletni element sva v primerih, ko se ta v skeletu pojavlja v paru, upoštevala podatek o abundanci elementa številčno bolj zastopane anatomske strani. K tej številki sva nato prištela še vse fragmente istega skeletnega elementa nasprotne anatomske strani, za katere je bilo ugotovljeno, da nedvoumno pripadajo drugim živalim (tj. živalim drugačne starosti ali nasprotnega spola).

Pri biometrični študiji sva sledila smernicam von den Driescheve (1976). Zaradi pogosto skromnega števila merljivih ostankov posameznega skeletnega ele-

<sup>2</sup> Dolžina stranice kvadratno oblikovanih luknjic na situ je merila 1 cm.

<sup>3</sup> Za diskusijo o prednostih in slabostih posameznih kazalnikov abundance najdb glej npr. Gautier (1984), Grayson (1984), Grayson, Frey (2004).

## 8.1 MATERIALS AND METHODS

The excavations at Tonovcov grad took place between 1993 and 2005. Detailed information as regards the site and the fieldwork research methodology were given by Ciglencečki and Modrijan (see Tonovcov grad. Settlement remains and interpretation, chapters 1.3, 2.1), thus we will merely focus on the presentation of the archeozoological analysis. Most of the faunal remains were manually gathered, for only a part of the excavated sediment was (dry) sifted through sieves.<sup>2</sup> Due to this the contribution of smaller bones, teeth and bone/tooth fragments is slightly underestimated (Tab. 8.19). Qualitative comparisons between the taxa are based on the number of identifiable specimens (NISP). In calculating NISP we joined the fragments that undoubtedly belong to the same bone (for example fragments of bones that were broken during the archaeological excavations), and counted them as a single example (i.e. NISP = 1). Within certain analyses we used the information as regards the minimum number of individuals (MNI) to complement the number of identifiable specimens.<sup>3</sup> In the examples in which a skeletal element appears in pairs we calculated the MNI for an individual element by taking into account the data from the numerically better represented anatomical side. All of the fragments of the same skeletal

<sup>2</sup> The sides of the square holes on the sieve measured 1 cm.

<sup>3</sup> For the discussion as regards the advantages and disadvantages of the individual indicators of abundance of finds see Gautier (1984), Grayson (1984), Grayson, Frey (2004).



menta sva v okviru nekaterih analiz metrične podatke standardizirala ter tako virtualno povečala razpoložljivi vzorec (cf. Albarella 2002). Standardiziranje sva izvedla v skladu s formulo:

$$\text{standardizirana vrednost} = (x - m) / s,$$

kjer  $x$  predstavlja dimenzijo primerka s Tonovcovega gradu,  $m$  in  $s$  pa povprečje in standardno deviacijo iste dimenzije pri referenčnem vzorcu. V okviru pričujočega prispevka sva kot referenčni vzorec uporabila gradivo iz rimskega mesta *Tác/Gorsium* (Madžarska; Bökönyi 1984), pri čemer sva upoštevala le skeletne elemente, zastopane z vsaj 30 primerki. Na ta način sva skušala zadovoljiti pogoju, da je za izračun povprečne vrednosti in standardne deviacije treba operirati z bolj ali manj normalno porazdeljenimi (metričnimi) podatki. Po drugi strani pa sva z izključitvijo pičlo zastopanih skeletnih elementov iz referenčnega vzorca zmanjšala (odpravila?) neželen vpliv<sup>4</sup> različnega deleža zastopanosti samcev, samic in kastratov med ostanki posameznih skeletnih elementov. Pričakujemo namreč lahko, da so med majhnimi vzorci razlike v deležu zastopanosti obeh spolov v splošnem večje kot med velikimi. To ne nazadnje potrjuje tudi podatek, da so razlike v deležu samcev, samic in kastratov med vzorcema govejih dlančnic ( $N = 168$ ) in stopalnic ( $N = 162$ ) iz rimskega mesta *Tác/Gorsium* praktično zanemarljive (Bökönyi 1984, Tab. 5), podobno pa velja tudi za favnistične vzorce s številnih drugih najdišč (npr. Riedel 1979, 99; 1993a, Tab. 6; 1994a, Tab. 3).

V primeru razlikovanja med tretjimi meljaki domačega prašiča (*Sus domesticus*) in njegovega divjega prednika (*S. scrofa*) sva uporabila zgornji sorodno metodo. Tu razmerje med posameznimi meritvami primerjamo z uporabo logaritma količnika med izbranimi metričnimi podatki v števcu in neko referenčno vrednostjo (tj. standardom) v imenovalcu (Payne, Bull 1988). V tem prispevku uporabljena standardna vrednost za širino tretjega zgornjega oz. spodnjega meljaka znaša 21,7 oz. 18,3 in temelji na vzorcu recentnih divjih prašičev (*Sus scrofa libycus*) iz Turčije (Payne, Bull 1988, 40 s).

<sup>4</sup> Predpostavimo, da želimo primerjati standardizirane metrične podatke za govedo z najdišč A in B ter da pri tem v postopku standardiziranja uporabimo referenčni vzorec, kjer med golenicami močno prevladujejo primerki samcev, med nadlahtnicami samic, pri ostalih skeletnih elementih pa je razmerje med spoloma približno enako. V kolikor bi med gradivom z najdišča A število izmerjenih golenic presegalo število nadlahtnic, v okviru najdišča B pa bi bilo obratno, potem bi zgoraj omenjene razlike v spolni strukturi med obema navedenima skeletnima elementoma v referenčnem vzorcu prispevale k višjim povprečnim vrednostim standardiziranih metričnih podatkov ( $\approx$  velikosti goved) za najdišče A nasproti najdišču B tudi v primeru, ko bi bila velikost govejih ostankov z obeh najdišč sicer primerljiva.

element from the opposite anatomical side for which it was ascertained that they undoubtedly belonged to other specimens (i.e. animals of a different age or the opposite sex) were added to this number.

Measurements were taken following the guidelines provided by von den Driesch (1976). Due to the often rather low numbers of measurable remains of individual skeletal elements the biometrical study has been performed on standardised metric data, which virtually increased the available sample (cf. Albarella 2002). The standardisation was performed in accordance to the following formula:

$$\text{Standardised value} = (x - m) / s,$$

in which  $x$  represents the dimension of the specimen from Tonovcov grad, while  $m$  and  $s$  represent the average and standard deviation of the same dimension from a reference sample. For this article we used the material from the Roman town of *Tác/Gorsium* (Hungary; Bökönyi 1984) as a reference sample, at which we took into account only skeletal elements represented by at least 30 specimens. In this way we tried to fulfil the condition that states that the average value and standard deviation needs to be calculated with more or less normally distributed (metric) data. Moreover, the exclusion of the poorly represented skeletal elements from the reference sample reduced (eliminated?) the undesired influence<sup>4</sup> of differential contributions of males, females and castrates to the remains of individual skeletal elements. Namely, we can expect that within small samples the inter-sample differences in the shares of the two sexes are generally greater than in large samples. This is also confirmed by the data that show that the differences in the contributions of males, females and castrates to the samples of bovine metacarpals ( $N = 168$ ) and metatarsals ( $N = 162$ ) from *Tác/Gorsium* are practically negligible (Bökönyi 1984, Tab. 5). Similar can be stated for the faunal assemblages from numerous other sites (e.g. Riedel 1979, 99; 1993a, Tab. 6; 1994a, Tab. 3).

In our attempt to differentiate between the third molars of domestic pig (*Sus domesticus*) and its wild ancestor (*S. scrofa*) we used a method similar to the

<sup>4</sup> Let's assume that we wish to compare the standardised measurements for cattle from sites A and B and that we in this standardisation process use a reference sample in which males dominate amongst the tibia remains, while females dominate with humerus remains; at the remaining skeletal elements the ratio between the sexes is roughly the same. In the event that the material from site A included a greater number of tibiae than humeri, and the picture would be the opposite in site B, then the above mentioned differences in the sex structure amongst the two skeletal elements within the reference sample would aid the higher average values of standardised measurements ( $\approx$  cattle size) for site A compared to site B even in the event that the size of bovine remains would be comparable at both sites.

Pri statistični obdelavi sva praviloma uporabljala neparametrične prijeme, saj vzorci pogosto niso izkazovali normalne porazdelitve. Med drugim sva proučevala tudi zastopanost posameznih anatomskih delov živalskega trupa (izraženo z NISP), ki sva jih na podlagi kakovosti in količine pripadajočega mesa razdelila v tri kategorije: kategorija A (vključuje ostanke nosačev, okretačev ter drugih vratnih, prsnih in križnih vretenc, lopatic, nadlahtnic, medenic in stegnenic), kategorija B (obsega ostanke lobanj, spodnjih čeljustnic, koželjnic, golenic in piščali) ter kategorija C (vključuje ostanke zgornjih čeljustnic, zob, dlančnic, stopalnic, zapestnih kosti, skočnic, petnic in ostalih nartnih kosti ter prstnic).

Podatke o deležu zastopanosti vsake od treh kvalitativnih kategorij ter tiste o številu določenih primerkov posameznega taksona sva v nadaljevanju uporabila kot vstopne podatke za analizo večdimenzionalnega skaliranja (*Multidimensional scaling*, MDS), da bi ugotovila obstoj morebitnih razlik v favnistični sliki v prostoru in času. Obstoj različnih pasem govedu sva proučevala z uporabo analize glavnih komponent (*Principal Component Analysis*, PCA), ki so bile izračunane na podlagi matrike treh merjenih dimenzij skočnic omenjenega taksona. Statistična obdelava je bila narejena s programskim paketom StatSoft 2001, Statistica za Windows, verzija 6.0.

Favnistično gradivo s Tonovcovega gradu hrani Tolminski muzej.

## 8.2 TAKSONOMIJA

Skupno je bilo med izkopavanji poznoantičnih in zgodnjemedievalnih plasti na Tonovcovem gradu pridobljenih 18.524 ostankov velikih sesalcev. Vsaj do nivoja rodu<sup>5</sup> jih je bilo mogoče določiti 5.621 (oz. 30,3 %). V razpoložljivem gradivu je zastopanih najmanj dvanajst vrst iz šestih družin (*tab. 8.1*), od katerih jih večino še danes najdemo na širšem območju Zgornje in Srednje Soške doline (Kryštufek 1991). Edino izjemo v tem smislu predstavlja globalno izumrlo pragovedo (*Bos primigenius*), čeprav je tudi današnja prisotnost kozoroga (Kryštufek 1991, 254) in morda divjega prašiča (Kryštufek 1991, 236) sicer le posledica ponovne naselitve po predhodnem lokalnem iztrebljenju.

Po številu določenih primerkov je najbolje zastopana vrsta v vzorcu najverjetneje ovca (*Ovis aries*). Z gotovostjo sva lahko slednji sicer pripisala zgolj 272 ostankov, kar predstavlja 63 odstotkov vseh specifično določenih kosti in zob drobnice.<sup>6</sup> Vendar pa lahko pričakujemo, da je s podobnim deležem ovca zastopana tudi v vzorcu vseh tistih ostankov poddružine Caprinae, ki jih do nivoja vrste sicer ni bilo mogoče določiti

<sup>5</sup> V primeru drobnice je bilo mogoče specifično določiti le 15,5 odstotka ostankov; ostali so določeni le do nivoja poddružine (tj. subfam. Caprinae).

<sup>6</sup> Kozi (*Capra hircus*) sva pripisala 156 ostankov.

one described above. In this case the ratio between the individual measurements was compared with the use of a logarithm that calculated the quotient between the selected metric data in the numerator and a referential value (i.e. standard) in the denominator (Payne, Bull 1988). In this contribution we used the standard value for the breadth of the upper or lower molar at 21.7 and 18.3, respectively. The two standards are based on the sample of recent wild boars (*Sus scrofa libycus*) from Turkey (Payne, Bull 1988, 40 f).

As a rule we used non-parametric approaches in our statistical analyses, for the samples often failed to show a normal distribution. In studying the representation of individual anatomical regions of the animal body (expressed in terms of NISP), we divided the various skeletal elements into three categories regarding the quality and quantity of meat: category A (includes remains of vertebrae, scapulae, humeri, pelvises and femora), category B (includes skull fragments, as well as fragments of lower jawbones, radii and tibiae) and category C (includes fragments of upper jawbones, teeth, metacarpals, metatarsals, carpals, tarsals and phalanges).

In the following we used the data on the contributions by each of the three qualitative categories and the abundance (NISP) of individual taxa as the input data used in *Multidimensional scaling* (MDS). This helped ascertaining the existence of the eventual differences in the exploited fauna through space and time. The existence of the various cattle forms/breeds was studied with the use of the *Principal Component Analysis* (PCA), which was calculated on the basis of the greatest length of the medial sides, greatest depth of the lateral side and the distal breadth of the astragalus. The statistical calculations were performed with StatSoft 2001 software, Statistica for Windows, version 6.0.

The faunal material from Tonovcov grad is kept by the Tolmin Museum.

## 8.2 TAXONOMY

During the excavations of the Late Antique and Early Medieval layers at Tonovcov grad a total of 18,524 large mammalian remains were discovered. Of these, 5,621 (30.3 %) could be defined at least to the level of the genus<sup>5</sup>. The material revealed a minimum of twelve species from six families (*Tab. 8.1*), most of which can still be found in the area of the Upper and Central Soča valley (Kryštufek 1991). The sole exception in this sense is represented by the globally extinct aurochs (*Bos primigenius*), even though today the Alpine ibex (Kryštufek 1991,

<sup>5</sup> In the event of sheep and goats only 15.5 percent of the remains could be identified to the level of species; the remaining finds could only be identified as belonging to the Caprinae subfamily.

Takson / Taxon	NISP	% NISP
Caprinae	2748	48,9
<i>Bos taurus</i>	1620	28,8
<i>Sus</i> sp.	1095	19,5
<i>Equus caballus</i>	67	1,2
<i>Cervus elaphus</i>	29 (19)	0,5
<i>Capra ibex</i>	14	0,2
<i>Capreolus capreolus</i>	9 (1)	0,2
<i>Bos</i> cf. <i>primigenius</i>	9	0,2
<i>Canis familiaris</i>	5	0,1
<i>Ursus arctos</i>	4	0,1
Ostalo / Rest	21	0,4
SKUPAJ / TOTAL	5621	100,0

(tj. 2.320 primerkov). Po tej oceni bi se število ostankov ovce v obravnavanem vzorcu povzpelo na približno 1.730, s čimer bi preseгло<sup>7</sup> število govedu (*Bos taurus*) pripisanih najdb (NISP = 1620). Slika je seveda povsem drugačna, če razmerje med obema vrstama izrazimo v količini z zakolom pridobljenega mesa; ne gre namreč pozabiti, da masa goved tudi za osemkrat presega maso ovac (Luff 1982, 8; Baker 1991, Tab. 76a).

Ovci in govedu po številu najdb sledita koza (*Capra hircus*) in domači prašič (*Sus domesticus*), katerih deleža zastopanosti sta bila ocenjena na slabih 20 odstotkov vseh določenih najdb. Natančnega števila kozjih ostankov, podobno kot v primeru ovac, ni mogoče podati. Enako velja za rod *Sus*, saj je zanesljivo razlikovanje med domačim in divjim prašičem (*Sus scrofa*) pogosto nemogoče. V primeru gradiva s Tonovcovega gradu sva delež zastopanosti vsake od obeh vrst prašičev ugotavljala s pomočjo podatkov o širini tretjih zgornjih in tretjih spodnjih meljakov; omenjeni dimenziji namreč izkazujejo le minimalno variabilnost v odvisnosti od starosti in spola živali (Payne, Bull 1988, 31). Rezultati nedvoumno dokazujejo prisotnost obeh vrst, v skladu s pričakovanji pa močno prevladujejo ostanki domačega prašiča (sl. 8.2). Skladni s tem so tudi podatki o dimenzijah kosti postkranialnega skeleta (pril. 8.1).

Od domačih živali so bile na Tonovcovem gradu najdene še kosti konja (*Equus caballus*) in psa<sup>8</sup> (*Canis familiaris*), ki pa skupaj predstavljajo le dober odstotek NISP. Podobno sliko kaže tudi večina sočasnih najdišč v

<sup>7</sup> Razlika v abundanci obeh taksonov sicer ostaja pod mejo statistične značilnosti ( $\chi^2$  test:  $p = 0,204$ ). Za podatke glede ostalih taksonov glej tab. 8.2.

<sup>8</sup> Kanidni okretaj iz vzorca št. 277 se po vrednosti širine kranialne sklepne površine (BFcr *sensu* von den Driesch 1976, 69) umešča tako znotraj variacijske širine za velike rimskodobne pse iz mesta Tăc/Gorsium (Bökönyi 1984, 212) kot tudi znotraj tiste za volkove (Riedel 1977, 167; lastni neobjavljeni podatki).

Tab. 8.1: Število določenih primerkov (NISP) za posamezne taksonne velikih sesalcev s Tonovcovega gradu. Skupina 'Ostalo' vključuje: *Bos taurus* s. *Equus caballus* (N = 5), *Bos taurus* s. *Cervus elaphus* (N = 2) ter Caprinae s. *Capreolus capreolus* (N = 14). Pri cervidih je v oklepaju podano število ostankov rogovja.

Tab. 8.1: Number of identifiable specimens (NISP) for individual large mammalian taxa at Tonovcov grad. The group "Other" includes: *Bos taurus* s. *Equus caballus* (N = 5), *Bos taurus* s. *Cervus elaphus* (N = 2) and Caprinae s. *Capreolus capreolus* (N = 14). For cervids the number of antler remains is provided in brackets.

254) and possibly the wild boar (Kryštufek 1991, 236) are present in this area only because they were reintroduced after having been made extinct.

According to the number of taxonomically identified remains it seems that sheep (*Ovis aries*) is the best represented species in the assemblage. Such a presumption is based on the expectation that the share of sheep in the assemblage of all Caprinae remains (N = 2748) should not differ considerably from what has been observed in studying the (only) 428 Caprinae remains identifiable to the level of species. Of these, 272 were referable to sheep (i.e. 63 %), the remaining 156 being those of goat (*Capra hircus*). According to this estimate the number of sheep remains in the studied assemblage would rise to approximately 1,730, with which it would surpass<sup>6</sup> the number of finds identifiable as cattle (*Bos taurus*, NISP = 1,620). Of course we get a completely different picture if the ratio between the two species is expressed with the amount of meat obtained through culling; one should not forget that the weight of cattle can surpass the weight of a sheep or goat by eight fold (Luff 1982, 8; Baker 1991, Tab. 76a).

In terms of the number of finds sheep and cattle are followed by goat and domestic pig (*Sus domesticus*), whose contributions were estimated at almost 20 percent of all the taxonomically identified mammal remains. Similarly to the case of sheep an exact number of goat remains cannot be provided.

The same holds true also for the two species of the genus *Sus*, for reliable differentiation between domestic pig and wild boar (*Sus scrofa*) is often impossible. In the case of the material from Tonovcov grad we assessed the contribution of both species by considering the breadth of the third upper and third lower molars, as the previously mentioned dimensions show merely a minimal variability in relation to the age and sex of the animal (Payne, Bull 1988, 31). While the results proved the presence of both *Sus* species, they emphasized the dominance of domestic pig (Fig. 8.2). The dimensions of the post-cranial skeletal elements also fit this pattern (Appendix 8.1).

<sup>6</sup> The difference in the abundance of both taxa remains below the level of statistical significance ( $\chi^2$  test:  $p = 0,204$ ). Data for other taxa are shown in table 8.2.

Tab. 8.2: Rezultati statističnega testiranja razlik v zastopanosti posameznih taksonov velikih sesalcev v vzorcu s Tonovcovega gradu z uporabo  $\chi^2$  testa. V tabeli so p-vrednosti običajnega  $\chi^2$  testa zapisane pokončno, p-vrednosti  $\chi^2$  testa z Yatesovimi popravki (*Yates corrected  $\chi^2$  test*; StatSoft, Inc. 2001) pa poševno. Statistično značilne razlike v zastopanosti posameznih taksonov (tj.  $p < 0,05$ ) so označene z zvezdo (\*). Legenda: Cap – Caprinae; B.T. – *Bos taurus*; E.C. – *Equus caballus*; C.E. – *Cervus elaphus*; C.I. – *Capra ibex*; C.C. – *Capreolus capreolus*; B.P. – *Bos primigenius*; C.F. – *canis familiaris*; U.A. – *Ursus arctos*.

Tab. 8.2: The results of the  $\chi^2$  statistical test of the differences in the representation of individual large mammalian taxa in the sample from Tonovcov grad. The table shows the p-values written in normal font, and the *Yates corrected* p-values (StatSoft, Inc. 2001) in italics. Statistically significant differences in the representation of the individual taxa (i.e.  $p < 0.05$ ) are denoted with an asterisk (\*). Abbreviations: Cap – Caprinae; B.T. – *Bos taurus*; E.C. – *Equus caballus*; C.E. – *Cervus elaphus*; C.I. – *Capra ibex*; C.C. – *Capreolus capreolus*; B.P. – *Bos primigenius*; C.F. – *canis familiaris*; U.A. – *Ursus arctos*.

	Cap.	B.T.	Sus	E.C.	C.E.	C.I.	C.C.	B.P.	C.F.	U.A.
Cap.		0,000*	0,000*	0,000*	0,000*	0,000*	0,000*	0,000*	0,000*	0,000*
B.T.	<i>0,000*</i>		0,000*	0,000*	0,000*	0,000*	0,000*	0,000*	0,000*	0,000*
Sus	<i>0,000*</i>	<i>0,000*</i>		0,000*	0,000*	0,000*	0,000*	0,000*	0,000*	0,000*
E.C.	<i>0,000*</i>	<i>0,000*</i>	<i>0,000*</i>		0,005*	0,000*	0,000*	0,000*	0,000*	0,000*
C.E.	<i>0,000*</i>	<i>0,000*</i>	<i>0,000*</i>	0,005*		0,124	0,017*	0,017*	0,000*	0,000*
C.I.	<i>0,000*</i>	<i>0,000*</i>	<i>0,000*</i>	<i>0,000*</i>	<i>0,127</i>		0,374	0,374	0,178	0,082
C.C.	<i>0,000*</i>	0,000*	0,000*	0,000*	0,018*	0,380		1,000	0,445	0,420
B.P.	<i>0,000*</i>	<i>0,000*</i>	<i>0,000*</i>	<i>0,000*</i>	<i>0,018*</i>	0,380	<i>1,000</i>		0,445	0,420
C.F.	<i>0,000*</i>	<i>0,000*</i>	<i>0,000*</i>	<i>0,000*</i>	<i>0,000*</i>	<i>0,184</i>	0,453	0,453		0,819
U.A.	<i>0,000*</i>	<i>0,000*</i>	<i>0,000*</i>	<i>0,000*</i>	<i>0,000*</i>	<i>0,087</i>	0,429	0,429	0,824	

regiji (Stork, von den Driesch 1987, Tab. 2; Baker 1991, 154; Pucher 1993, Tab. 1; Turk 2000, 169; Forstenpointner *et al.* 2002, Tab 1; Bartosiewicz, Choyke 1985, Tab. 1). Gre za pričakovano posledico dejstva, da konji in psi v pozni antiki pač niso bili (več) vir mesa za prehrano. Trupla poginulih živali so bila tako praviloma zavržena v odpadne jarke oz. jame (*cf.* Stallibrass 2000), zaradi česar se njihove kosti med "kuhinjskimi odpadki" pojavljajo le po naključju. Eno takšnih (odpadnih?) odlagališč je morda bilo ob vzhodnem vogalu objekta 1 (*sl.* 8.12). Na vsega skupaj 15 m<sup>2</sup> površine (tj. južna polovica kv. 669 in severna polovica kv. 719) je bilo namreč najdenih kar 19 konjskih ostankov (MNI = 3), kar predstavlja dve tretjini vseh kosti in zob omenjene vrste med gradivom iz druge poznoantične faze s Tonovcovega gradu. Pri tem je zanimivo, da je bila na istem mestu najdena tudi ena izmed skupno sicer le štirih kosti psa.

V okviru obravnave konjskih kosti si poseben komentar zasluži možnost, da je med njimi zastopana tudi mula. V to smer kaže morfologija prve prstnice iz vzorca št. 2110 (kv. 717; mkv. C3), ki je v skladu z opažanji Petersove (1998, sl. 56) bližje muli kot konju (*sl.* 8.3). Ne glede na utemeljenost takšne determinacije pa velja dodati, da mule na Tonovcovem gradu zagotovo niso bile številčne. Poleg primerka s *sl.* 8.3 je namreč ekvidno gradivo vključevalo še tri prve prstnice, ki pa so vse morfološko bližje konju. Enako velja tudi za ostanke še drugih skeletnih elementov,<sup>9</sup> katerih morfologija naj bi omogočala (vsaj pogojno) razlikovanje med obema oblikama (*sl.* 8.4).

<sup>9</sup> V okviru favniščenega vzorca s Tonovcovega gradu so to: distalni del koželjnice (N = 3), distalni del golence

Tonovcov grad also revealed bones of other domestic animals, such as horse (*Equus caballus*) and dog<sup>7</sup> (*Canis familiaris*); however they were discovered in small numbers as the two species together represent just above one percent of the NISP. A similar picture is shown also by other contemporaneous sites in the region (Stork, von den Driesch 1987, Tab. 2; Baker 1991, 154; Pucher 1993, Tab. 1; Turk 2000, 169; Forstenpointner *et al.* 2002, Tab 1; Bartosiewicz, Choyke 1985, Tab. 1). This is an expected consequence of the fact that in the studied region horse and dog meat was no longer considered to be a source of food in Late Antiquity.<sup>8</sup> Deceased animals were thus as a rule discarded and thrown into ditches or waste-holes (*cf.* Stallibrass 2000), which means that their bones appear amongst "kitchen waste" only by coincidence. One such (waste?) site might have existed at the east corner of building 1 (*Fig.* 8.12). As many as 19 horse finds (MNI=3) were located within a total of 15 m<sup>2</sup> (i.e. the south half of sq. 669 and the north half of sq. 719).<sup>9</sup> These finds represent two thirds of all horse bones and teeth within the material dated to the Late Antiquity phase 2. At this

<sup>7</sup> The breadth of the cranial articular surface (BFcr *sensu* von den Driesch 1976, 69) of the canine epistropheus from sample No. 277 corresponds to both large Roman period dogs from the town of TÁC/Gorsium (Bökönyi 1984, 212) and wolves (Riedel 1977, 167; own unpublished data).

<sup>8</sup> However, two horse bones from the Late Antiquity phase 2 did show cut-marks.

<sup>9</sup> The total excavation area within the area of structure 1 surpassed 400 m<sup>2</sup>.

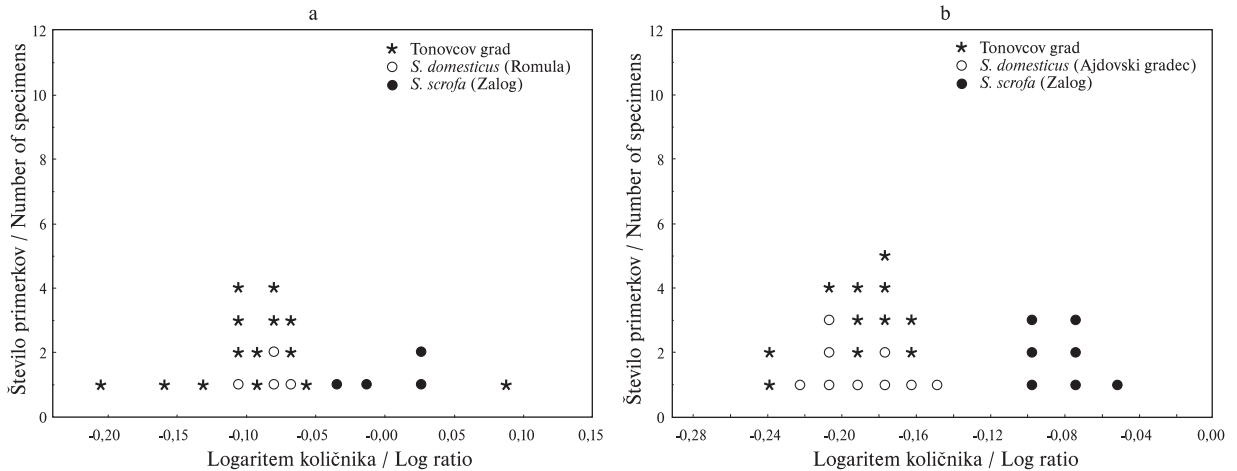

Sl. 8.2: Variabilnost v širini tretjega zgornjega (a) in tretjega spodnjega (b) meljaka pri prašičih s Tonovcovega gradu, domačih prašičih iz Ribnice/Romule (rimska doba; lastni neobjavljeni podatki) oz. z Ajdovskega gradca nad Vranjem (pozna antika; Bartosiewicz, Choyke 1985) ter divjih prašičih z Zaloga (mezolitik; Toškan, Dirjec 2006, 187). Variabilnost je izražena kot logaritem količnika med posamezno izmerjeno vrednostjo širine zoba in pa standardno vrednostjo za navedeno dimenzijo. Postopek izračunavanja logaritemskega količnika je podan v pogl. 8.1.

Fig. 8.2: The variability in the breadth of the third upper (a) and third lower (b) molar in pigs/wild boars from Tonovcov grad, pigs from Ribnica/Romula (Roman period; unpublished data) and Ajdovski gradec above Vranje (Late Antiquity; Bartosiewicz, Choyke 1985) and wild boars from Zalog (Mesolithic; Toškan, Dirjec 2006, 187). The variability is expressed as a logarithm of the quotient between the individual measured value of the tooth breadth and the standard value for the stated dimension. The procedure for calculating the logarithm quotient is given in chapter 8.1.

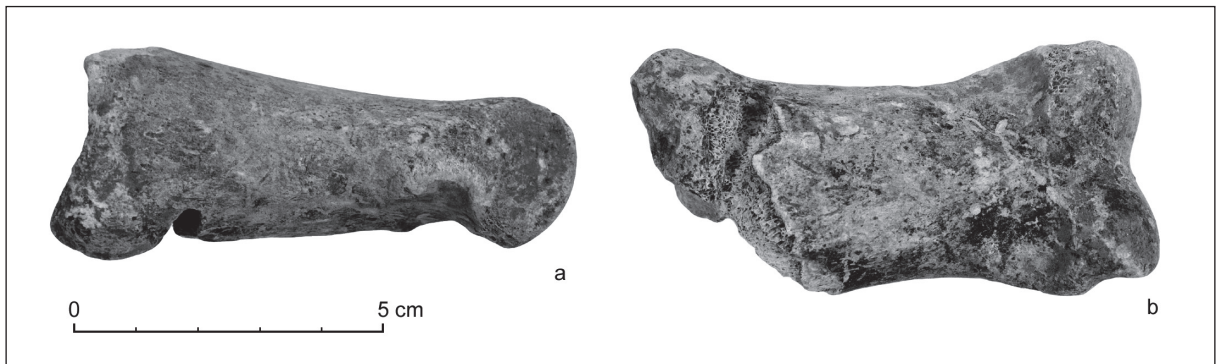

Sl. 8.3: Ekvidna prva prstnica s Tonovcovega gradu (št. vzorca: 2110; kv. 717; mkv. C3) z morfološkimi značilnostmi mule (cf. Peters 1998, Sl. 56). Foto: M. Zaplatil.

Fig. 8.3: The equid first phalanx from Tonovcov grad (sample No.: 2110; sq. 717; msq. C3) with morphological characteristics of a mule (cf. Peters 1998, Fig. 56). Photo: M. Zaplatil.

Delež kosti in zob lovnih živali med živalskimi ostanki s Tonovcovega gradu komaj presega odstotek NISP, čeprav je v gradivu sicer zastopanih najmanj<sup>10</sup> šest vrst divjadi. Ob zgoraj že omenjenem divjem prašiču so

(N = 2) ter dlančnica (N = 1); cf. Peters (1998, 411 ss).

<sup>10</sup> Upošteva je lego Tonovcovega gradu in ekološke zahteve nekaterih v favniškim vzorcu zastopanih lovnih vrst (npr. kozorog) ni mogoče z gotovostjo izključiti, da je med drobnici pripisanimi ostanki tudi kak primerek gamsa (*Rupicapra rupicapra*); zanesljivo razlikovanje med omenjeno vrsto na eni strani ter ovco oz. kozo na drugi je namreč razmeroma težavno (cf. Pucher, Engl 1997, 39 ss).

it might be interesting that one of the four (in total) dog bones was found at the same location.

While dealing with equid bones it should be mentioned that mules may be represented amongst them, too. This is indicated by the morphology of the first phalanx from sample No. 2110 (sq. 717; msq. C3), which is – according to the observations by Peters (1998, Fig. 56) – closer to a mule than a horse (Fig. 8.3). Regardless of the basis for such a speculation it should be added that mule remains were not to be found in larger quantities at Tonovcov grad. Namely, alongside the specimen from figure 8.3 the equid material included another three first

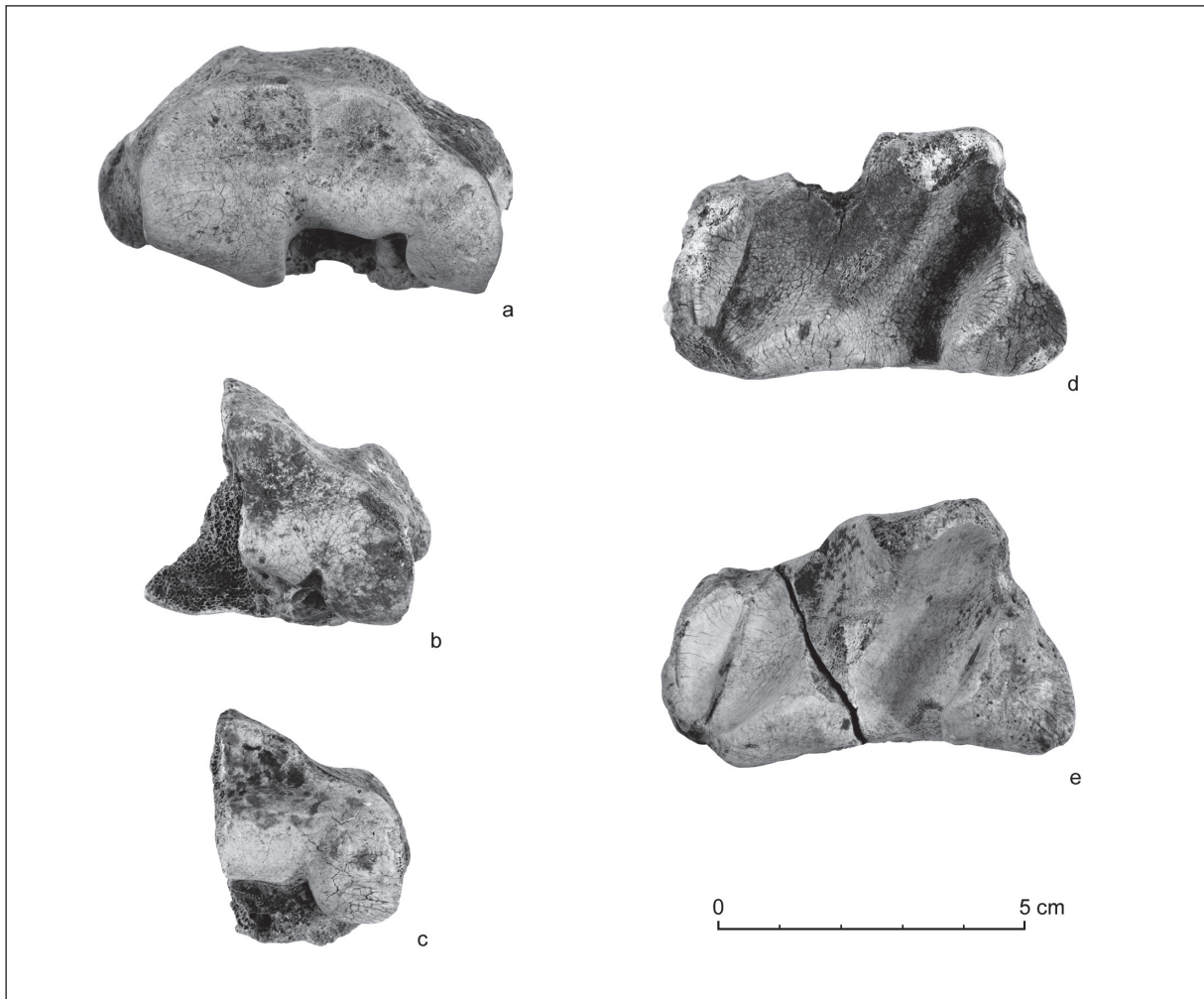

Sl. 8.4: Ekvidni ostanki s Tonovcovega gradu z morfološki značilnostmi konja (cf. Peters 1998, Sl. 54 in 55): **a** – distalni del koželjnice (št. vzorca 778); **b** – distalni del koželjnice (št. vzorca 960); **c** – distalni del koželjnice (št. vzorca 1711); **d** – distalni del golenice (št. vzorca 747); **e** – distalni del golenice (št. vzorca 1666). Foto: M. Zaplatil.

Fig. 8.4: Equid remains from Tonovcov grad with the morphological characteristics of a horse (cf. Peters 1998, Figs. 54 and 55): **a** – distal part of the radius (sample No. 778); **b** – distal part of the radius (sample No. 960); **c** – distal part of the radius (sample No. 1711); **d** – distal part of the tibia (sample No. 747); **e** – distal part of the tibia (sample No. 1666). Photo: M. Zaplatil.

to še jelen (*Cervus elaphus*), srna (*Capreolus capreolus*), kozorog (*Capra ibex*), rjavi medved (*Ursus arctos*) in pragovedo (*Bos primigenius*). Iz navedenega izhaja, da je lov v ekonomiji prebivalcev Tonovcovega gradu igral zelo obrobno vlogo. Ugotovitev je sicer pričakovana, saj podobno sliko kažejo praktično vsa arheozoološko obdelana poznoantična najdišča na območju med Gardskim jezerom v Italiji in Kozjanskim v vzhodni Sloveniji: Monte Barro (Baker 1991, 154), Torcello (faza Ta; Riedel 1979, 84 s), Verona (faza VR-I; Riedel 1994a, 77 ss), Videm/Udine (Riedel 1993b, Tab. 12), Sv. Pavel nad Vrtovinom (Svoljšak 1985, 226 s), Invillino (Stork, von den Driesch 1987, Tab. 2), Kappele (Pucher 1993, Tab. 1), Teriola (Pucher 2003, Tab. 1), Sv. Hema/Hemmaberg (Forstentner *et al.* 2001, Tab. 1), Ajdovski gradec nad Vranjem (Bartosiewicz, Choyke 1985) in Tinje (Turk 2000, 169).

phalanges, all of which were morphologically closer to horse. The same holds true for the remains of other skeletal elements<sup>10</sup> showing morphological characteristics which allow for the (at least conditional) discrimination between the two forms (Fig. 8.4).

The relative abundance of bones and teeth of wild animals hardly surpasses one percent of the total NISP, even though this share consists of at least<sup>11</sup> six species.

<sup>10</sup> The following were discovered in the faunal assemblage from from Tonovcov grad: the distal part of the radius (N = 3), the distal part of the tibia (N = 2) and metacarpus (N = 1); cf. Peters (1998, 411 ff).

<sup>11</sup> Taking into account the geographic position of Tonovcov grad and the ecological demands of some of the wild species (for instance ibex) represented within the fauna sample, it cannot be ruled out that the remains ascribed to sheep and goat might

Pravzaprav med navedenimi najdišči ni bistvenih razlik niti v samem naboru lovnih vrst. V tem smislu gre izpostaviti predvsem divjega prašiča, srno, medveda in jelena. Slednji je navadno zastopan predvsem z (obdelanimi) ostanki rogovja in tako je tudi v primeru Tonovcovega gradu.<sup>11</sup> Zdi se torej, da je bil lov<sup>12</sup> na jelene motiviran predvsem s pridobivanjem rogovij kot surovine za izdelavo raznih orodij. Drugače je bilo z divjim prašičem in srno, ki sta takratnim lovcem najverjetneje predstavljala predvsem dodaten vir mesa. Med skupno devetimi najdbami vrste *C. capreolus*<sup>13</sup> je tudi primerek v celoti ohranjenega rogovja, ki pa ne kaže sledi obdelave. Najdbe medveda so redke in morda predstavljajo ostanke živali, ki so bile uplenjene z namenom obrambe ljudi in živine (cf. Riedel 1989, 319) ali kot trofeja (cf. Johnstone 2007, 288).

Ostanki kozoroga v okviru poznoantičnih najdišč v regiji so izjemno redki.<sup>14</sup> Po najini najboljši vednosti je tak primer znan le z Gradišča nad Pivko pri Naklem (Rakovec 1973, 260). Gradivo s Tonovcovega gradu vključuje do deset kostnih fragmentov kozoroga. Njihova determinacija temelji na metričnih podatkih, ki pa spričo delnega prekrivanja dimenzij posameznih skeletnih elementov včasih ne dopuščajo zanesljivega razlikovanja med kozorogom in drobnico (sl. 8.5). Čeprav torej natančnega števila ostankov vrste *C. ibex* v gradivu s Tonovcovega gradu ni mogoče podati, pa o njihovi prisotnosti v obravnavanem vzorcu ne gre dvomiti. To poleg nekaterih ostankov, katerih dimenzije so prikazane na sliki 8.5, dokazujejo tudi metrični podatki petnice iz vzorca št. 110, nadlahtnice iz vzorca št. 1560, dveh fragmentov komolčnice iz vzorcev št. 1402 in 2090 ter morda tudi prva prstnica iz vzorca št. 1182 (pril. 8.1).

Posebno obravnavo zaslužijo bovidne najdbe, ki po svojih dimenzijah presegajo običajne vrednosti, ugotovljene pri domačem govedu (pozno)antične starosti v Srednji Evropi. V gradivu s Tonovcovega gradu je bilo takih najdb 14. Vsaj nekatere od njih se zdi utemeljeno pripisati pragovedu. Tak primer predstavlja fragment stegenice s slike 8.6, pri čemer velja dodati, da se proces zraščanja epifize sklepne glave (*caput femoris*) z diafizo pri tem primerku sploh še ni končal. Prav tako se zdi za domače govedo s poznoantičnega Tonovcovega gradu prevelik vsaj kateri od treh distalnih delov golenice s slike 8.7. Ti sicer ne odstopajo od največjih predstavnikov omenjene vrste iz rimskega mesta Tăc/Gorsium,<sup>15</sup> vendar

<sup>11</sup> Med skupno 29 najdbami jelena s Tonovcovega gradu je fragmentov rogovij kar 19, večina s sledmi obdelave.

<sup>12</sup> Do rogovij so sicer ljudje prihajali tudi s pobiranjem naravno odpadlih primerkov.

<sup>13</sup> Navedeno število najdb srne je morda nekoliko podcenjeno, saj sva 14 kostnih fragmentov determinirala le kot *Capreolus capreolus* s. Caprinae.

<sup>14</sup> Podobno sliko kažejo praktično vsa holocenska najdišča v SV Italiji (Riedel 1989, 317) in na Slovenskem (Rakovec 1973, 257 ss).

<sup>15</sup> Opisna statistika za dimenzijo 'najmanjša širina diafize golenice' z najdišča Tăc/Gorsium (N = 51): razpon vredno-

Alongside wild boar, remains of the red deer (*Cervus elaphus*), roe deer (*Capreolus capreolus*), Alpine ibex (*Capra ibex*), brown bear (*Ursus arctos*) and aurochs (*Bos primigenius*) can also be found in the studied assemblage. From the modest contribution of wild animals it is clear that hunting played a quantitatively insignificant role in the economy of the inhabitants of Tonovcov grad. This was to be expected, for a similar picture was portrayed by practically all archeozoologically analyzed Late Antique sites in the area between Lake Garda in Italy and Kozjansko in East Slovenia: Monte Barro (Baker 1991, 154), Torcello (phase Ta; Riedel 1979, 84 f), Verona (complex VR-I; Riedel 1994a, 77 ff), Udine (Riedel 1993b, Tab. 12), Sv. Pavel above Vrtovin (Svoljšak 1985, 226 f), Invillino (Stork, von den Driesch 1987, Tab. 2), Kappel (Pucher 1993, Tab. 1), Teriola (Pucher 2003, Tab. 1), Hemmaberg (Forstenpointner *et al.* 2001, Tab. 1), Ajdovski gradec above Vranje (Bartosiewicz, Choyke 1985) and Tinje (Turk 2000, 169). No great inter-site differences were observed in the wild species composition either. Red deer is usually well represented with remains of (worked) antler, which is also the case at Tonovcov grad.<sup>12</sup> It therefore seems that the main goal of red deer stalking<sup>13</sup> was obtaining antlers, later used as a raw material in producing tools. The situation was different with wild boar and roe deer, which most likely represented an additional meat source for the hunters. Amongst the total of nine finds of the species *C. capreolus*<sup>14</sup> a set of fully preserved antlers was also discovered; however this particular set did not show any traces of working. Bear finds are rare and possibly represent remains of animals that were killed in order to protect people and domestic animals (cf. Riedel 1989, 319) or in order to procure trophies (cf. Johnstone 2007, 288).

Alpine ibex remains are extremely rare at Late Antique sites in the region.<sup>15</sup> To our best knowledge such an example is known only from the hilltop settlement Gradišče nad Pivko near Naklo (Rakovec 1973, 260). The material from Tonovcov grad includes up to ten bone fragments that belonged to the Alpine ibex. Their taxonomic identification is based on metric data, which – however – does occasionally not allow for a reliable differentiation between the alpine ibex and sheep or goat (Fig. 8.5). Even though it is impossible to

also include chamois (*Rupicapra rupicapra*), for it is often impossible to clearly differentiate between the chamois on one side and sheep or goat on the other (cf. Pucher, Engl 1997, 39 ff).

<sup>12</sup> From the total of 29 red deer finds from Tonovcov grad 19 are antler fragments, most of which show traces of working.

<sup>13</sup> Antlers were also obtained just by picking up specimens that were shed naturally.

<sup>14</sup> The number of roe deer finds could be slightly underestimated, for we have defined 14 bone fragments merely as *Capreolus capreolus* s. Caprinae.

<sup>15</sup> Practically all Holocene sites in NE Italy (Riedel 1989, 317) and the territory of present day Slovenia (Rakovec 1973, 257 ff) show a similar trend.

Sl. 8.5: Dimenzije dolgih kosti kozoroga s Tonovcovega gradu (●). Za primerjavo so podane meritve fosilnih kozorogov iz več francoskih najdišč (○; Prat 1966, 289 s) ter drobnice s Tonovcovega gradu (diagram tipa okvirji z ročaji). Velikosti vzorcev drobnice za posamezno dimenzijo so sledeče: Hum (Bd): 21; Rad (Bp): 24; Rad (SD): 9; Mc (Bp): 8. Legenda: Hum – nadlaktica; Rad – koželjnica; Mc – dlančnica. Dimenzije so povzete po von den Drieschevi (1976) in so predstavljene v prilogi 8.1. Fig. 8.5: Dimensions of ibex long bones from Tonovcov grad (●). As a comparison we have given the measurements of fossil ibex from a number of French sites (○; Prat 1966, 289 s) as well as sheep and goat from Tonovcov grad (Box & whisker diagram). The sample size of the sheep and goats for a specific dimension is as follows: Hum (Bd): 21; Rad (Bp): 24; Rad (SD): 9; Mc (Bp): 8. Legend: Hum – humerus; Rad – radius; Mc – metacarpal. The dimensions are taken from von den Drieschevi (1976). See Appendix 8.1.

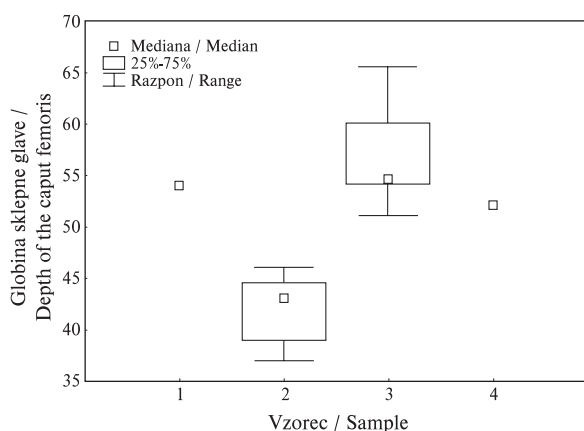

Sl. 8.6: Največja globina sklepne glavice stegenice (DC *sensu* von den Driesch 1976) s Tonovcovega gradu (vzorec št. 2084, kv. 766, mkv. D2). Podani so tudi primerjalni podatki za domače govedo, pragovedo in zobra. Seznam in velikost (N) vzorcev: 1 – *Bos primigenius* s. *Bison bonasus*, Tonovcov grad (4.–5. stoletje; N = 1); 2 – *Bos taurus*, Tonovcov grad (4.–8. stoletje; N = 12); 3 – *Bos primigenius*, več evropskih najdišč (holocen; N = 14; Boessneck *et al.* 1963, 185 s; Chaix, Arbogast 1999, 48); 4 – *Bison bonasus*, Seeberg (Švica, neolitik; N = 1; Boessneck *et al.* 1963, 185). Vse mere so v mm.

Fig. 8.6: The greatest depth of the *caput femoris* (DC *sensu* von den Driesch 1976) from Tonovcov grad (sample No. 2084, sq. 766, msq. D2). Given are also the comparative data for domestic cattle, aurochs and European bison. List and size (N) of samples: 1 – *Bos primigenius* s. *Bison bonasus*, Tonovcov grad (4<sup>th</sup>–5<sup>th</sup> century; N = 1); 2 – *Bos taurus*, Tonovcov grad (4<sup>th</sup>–8<sup>th</sup> century; N = 12); 3 – *Bos primigenius*, a number of European sites (Holocene; N = 14; Boessneck *et al.* 1963, 185 f; Chaix, Arbogast 1999, 48); 4 – *Bison bonasus*, Seeberg (Switzerland, Neolithic; N = 1; Boessneck *et al.* 1963, 185). All measurements are in mm.

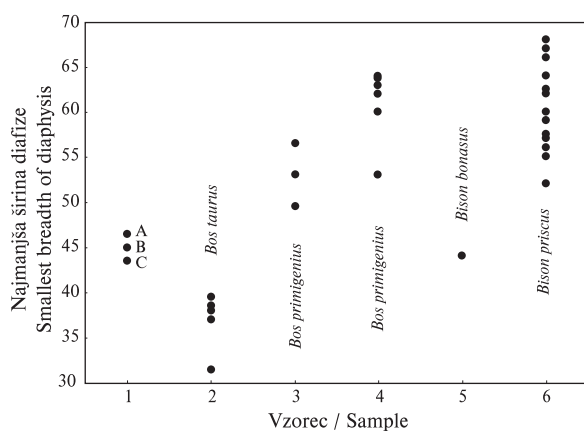
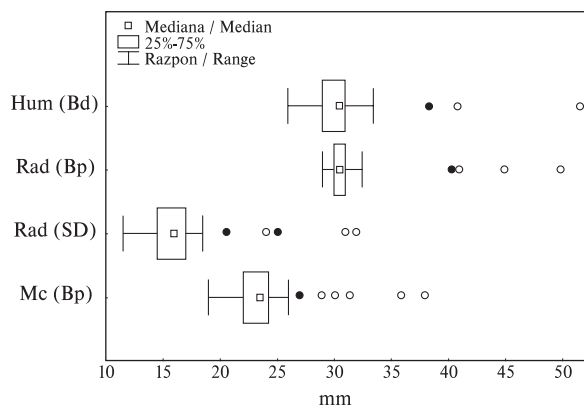

Sl. 8.7: Najmanjša širina diafize (Bd *sensu* von den Driesch 1976) treh bovidnih golenic s Tonovcovega gradu (primerek A: vzorec št. 1335, kv. 769, mkv. A2; primerek B: vzorec št. 519, kv. 631, mkv. C4; primerek C: vzorec št. 279, kv. 769, mkv. A4). Podani so tudi primerjalni podatki za domače govedo, pragovedo, zobra in stepskega bizona. Seznam vzorcev: 1 – *Bos* s. *Bison*, Tonovcov grad (4.–7. stoletje); 2 – *Bos taurus*, Tonovcov grad (4.–7. stoletje); 3 – *Bos primigenius*, zahodna Evropa (holocen; Chaix, Arbogast 1999, 48); 4 – *Bos primigenius*, srednja Evropa (mlajši pleistocen; Martin 1987, 119); 5 – *Bison bonasus*, Seeberg (Švica, neolitik; Boessneck *et al.* 1963, 186 s); 6 – *Bison priscus*, Cava Filo (Italija, mlajši pleistocen; Sala 1986, 148). Vse mere so v mm.

Fig. 8.7: The smallest breadth of diaphysis (Bd *sensu* von den Driesch 1976) from the three bovine tibia at Tonovcov grad (specimen A: sample No. 1335, sq. 769, msq. A2; specimen B: sample No. 519, sq. 631, msq. C4; specimen C: sample No. 279, sq. 769, msq. A4). Provided is also the comparative data for domestic cattle, aurochs, European bison and steppe bison. List of samples: 1 – *Bos* s. *Bison*, Tonovcov grad (4<sup>th</sup>–7<sup>th</sup> century); 2 – *Bos taurus*, Tonovcov grad (4<sup>th</sup>–7<sup>th</sup> century); 3 – *Bos primigenius*, western Europe (Holocene; Chaix, Arbogast 1999, 48); 4 – *Bos primigenius*, Central Europe (early Pleistocene; Martin 1987, 119); 5 – *Bison bonasus*, Seeberg (Switzerland, Neolithic; Boessneck *et al.* 1963, 186 f); 6 – *Bison priscus*, Cava Filo (Italy, early Pleistocene; Sala 1986, 148). All measurements are given in mm.



pa pri tem ne gre pozabiti, da se je na območju jugovzhodnih Alp velikost goved v pozni antiki zmanjšala (Riedel 1994b, 54). V zvezi s sliko 8.7 velja opozoriti tudi na to, da je fosilno pragovedo v povprečju presehalo velikost subfosilnega in da podobno velja tudi za ledenodobnega stepskega bizona (*Bison priscus*) nasproti recentnemu zobru (*B. bonasus*). Še zadnja bovidna najdba, ki je po svojih dimenzijah nedvomno bliže pragovedu kot domačemu govedu, je tretja prstnica iz vzorca št. 54 (kv. 666; mkv. D1). Diagonalna dolžina ventralnega dela<sup>16</sup> namreč pri omenjenem primerku meri 83,0 mm, medtem ko je razpon vrednosti za navedeno dimenzijo pri domačemu govedu s Tonovcovega gradu od 52,5 do 78,0 mm (N = 11), pri pragovedu/zobru s švicarskega mlajšekamenodobnega kolišča Seeberg pa med 73,0 in 93,0 mm (N = 78; Boessneck *et al.* 1963, 196).

Resnici na ljubo zgolj na podlagi dimenzij in morfoloških značilnosti zgoraj navedenih bovidnih najdb ni mogoče z gotovostjo zavrniti možnosti, da je med njimi zastopan tudi zober. Razlog, da se to vendarle ne zdi zelo verjetno, je odsotnost najdb omenjene vrste na Slovenskem in v Italiji v obdobju antike in srednjega veka (Rakovec 1973; Bon *et al.* 1991; Benecke 2005–2006, 426). Po drugi strani pa velja omeniti tudi poročilo langobardskega zgodovinarja Pavla Diakona, da so zobri živeli v pragozdovih med Vipavsko in Zgornjesavsko dolino še tudi takrat, ko se je langobardski kralj Alboin s svojo vojsko in prebivalstvom leta 568 selil čez današnjo Slovenijo v Italijo.<sup>17</sup>

Težave s kriteriji za razlikovanje med pragovedom in zobrom so manj moteče v primeru preostalih devetih od predhodno omenjenih 14 nadpovprečno velikih bovidnih kosti s Tonovcovega gradu. Ne le zato, ker nekatere od njih odstopajo od morfologije zobra (*cf.* Sala 1986; Martin 1987), temveč tudi zato, ker se po svojih dimenzijah prav vse umeščajo bliže domačemu govedu kot kateri od obeh divjih vrst. Slednje je morda še najmanj očitno v primeru fragmenta lopatice s slike 8.8, saj je prekrivanje med metričnimi podatki domačega goveda in pragoveda tu precejšnje. Bistveno manj problematična se zdi determinacija za domače govedo v primeru najdb, prikazanih v tabeli 8.3. Navedene kosti so bile najdene v istem kvadrantu (celo v istem mikrokvadrantu) in so tako verjetno pripadale istemu, za takratne razmere relativno velikemu domačemu govedu. Ta je po velikosti presegal celo dimenzije mlajšekamenodobnih primerkov s švicarskega najdišča Seeberg, čeprav je takratno domače govedo po velikosti zaostajalo le za velikim rimskodobnim in je torej prekašalo poznoantične oz. zgodnjerednjeveške primerke (Guinard 1999, 14 s).

sti = 28,5–47,0 mm; povprečna vrednost 38,3 mm; standardna deviacija = 4,74.

<sup>16</sup> DLS *sensu* von den Driesch 1976.

<sup>17</sup> *cf.* Pavel Diakon (Paulus Diaconus): *Zgodovina Langobardov (Historia Langobardorum)*, (prevedli: F. Bradač, B. Grafenauer in K. Gantar), Maribor, 1988, 66.

provide a precise number of *C. ibex* remains within the material from Tonovcov grad, its presence is not to be doubted. Alongside certain remains – the dimensions of which are shown in figure 8.5 – this is also proven by the measurements of the calcaneus of sample No. 110, the humerus from sample No. 1560, two ulna fragments from samples Nos. 1402 and 2090 and possibly also the first phalanx from sample No. 1182 (*Appendix 8.1*).

Bovine finds – whose sizes exceed the usual values ascertained for (Late) Antique domestic cattle in Central Europe deserve special attention. The material from Tonovcov grad included 14 such specimens. It seems that at least some of them can be ascribed to the aurochs. One such specimen is represented by the femur fragment shown on figure 8.6, displaying an unfused *caput femoris*. At least one of the three tibia distal epiphyses from figure 8.7 seems to surpass in size the Late Antique domestic cattle from Tonovcov grad, too. It is true that all three specimens correspond to the largest representatives of cattle from the Roman town of Tăc/Gorsium,<sup>16</sup> however it is noteworthy that the size of cattle in the southeast Alpine area became smaller in Late Antiquity (Riedel 1994b, 54).

The last bovine find definitely closer to aurochs than domestic cattle, is the third phalanx from sample No. 54 (sq. 666; msq. D1). Its diagonal length on the ventral part<sup>17</sup> measures 83.0 mm, with the range of the same dimension observed in domestic cattle from Tonovcov grad (N = 11) and in aurochs/European bison from the Swiss Neolithic pile-dwelling site at Seeberg (N = 78; Boessneck *et al.* 1963, 196) being 52.5–78.0 mm and 73.0–93.0 mm, respectively.

Based on the dimensions and morphological characteristics of five of the aforementioned 14 large bovine finds, the possibility of some of them belonging to the European bison cannot be rejected. After all the Lombardian historian Pavel Diakon reported that the species was present in the forests between the Vipava and Upper Sava valleys even in 568, when the Lombardian king Alboin together with his army and citizens were moving across the territory of present-day Slovenia into Italy (Paulus Diaconus, *Historia Langobardorum* 2, 8).<sup>18</sup> Nevertheless, in view of the lack of Antique and medieval finds of the European bison in Slovenia and NE Italy (Rakovec 1973; Bon *et al.* 1991; Benecke 2005–2006, 426), the possibility of these bones belonging to aurochs seems to be much more likely.

The problems with the criteria for differentiating between *Bos primigenius* and *Bison bonasus* are not

<sup>16</sup> The descriptive statistics for 'the smallest breadth of the tibia diaphysis' from the site Tăc/Gorsium (N = 51): range = 28.5–47.0 mm; average = 38.3 mm; standard deviation = 4.74.

<sup>17</sup> DLS *sensu* von den Driesch (1976).

<sup>18</sup> *cf.* Pavel Diakon (Paulus Diaconus): *Zgodovina Langobardov (Historia Langobardorum)*, (slovenian translation by: Bradač, F. Grafenauer, B. and Gantar, K.), Maribor, 1988, 66.

Tab. 8.3: Dimenzije bovidnih kosti iz vzorca št. 2006 (kv. 719, mkv. D1) s Tonovcovega gradu, ki so domnevno pripadale isti živali. Podani so tudi primerjalni podatki za domače govedo s Tonovcovega gradu, Ajdovskega gradca (Slovenija; Bartosiewicz, Choyke 1985) in Seeberga (Švica; Boessneck *et al.* 1963, 176 ss) ter pragovedo iz več evropskih najdišč (Boessneck *et al.* 1963, 176 ss; Bökönyi 1984, 150; Chaix, Arbogast 1999, 47 s). Legenda: Me – mediana; N – velikost vzorca; Min.–Max. – razpon vrednosti. Dimenzije so povzete po von den Drieschevi (1976) in so predstavljene v prilogi 8.1. Za časovno umestitev najdišč glej besedilo. Vse mere so izražene v mm.

Tab. 8.3: The dimensions of the bovine bones from sample No. 2006 (sq. 719, msq. D1) from Tonovcov grad, assumed to belong to the same animal. Provided is also comparative data for cattle from Tonovcov grad, Ajdovski gradec (Slovenia; Bartosiewicz, Choyke 1985) and Seeberg (Switzerland; Boessneck *et al.* 1963, 176 ff) as well as for aurochs from numerous European sites (Boessneck *et al.* 1963, 176 ff; Bökönyi 1984, 150; Chaix, Arbogast 1999, 47 f). Abbreviations: Me – median; N – sample size; Min.–Max. – range. The dimensions are taken from von den Driesche (1976). For the placement of sites in time see text. All measurements are given in mm.

Dimenzija Dimension		<i>Bos cf. taurus</i>	<i>Bos taurus</i>			<i>B. primigenius</i>
		Tonovcov grad	Tonovcov grad	Ajdovski gradec	Seeberg	Evropa / Europe
		Mera Measurement	Me (N) Min.–Max.	Me (N) Min.–Max.	Me (N) Min.–Max.	Me (N) Min.–Max.
Humerus	Bp	88,0	–	–	79,0 (3) 73,0–86,0	140,0 (5) 136,0–146,0
Ulna	DPA	67,0	63,0 (1)	–	58,5 (6) 56,0–61,0	83,0 (5) 79,0–97,0
Femur	DC	45,0	42,75 (12) 37,0–46,0	–	40,0 (1)	54,5 (14) 51,0–65,5
Tibia	Dd	42,5	41,5 (13) 37,5–46,0	45,8 (5) 40,5–52,4	–	54,25 (18) 44,0–63,5
Phalanx 2	GL	44,0	37,5 (37) 26,0–43,5	–	37,0 (5) 35,0–38,5	48,0 (52) 42,0–53,0

Sl. 8.8: Največja širina sklepne jamice (BG *sensu* von den Driesch 1976) bovidne lopatice s Tonovcovega gradu (vzorec št. 1662, kv. 668, mkv. C2). Podani so tudi primerjalni podatki za domače govedo, pragovedo in zobra. Seznam in velikost (N) vzorcev: 1 – *Bos primigenius* s. *Bison bonasus*, Tonovcov grad (4.–7. stoletje; N = 1); 2 – *Bos taurus*, Tonovcov grad (4.–8. stoletje; N = 12); 3 – *Bos primigenius*, Seeberg (Švica, neolitik; N = 15; Boessneck *et al.* 1963, 176 s); 4 – *Bison bonasus*, Seeberg (Švica, neolitik; N = 6; Boessneck *et al.* 1963, 176 s). Vse mere so v mm.

Fig. 8.8: Breadth of the glenoid cavity (BG *sensu* von den Driesch 1976) of the bovine scapula from Tonovcov grad (sample No. 1662, sq. 668, msq. C2). Provided is also comparative data for domestic cattle, aurochs and European bison. The list and sizes (N) of samples: 1 – *Bos primigenius* s. *Bison bonasus*, Tonovcov grad (4<sup>th</sup>–7<sup>th</sup> century; N = 1); 2 – *Bos taurus*, Tonovcov grad (4<sup>th</sup>–8<sup>th</sup> century; N = 12); 3 – *Bos primigenius*, Seeberg (Switzerland, Neolithic; N = 15; Boessneck *et al.* 1963, 176 f); 4 – *Bison bonasus*, Seeberg (Switzerland, Neolithic; N = 6; Boessneck *et al.* 1963, 176 f). All measurements are given in mm.

K domačemu govedu sva na podlagi metričnih podatkov pripisala tudi fragment komolčnice iz vzorca št. 519, katerega globina na mestu komolčnega odrastka<sup>18</sup> meri 67,0 mm (primerjaj tudi s tab. 8.3), ter drobce distalne golenice iz vzorca št. 1825. Slednji sicer

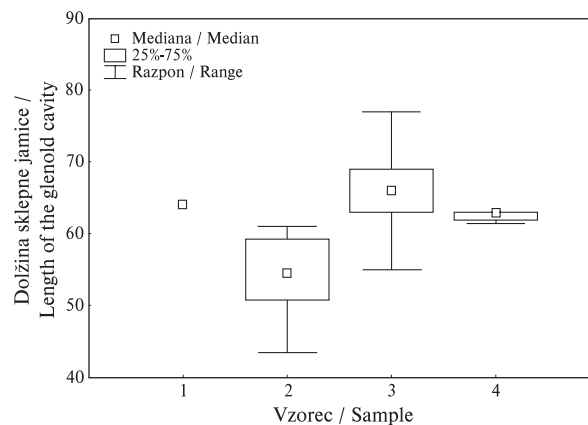

as great with the remaining nine large bovine bones studied from Tonovcov grad. This is the case not only because some of them differ from the morphology of the European bison (*cf.* Sala 1986; Martin 1987), but also because all of them are closer in their dimensions to cattle than to either of the wild species. The latter is not so obvious in the case of the scapula fragment shown in figure 8.8, for the measurements of cattle and those of aurochs are rather similar in this case. Ascribing the specimens referred to as *B. taurus* in table 8.3 seems less problematic. These bones were found in the same square (even micro-square) and thus most likely belong to the

<sup>18</sup> DPA *sensu* von den Driesch 1976.

nekoliko izstopa zaradi razmeroma globoke distalne epifize<sup>19</sup> (tj. 46,5 mm; primerjaj tudi s *tab.* 8.3), ki dosega spodnji rob razpona vrednosti za pragovedo. Ker pa meri najmanjša širina diafize omenjene golenice zgolj 38 mm (primerjaj tudi s *sl.* 8.7), sva jo vendarle pogojno determinirala za domače govedo.

### 8.3 PORAZDELITEV NAJDB V ČASU

Na Tonovcovem gradu sta bili ugotovljeni dve fazi poznoantične poselitve in ena zgodnjerednjeveška (za časovno opredelitev posamezne faze glej op. 1). Največ najdb (tj. 39,3 %) izvira iz druge poznoantične faze, medtem ko jih gre z zgodnjerednjeveško poselitvijo – ta je bila sicer bistveno manjša od obeh poznoantičnih (glej Tonovcov grad. Naselbinski ostanki in interpretacija, pogl. 2.2.) – povezati komaj 7,7 odstotka. Primerjava deležev zastopanosti posameznih taksonov je pokazala na veliko podobnost med gradivoma iz druge poznoantične ter iz zgodnjerednjeveške faze, medtem ko vzorec iz prve poznoantične faze odstopa po očitno večjem deležu zastopanosti domačega goveda (*tab.* 8.4). Relativna frekvenca pojavljanja lovnih vrst je v vseh treh primerih zanemarljiva (vrti se okrog odstotka NISP), nobenih omembe vrednih medfaznih razlik pa ni opaziti niti v pogledu vrstne pestrosti (*sl.* 8.13).

Del kosti in zob s Tonovcovega gradu ni bilo mogoče z zanesljivostjo pripisati nobeni od treh faz, čeprav gre zagotovo za gradivo iz obdobja med koncem 4. in 8. (morda 9.) stoletjem. Je pa bilo na podlagi arheoloških podatkov dobro polovico od navedenih ostankov mogoče umestiti v drugo poznoantično fazo vsaj z zelo veliko verjetnostjo (*tab.* 8.5), saj je bila mednje v okviru posamezne stratigrafske enote domnevno pomešana le peščica zgodnjerednjeveških kosti in zob. Takšno tezo na neki način potrjuje tudi izrazita pozitivna korelacija v deležu zastopanosti posameznih taksonov med navedenim vzorcem in gradivom, katerega umestitev v drugo poznoantično fazo ni vprašljiva (Pearsonov koeficient korelacije: 0,996;  $p = 0,000$ ). Posledično sva tako v okviru nadaljnjih analiz gradivu iz druge poznoantične faze prištela tudi vse tiste kosti in zobe iz premešanih plasti, katerih datiranje v omenjeno fazo sicer ni povsem zanesljivo, je pa zelo verjetno (glej *tab.* 8.5). Takšno postopanje nama je omogočilo operirati z večjimi vzorci, kar je prispevalo k boljši reprezentativnosti rezultatov. Pri tem naj domnevna prisotnost posameznih najdb iz zgodnjerednjeveške faze ne bi bila moteča, saj je njihovo število v združenem vzorcu zanemarljivo.

V okviru tukaj predstavljene študije sesalske makrofavne s Tonovcovega gradu je abundanca posameznih taksonov in/ali (skupin) skeletnih elementov praviloma izražena s podatkom o najmanjšem številu določenih primerkov (NISP). Pri medfazni primerjavi deležev zasto-

same cattle, relatively large for the time. The size of this animal must have exceeded the specimens of Neolithic age from the Swiss site of Seeberg, even though the cattle of the time lagged in size only behind the large Roman period forms and was thus larger than the Late Antique and Early Medieval ones (Guintard 1999, 14 f).

On the basis of its size (i.e. the depth across the *processus anconaeus*<sup>19</sup> equals 67.0 mm; *Tab.* 8.3) the ulna fragment from sample No. 519 is referable to cattle as was the fragment of the distal tibia from sample No. 1825. The latter stands out slightly due to the relatively deep distal epiphysis<sup>20</sup> (46.5 mm; *Tab.* 8.3) that is as deep as has been observed in small aurochs. Nevertheless, as the smallest breadth of the distal end measures a mere 38.0 mm (*Fig.* 8.7) we have opted for its conditional identification as cattle.

### 8.3 DIACHRONIC DISTRIBUTION OF FINDS

Two Late Antiquity and an Early Medieval settlement phases (for the dating of each phase see Note 1) were established at Tonovcov grad. Most finds originate from Late Antiquity phase 2 (i.e. 39.3 %), while a mere 7.7 % date to the Early Medieval phase, when the settlement was, however, much less intensive (see Tonovcov grad. Settlement remains and interpretation, chapter 2.2). The comparison between the contributions of individual taxa showed great similarity between Late Antiquity phase 2 and the Early Medieval phase, while the assemblage from the Late Antiquity phase 1 differs by its obviously greater share of cattle (*Tab.* 8.4). As they represent roughly 1 per cent of NISP the hunted species are negligible in all three samples, and no significant differences between the individual phases were observed as far as species richness is concerned (*Fig.* 8.13).

Some bones and teeth from Tonovcov grad could not be reliably attributed to any of the three settlement phases, although they certainly originate from the period encompassed between the end of the 4<sup>th</sup> and the 8<sup>th</sup> (maybe even 9<sup>th</sup>) century. Nevertheless, on the basis of the archaeological data the majority of these remains could be placed into Late Antiquity phase 2 with a high degree of probability (*Tab.* 8.5), for within each stratigraphic unit only a handful of early medieval finds were mixed amongst Late Antique material. This is further confirmed by the strong positive correlation in the shares of individual taxa observed in the aforementioned assemblage and the material that reliably belongs to Late Antiquity phase 2 (Pearson correlation coefficient:  $r = 0.996$ ,  $p = 0.000$ ). Consequently, all bones and teeth from the mixed layers that cannot be reliably dated to the aforementioned phase, but are highly likely to belong

<sup>19</sup> DPA *sensu* von den Driesch (1976).

<sup>20</sup> Dd *sensu* von den Driesch (1976).

<sup>19</sup> Dd *sensu* von den Driesch 1976.

Tab. 8.4: Število določenih primerkov (NISP) za posamezne taksone velikih sesalcev s Tonovcovega gradu po fazah. Skupina 'Ostalo' vključuje: *Bos taurus* s. *Equus caballus*, *Bos taurus* s. *Cervus elaphus* ter Caprinae s. *Capreolus capreolus*. Pri cervidih je v oklepaju podano število ostankov rogovja. Legenda: PA – poznoantična faza; ZSV – zgodnjemedievalna faza.

Tab. 8.4: Number of identifiable specimens (NISP) for individual large mammalian taxa from Tonovcov grad per individual phase. The group "Other" includes: *Bos taurus* s. *Equus caballus*, *Bos taurus* s. *Cervus elaphus* and Caprinae s. *Capreolus capreolus*. For cervids the number of antler remains is provided in brackets. Legend: LA – Late Antiquity phase; EMA – Early Medieval phase.

Takson Taxon	PA 1 / LA 1		PA 2 / LA 2		ZSV / EMA		Mešano / Mixed	
	NISP	%	NISP	%	NISP	%	NISP	%
Caprinae	638	40,4	1124	52,4	230	58,7	756	50,4
<i>Bos taurus</i>	646	39,9	468	21,9	82	20,7	424	28,3
<i>Sus</i> sp.	251	15,9	496	23,0	70	17,9	278	18,5
<i>Equus caballus</i>	25	1,6	15	0,7	5	1,3	22	1,5
<i>Cervus elaphus</i>	4	0,3	18 (15)	0,8	1 (1)	0,3	6 (3)	0,4
<i>Capra ibex</i>	4	0,3	7	0,3	–	0,0	3	0,2
<i>Capreolus capreolus</i>	–	0,0	5	0,2	1	0,3	3 (1)	0,2
<i>Bos</i> cf. <i>primigenius</i>	5	0,3	2	< 0,1	–	0,0	2	0,1
<i>Canis familiaris</i>	–	0,0	3	0,1	1	0,3	1	0,1
<i>Ursus arctos</i>	1	0,1	1	< 0,1	2	0,5	–	0,0
Ostalo / Rest	2	0,2	14	0,6	–	0,0	5	0,3
Σ det. fragm.	1576	100,0	2153	100,0	392	100,0	1500	100,0
Σ indet. fragm.	3189 (= 67,0 %N)		5139 (= 70,5 %N)		1039 (= 72,5 %N)		3536 (= 70,2 %N)	
SKUPAJ / TOTAL	4765		7292		1431		5036	

panosti posameznih taksonov pa sva za domače govedo, drobnico in prašiča, ki skupaj predstavljajo več kot 95 odstotkov vseh določenih najdb, izračunala še najmanjše število osebkov (MNI; tab. 8.6). Dobljeni rezultati v celoti potrjujejo razmerja iz tabele 8.4, kjer je številčnost najdb izražena kot NISP. Oba kazalnika abundance tako izkazuje pomembno zmanjšanje vloge goveda s pričetkom druge faze poznoantične poselitve Tonovcovega gradu, vzporedno s tem pa je pomen pridobila drobnica. Delež zastopanosti prašiča se skozi opazovano obdobje ni bistveno spreminjal; vrsta je bila za prebivalce Tonovcovega gradu sicer nedvomno pomembna, a njena vloga nikoli ni presegala vloge goveda in/ali drobnice. Podobno stalnost izkazuje tudi relativna frekvenca pojavljanja ostankov lovnih vrst. Ta v nobeni od faz ne presega poldruga odstotka NISP, kar je nedvoumen dokaz za kvantitativno skromen ekonomski pomen lova.

O vlogi posameznih vrst domačih živali v ekonomiji proučevanih skupnosti pričča tudi frekvenca zastopanosti posameznih skeletnih elementov (tab. 8.18). V primeru gradiva s Tonovcovega gradu večjih medfaznih razlik v tem pogledu ni zaznati pri nobenem od osrednjih taksonov (tab. 8.7). To se kaže tudi v razmeroma konstantnih deležih zastopanosti skeletnih elementov iz treh kvalitetnih kategorij<sup>20</sup> trupa goveda, drobnice in prašiča v času. Kot so pokazali rezultati testa  $\chi^2$ , namreč

<sup>20</sup> Vzorec porazdelitve skeletnih elementov v omenjene kvalitetne kategorije (tj. kategorije A, B in C) je podan v pogl. 8.1.

into it (see Tab. 8.5) were added to the assemblage from the Late Antiquity phase 2 in the rest of the analyses. In this we were allowed to operate with larger and thus more representative assemblages. The hypothesized presence of individual Early Medieval finds was not considered to be obtrusive, since their number is thought to be insignificant in the total assemblage.

Within the framework of this study of the mammalian macro-fauna at Tonovcov grad the abundance of individual taxa and/or (groups) of skeletal elements is expressed by the number of identifiable specimens (NISP). When comparing the contributions of individual taxa between the phases we also calculated the minimum number of individuals (MNI; Tab. 8.6) for domestic cattle, sheep, goats and pigs, which together represent over 95 percent of all finds. The results fully confirm those shown in table 8.4, where NISP has been used. Both abundance indicators (i.e. NISP and MNI) thus show a significant reduction in the role of cattle starting from the beginning of the Late Antiquity phase 2; at the same time caprines began gaining in importance. The share of pigs has not changed significantly throughout the observation period; they were certainly important for the inhabitants of Tonovcov grad, but their role never exceeded that of cattle and sheep. A similar continuity is shown in the relative frequency of game remains, which does not exceed 1.5 per cent of taxonomically identifiable specimens in any of the phases. Such a result

Tab. 8.5: Število določenih primerkov (NISP) za posamezne taksone velikih sesalcev v gradivu s Tonovcovega gradu, ki večinoma izvirajo iz druge poznoantične faze. Skupina 'Ostalo' vključuje: *Bos taurus* s. *Equus caballus* (N = 1) ter *Bos taurus* s. *Cervus elaphus* (N = 1). Pri cervidih je v oklepaju podano število ostankov rogovja.

Tab. 8.5: Number of identified specimens (NISP) for individual large mammalian taxa from Tonovcov grad, mostly originating from Late Antiquity phase 2. The group "Other" includes: *Bos taurus* s. *Equus caballus* (N = 1) and *Bos taurus* s. *Cervus elaphus* (N = 1). For cervids the number of antler remains is provided in brackets.

Takson / Taxon	NISP	% NISP
Caprinae	424	50,2
<i>Bos taurus</i>	214	25,4
<i>Sus</i> sp.	177	21,0
<i>Equus caballus</i>	20	2,4
<i>Cervus elaphus</i>	3 (1)	0,4
<i>Capra ibex</i>	1	0,1
<i>Capreolus capreolus</i>	1 (1)	0,1
<i>Bos</i> cf. <i>primigenius</i>	1	0,1
<i>Canis familiaris</i>	1	0,1
Ostalo / Rest	2	0,2
SKUPAJ / TOTAL	844	100,0

medfazna odstopanja pri nobenem od treh taksonov ne presegajo meje statistične značilnosti ( $\alpha = 0,05$ ).

Medfazna primerjava velikosti živali nekaterih bolje zastopanih sesalskih vrst je predstavljena v nadaljevanju (glej pogl. 8.5), starostna struktura za domače govedo, drobnico in prašiča pa na *sliki* 8.9 ter v *tabelah* 8.8–11. Navedeni podatki kažejo, da so nihanja v zastopanosti posameznih starostnih razredov v proučevanem obdobju pod mejo statistične značilnosti (test  $\chi^2$ :  $p > 0,05$ ). To pa samo po sebi še ne izključuje obstoja časovnih trendov, kar zadeva starost živine ob zakolu. Podrobnejša analiza podatkov o deležu kosti s še nezraščena ep- in diafizo (*tab.* 8.8–8.10) namreč nakazuje dvig povprečne starosti ob zakolu/poginu v drugi poznoantični fazi nasproti stanju v prvi poznoantični fazi v primeru vseh treh taksonov.<sup>21</sup> Količnik med številom še ne v celoti osificiranih kosti in pa številom tistih z že zraščena ep- in diafizo je v primeru prve poznoantične faze namreč statistično značilno večji od njegove vrednosti pri gradivu iz druge poznoantične faze tako v primeru drobnice ( $p = 0,005$ ) kot tudi prašiča ( $p = 0,000$ ).<sup>22</sup> Pri govedu podobno očitnih trendov sicer ni opaziti, se pa določene medfazne razlike kažejo tudi pri tej vrsti. Tako

<sup>21</sup> Podatki za zgodnjerednjeveško fazo v tej primerjavi niso bili upoštevani, saj je razpoložljivo število najdb preskromno.

<sup>22</sup> Izračun p-vrednosti temelji na t-vrednosti za posamezno primerjavo dveh pororcev (StatSoft, Inc. 2001).

Tab. 8.6: Najmanjše število osebkov (MNI) za tri najbolj zastopane taksone velikih sesalcev s Tonovcovega gradu. Legenda: PA – poznoantična faza; ZSV – zgodnjerednjeveška faza.

Tab. 8.6: Minimum number of individuals (MNI) for the three best represented large mammalian taxa at Tonovcov grad. Legend: LA – Late Antiquity phase; EMA – Early Medieval phase.

Takson / Taxon	PA 1 / LA 1	PA 2 / LA 2	ZSV / EMA
<i>B. taurus</i>	18	12	4
Caprinae	22	43	7
<i>Sus</i> sp.	8	14	3

Tab. 8.7: Obseg korelacije med deleži zastopnosti posameznih skeletnih elementov domačega goveda, drobnice in prašiča med tremi tukaj obravnavanimi poselitvenimi fazami Tonovcovega gradu. V tabeli so Spearmanovi r korelacijski koeficienti zapisani pokončno, Pearsonovi korelacijski koeficienti pa ležeče. Vsi korelacijski koeficienti so statistično značilni ( $\alpha = 0,05$ ). Legenda: PA – poznoantična faza; ZSV – zgodnjerednjeveška faza.

Tab. 8.7: Correlation between the shares of individual skeletal elements of cattle, sheep/goats and pigs originating from individual settlement phase at Tonovcov grad. The table shows the Spearman's r correlation coefficients written in normal font while the Pearson's correlation coefficients are written in italics. All correlation coefficients are statistically significant ( $\alpha = 0.05$ ). Legend: LA – Late Antiquity phase; EMA – Early Medieval phase.

PA 1 / LA 1			
	<i>Bos</i>	Capr.	<i>Sus</i>
<i>Bos</i>		0,92	0,77
Caprinae	0,95		0,79
<i>Sus</i>	0,86	0,89	
PA 2 / LA 2			
	<i>Bos</i>	Capr.	<i>Sus</i>
<i>Bos</i>		0,95	0,85
Caprinae	0,99		0,81
<i>Sus</i>	0,91	0,93	
ZSV / EMA			
	<i>Bos</i>	Capr.	<i>Sus</i>
<i>Bos</i>		0,86	0,79
Caprinae	0,88		0,79
<i>Sus</i>	0,79	0,86	

unambiguously indicates the (quantitatively) modest economic importance of hunting.

The economic role of animals of the studied community is also indicated by the frequency by which individual skeletal elements appear in the studied assemblage (*Tab.* 8.18). In the case of the material from Tonovcov grad no major inter-phase differences were noticed in any of the key taxa (*Tab.* 8.7). This is

Tab. 8.8: Število kosti domačega goveda s Tonovcovega gradu z nezraščena epi- in diafizo po starostnih skupinah. Posamezno skupino sestavljajo skeletni elementi, ki popolnoma osificirajo pri isti ontogenetski starosti (tj. v prvem, drugem, tretjem ali po tretjem letu življenja). Razlika med obema poznoantičnima fazama v zastopanosti že popolnoma osificiranih kosti in pa tistih s še nezraščena epi- in diafizo ni statistično značilna ( $\chi^2$  test:  $\chi^2 = 0,54$ ;  $p = 0,462$ ). Podatke o časovnem poteku zraščanja epi- in diafiz podaja Silver (1972). Legenda: PA – poznoantična faza; ZSV – zgodnj srednjeveška faza.

Tab. 8.8: Number of unfused cattle bones at Tonovcov grad by age groups. An individual age group is composed from skeletal elements that completely ossify at the same ontogenetic age (i.e. in the first, second, third or after the third year of life). The differences between Late Antiquity phases 1 and 2 in the representation of fused *versus* unfused bones is not statistically significant ( $\chi^2$  test:  $\chi^2 = 0.54$ ;  $p = 0.462$ ). Details on fusing phases of epi- and diaphysis are provided by Silver (1972). Legend: LA – Late Antiquity phase; EMA – Early Medieval phase.

Faza Phase	Starost Age	Epifiza / Epiphysis	
		Zraščena Fused	Nezraščena Unfused
PA 1	0–1	-	-
	1–2	22	2
	2–3	26	3
LA 1	3–	46	13
	Σ	94	18
PA 2	0–1	-	-
	1–2	33	2
	2–3	8	5
LA 2	3–	35	12
	Σ	76	19
ZSV	0–1	-	-
	1–2	1	1
	2–3	5	1
EMA	3–	2	2
	Σ	8	4

je delež kosti s še nezraščena epi- in diafizo v vzorcu ostankov, ki popolnoma osificirajo po koncu drugega leta starosti, v prvi poznoantični fazi statistično značilno manjši od tistega iz druge poznoantične faze ( $p = 0,027$ ). Velja poudariti, da je navedeni trend ravno nasproten od ugotovljenega pri drobnici in prašiču.

Spričo številnih pasti, vezanih na oceno starostne strukture populacij na podlagi podatkov o frekvenci pojavljanja kosti s še nezraščena epi- in diafizo (*cf.* Moran, O'Connor 1994), sva starost živali ob poginu/zakolu ocenila še na osnovi obrabe žvekalne površine kočnikov.

Tab. 8.9: Število kosti drobnice s Tonovcovega gradu z nezraščena epi- in diafizo po starostnih skupinah. Posamezno skupino sestavljajo skeletni elementi, ki popolnoma osificirajo pri isti ontogenetski starosti (tj. v prvem, drugem, tretjem ali po tretjem letu življenja). Razlika med obema poznoantičnima fazama v zastopanosti že popolnoma osificiranih kosti in pa tistih s še nezraščena epi- in diafizo ni statistično značilna ( $\chi^2$  test:  $\chi^2 = 2,95$ ;  $p = 0,085$ ). Podatke o časovnem poteku zraščanja epi- in diafiz podaja Silver (1972). Legenda: PA – poznoantična faza; ZSV – zgodnj srednjeveška faza.

Tab. 8.9: The number of unfused sheep/goat bones from Tonovcov grad by age groups. An individual age group is composed from skeletal elements that completely ossify at the same ontogenetic age (i.e. in the first, second, third or after the third year of life). The differences between Late Antiquity phases 1 and 2 in the representation of fused *versus* unfused bones is not statistically significant ( $\chi^2$  test:  $\chi^2 = 2.95$ ;  $p = 0.085$ ). Details on fusing phases of epi- and diaphysis are provided by Silver (1972). Legend: LA – Late Antiquity phase; EMA – Early Medieval phase.

Faza Phase	Starost Age	Epifiza / Epiphysis	
		Zraščena Fused	Nezraščena Unfused
PA 1	0–1	17	3
	1–2	4	1
	2–3	4	4
LA 1	3–	3	5
	Σ	28	13
PA 2	0–1	59	4
	1–2	18	1
	2–3	22	8
LA 2	3–	27	17
	Σ	126	30
ZSV	0–1	14	2
	1–2	6	2
	2–3	2	4
EMA	3–	4	8
	Σ	26	16

also reflected in the relatively constant shares of individual skeletal elements within the three qualitative categories<sup>21</sup> through time. The results of the  $\chi^2$  test showed that the variations do not exceed the level of statistical significance ( $\alpha = 0.05$ ) in any of the three best represented taxa.

The inter-phase comparison between the sizes of some of the better represented mammalian species is presented below (see chapter 8.5), while the mortality

<sup>21</sup> The division of skeletal elements into qualitative categories (i.e. categories A, B and C) is given in chapter 8.1.

Tab. 8.10: Število kosti prašiča s Tonovcovega gradu z nezraščeni epifizi in diafizo po starostnih skupinah. Posamezno skupino sestavljajo skeletni elementi, ki popolnoma osificirajo pri isti ontogenetski starosti (tj. v prvem, drugem, tretjem ali po tretjem letu življenja). Razlika med obema poznoantičnima fazama v zastopanosti že popolnoma osificiranih kosti in pa tistih s še nezraščeni epifizo ni statistično značilna ( $\chi^2$  test:  $\chi^2 = 2,11$ ;  $p = 0,147$ ). Podatke o časovnem poteku zraščanja epifize in diafize podaja Silver (1972). Legenda: PA – poznoantična faza; ZSV – zgodnjesevrednješka faza.

Tab. 8.10: The number of unfused pig bones from Tonovcograd by age groups. An individual group is composed from skeletal elements that completely ossify at the same ontogenetic age (i.e. in the first, second, third or after the third year of life). The differences between Late Antiquity phases 1 and 2 in the representation of fused *versus* unfused bones is not statistically significant ( $\chi^2$  test:  $\chi^2 = 2.11$ ;  $p = 0.147$ ). Details on fusing phases of epiphysis and diaphysis are provided by Silver (1972). Legend: LA – Late Antiquity phase; EMA – Early Medieval phase.

Faza Phase	Starost Age	Epifiza / Epiphysis	
		Zraščena Fused	Nezraščena Unfused
PA 1	0-1	-	-
	1-2	9	5
	2-3	8	6
LA 1	3-	3	5
	Σ	20	21
PA 2	0-1	-	-
	1-2	22	8
	2-3	17	7
LA 2	3-	2	9
	Σ	41	24
ZSV	0-1	-	-
	1-2	3	-
	2-3	6	4
EMA	3-	-	3
	Σ	9	7

Žal je bilo v primeru goveda razpoložljivih podatkov za reprezentativno oceno starostne strukture premalo; uporabila sva namreč metodologijo Grantove (1982), ki ne omogoča analize posameznih izoliranih zob. Od le šestih zadovoljivo ohranjenih spodnjih čeljustnic jih pet izvira iz prve poznoantične faze, ena pa iz druge. Slednja je domnevno pripadala okrog tri leta stari živali (M.W.S. = 37),<sup>23</sup> medtem ko so v prvi poznoantični fazi s štirimi najdbami prevladovali primerki nad 3,5 leta

<sup>23</sup> M.W.S. – stopnja obrabe spodnje čeljustnice (*Mandibular Wear Stage*; Grant 1982)

profiles of cattle, caprines and pig are illustrated in figure 8.9 and in tables 8.8-8.11. The data suggest that the variations in the representation of various age classes are below the level of statistical significance ( $\chi^2$  test:  $p > 0.05$ ). This in itself does not exclude the existence of diachronic trends as regards the age of the domesticates at culling. Namely, a detailed analysis of the data on relative abundance of unfused bones (Tabs. 8.9-8.10) suggests that the average age at death might have been on the rise during the Late Antiquity phase 2 (compared to Late Antiquity phase 1) for both caprines and pig,<sup>22</sup> with the inter-phase differences being statistically highly significant ( $p = 0.005$  and  $p = 0.000$ , respectively).<sup>23</sup> Contrary to this, in the case of cattle the contribution of unfused bones among the completely ossified remains after the completion of the second year of age is statistically significantly lower in the Late Antiquity phase 1 than in Late Antiquity phase 2 ( $p = 0.027$ ).

Given the number of uncertainties related to the assessment of the population mortality profile based on the unfused bones (*cf.* Moran, O'Connor 1994), molar eruption and attrition sequences were also considered. In the case of cattle Grant's (1982) methodology was used, which unfortunately, does not allow for the analysis of individual isolated teeth. Consequently, no sufficient data were available from which a representative mortality profile could be constructed. Of the six sufficiently preserved mandibles five originate from the Late Antiquity phase 1 and one from the Late Antiquity phase 2. The latter possibly belonged to an approximately three years old animal (MWS = 37)<sup>24</sup>, while Late Antiquity phase 1 finds consisted of four specimens belonging to over 3.5 years old cattle (MWS = 41-45) and a mandibula of a 10 to 12 weeks old calf (MWS = 10-11). These data thus fit well with the one from table 8.8, as in both cases Late Antiquity phase 1 shows the preferential culling of adult animals (i.e. over three years old). A similar comparison on the level of the remaining two settlement phases is rendered impossible by small assemblage sizes.

In the case of caprines and pigs we had more data available on the age at death, for the methodology used also allowed for the analysis of isolated teeth (*cf.* Payne 1973; Rolett, Chiu 1994). Nevertheless, in the inter-phase comparisons we have limited ourselves to the comparison between the two best represented i.e. Late Antiquity phases 1 and 2. Similarly to what has been observed while analyzing the relative abundance of unfused bones, the study of tooth wear showed an absence

<sup>22</sup> The data for the Early Medieval phase were not taken into account in this comparison due to the insufficient number of finds.

<sup>23</sup> The calculation of the p-value is based on the t-value for the individual comparison between the two ratios (StatSoft, Inc. 2001).

<sup>24</sup> MWS – *Mandibular Wear Stage* (Grant 1982)

Tab. 8.11: Starost domačih prašičev s Tonovcovega gradu, kot izhaja iz obrabe žvekalne površine kočnikov (cf. Rolett, Chiu 1994). Razlika v zastopanosti posameznih starostnih razredov med obema poznoantičnima fazama ni statistično značilna ( $\chi^2$  test:  $\chi^2 = 2,56$ ;  $p > 0,200$ ). Legenda: SA – subadulten (tj. 5/8 do 10/14 mesecev); YA – mlad adulten (tj. 10/14 do 18/26 mesecev); MA – adulten (tj. nad 18/26 mesecev); PA – poznoantična faza; ZSV – zgodnjesevrednjevska faza.

Tab. 8.11: The age at death for pigs from Tonovcov grad, as shown by molar wear (cf. Rolett, Chiu 1994). The difference in the representation of individual age groups between Late Antiquity phases 1 and 2 is not statistically significant ( $\chi^2$  test:  $\chi^2 = 2.56$ ;  $p > 0.200$ ). Abbreviations: SA – subadult (i.e. 5/8 to 10/14 months); YA – young adult (i.e. 10/14 to 18/26 months); MA – mature adult (i.e. above 18/26 months). Legend: LA – Late Antiquity phase; EMA – Early Medieval phase.

starih goved (M.W.S. = 41–45). V tem smislu je bila edina izjema čeljustnica 10 do 12 tednov starega teleta (M.W.S = 10–11). Navedeni podatki se tako ujemajo s tistimi iz *tabele* 8.8. Kar zadeva prvo fazo poznoantične poselitve Tonovcovega gradu, namreč oboji izkazujejo večinski zakol odraslih (tj. nad tri leta starih) živali; primerjava na nivoju preostalih dveh faz je zavoljo le enega razpoložljivega podatka nemogoča.

V primeru drobnice in prašiča je razpoložljivih podatkov o starosti živali ob poginu/zakolu več, saj je uporabljena metodologija omogočala tudi analizo izoliranih zob (cf. Payne 1973; Rolett, Chiu 1994). Kljub temu sva se pri medfaznih primerjavah omejila le na vzporedbo dveh bogateje zastopanih faz, tj. prve in druge poznoantične faze. Podobno kot že analiza zastopanosti še ne popolnoma osificiranih kosti je tudi študija obrabe žvekalne površine zob pokazala na odsotnost statistično značilnih razlik v starostni strukturi med obema fazama tako v primeru drobnice (*sl.* 8.9) kot tudi prašiča (*tab.* 8.11). Celo več. Na podlagi podatkov o obrabi zob ni mogoče govoriti niti o obstoju kakršnega koli trenda, ki bi kazal na dvig povprečne starosti ob zakolu. Količnik med številom meljakov juvenilnih, subadultnih in mladih adultnih živali na eni strani ter številom meljakov (starih) adultnih primerkov na drugi se v gradivu iz prve poznoantične faze namreč statistično ne razlikuje od vrednosti za drugo poznoantično fazo pri nobenem od treh meljakov pri nobenem od obeh taksonov. Iz tega je mogoče sklepati, da zgoraj navedeni povečan delež še ne popolnoma osificiranih kosti drobnice in prašiča v drugi poznoantični fazi (*tab.* 8.9–8.10) pravzaprav ne odraža dejanske spremembe v gospodarjenju z živino na začetku 6. stoletja, ampak da gre predvsem za posledice delovanja različnih pred- in poodložitvenih dejavnikov.

### 8.3.1 TAFONOMIJA

Arheozoološka informacija, zajeta v favnističnem vzorcu, je praviloma do neke mere zamegljena zavoljo

Faza / Phase	Starost / Age	SA	YA	MA
PA 1	M <sub>1</sub>	3	3	2
	M <sub>2</sub>	-	3	1
LA 1	M <sub>3</sub>	-	2	2
	Σ	3	8	5
PA 2	M <sub>1</sub>	8	7	4
	M <sub>2</sub>	6	1	3
LA 2	M <sub>3</sub>	-	3	3
	Σ	14	11	10
ZSV	M <sub>1</sub>	2	-	-
	M <sub>2</sub>	-	-	1
EMA	M <sub>3</sub>	-	-	-
	Σ	2	-	1

of statistically significant differences in the mortality profiles between the two Late Antiquity phases both in the case of caprines (*Fig.* 8.9) and for pig (*Tab.* 8.11). Based on the latter data it is not even possible to confirm the trend of a slight rise in the average age at culling. After all, in the material from the Late Antiquity phase 1 the quotient between the number of juvenile, subadult and young adult molars on the one hand and the number of (old) adult molars on the other is not statistically different from the values relevant to the Late Antiquity phase 2 at any of the three molars for neither of the two taxa. It follows that the increase in the share of unfused caprine and pig bones dated to the Late Antiquity phase 2 (*Tabs.* 8.9–8.10) most probably does not truly reflect the actual changes in livestock management in the early 6<sup>th</sup> century, but might rather be the result of various pre- and post-depositional factors.

### 8.3.1 TAPHONOMY

The arheozoological information obtained from the faunal assemblage is to a certain extent blurred by the various biotic and abiotic post-depositional factors, whose role is hard to define *a posteriori*. This should definitely be taken into account in the evaluation of the mortality profiles. It is a known fact that dogs can destroy most of the smaller bones, i.e. bones with a lower structural density<sup>25</sup> (e.g. Payne, Munson 1985; Marean, Spencer 1991, 656; Lyman 1999, 325 ff; Cleghorn, Marean 2004), and therefore significantly distort the original relationship

<sup>25</sup> The same holds true for pigs (Greenfield 1988). Moreover, the remains of lower structural density also show a more intensive/faster disintegration within the sediment (Outram 2004, 172 f).



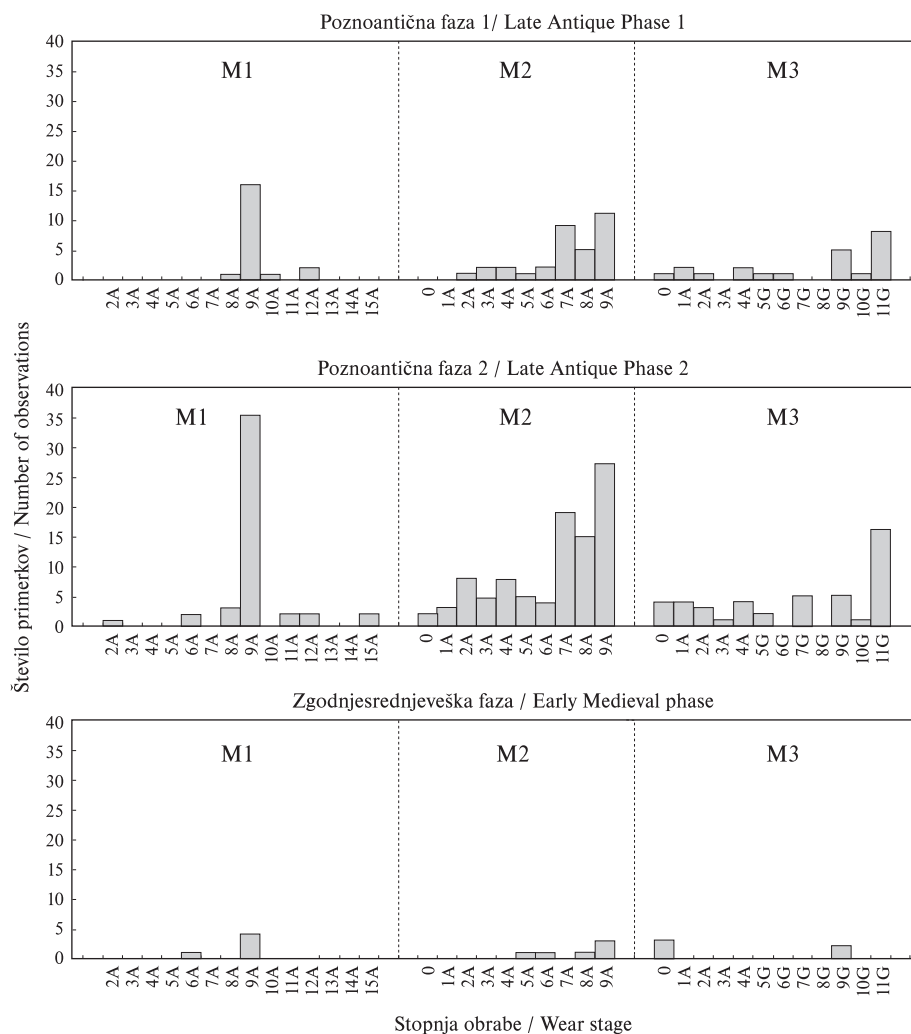

Sl. 8.9: Stopnja obrabe kočnikov pri drobnici s Tonovcovega gradu (cf. Payne 1973). Simbole za označbo posameznih stopenj obrabe podaja Payne (1987, 610). Razlika med obema poznoantičnima fazama v zastopanosti drugih spodnjih meljakov z različno stopnjo obrabe žvekalne površine ni statistično značilna ( $\chi^2$  test:  $\chi^2 = 4,239$ ;  $p < 0,999$ );  $M_2$  je bil izbran zato, ker je v obravnavanem vzorcu zastopan z največjim številom primerkov.

Fig. 8.9: Level of molar wear at sheep and goats from Tonovcov grad (cf. Payne 1973). The symbols for marking individual levels of wear is provided by Payne (1987, 610). The difference between Late Antiquity phases 1 and 2 in the wear of second lower molars ( $M_2$ ) is not statistically significant ( $\chi^2$  test:  $\chi^2 = 4.239$ ;  $p < 0.999$ );  $M_2$  was chosen because it is the best represented tooth in the analysed material.

delovanja različnih biotskih in abiotskih podložitev-  
nih dejavnikov, katerih vlogo je *a posteriori* zelo težko  
opredeliti. Tega se je treba zavedati tudi pri ocenjevanju  
starostne strukture živali ob zakolu. Znano je namreč, da  
psi lahko zgrizejo večino manjših kosti oz. kosti z manjšo  
strukturno gostoto<sup>24</sup> (npr. Payne, Munson 1985; Marean,  
Spencer 1991, 656; Lyman 1999, 325 ss; Cleghorn, Marean  
2004) ter s tem pomembno popačijo izvirno razmerje  
med posameznimi starostnimi razredi. Vzorci z neso-  
razmerno velikim številom distalnih delov nadlahnic  
nasproti proksimalnim tako zelo verjetno izkazujejo tudi

<sup>24</sup> Podobno velja za prašiče (Greenfield 1988), ostanki z  
manjšo strukturno gostoto pa izkazujejo tudi intenzivnejše/  
hitrejše razpadanje v sedimentu (Outram 2004, 172 s).

between the age classes. Samples with a disproportionately  
large number of humeral distal ends relative to proximal  
ones (the latter being characterized by a significantly  
lower structural density) are thus highly likely to show  
also an underestimation of the mandibles of young  
animals (when compared to the number attributed to  
mature specimens). As the experiment carried out by  
Payne and Munson (1985, 34 ff) showed, dogs are able  
to entirely destroy the lower jawbones of lambs (includ-  
ing numerous deciduous teeth), while (at least) parts  
of mandibles of adult sheep and goats with permanent  
molars are preserved.

The ratio between the number of caprine humerus  
distal and proximal ends amongst the material from

podcenjen delež spodnjih čeljustnic mladih živali glede na število tistih, ki jih gre pripisati že odraslim. Kot sta s poskusom pokazala Payne in Munson (1985, 34 ss), psi lahko v celoti uničijo spodnje čeljustnice jagenjčkov in kozličev (z mnogimi mlečnimi zobmi vred), medtem ko se posamezni deli mandibul odraslih ovac in koz z že stalnimi kočniki praviloma ohranijo.

Razmerje med številom distalnih in proksimalnih delov nadlahtnic drobnice v gradivu iz obeh poznoantičnih faz s Tonovcovega gradu znaša 4 : 1 v korist prvih, kar nakazuje zmerno destruktivno aktivnost psov (cf. Munson 2000, 400 s). Skromen (tj. < 1 %) delež ostankov z odtisi zob v tem smislu ni problematičen, saj zanemarljivo število obgrizenih kosti samo po sebi še ne gre vnaprej razumeti kot kazalnik manjše destruktivne aktivnosti psov ali celo njen izostanek (Kent 1981, 370; Payne, Munson 1985, 34). Podobno razmerje med številom distalnih in proksimalnih delov nadlahtnic drobnice je bilo ugotovljeno tudi v modernem sezonskem taboru plemena Navajo,<sup>25</sup> ki je bil predmet aktualistične študije posledic pasjega mrhovinarstva na ovčjih kosteh. Na podlagi rezultatov navedene raziskave in še nekaterih podobnih je Munson (2000, 400) izpeljal oceno obsega uničenja kosti in zob drobnice posameznih starostnih razredov s strani psov. Ta mu je služila kot izhodišče za izpeljavo novih, korigiranih frekvenc zastopanosti posameznih zob, ki naj bi omogočile izračun verodostojnejših ocen starostne strukture živali ob zakolu. Korigirane frekvence zastopanosti za posamezne zobe drobnice s Tonovcovega gradu podajava v tabeli 8.12.

Late Antiquity phases 1 and 2 at Tonovcov grad is 4:1 in favour of the former, which suggests that there was a moderate destructive activity by dogs (cf. Munson 2000, 400 f). This is not necessarily in contradiction with the observed modest (i.e. < 1 %) proportion of gnawed remains, for the negligible number of such bones in itself is not seen as an indicator of less destructive dog activities, or even its absence (Kent 1981, 370; Payne, Munson 1985, 34). A similar ratio of caprine humerus distal and proximal ends as in the case of Tonovcov grad was found also in a modern seasonal camp of the Navajo tribe,<sup>26</sup> which was the subject of a current study of the effects of dogs ravaging sheep bones. On the basis of these results and that of several similar studies, Munson (2000, 400) estimated the extent of sheep/goat teeth destruction caused by dogs by multiplying the observed numbers of teeth in individual age classes by the inverses of the survival rates from the aforementioned Navajo dog-ravaged assemblage. This allowed him to construct a corrected for ravaging mortality profile which was much more realistic. Analogously corrected mortality profile for caprines from Tonovcov grad is given in table 8.12.

It is known that the sheep/goat fourth lower deciduous premolars fall out roughly at the same time as the third lower molars start erupting (cf. Moran, O'Connor 1994, 277 f). The mortality profile that would be based on the wear of the  $dp_4$  and  $M_3$  specimens included in the studied assemblage would encompass all age classes and thus fulfil one of the key conditions for its credibility. Let us take a look at the corrected relative

Tab. 8.12: Podatki o dejanskih in korigiranih frekvencah pojavljanja mlečnih četrth spodnjih predmeljakov in tretjih spodnjih meljakov drobnice po starostnih razredih za gradivo iz obeh poznoantičnih faz s Tonovcovega gradu. Postopek izračunavanja korigiranih frekvenc podaja Munson (2000, 400). Zvezda (\*) označuje približne vrednosti.

Tab. 8.12: The data on the actual and corrected frequencies of deciduous fourth lower premolars and third lower molars of sheep and goats by age groups for the material from Late Antiquity phases 1 and 2 at Tonovcov grad. The process for calculating the corrected frequencies is provided by Munson (2000, 400). The asterisk (\*) denotes approximate values.

Starost (v letih) Age (in years)	Poznoantična faza 1 / Late Antiquity phase 1				Poznoantična faza 2 / Late Antiquity phase 2			
	Dejanski podatki Actual data		Korigirani podatki Corrected data		Dejanski podatki Actual data		Korigirani podatki Corrected data	
	N	%	N	%	N	%	N	%
0-1	4	7*	29,6	51,6	18	27*	133,3	74,3
1-2	3	93*	5,1	8,9	1	73*	1,7	1,0
2-3	5		5,5	9,5	12		13,1	7,3
3-4	9		9,1	15,9	15		15,3	8,5
4-	8		8,0	14,1	16		16	8,3
Σ	29	100,0	57,3	100,0	62	100,0	179,4	100,0

Znano je, da se pri drobnici obdobje izpada mlečnih četrth spodnjih predmeljakov v grobem ujema z obdobjem izraščanja tretjih spodnjih meljakov (cf. Moran,

<sup>25</sup> Ugotovljeno razmerje med številom distalnih in proksimalnih koncev nadlahtnic je tu znašalo 4,7 : 1 (Munson 2000, 400 s).

abundances of caprine deciduous  $P_4$  and the  $M_3$  teeth for each individual age class in the material from the two Late Antiquity phases at Tonovcov grad (Table 8.12). The

<sup>26</sup> In this case the ratio established between the number of distal and proximal humerus parts was 4.7 : 1 (Munson 2000, 400 f).

O'Connor 1994, 277 s). Starostna struktura, ki bi temeljila na stopnji obrabe žvekalne površine razpoložljivih primerkov omenjenih dveh zob v proučevanem vzorcu, bi tako zajela vse starostne razrede ter s tem izpolnila enega ključnih pogojev za njeno verodostojnost. Poglejmo si korigirane frekvence pojavljanja mlečnih  $P_4$  in  $M_3$  ovac in koz posameznega starostnega razreda v gradivu iz prve in druge faze poznoantične poselitve Tonovcovega gradu (tab. 8.12). Razlika v deležu zastopanosti posameznega starostnega razreda med obema fazama je nad mejo statistične značilnosti (test  $\chi^2$ :  $\chi^2 = 16,11$ ;  $p < 0,010$ ), kar sicer za analogno primerjavo, temelječo na dejanskih frekvencah pojavljanja obravnanih zob, ne velja (test  $\chi^2$ :  $\chi^2 = 6,18$ ;  $p > 0,200$ ). Ob upoštevanju korigiranih frekvenc pojavljanja najdb je razlika med fazama večja, tudi kar zadeva vrednost količnika med številom vseh zob do enega leta starih živali in številom tistih pripadajočih nad leto dni starim ovcam in kozam; medfazna razlika sicer v obeh primerih presega mejo statistične značilnosti.<sup>26</sup>

Predstavljeni rezultati postavljajo pod vprašaj ugotovitve, ki jih je bilo mogoče izpeljati iz podatkov o številčnosti še neosificiranih kosti drobnice nasproti tistim z že zraščeni ep- in diafizo. Ker je slednjih v gradivu iz prve poznoantične faze relativno manj kot med ostanki iz druge poznoantične faze (tab. 8.9), bi lahko to namreč nakazovalo časovni trend višanja povprečne starosti drobnice ob zakolu. Na drugi strani se zdi v luči podatkov iz tabele 8.12 takšno domnevo smiselno ovreči, pri čemer pa ostajajo razlogi za obstoj razlike med obema starostnima krivuljama nepojasnjena. Delno gre razliko med njima seveda pripisati dejstvu, da korigirani podatki iz tabele 8.12 vsaj delno upoštevajo manko zob mladih živali, medtem ko v primeru podatkov iz tabele 8.9 ni tako. Zanimivo pa bi bilo tudi raziskati, v kolikšni meri ugotovljena slika odraža delovanje človeka (cf. Maltby 1982; O'Connor 1991).

V ta namen sva za vsako od obeh faz število še ne popolnoma osificiranih distalnih koncev nadlahtnice in golenice ter proksimalnih koncev koželjnice primerjala s številom četrnih mlečnih spodnjih predmeljakov in tretjih spodnjih meljakov (tab. 8.13). Na istem mestu podajava tudi podatke o številu že v celoti osificiranih proksimalnih koncev nadlahtnice in golenice ter distalnih koncev stegenice nasproti številu  $M_3$  s stopnjo obrabe najmanj 5G (*sensu* Payne 1987, 610), prav tako ločeno za vsako od obeh poznoantičnih faz. Osifikacija distalnega konca nadlahtnice in golenice oz. proksimalnega konca koželjnice naj bi se pri ovci končala do konca drugega leta življenja (Silver 1972, Tab. A),<sup>27</sup> kar v

<sup>26</sup> Dejanske frekvence pojavljanja zob:  $p = 0,021$ ; korigirane frekvence pojavljanja zob:  $p = 0,000$ . Izračun  $p$ -vrednosti temelji na  $t$ -vrednosti za posamezno primerjavo dveh pororcev (StatSoft, Inc. 2001).

<sup>27</sup> Gre le za približno oceno, ki ne upošteva znotrajvrstne variabilnosti na račun pasme, spola, življenjskih pogojev, na-

inter-phase difference in the representation of various age classes is above the level of statistical significance ( $\chi^2$  test:  $\chi^2 = 16.11$ ,  $p < 0.010$ ) and thus differs from the results of the analogous comparison based on the actual (i.e. observed) frequencies in which the studied teeth occurred ( $\chi^2$  test:  $\chi^2 = 6.18$ ,  $p > 0.200$ ). Taking into account the corrected abundances of deciduous  $P_4$  and the  $M_3$  the inter-phase difference is greater also with regard to the value of the quotient between the number of all teeth of up to one year old animals and the number of those belonging to sheep and goats over one year old.<sup>27</sup>

These results question the conclusions that could be derived from the data on the number of unfused caprine bones compared to their fused counterparts. Namely, Late Antiquity phase 1 material includes fewer of the latter (in comparison with material from Late Antiquity phase 2, Tab. 8.9), thus indicating a trend of increasing the average age of sheep/goat at culling which might be the reasons behind the observed difference between the two (i.e. bone- vs. teeth-based) mortality profiles. There are no doubts that to a certain degree it should be due to the fact that the corrected data in table 8.12 at least partially take into account the lack of teeth of young animals, which is not the case for data in table 8.9. Other factors resulting in taphonomic loss should also be taken into account. But what about human influence? Is the observed discrepancy between the two profiles attributable also to the activities of the local population (cf. Maltby 1982; O'Connor 1991)?

To this effect we have compared the numbers of unfused humerus and tibia distal ends with the abundance of radius proximal ends on one side with the number of deciduous fourth lower premolars and third lower molars on the other between the two Late Antiquity phases (Tab. 8.13). Added to this is the information on the number of fused humerus and tibia proximal parts as well as femur distal ends versus the number of  $M_3$  worn to at least stage 5G (*sensu* Payne 1987, 610) – separately for Late Antiquity phases 1 and 2. Within sheep the ossification of the humerus and tibia distal ends and of the radius proximal end should be completed by the conclusion of the second year of life (Silver 1972, Tab. A),<sup>28</sup> which roughly coincides with the loss of deciduous  $P_4$  or the beginning of wear of  $M_3$  (Payne 1973; Moran, O'Connor 2004, 277 ff). On the other hand, the proximal epiphysis of humerus and tibia or the distal epiphysis

<sup>27</sup> The actual abundance of tooth eruption:  $p = 0.021$ ; corrected abundance of tooth eruption:  $p = 0.000$ . The calculation of the  $p$ -value is based on the  $t$ -value for each individual comparison between the two proportions (StatSoft, Inc. 2001).

<sup>28</sup> This is an approximate estimate which does not take into account the variability within species that occurs due to breed, sex, living conditions, way of breeding, etc. (Moran, O'Connor 2004, 272 ff). Similar also holds true for the comparison between the age at death on the basis of molar eruption and attrition sequences (Moran, O'Connor 2004, 268 ff).

grobem sovпада z izpadanjem mlečnih  $P_4$  oz. začetkom obrabe stalnih  $M_3$  (Payne 1973; Moran, O'Connor 2004, 277ss). Po drugi strani se zraščanje proksimalne epifize z diafizo pri nadlahtnici in golenici oz. distalne epifize z diafizo pri stegenici konča po dopolnitvi tretjega leta starosti (Silver 1972, Tab. A), ko stopnja obrabe žvekalne površine tretjih spodnjih meljakov praviloma ustreza stopnji 5G (Payne 1973; Moran, O'Connor 2004, 277ss). Količnik med številom še ne osificiranih kostnih fragmentov ter skupnim številom vseh mlečnih  $P_4$  in še neobrabiljenih  $M_3$  gre tako razumeti kot kazalnik abundance kranialnih in postkranialnih ostankov mladih živali v obravnavanem vzorcu. V nasprotju s tem količnik med številom že popolnoma osificiranih kosti in tretjimi spodnjimi meljaki s stopnjo obrabe najmanj 5G kaže na številčnost obeh skupin ostankov pri odraslih, nad tri leta starih ovcah in kozah.

Kot je razvidno iz *tabele 8.13*, je med ostanki mladih živali razmerje med številom kosti in zob v prvi poznoantični fazi zgolj 1 : 2 v korist slednjih, medtem ko znaša za gradivo iz druge poznoantične faze kar 1 : 6,75. Obratno sliko kaže primerjava obeh faz v vrednosti količnika med številom kosti in zob odraslih ovac in koz, saj je tu razmerje v prvi poznoantični fazi kar 1 : 5,7 v korist zob, medtem ko znaša v primeru druge poznoantične faze komaj 1 : 1,6. Iz navedenega izhaja, da gradivo iz druge faze poznoantične poselitve Tonovcovega gradu izkazuje manko<sup>28</sup> ostankov postkranialnega skeleta juvenilnih ovac in koz nasproti zobem primerljivo starih živali, ki ga ni mogoče razložiti zgolj z različno intenzivnim poodložitvenim razpadanjem ene in druge skupine ostankov. Čeprav je bilo gradivo iz prve poznoantične faze deponirano v enakem sedimentu kot tisto iz druge (in to celo za nekaj deset let daljše obdobje), je namreč manko juvenilnih kosti okončin drobnice nasproti zobem v omenjenem vzorcu vendarle manj izrazit.<sup>29</sup> Podatke iz *tabele 8.13* je tako mogoče razumeti kot indic za to, da so bile med drugo fazo poznoantične poselitve glave mladih ovac in koz deponirane (procesirane?) na drugih lokacijah, kot to velja za njihove trupe (cf. Maltby 1982, 86).<sup>30</sup> Na nekatera očitna nesorazmerja v deležu zastopanosti različnih delov trupa je ne nazadnje pokazalo tudi vzporejanje

čina reje ipd. (Moran, O'Connor 2004, 272 ss). Podobno velja tudi za vzporejanje starosti s stopnjo obrabe žvekalne površine kočnikov (Moran, O'Connor 2004, 268 ss).

<sup>28</sup> V gradivu iz druge poznoantične faze je delež kosti med vsemi (tj. kosti in zobje) ostanki mladih živali statistično značilno manjši od deleža kosti med vsemi ostanki odraslih, več kot tri leta starih ovac in koz (test  $\chi^2$ :  $\chi^2 = 5,93$ ;  $p = 0,015$ ).

<sup>29</sup> V gradivu iz prve poznoantične faze se delež kosti med vsemi (tj. kosti in zobje) ostanki mladih živali statistično značilno ne razlikuje od deleža kosti med vsemi ostanki odraslih, več kot tri leta starih ovac in koz (test  $\chi^2$ :  $\chi^2 = 1,48$ ;  $p = 0,232$ ).

<sup>30</sup> Žal specifično težo rezultatom in njihovim interpretacijam zmanjšuje pičlo število razpoložljivih najdb, kar velja predvsem za prvo poznoantično fazo.

*Tab. 8.13*: Frekvenca zastopanosti ostankov drobnice iz skupin A, B, C in D v obeh poznoantičnih fazah (= PA 1 in 2) s Tonovcovega gradu. Skupina A vključuje še ne v celoti osificirane primerke distalnih koncev nadlahtnice in golenice ter proksimalnih koncev koželjnice, skupina B vključuje mlečne četrte spodnje predmeljake in tretje spodnje meljake brez obrabe žvekalne površine, skupina C vključuje že v celoti osificirane primerke proksimalnih koncev nadlahtnice in golenice ter distalnih delov stegenice, skupina D pa tretje spodnje meljake s stopnjo obrabe najmanj 5G (*sensu* Payne 1987, 610).

*Tab. 8.13*: The frequency of sheep/goat remains from groups A, B, C and D in the material from the Late Antiquity phases (= LA) 1 and 2 at Tonovcov grad. Group A includes not yet fused distal humeri and tibiae as well as fused proximal radii, group B includes deciduous fourth lower premolars and unworn third lower molars, group C includes fused proximal humeri and tibiae as well as distal femora, while group D includes third lower molars worn at least to the stage 5G (*sensu* Payne 1987, 610).

Skupina Group	PA 1 LA 1	PA 2 LA 2
A	4	4
B	8	27
C	3	19
D	17	31

of femur fuse by the end of the third year of life (Silver 1972, Tab. A), i.e. when the third lower molar is usually worn to stage 5G (Payne 1973; Moran, O'Connor 2004, 277 ff). The quotient between the number of unfused bone fragments of the aforementioned skeletal elements and the total number of deciduous  $P_4$  and unworn  $M_3$  teeth indicates the abundance of cranial vs. postcranial skeletal element remains from juveniles. In contrast, the quotient between the number of fused bones and the third lower molars worn to at least stage 5G reflects the abundance of both groups of remains belonging to adult (roughly three years old or more) sheep and goats.

Among the remains of juvenile animals from Late Antiquity phase 1 the ratio between the number of aforementioned bones and teeth is a mere 1:2 in favour of the latter, while in Late Antiquity phase 2 this ratio rises to 1:6.75 (*Tab. 8.13*). A different picture emerged from the analysis of the remains of adults. Here the ratio between the number of bones from the postcranial skeleton and teeth dated to the Late Antiquity phase 1 shows a value as high as 1:5.7 in favour of teeth, whereas in Late Antiquity phase 2 the same quotient amounts to a mere 1:1.6. It follows that the material from the Late Antiquity phase 2 shows a lack<sup>29</sup> of juvenile sheep and

<sup>29</sup> In the material from Late Antiquity phase 2 the share of bones amongst all (i.e. bones and teeth) young animal remains is statistically significantly lower than the share of bones amongst all adult remains (three years or more). The data is for sheep and goat remains ( $\chi^2$  test:  $\chi^2 = 5.93$ ;  $p = 0.015$ ).

števila najdb posameznih elementov apendikularnega skeleta (sl. 8.27–8.28).

Podatek o “primanjkljaju” ostankov postkranialnih skeletnih elementov mladih ovac in koz v gradivu iz druge poznoantične faze pa ima implikacije, tudi kar zadeva zgoraj omenjeno razliko med obema razpoložljivima starostnima strukturama za omenjeni vrsti: tisto, ki temelji na deležu še ne popolnoma osificiranih kosti (tab. 8.9), in ono, ki izhaja iz stopnje obrabe žvekalne površine kočnikov (tab. 8.13). Ker je bil v drugi poznoantični fazi namreč pomemben del kosti postkranialnega skeleta domnevno deponiran zunaj meja izkopnega polja, je ugotovljeni delež še ne popolnoma osificiranih kosti med ostanki drobnice iz te faze (močno?) podcenjen. Posledično lahko označimo za neutemeljena tudi vsa iz table 8.9 izhajajoča razmišljanja o povišanju povprečne starosti ovac in koz ob zakolu/poginu s pričetkom druge faze poznoantične poselitve Tonovcovega gradu. Obenem pa bistveno večjo težo pridobijo rezultati analize stopnje obrabe žvekalne površine kočnikov (tab. 8.13), ki kažejo na večinski zakol/pogin do enega leta starih ovac in koz tako v prvi kot tudi v drugi poznoantični poselitveni fazi, pri čemer je ta delež v okviru slednje celo statistično značilno večji.

#### 8.4 PORAZDELITEV NAJDB V PROSTORU

Daleč največ favnističnih najdb s Tonovcovega gradu<sup>31</sup> je bilo pobranih na območju okrog stavbe 1 (tj. 17.282 oz. 95,9 % vseh izkopanih ostankov), medtem ko jih je raziskovanje vodnega zbiralnika navrglo le 21.<sup>32</sup> Podatki o številu najdb posameznih taksonov po območjih so podani v prilogi 8.2. Zaradi pičlega števila ostankov znotraj večine vzorcev podrobnejša analiza porazdelitve najdb v prostoru ni mogoča, preliminarna primerjava deležev zastopanosti posameznih taksonov med vzorci pa, vsaj kar zadeva gradivo iz prve poznoantične in pa zgodnesrednjeveške faze, ne kaže opaznejših razlik. Nekoliko večjo heterogenost izkazuje porazdelitev najdb goveda, drobnice in prašiča v prostoru med drugo fazo poznoantične porazdelitve, ko so tudi razpoložljivi favnistični vzorci največji (sl. 8.10). Izstopa predvsem vzorec s prostora med cerkvami, ki je edini izmed petih z večinskim deležem najdb goveda (pril. 8.2: tab. D). V tem smislu tako omenjeni vzorec izkazuje podobnost predvsem z gradivom iz prve poznoantične faze, kjer je bilo govedo prav tako najbolje

<sup>31</sup> Med večletnimi izkopavanji so bili raziskani ostanki cerkvenega kompleksa ter še treh stavb in vodnega zbiralnika (Modrijan 2007).

<sup>32</sup> Ob 16 nedoločljivih fragmentih je vzorec vključeval tudi odlomek goveje rožnice, kozje lopatice ter zgornje čeljustnice, zoba ( $M_2$ ) in distalnega konca koželjnice drobnice. Vsi ostanki so datirani v drugo poznoantično fazo.

goat finds of postcranial skeletal elements compared to the teeth of animals of the same age group, which cannot be explained solely by the differential taphonomic loss. Although the material from Late Antiquity phase 1 was deposited within the same sediment as that from the Late Antiquity phase 2 (even for a period lasting a few decades longer), the lack of juvenile sheep/goat bones from the postcranial skeleton compared to teeth remains of animals of the same age is much less pronounced in this assemblage.<sup>30</sup> The data from table 8.13 can thus be understood as an indication that during the Late Antiquity phase 2 the heads of young sheep and goats were deposited (processed?) at other locations than their carcasses (cf. Maltby 1982, 86).<sup>31</sup> After all, certain obvious imbalances in the relative abundances were also indicated by the comparison between the number of finds of individual elements of the *appendicular* skeleton (Figs. 8.27–8.28).

The data on the “deficit” of young sheep and goat bones in the material from Late Antiquity phase 2 also has implications with regard to the difference between the two mortality profiles: the one based on the share of unfused bones (Tab. 8.9) and the one derived from the attrition sequences (Tab. 8.13). Since an important part of bones from the postcranial skeleton dated to Late Antiquity phase 2 are supposed to have been deposited outside the excavated area, the observed low contribution of unfused bones amongst the sheep/goat remains might be (heavily?) underestimated. If this is indeed so, then we may consider all thoughts unfounded as regards the increase in the average age of sheep and goats at culling with the beginning of the Late Antiquity phase 2. At the same time the analysis of tooth wear (Tab. 8.13) shows that in both Late Antiquity phases (i.e. 1 and 2) the majority of animals were culled/died before the age of one. The contribution of such young animals to the Late Antiquity phase 2 is statistically even more significant.

#### 8.4 THE SPATIAL DISTRIBUTION OF FINDS

At Tonovcov grad<sup>32</sup> by far the most archaeozoological finds originate from the area surrounding building 1 (i.e. 17,282 or 95.9 % of all excavated remains), while only 21 were discovered in the excavation of the water

<sup>30</sup> The material from Late Antiquity phase 1 does not show any statistically significant difference in the share of bones among all (i.e. bone and teeth) young animal finds when compared to the share of bones within all adult (three years or more) sheep and goat remains ( $\chi^2$  test:  $\chi^2 = 1.48$ ;  $p = 0.232$ ).

<sup>31</sup> Unfortunately, the weight of these results and their interpretations are reduced by the small numbers of finds. This holds true especially for the Late Antiquity phase 1.

<sup>32</sup> The several-year excavations at the site concerned an ecclesiastical complex, three additional buildings and a water cistern (Modrijan 2007).

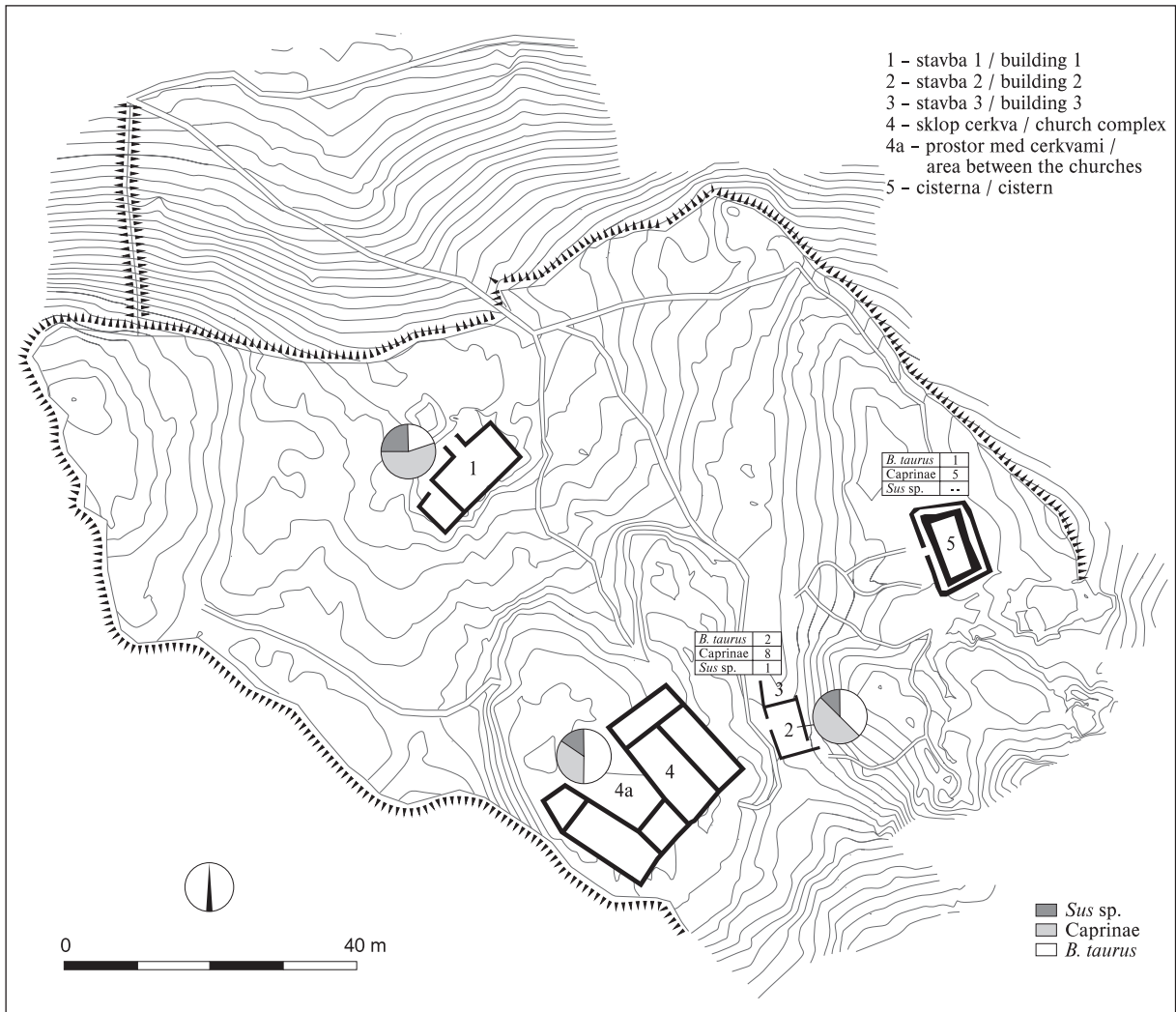

Sl. 8.10: Delež zastopanosti domačega goveda, drobnice in prašiča iz druge poznoantične poselitvene faze Tonovcovega gradu na prostoru med srednjo in južno cerkvijo, stavb 1–3 ter vodnega zbiralnika. Podatki o velikosti vzorcev so podani v prilogi 8.2.  
 Fig. 8.10: The share of cattle, sheep, goats and pigs from the Late Antiquity phase 2 at Tonovcov grad for the area between the central and the south churches, buildings 1–3 and the cistern. The data on the size of the samples is given in Appendix 8.2.

zastopan takson (območje stavbe 3; pril. 8.2: tab.C) oz. si je vodilno mesto delilo z drobnico (območje stavbe 1; pril. 8.2: tab. A).

V okviru interpretacije zgornjih rezultatov velja seveda opozoriti na skromnost vzorca s prostora med cerkvami (NISP = 121), čeprav so razlike med deležem zastopanosti goveda in drobnice med omenjenim vzorcem in ostalimi vzorci iz druge poznoantične faze sicer v vseh primerih nad mejo statistične značilnosti (test  $\chi^2$ :  $p < 0,05$ ). Arheološki podatki žal ne omogočajo nedvoumnega vpogleda v odnos med najdbami s prostora med cerkvami in samim cerkvenim kompleksom, saj je bila stratigrafska situacija na tem delu najdišča zelo kompleksna (glej Tonovcov grad. Naselbinski ostanki in interpretacija, pogl. 2.5.5). Je pa ugotovljen visok delež ostankov goveda vseeno omembe vreden. Lahko bi namreč kazal na specifičen status objekta, ki je v 6. stoletju

cistern.<sup>33</sup> Data on the number of finds of individual taxa in specific areas are given in Appendix 8.2. Due to the modest number of remains it is impossible to come up with a detailed analysis of the pattern of horizontal distribution of finds for most of the assemblages,<sup>34</sup> however the preliminary comparison between the shares of individual taxa within the assemblages – at least as far as the material from Late Antiquity phase 1 and the Early Medieval phase are concerned – revealed no significant

<sup>33</sup> Alongside the 16 taxonomically non-identified fragments the sample included a fragment of cattle horn core, a goat's scapula as well as a maxilla, a tooth ( $M_2$ ) and a distal part of a radius referable to caprines. All finds were dated into the Late Antiquity phase 2.

<sup>34</sup> Each assemblage includes animal remains found within the area of individual buildings (i.e. ecclesiastical complex, buildings 1-3, water cistern).

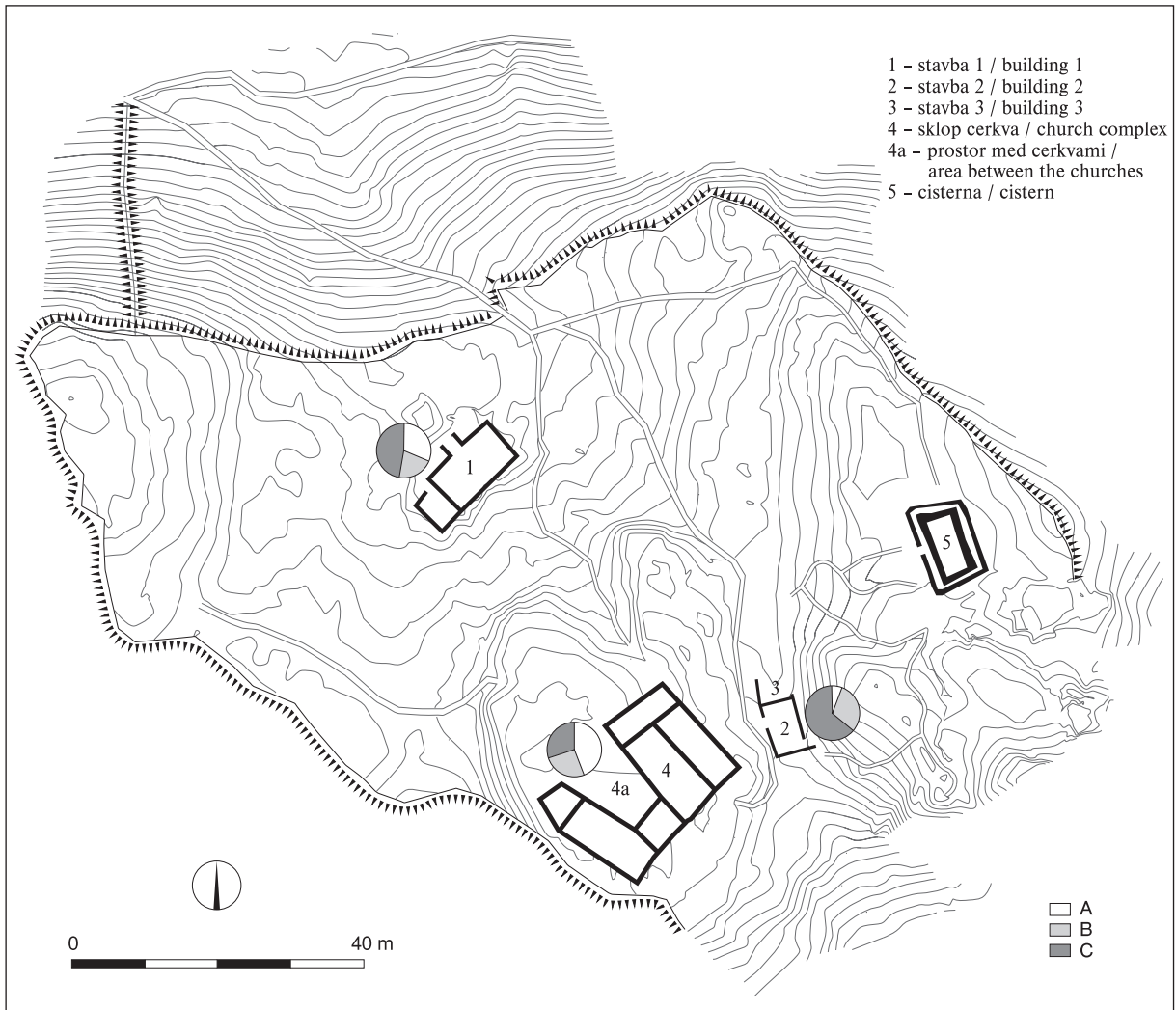

Sl. 8.11: Delež zastopanosti ostankov iz posamezne od treh kvalitetnih kategorij (tj. kategorija A, B in C) trupa domačega goveda za drugo poznoantično poselitveno fazo Tonovcovega gradu na prostoru med srednjo in južno cerkvijo ter stavb 1 in 2. Vzorec porazdelitve skeletnih elementov v omenjene kvalitetne kategorije je podan v pogl. 8.1.

Fig. 8.11: The share of the remains of each of the three qualitative categories (i.e. category A, B and C) of cattle carcass for the Late Antiquity phase 2 at Tonovcov grad for the area between the central and the south churches as well as buildings 1 and 2. The definition of individual qualitative categories is given in chapter 8.1.

stal na prostoru med cerkvama<sup>33</sup> (cf. Kobryn *et al.* 1984; Bartosiewicz 1998; Eryvnc 2004; MacKinnon 2004, 225). V tem smislu je še bolj poveden podatek o zastopanosti kosti in zob iz posamezne kvalitetne kategorije trupa goveda v treh favnističnih vzorcih iz druge poznoantične faze (sl. 8.11). Med ostanki s prostora med cerkvami namreč prevladujejo prav kosti najbolj mesnatih delov goveda (tj. kvalitetne kategorije A), česar ne izkazujeta ne

<sup>33</sup> Na prostoru med osrednjo in južno cerkvijo je bil odkrit v skalo vklesan izdolben prostor, ki je bil kasneje delno zasut in prekrit z več plastmi malte. Namen prostora ni popolnoma jasen, verjetno pa je bil izklesan kot vodni zbiralnik hkrati z izgradnjo prvih dveh cerkva konec 5. stoletja. Domnevno sredi 6. stoletja (tj. v poznoantični fazi 2) je bil objekt preurejen, s čimer se je spremenila tudi njegova namembnost (Modrijan 2007, 175 ss).

differences. A somewhat higher degree of heterogeneity is indicated by the spatial distribution of much more numerous cattle, caprine and pig finds originating from the Late Antiquity phase 2 (Fig. 8.10). The assemblage from the area between the central and the south churches stands out, for it is the only one (out of the five) in which cattle prevails (Appendix 8.2: Tab. D). In this sense the aforementioned sample reflects a similarity to the material from the Late Antiquity phase 1, in which cattle was either the best represented taxon (area of building 3; Appendix 8.2: Tab. C) or it shared the lead with caprines (area of building 1; Appendix 8.2: Tab. A).

During the interpretation of these results the paucity of the assemblage from the area between the central and the south churches (NISP = 121) should be noted, even though the differences between the contribution of cattle

sočasna vzorca z območja stavbe 1 oz. 2<sup>34</sup>, niti nobeden od vzorcev iz prve poznoantične oz. zgodnjerednjeveške faze poselitve Tonovcovega gradu.

Sicer praviloma skromni podatki o deležu še ne polnoma osificiranih kosti ter o stopnji obrabe žvekalne površine kočnikov najpomembnejših domačih živali za posamezne dele izkopnega polja ne izkazujejo omembe vredne heterogenosti v prostoru. To velja tudi za gradivo s prostora med cerkvami iz druge poznoantične faze, kjer skladno s splošno sliko najdišča prevladujejo ostanki več kot dve leti (marsikdaj tudi več kot tri leta) starih goved. Med desetimi izoliranimi kočniki drobnice sva tri pripisala enoletnim živalim, preostale pa praviloma nad dve leti starim ovcam oz. kozam. V kolikor gre omenjene najdbe dejansko povezovati s specifičnim statusom tega prostora (glej opombo št. 33), potem dajejo sicer pičli podatki o starosti živali ob zakolu/poginu zanimivo sliko o prehrani nekega segmenta prebivalcev, morda pa le obiskovalcev (romarjev?) Tonovcovega gradu. Ti naj bi tako uživali meso (predvsem govedino) istih živali kot (ostali) prebivalci naselbine in domnevno tudi nič pogostejše od stanovalcev stavb 1 in 2 posegali po mehkejšem ter zato verjetno tudi bolj cenjenem mesu telet, jagenj in/ali kozličev. Posebnost favnističnega gradiva s prostora med cerkvami je tako zgolj nadpovprečno dobra zastopanost skeletnih elementov iz najbolj kakovostnih anatomskih delov trupa goveda (tj. kategorije A; *sl. 8.11*), zaradi česar bi lahko sklepali na višji status nekaterih prebivalcev naselbine. Podobno razliko je na primeru rimskega vojaškega tabora pokazala primerjava jedilnikov poveljnika in njegovega moštva (Stokes 2000, 149), povedni pa so tudi podatki o jedilniku urbane elite na Apeninskem polotoku (MacKinnon 2004, 225).

#### 8.4.1 STAVBA 1

Med terenskim raziskovanjem je bila velika večina favnističnih najdb pobrana na območju stavbe 1. Gre za bivanjsko stavbo, ki je bila zgrajena in uporabljena v drugi fazi poznoantične poselitve.<sup>35</sup> Poleg površine same stavbe je bilo med izkopavanji na tem delu najdišča raziskanih še približno 400 m<sup>2</sup> njene okolice, kar omogoča analizo porazdelitve najdb v mikroprostoru. Rezultati kažejo koncentracijo ostankov pred vhomom v objekt ter vzdolž zunanje strani zidov 1, 4 in 5,<sup>36</sup> medtem ko se drugje pojavljajo le izjemoma (*sl. 8.12*). Pri tem

<sup>34</sup> Podatki za stavbo 3 in vodni zbiralnik v tej primerjavi niso bili upoštevani, saj je razpoložljivo število najdb preskromno.

<sup>35</sup> Do ponovne naselitve dela stavbe, ki je bila takrat že nekoliko porušena, je prišlo tudi v zgodnjerednjeveški fazi. Na širšem območju stavbe 1 so bili ohranjeni tudi ostanki starejše poselitve, datirane v prvo poznoantično fazo (glej Tonovcov grad. Naselbinski ostanki in interpretacija, pogl. 2.2, 2.3).

<sup>36</sup> Za identifikacijo posameznih zidov glej *sliko 8.12*.

as well as sheep/goat to the above assemblage and any of the remaining four assemblages from Late Antiquity phase 2 are all above the level of statistical significance ( $\chi^2$  test:  $p < 0.05$ ). Unfortunately, the archaeological data do not offer an unequivocal picture of the relationship between the finds from the area between the churches and the ecclesiastical complex itself, as the stratigraphic situation in this part of the site was extremely complex (see Tonovcov grad. Settlement remains and interpretation, chapter 2.5.5). However, the high proportion of cattle remains is worth mentioning, as this could point towards the specific status of the area between the central and south churches in the 6<sup>th</sup> century<sup>35</sup> (*cf.* Kobryń *et al.* 1984; Bartosiewicz 1998; Ervynck 2004; MacKinnon 2004, 225). In this context the data are even more informative as regards the representation of individual qualitative categories of the cattle carcass within each of the three samples dated to the Late Antiquity phase 2 (*Fig. 8.11*). Animal remains from the area between the churches are dominated by the bones from the cattle carcass richest in meat (i.e. qualitative category A), which appear neither in the samples from the same phase excavated in the area of buildings 1 and 2,<sup>36</sup> nor in the samples from the Late Antiquity phase 1 or the Early Medieval phase.

The generally poor data on molar wear as well as those regarding the relative abundance of unfused bones per location within the excavated area do not show a notable heterogeneity in space. This also applies to the material from the Late Antiquity phase 2 originating from the area between the central and the south churches, which is – in accordance with the general picture – dominated by the remains of cattle over two years (often well over 3 years) old. Amongst the ten isolated caprine molars, three were attributed to one year old animals, while the rest generally belonged to sheep and goats aged two years or more. In the event that the actual finds are to be associated with the specific status of this area (see footnote No. 35), then the (unfortunately scarce) data as regards the age of the animals at death offers an interesting outline of the diet of a segment of the population of (or perhaps visitors /pilgrims to) Tonovcov grad. Despite supposedly consuming the meat (especially in the case of beef) of the virtually very same animals as the residents in buildings 1 and 2, without showing a more pronounced preference for the more tender and therefore presumably also higher value meat

<sup>35</sup> In the area between the central and south church a space carved into stone and later partially covered with gravel and multiple layers of mortar was discovered. The function of the structure is unclear, however the most likely explanation is that it was carved as a water cistern at the time the first two churches were built (5<sup>th</sup> century). It is assumed that the structure was rebuilt in the middle of the 6<sup>th</sup> century (i.e. Late Antiquity phase 2), and at the time it also changed its function (Modrijan 2007, 175 ff).

<sup>36</sup> Due to the lack of finds the data for structure 3 and the water cistern were not taken into account in this comparison.



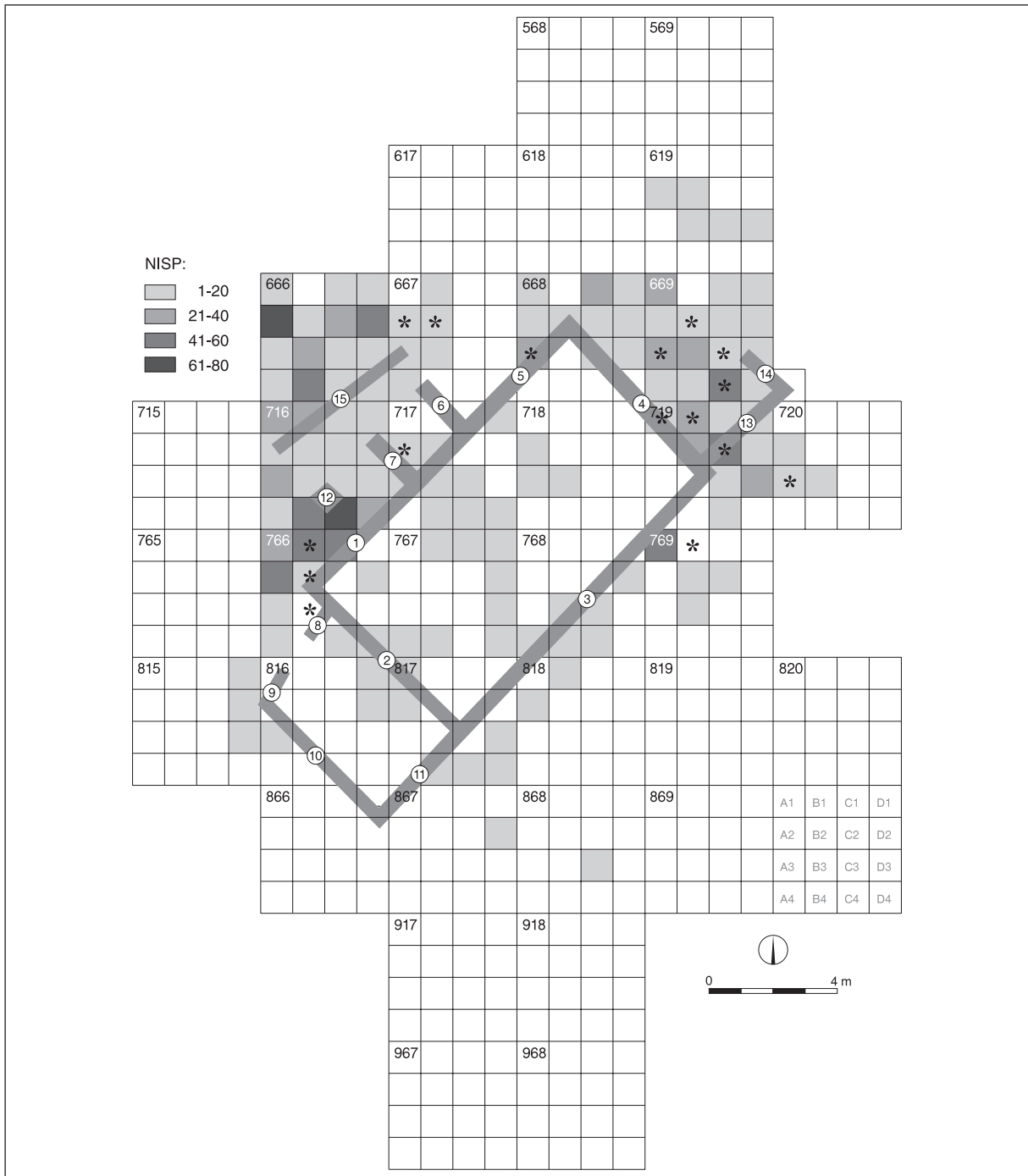

Sl. 8.12: Vzorec porazdelitve najdb domačega goveda, drobnice in prašiča iz druge poznoantične poselitvene faze Tonovcovega gradu na območju stavbe 1. Zvezda (\*) označuje mikrokvadrante, v katerih so bili najdeni ostanki zarodkov. Obkrožene številke predstavljajo oštevilčenje posameznih zidov.

Fig. 8.12: The distribution of finds of cattle, sheep, goats and pigs from the Late Antiquity phase 2 at Tonovcov grad for the area of building 1. The asterisk (\*) denotes the microquadrants in which embryonal remains were found. Encircled numbers represent numbering of the walls.

omembe vrednih razlik med posameznimi taksoni ni opaziti, prav tako tudi ne med obema poznoantičnima fazama.<sup>37</sup> Homogenost v prostoru (in času) izkazujejo

<sup>37</sup> Gradivo iz zgodnesrednjeveške faze v tej primerjavi ni bilo upoštevano, saj se najdbe pojavljajo le znotraj takrat sicer

of calves, lamb or kids, the food waste from the area between the central and the south churches does stand out with its above average representation of skeletal elements from the highest quality body parts (i.e. qualitative category A; Fig. 8.11), which could reflect the higher status

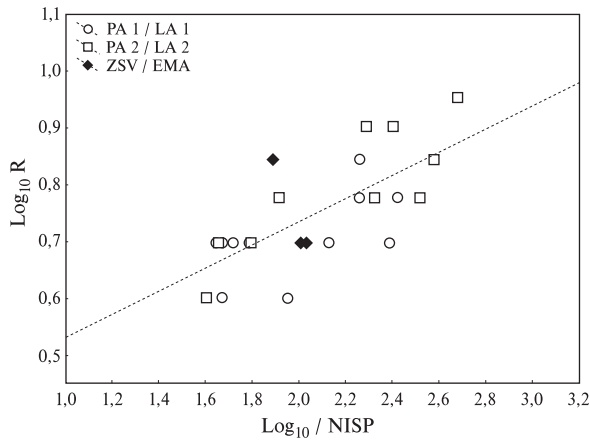

Sl. 8.13: Odnos med velikostjo vzorcev in njihovo vrstno pestrostjo za posamezne kvadrante s širšega območja stavbe 1 na Tonovcovem gradu. Upoštevani so bili le vzorci iz "bogatih" kvarantov, ki so vključevali vsaj 40 določljivih kosti in zob datiranih v eno od treh tukaj obravnavanih poselitvenih faz. Legenda: PA – poznoantična faza; ZSV – zgodnesrednjeveška faza.

Fig. 8.13: The relation between the sample size and the species diversity for individual quadrants from the broader area of building 1 at Tonovcov grad. Only samples from "rich" quadrants that included at least 40 taxonomically determined bones and teeth dated into one of the three settlement phases were taken into account. Legend: LA – Late Antiquity phase; EMA – Early Medieval phase.

tudi podatki o številu vrst med ostanki iz posameznega kvadranta, obteženi z velikostjo vzorcev (sl. 8.13).

V opisanem vzorcu porazdelitve se bolj od človekovih aktivnosti odraža izrazito razgiban teren. Kjer (je) hodno površino predstavlja(la) kar sama geološka osnova (npr. kv. 617, 618, 765, 815, 819, 866, 868), kulturne plasti niso ohranjene, zato so tu tudi najdbe izjemno maloštevilne. Severno in zahodno od objekta ter v ozkem pasu vzdolž njegovega vzhodnega zidu pa se je v skalni osnovi oblikovala depresija, ki so jo zapolnili mestoma tudi do 2 metra debeli sedimenti; tu (npr. kv. 666, 669, 716 ter deloma kv. 719, 769, 818 in 817) je bila izkopana večina vseh najdb.

Na zelo neravno osnovo je bila postavljena tudi sama stavba 1, kar je še posebej izrazito pri zidu 3. Ta namreč leži v osrednjem delu na skalni osnovi, ki se v notranjosti dviguje nad spodnji nivo temeljnih kamnov kar za 1,2 m (glej Tonovcov grad. Naselbinski ostanki in interpretacija, pogl. 2.3). Skala zavzema velik del osrednjega prostora stavbe 1, kar je zagotovo pomembno prispevalo k razmeroma skromnemu številu tam najdenih favnističnih najdb (N = 42 oz 2,2 %). To dodatno podkrepljuje podatek o šestkrat večji številčnosti zgodnesrednjeveških najdb na istem območju (N = 251), čeprav je vseh živalskih ostankov iz te faze štiriinpolkrat

že delno porušene stavbe 1 (glej Tonovcov grad. Naselbinski ostanki in interpretacija, pogl. 2.2, 2.3).

of that segment of the population within the settlement (cf. Stokes 2000, 149; MacKinnon 2004, 225).

#### 8.4.1 BUILDING 1

During the field research, the vast majority of the faunal finds were collected in the area of building 1. This was a dwelling that was built and used during the Late Antiquity phase 2.<sup>37</sup> In addition to the area of the building approximately 400 m<sup>2</sup> of its surroundings were investigated during the excavations of this part of the site, which allows for an analysis of the distribution of finds within a microspace. The results show a high concentration of remains in front of the building entrance and along the outer side of the walls 1, 4 and 5,<sup>38</sup> while elsewhere they are rather rare (Fig. 8.12). No noteworthy differences between the various taxa were observed, nor were there any major differences between Late Antiquity phases 1 and 2.<sup>39</sup> The homogeneity in space (and time) is also shown by the data on species richness of the mammal remains originating from individual squares, weighed by the sample size (Fig. 8.13).

This pattern of distribution is by all means a reflection of human activities; nevertheless, the major factor defining it must have been the highly varied terrain. In places where the walking surface was represented by the geological basis itself (e.g. sq. 617, 618, 765, 815, 819, 866, 868) the cultural layers were not preserved, therefore, finds were rare. To the north and west of the building and within a narrow strip along its east wall a depression formed in the rock basis, which was filled by a sediment up to 2 meters thick at some points; most of the excavated finds were discovered within this sediment (e.g. sq. 666, 669, 716, and partly sq. 719, 769, 818 and 817).

Building 1 was positioned on an extremely uneven base, which is best seen in the wall 3. Its central part is located on live rock that rises as much as 1.2 m above the lower level of the interior cornerstones (see Tonovcov grad. Settlement remains and interpretation, chapter 2.3). The rock takes up a large part of the central area within building 1, which certainly contributed to the relatively small number of animal remains discovered there (N = 42 or 2.2 %). This is further emphasized by the data on the

<sup>37</sup> Part of the building that was already slightly ruined at the time was repopulated during the Early Medieval phase. Remains of the older settlement phase (i.e. Late Antiquity phase 1) were also discovered in the broader area of structure 1 (see Tonovcov grad. Settlement remains and interpretation, chapters 2.2, 2.3).

<sup>38</sup> For the identification of individual walls see figure 8.13.

<sup>39</sup> In this comparison the material from Early Medieval phase was not taken into account, for the finds only appear within the (at the time) already partially ruined structure 1 (see Tonovcov grad. Settlement remains and interpretation, chapters 2.2, 2.3).

Tab. 8.14: Številčnost ostankov iz posamezne od treh kvalitetnih kategorij (tj. kategorije A, B in C) trupa domačega goveda, drobnice in prašiča v okviru gradiva iz druge poznoantične poselitvene faze Tonovcovega gradu na območjih glavnega prostora stavbe 1 in njenega prizidka. Vzorec porazdelitve skeletnih elementov v omenjene kvalitetne kategorije je podan v pogl. 8.1.

Tab. 8.14: The numbers of finds of each of the three qualitative categories (i.e. categories A, B and C) of cattle, sheep/goat and pig carcasses, within the frame of the material from the Late Antiquity phase 2 of Tonovcov grad, originating from the areas of the main room of building 1 and its extension. The definition of individual qualitative categories is given in chapter 8.1.

Kategorija / Category	<i>B. taurus</i>	Caprinae	<i>Sus sp.</i>	Σ
Glavni prostor / Main room:				
A	4	8	3	15
B	3	7	–	10
C	6	21	3	30
Σ	13	36	6	55
Prizidek / Extension:				
A	–	2	–	2
B	–	2	–	2
C	5	10	2	17
Σ	5	14	2	21

manj od tistih iz druge poznoantične faze (*pril.* 8.2: *tab.* A). Najdbe iz najmlajše od treh tukaj obravnavanih faz so namreč ležale v plasti mehke, kulturne zemlje, ki je ostanek ponovne uporabe delno že porušenega objekta. Pri tem se navedena plast ni deponirala neposredno na skalno osnovo kot pri najdbah iz druge poznoantične faze, marveč na do 60 cm debelo plast žganine oz. ostankov s sten odpadlega ometa (glej Tonovcov grad. Naselbinski ostanki in interpretacija, pogl. 2.2).

V okviru analize vzorca porazdelitve živalskih ostankov na širšem območju stavbe 1 velja opozoriti še na rezultate primerjave med gradivom iz glavnega prostora in tistim iz prizidka.<sup>38</sup> Omembe vrednih razlik v deležu zastopanosti posameznih taksonov omenjena primerjava ni pokazala (*tab.* 8.14), kar je potrdilo tudi statistično testiranje (test  $\chi^2$ :  $\chi^2 = 0,683$ ;  $p > 0,05$ ). Zanimivo pa je, da vzorec iz prizidka odstopa po večinskem deležu zastopanosti kosti iz najmanj mesnatih delov trupa (tj. kvalitetne kategorije C). Res je, da je število najdb pičlo, a podobno izrazita prevlada zob, prstnic, dlančnic/stopalnic ter zapestnih/nartnih kosti ni bila ugotovljena pri nobenem od ostalih kvadrantov s podobno majhnim številom najdb (tj.  $20 < \text{NISP} < 60$ ; *sl.* 8.14).<sup>39</sup> Celo več. Verjetnost, da bi lahko naleteli na vzorec s tako izrazito

six times greater numbers of early medieval finds in the same area ( $N = 251$ ), even though there are four and a half times fewer animal remains from the Early Medieval phase altogether, when compared to those from Late Antiquity phase 2 (*Appendix* 8.2: *Tab.* A). This is because the finds dated to the latest of the three settlement phases collected within the area of building 1 lay in stacked layer of soft, strong cultural soil, which formed when the then already partially demolished building was being reused. This layer was not deposited directly on the rock base, as was the case with the finds from the Late Antiquity phase 2, but on an up to 60 cm thick layer of burnt plaster remains (see Tonovcov grad. Settlement remains and interpretation, chapter 2.2).

In the analysis of the spatial distribution of animal remains in the broader area of building 1 attention should be drawn to the results from the comparison between the material from the main room and that from the extension.<sup>40</sup> No noteworthy differences in the representation of individual taxa were observed in this comparison (*Tab.* 8.14) which was additionally confirmed by the statistical testing ( $\chi^2 = 0.683$ ,  $p > 0.05$ ). It is interesting, though, that the assemblage from the extension displayed a much greater share of bones from the least meaty parts of cattle, sheep/goat and pig carcasses (i.e. qualitative category C). It is true that the number of finds is scarce, but a similar strong dominance of teeth, phalanges, metacarpals, metatarsals, carpals and tarsals has not been found in any of the other squares with a similarly low number of finds (i.e.  $20 < \text{NISP} < 60$ ; *Fig.* 8.14).<sup>41</sup> Moreover, in the event that

<sup>38</sup> Upoštevala sva le najdbe iz druge poznoantične faze, ko sta bila edinkrat v uporabi oba dela stavbe 1.

<sup>39</sup> V tem smislu predstavlja edino izjemo gradivo iz kvadranta 766, kjer prav tako močno prevladujejo ostanki najmanj mesnatih delov trupa. Vendar pa je v zvezi s tem treba dodati, da gre visok delež najdb iz kvalitetne kategorije C v tem primeru predvsem na račun ostankov drobnice. Med kostnimi najdbami večjega goveda je namreč tretjina primerkov iz najbolj kakovostnih delov živali, kar pa vsekakor odstopa od vzorca iz prizidka (*tab.* 8.14).

<sup>40</sup> We only took into account the finds from Late Antiquity phase 2, when both parts of the building were in use.

<sup>41</sup> In this sense the only exception is represented by the

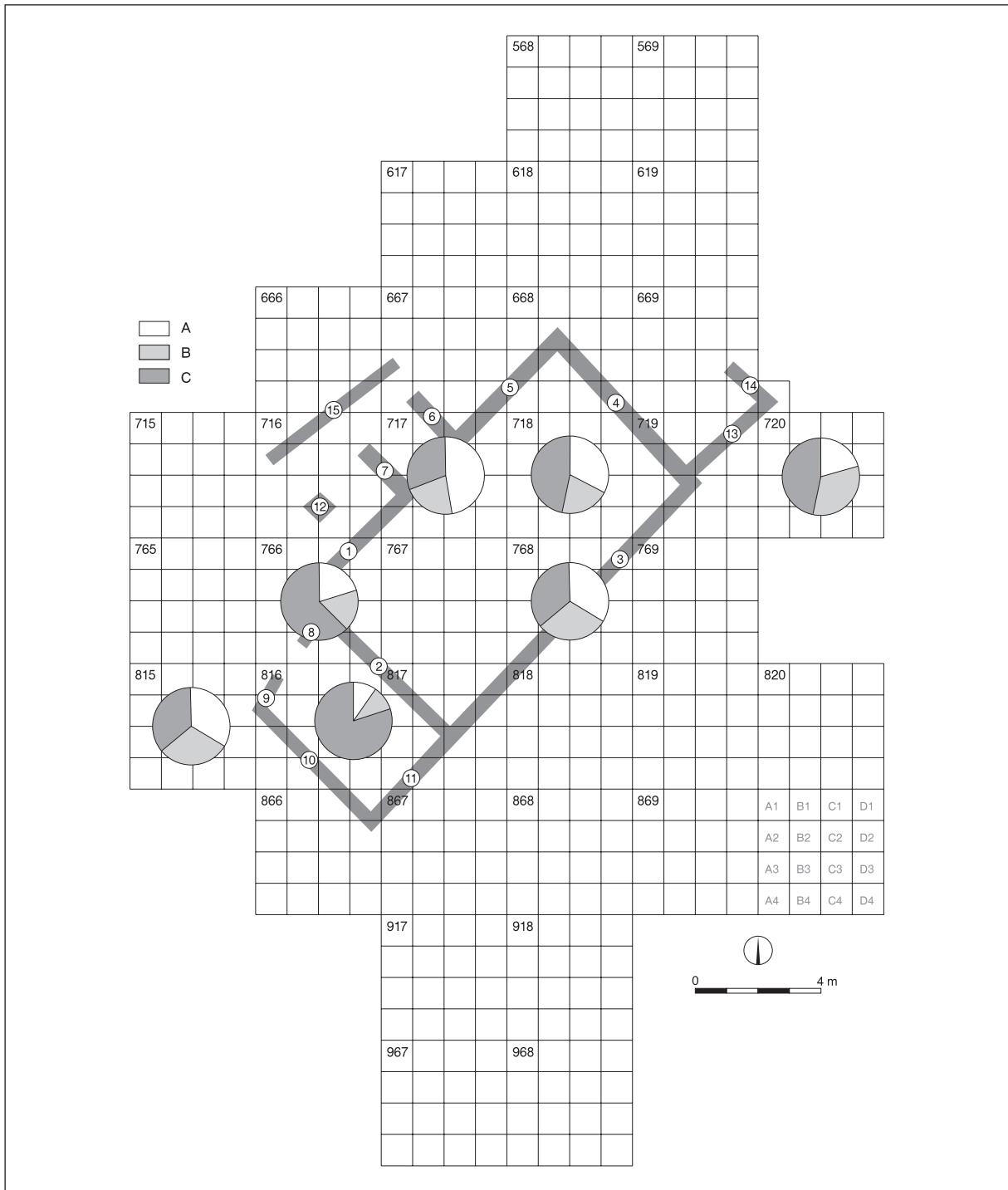

Sl. 8.14: Delež zastopanosti ostankov iz posamezne od treh kvalitativnih kategorij (tj. kategorija A, B in C) trupa domačega goveda, drobnice in prašiča za drugo poznoantično poseljeno fazo Tonovcovega gradu za stavbo 1, njegov prizidek in bližnje okolico; podatki so prikazani le za kvadrante, znotraj katerih je bilo najdenih med 20 in 60 določljivih kosti in zob. Vzorec porazdelitve skeletnih elementov v kvalitativne kategorije A, B in C je podan v pogl. 8.1.

Fig. 8.14: The share of the remains of each of the three qualitative categories (i.e. category A, B and C) of the carcass of cattle, sheep, goats and pigs for the Late Antiquity phase 2 at Tonovcov grad for building 1, its extension and its near vicinity. The data is shown only for quadrants within which at least 20 taxonomically determined bones and teeth were found ( $NISP_{max} = 60$ ). The division of skeletal elements into qualitative categories A, B and C is shown in chapter 8.1.

prevlado ostankov iz najmanj mesnatih delov trupa tudi v primeru, ko tovrstnih razlik med izhodiščnim naborem najdb v prizidku in njegovi bližnji okolici sploh ni bilo, je manjša od petih odstotkov (test  $\chi^2$ :  $p < 0,05$ ). Da bi bilo odstopanje vzorca iz prizidka zgolj naključno, se torej ne zdi verjetno.

Pri poskusu interpretacije zgornjih ugotovitev sva upoštevala dejstvo, da je bila kvaliteta gradnje prizidka razmeroma slaba. Njegovi zidovi namreč niso bili temeljeni tako globoko kot zidovi glavnega prostora, prav tako pa tudi niso bili ometani. Poleg tega je večino že tako skromno odmerjenega uporabnega prostora zavezala skala, tako da je bilo nekaj za bivanje primernega ravnega prostora le ob zidovih 8 in 9; v vogal zidov 9 in 10 je bilo postavljeno tudi ognjišče (glej Tonovcov grad. Naselbinski ostanki in interpretacija, pogl. 2.3). Navedeni podatki kažejo, da je prizidek sicer lahko bil uporabljen kot bivalni prostor (prisotnost ognjišča!), da pa je v njem najverjetneje prebivala oseba nižjega statusa, hlapec. Skoraj izključna prisotnost ostankov iz najmanj kvalitetnih delov trupa v sicer skromnem vzorcu se zdi tako razumljiva in na neki način predstavlja antitezo slike, ki jo kažejo favnistične najdbe z območja domnevne shrambe duhovščine na območju med srednjo in južno cerkvijo (sl. 8.11).

## 8.5 ANALIZA VELIKOSTI

Mere kolikor toliko ohranjenih sesalskih ostankov s Tonovcovega gradu so podane v *prilogi 8.1*. Žal je razpoložljivih podatkov pri večini vrst le peščica, tako da poglobljenih metričnih analiz ni bilo mogoče izvesti. Izjemo predstavljajo domače govedo, drobnica (predvsem ovca), prašič ter deloma konj, kjer sva ugotovila obstoj morebitnih trendov spreminjanja velikosti skozi čas in med regijami. Analize temeljijo na primerjavi standardiziranih metričnih podatkov dolgih kosti, čeprav sva upoštevala tudi mere petnic in/ali skočnic (glej pogl. 8.1). Vsaka kost je bila zastopana s po eno meritvijo, ki je bila vedno nedolžinska; pri kopitarjih so namreč slednje primernejše za oceno mase živali od dolžinskih mer (Scott 1990).

### 8.5.1 DOMAČE GOVEDO

Metrične študije ostankov domačega goveda v Srednji Evropi so pokazale, da se je z začetkom obdobja preseljevanja ljudstev velika "rimska" oblika (pasma?) goveda na tem prostoru postopoma izgubila. Govedoreja je, podobno kot že pred prihodom Rimljanov, v pozni antiki in ponovno zgodnjem srednjem veku temeljila predvsem na primitivnih lokalnih formah (Bökönyi 1974, 134). Navedeni proces, ki je imel seveda za posledico tudi upad povprečne velikosti živali v takratnih

originally no differences in the carcass parts consumed by the inhabitants of the main room and those dwelling in its extension existed, the chances that we would observe such a pronounced differences in food waste composition between the two areas as those shown in *table 8.14* and *figure 8.14* are less than five percent ( $\chi^2$  test:  $p < 0.05$ ).

In an attempt to interpret these considerations we took into account the fact that the quality of construction the extension was relatively poor. Its walls were not founded as deeply as the walls of the main room, and they were not plastered either. In addition, the majority of the already modest usable space was occupied by a rock, thus the only levelled area suitable for habitation could be found along the walls 8 and 9, where the fireplace was located (in the corner of walls 9 and 10; see Tonovcov grad. Settlement remains and interpretation, chapter 2.3). These data suggest that the extension could have been used as a living quarters (note the presence of the fireplace), but that it was most probably inhabited by a person of a lower status, a servant. The almost exclusive presence of poorest quality meat remains in the (unfortunately modest) sample seems thus understandable and in a way represents an antithesis to the image shown by the faunal remains found in the area of the assumed clergy larder in the area between the central and the south churches (*Fig. 8.11*).

## 8.5 SIZE ANALYSIS

The measurements of the sufficiently preserved mammalian remains from Tonovcov grad are shown in *Appendix 8.1*. Unfortunately, there is only a smidgen of available data for most species, so no in-depth metric analysis could be performed. An exception is represented by cattle, caprines (mainly sheep), pigs and to a certain extent horses in which cases we tried to check for the existence of any trends of diachronic size changes between regions. The analysis is based on the comparison between standardized measurements of long bones, even though measurements of calcaneus and/or talus bones were also taken into consideration (see chapter 8.1). In the analysis each bone was represented by a single measurement. This was always a breadth measurement (e.g. smallest breadth of the diaphysis, breadth of the proximal/distal epiphysis), as in ungulates they are more suitable for assessing the weight of the animal than lengths (Scott 1990).

material from square 766, in which the remains from the least meat-rich parts of the carcass dominate. However, it has to be said that the high share of finds from the qualitative category C is mainly due to a large number of caprine feet bones. Among cattle finds one third is represented by bones from the meatiest parts of the carcass, which certainly differs from the picture observed in the case of the sample collected within the extension (*Tab. 8.14*).

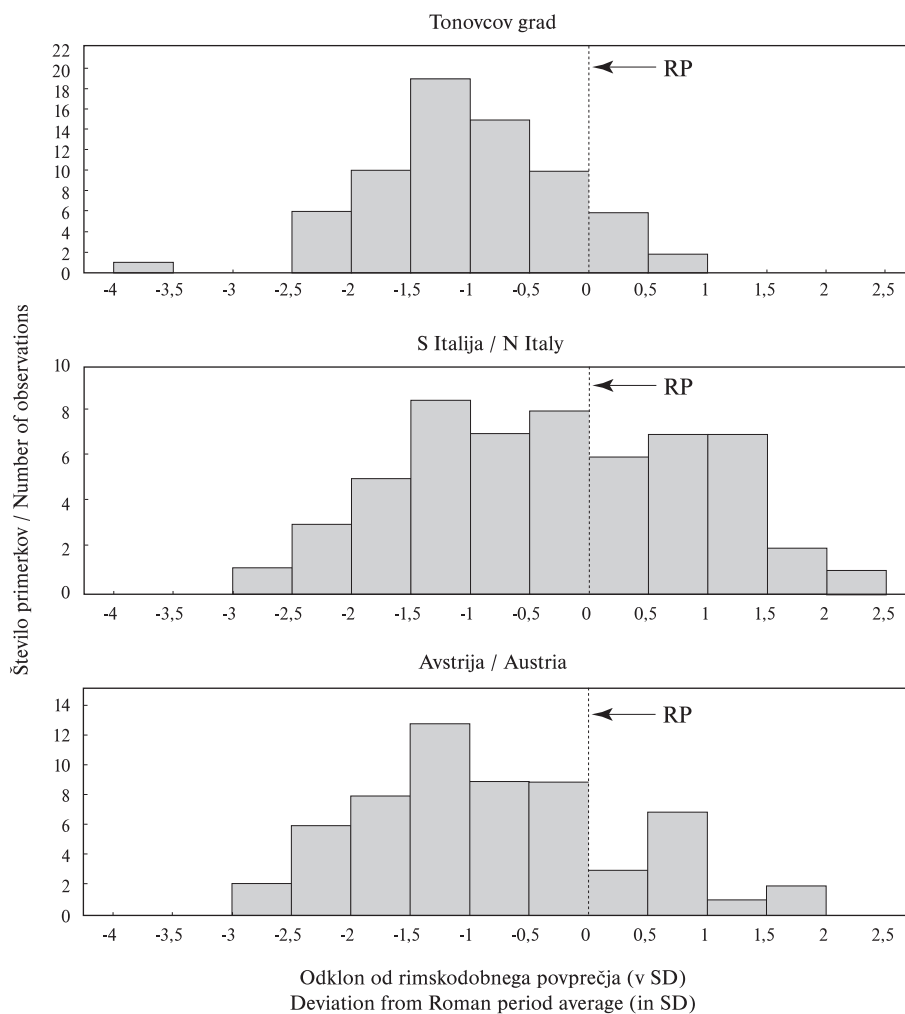

Sl. 8.15: Porazdelitev standardiziranih dimenzij dolgih kosti (nadlahtnica, koželjnica, dlančnica, golenica, stopalnica) ter petnic in skočnic domačega goveda s Tonovcovega gradu ter z več sočasnih najdišč severne Italije in Avstrije. Vsak skeletni element je zastopan le s po eno dimenzijo. Postopek standardiziranja dimenzij je podan v pogl. 8.1. Legenda: RP – rimskodobno povprečje, izračunano na osnovi govejih ostankov iz rimskega mesta Tăc/Gorsium (Madžarska; Bökönyi 1984). Seznam najdišč S Italije: Invillino (Stork, von den Driesch 1987); Monte Barro (Baker 1991); Videm/Udine: grad (Riedel 1993b); Verona: skupek VR-I (Riedel 1994a). Seznam najdišč Avstrije: Kappele (Pucher 1993); Teriola (Pucher 2003); Sveta Hema/Hemmaberg (Forstenpointner *et al.* 2002); Drösing (Riedel 2007).

Fig. 8.15: Distribution of standardised metric datas of cattle long bones (humerus, radius, metacarpals, tibiae, metatarsals) as well as calcanei and astragali from Tonovcov grad and from a number of contemporary sites in North Italy and Austria. Each skeletal element is represented by a single dimension. The procedure for standardising the metric data is given in chap. 7.1. Legend: RP – Roman Period average, calculated on the basis of cattle remains from the Roman town Tăc/Gorsium (Hungary; Bökönyi 1984). The list of sites in N Italy: Invillino (Stork, von den Driesch 1987); Monte Barro (Baker 1991); Udine: castle (Riedel 1993b); Verona: complex VR-I (Riedel 1994a). List of sites in Austria: Kappele (Pucher 1993); Teriola (Pucher 2003); Hemmaberg (Forstenpointner *et al.* 2002); Drösing (Riedel 2007).

čredah, je najprej zajel bolj oddaljene province cesarstva (Bökönyi 1974, 134), medtem ko ga je na nižinskih območjih severne Italije zaznati šele z nastopom zgodnjega srednjega veka (Riedel 1979, 138 s; 1986, 85).

Primerjava standardiziranih metričnih podatkov ( $\approx$  velikosti) za kosti domačega goveda s Tonovcovega gradu ter z več sočasnih najdišč severne Italije in Avstrije je dala rezultate, ki zgornjo ugotovitev v celoti podpirajo (sl. 8.15). Navedeni trije vzorci se namreč med seboj dejansko razlikujejo, pri čemer razlika presega mejo

### 8.5.1 CATTLE

Metric analyses of cattle remains from Central European sites have shown that with the beginning of the Migration period the large "Roman" form (breed?) of cattle gradually disappeared from this region. Similarly to the period before the arrival of the Romans, cattle husbandry in Late Antiquity and the Early Middle Ages was once again based primarily on the primitive local forms (Bökönyi 1974, 134). This process, which of course

statistične značilnosti (Kruskal-Wallisov ANOVA-test:  $H [2; N = 185] = 11,18; p = 0,004$ ). Izstopa predvsem veliko severnoitalijansko govedo,<sup>40</sup> medtem ko statistično značilnih razlik med razpoložljivimi podatki za vzorec s Tonovcovega gradu ter tistimi z avstrijskih najdišč ni (Mann-Whitneyjev U-test:  $U = 1944,5; Z = -0,75; p = 0,455$ ). Pri tem je povedno, da se povprečna vrednost standardiziranih metričnih podatkov za severnoitalijansko poznoantično govedo v splošnem ujema s povprečno vrednostjo rimskodobnih živali iz mesta TÁC/*Gorsium*<sup>41</sup> (Bökönyi 1984), kar izpričuje pomembno zastopanost velikega "rimskega" goveda na območju ravninske severne Italije še globoko v obdobju pozne antike (cf. Riedel 1993b, 101; 1994a, 18), morda celo do začetnih faz zgodnjega srednjega veka (cf. Riedel 1979, 108).

Standardizirani metrični podatki za govedo s Tonovcovega gradu in Avstrije so, nasprotno, večinoma porazdeljeni levo od navpičnice, ki označuje povprečno vrednost za referenčni vzorec iz mesta TÁC/*Gorsium* (sl. 8.15). Govedo s Tonovcovega gradu je bilo v povprečju statistično značilno manjše tudi od goveda iz živalskimi ostanki bogatega rimskodobnega najdišča Ribnica na Dolenjskem/*Romula* (Mann-Whitneyjev U-test:  $U = 3772,0; Z = -5,05; p = 0,000$ ), kar le še dodatno potrjuje progresivno povečevanje vloge primitivnega lokalnega goveda na Slovenskem v obdobju po koncu 4. stoletja. Višino ob vihru sva za gradivo s Tonovcovega gradu lahko izračunala le v primeru dlančnice<sup>42</sup> iz vzorca št. 414 (kv: 816; mkv: B4; druga poznoantična faza) in stopalnice<sup>43</sup> iz vzorca št. 2038 (kv./mkv. 668/D3, 669/D4; prva poznoantična faza). Sicer izolirana podatka sta skladna z zgornjimi ugotovitvami, saj sta oba mnogo bližje povprečnim vrednostim železnodobnih primerkov goveda iz Stične kot pa rimskodobnim iz Ribnice na Dolenjskem/*Romule* (tab. 8.15).

V nadaljevanju sva vzorejala velikost primerkov s Tonovcovega gradu in tistih s poznoantičnih najdišč Ajdovski Gradec nad Vranjem (Bartosiewicz, Choyke 1985) in Tinje nad Loko pri Žusmu (Turk 2000, Tab. 1) ter ugotovila odsotnost statistično značilnih razlik (Mann-Whitneyjev U-test:  $U = 279,0; Z = -1,40; p = 0,160$  oz.  $U = 323,0; Z = 0,32; p = 0,745$ ). Podobnost med navedenimi vzorci izpričujejo tudi sicer maloštevilne ocene višine živali ob vihru (tab. 8.15). Izginotje velikega "rimskega" goveda je bilo, kot kaže, na celotnem območju današnje Slovenije bolj ali manj sočasno.

<sup>40</sup> Razlika v razpoložljivih standardiziranih metričnih podatkih domačega goveda med Tonovcovim gradom in severnoitalijanskimi najdišči je statistično značilna (Mann-Whitneyjev U-test:  $U = 1229,0; Z = -3,36; p = 0,001$ ).

<sup>41</sup> Navedeno gradivo sva sicer uporabila kot referenčni vzorec pri postopku standardiziranja metričnih podatkov goved s posameznih poznoantičnih najdišč (glej pogl. 8.1).

<sup>42</sup> Na osnovi vrednosti indeksa vitkosti (tj. 19,83) in Nobisovega indeksa (tj. 33,06) sva primerek pripisala samici.

<sup>43</sup> Na osnovi vrednosti indeksa vitkosti (tj. 12,33) in Nobisovega indeksa (tj. 20,71) sva primerek pripisala samcu.

also resulted in the decline in the average withers height of animals, first occurred in the more remote provinces of the Empire (Bökönyi 1974, 134), while it took until the Early Medieval period to hit the lowland areas of northern Italy (Riedel 1979, 138 f; 1986, 85).

The comparison between the standardized measurements ( $\approx$  size) for cattle bones from Tonovcov grad and a number of contemporary sites in northern Italy and Austria offered results that fully support these findings (Fig. 8.15). The three samples actually differ from each other, at which the difference exceeds the level of statistical significance (Kruskal-Wallis ANOVA test:  $H [2, N = 185] = 11,18; p = 0,004$ ). The large north Italian cattle stand out,<sup>42</sup> while there are no statistically significant differences to be observed between the available data for the sample from Tonovcov grad and those from the Austrian sites (Mann-Whitney U test:  $U = 1944,5; Z = -0,75; p = 0,455$ ). The average value of the standardized measurements for Late Antique cattle from north Italy in general falls within the range of the average value of animals from the Roman town of TÁC/*Gorsium*<sup>43</sup> (Bökönyi 1984), testifying the significant representation of large "Roman" cattle in the North Italian plains deep into the Late Antique period (cf. Riedel 1993b, 101; 1994, 18), perhaps even as late as the initial stages of the Early Middle Ages (cf. Riedel 1979, 108).

Contrary to what has been observed in north Italian material the standardized measurements for cattle from Tonovcov grad and Austria are mainly distributed to the left of the vertical that indicates the average value for the reference assemblage collected at TÁC/*Gorsium* (Fig. 8.15). As a matter of fact, the cattle from Tonovcov grad was statistically significantly smaller also relative to conspecific animals from Roman period sites in present-day Slovenia (Mann-Whitney U test:  $U = 3772,0; Z = -5,05; p = 0,000$ ; own unpublished data), which further corroborates the progressive increase in the role of primitive local cattle of small stature in the area of Southeastern Alps in the post 4<sup>th</sup> century period. As far as the material from Tonovcov grad is concerned, the withers height could be calculated only for the metacarpal<sup>44</sup> from sample No. 414 (sq./msq.: 816/B4; Late Antiquity phase 2) and the metatarsal<sup>45</sup> from sample No. 2038 (sq./msq.: 668/D3,

<sup>42</sup> The difference in the standardized measurements of cattle originating from Tonovcov grad relative to those from north Italian sites is statistically significant (Mann-Whitney U test:  $U = 1229,0; Z = -3,36; p = 0,001$ ).

<sup>43</sup> The material from this site has already been used as the reference sample at the procedure of standardizing measurements for cattle from individual Late Antique sites (see chapter 8.1).

<sup>44</sup> On the basis of the estimate of the slenderness index (19.83) and the Nobis' index (33.06) the specimen was attributed to a female.

<sup>45</sup> On the basis of the estimate of the slenderness index (12.33) and the Nobis' index (20.71) the specimen was attributed to a male.

Tab. 8.15: Ocene višine ob vihru za domače govedo s Tonovcovega gradu, Stične (železna doba; Bökönyi 1994, Tab. 6), Ribnice na Dolenjskem/Romula (rimsko obdobje; neobjavljeni lastni podatki), Ajdovskega Gradca nad Vranjem (Bartosiewicz, Choyke 1985, Tab. 6) in Pristave na Bledu (Toškan, Dirjec 2008, 141). Višina ob vihru je izračunana na osnovi dimenzij dlančnic oz. stopalnic s pomočjo Matolcsijevih koeficientov (Matolcsi 1970). Legenda: Me – mediana; N – velikost vzorca; Min.–Max. – razpon vrednosti. Vse vrednosti so v cm.

Tab. 8.15: The estimate of the withers height for cattle from Tonovcov grad, Stična (Iron Age; Bökönyi 1994, Tab. 6), Ribnica na Dolenjskem/Romula (Roman period; unpublished personal data), Ajdovski Gradec above Vranje (Bartosiewicz, Choyke 1985, Tab. 6) and Pristava at Bled (Toškan, Dirjec 2008, 141). The withers height is calculated on the basis of the dimensions of the metacarpals or metatarsals with the aid of Matolcsi's coefficients (Matolcsi 1970). Abbreviations: Me – median; N – sample size; Min.–Max. – range. All values are in cm.

Trend povečevanja povprečne velikosti domačega goveda s prihodom Rimljanov ter naknaden upad v pozni antiki in zgodnjem srednjem veku je še očitneje izpričan na *sliki 8.16*. Ta prikazuje vrednosti prve glavne komponente (PC1 scores), izračunane na podlagi korelacijske matrike metričnih podatkov treh dimenzij<sup>44</sup> skočnic iz več prazgodovinskih, rimskodobnih, poznoantičnih in zgodnesrednjeveških najdišč v širši regiji. Ker prva glavna komponenta v okviru analize glavnih komponent (PCA) po definiciji opiše najvišji delež variance<sup>45</sup> osnovne množice podatkov, jo je mogoče razumeti kot vektor velikosti oz. nosilko velikostne informacije<sup>46</sup> (Lemen 1983). Drugače povedano: razlike v vrednostih prve glavne komponente med posameznimi najdišči/obdobji je, glede na navedeno zgoraj, utemeljeno interpretirati kot razlike v velikosti živali. Toliko bolj, ker so pri govedu dimenzije skočnic v veliki korelaciji z maso samih živali (*cf.* Bartosiewicz 1984).

Testiranje razlik v vrednostih PC1 med posameznimi vzorci s *slike 8.16* je pokazalo, da te presegajo mejo statistične značilnosti (Kruskal-Wallis ANOVA-test:  $H [3, 109] = 22,51; p = 0,000$ ). Seveda gre navedeno heterogenost pripisati predvsem izrazito višjemu povprečju rimskodobnih goved, k čemur je prispevala prisotnost ostankov velikih "rimskih" form. Po drugi strani razlik med gradivom s Tonovcovega gradu in tistim z drugih poznoantičnih in zgodnesrednjeveških najdišč v širši regiji ni, tako kot tudi ne med podatki

<sup>44</sup> Gre za največjo dolžino na medialni strani (GLM *sensu* von den Driesch 1976), širino na lateralni strani (DI) ter širino distalnega dela (Bd). Pri vseh treh dimenzijah so bili metrični podatki porazdeljeni normalno (Shapiro-Wilkov W-test:  $p > 0,05$ ).

<sup>45</sup> Delež variance, ki ga v obravnavanem primeru opiše posamezna od prvih dveh glavnih komponent: PC 1 (88,7 %), PC 2 (7,4 %) in PC 3 (3,9 %).

<sup>46</sup> Znano namreč je, da nam v morfometriji največji delež variance praviloma razloži prav velikost.

Najdišče Site	Metacarpus	Metatarsus
	Me (N) Min.–Max.	Me (N) Min.–Max.
Tonovcov grad	112,1	116,3
Stična	108,1 (4) 98,9–113,7	111,3 (4) 102,3–116,0
Romula	122,4 (35) 108,8–134,1	124,25 (20) 112,2–131,9
Ajdovski gradec	110,6 & 116,1	–
Pristava	–	108,2

669/D4; Late Antiquity phase 1). The two data, though isolated, are consistent with the above findings, since both are much closer to the average values of Iron Age animals from Stična than to their Roman period counterparts (e.g. Ribnica/Romula; Tab. 8.15).

Next we compared the sizes of the specimens from Tonovcov grad and those from the Late Antique sites at Ajdovski Gradec above Vranje (Choyke and Bartosiewicz 1985) and Tinje above Loka pri Žusmu (Turk 2000, Tab. 1) and noted the absence of statistically significant differences (Mann-Whitney U test:  $U = 279,0; Z = -1,40; p = 0,160$  and  $U = 323,0; Z = 0,32; p = 0,745$ , respectively). The similarity between these samples is also testified by the few calculable withers height estimates (Tab. 8.15). It thus seems that the large "Roman" cattle disappeared throughout the territory of present-day Slovenia more or less simultaneously.

The trend of increasing average cattle size with the arrival of the Romans and the subsequent decline observed in Late Antiquity and the Early Medieval period is even more evidently shown by the results of the Principal Component Analysis (PCA; Fig. 8.16). The latter was calculated on the correlation matrix of three measurements of cattle astragali<sup>46</sup> from numerous prehistoric, Roman period, Late Antique and Early Medieval sites in the broader region. Since the first principal component by definition accounts for the highest share of the total variance<sup>47</sup> of the initial data set, it can be understood as a size vector or a carrier of size information<sup>48</sup> (Lemen 1983). In other words, the differences in the first principal component scores between the individual sites/periods can be reasonably interpreted as differences in animal sizes. This is all the more so as it is known for the

<sup>46</sup> This includes the greatest length on the medial side (GLM *sensu* von den Driesch 1976), the depth on the lateral side (DI) and the greatest breadth of the distal part (Bd). The measurements conformed to the normal distribution in all three the dimensions (Shapiro-Wilk W test:  $p > 0,05$ ).

<sup>47</sup> The shares of the total variance accounted for by the first three principal components equal 88.7 % (PC 1), 7.4 % (PC 2) and 3.9 % (PC 3).

<sup>48</sup> In morphometry the highest share of variance is as a rule linkable to size.



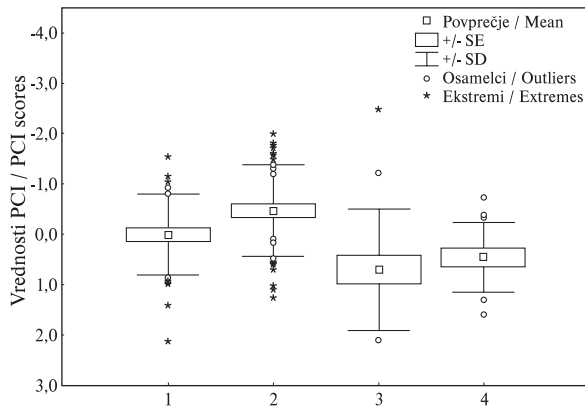

Sl. 8.16: Diagram vrednosti prve glavne komponente (PC 1 scores), izračunane na osnovi korelacijske matrike metričnih podatkov treh dimenzij skočnic s Tonovcovega gradu (vzorec 3) ter z več prazgodovinskih (vzorec 1), rimskodobnih (vzorec 2) in poznoantičnih oz. zgodnesrednjeveških (vzorec 4) najdišč v širši regiji. Zaradi negativnega predznaka vseh treh faktorskih uteži (*factor loadings*) izkazujejo večje skočnice nižje vrednosti prve glavne komponente napram tistim manjšim. Seznam in velikost (N) vzorcev za najdišča na območju Slovenije: Tonovcov grad (N = 13); Maharski prekop (bakrena doba; N = 3); Stare gmajne (bakrena doba; N = 2); Založnica (bakrena doba; N = 1); Gornja Radgona (pozna bronasta doba; N = 1); Gradec pri Mirni (starejša železna doba; N = 1); Kučar (starejša železna doba; N = 1); Ljubljana/*Emona* (rimska doba; N = 3); Sermin (rimska doba; N = 2); Školarice (rimska doba; N = 6); Ribnica na Dolenjskem/*Romula* (rimska doba; N = 28); Col (rimska doba; N = 5); Hrušica/*Ad Pirum* (rimska doba; N = 4); Pristava (zgodnji srednji vek; N = 2). Seznam in velikost (N) vzorcev za najdišča na območju Avstrije: Brixlegg (zgodnja bronasta doba; N = 25; Riedel 2003); Drösing (pozna antika; N = 12; 2007).

Fig. 8.16: Diagram of PC 1 scores, calculated on the basis of the correlation matrix of metric data referable to three astragalus dimensions in the material from Tonovcov grad (sample 3) and a number of prehistoric (sample 1), Roman (sample 2) and Late Antiquity or Early Medieval (sample 4) sites in the broader region. Due to the negative sign of all four factor loadings the larger specimens show lower PC 1 scores compared to the smaller ones. The list and size (N) of the samples for the sites in the territory of Slovenia: Tonovcov grad (N = 13); Maharski prekop (Copper Age; N = 3); Stare gmajne (Copper Age; N = 2); Založnica (Copper age; N = 1); Gornja Radgona (Late Bronze Age; N = 1); Gradec pri Mirni (Early Iron Age; N = 1); Kučar (Early Iron Age; N = 1); Ljubljana/*Emona* (Roman period; N = 3); Sermin (Roman period; N = 2); Školarice (Roman period; N = 6); Ribnica na Dolenjskem/*Romula* (Roman period; N = 28); Col (Roman period; N = 5); Hrušica/*Ad Pirum* (Roman period; N = 4); Pristava (Early Middle Ages; N = 2). List and size (N) of the samples for the sites in Austria: Brixlegg (Early Bronze Age; N = 25; Riedel 2003); Drösing (Late antiquity; N = 12; 2007).

dimensions of the cattle astragali to greatly correlate to the weight of the animals (*cf.* Bartosiewicz 1984).

Testing the differences in PC1 scores between the individual samples included in *figure 8.16* has shown that they exceed the limit of statistical significance (Kruskal-Wallis ANOVA test:  $H [3, 109] = 22.51$ ;  $p = 0.000$ ). Of course, this heterogeneity can be mainly attributed to the significantly higher average of the Roman period cattle, which is mostly attributable to the presence of the large "Roman" form/breed. On the other hand, there are no substantial differences between the materials from Tonovcov grad and those from other Late Antique and Early Medieval sites in the broader region, nor are there any differences between the data from Tonovcov grad and those relative to Iron Age sites (Mann-Whitney U test:  $U = 144.0$ ;  $Z = -1.83$ ;  $p = 0.067$ ). This ascertainment was to be expected and is perfectly in line with the thesis of the relatively rapid loss of knowledge associated with the breeding of large "Roman" cattle once the Empire collapsed and the resulting shift of cattle husbandry towards the smaller local primitive cattle forms as they were known in these territories already in the Iron Age. Minor differences between the prehistoric assemblage on one side and that from Tonovcov grad (as well as from other Late Antique sites) on the other can most likely be explained by the presence of individual Copper and/or Bronze Age specimens within the prehistoric assemblage. As is known the largest prehistoric domestic cattle are to be found in Neolithic contexts; later on they gradually became smaller (Bököny 1974, Fig. 7.9).

If the first principal component (PC 1) represents the size vector, then the second and the third (i.e. PC 2 and PC 3) can be understood as carriers of the shape information. In the aforementioned principal component analysis the second and third principal components account for an abundant ten percent of the total variance within the initial data set (see footnote No. 47). Similar as with PC 1, statistically significant differences in the distribution of scores along the second principal component has been observed, while only minor discrepancies emerged from the comparison of PC 3 scores. As seen in *figure 8.17*, Roman period finds show higher PC 2 scores relative to prehistoric<sup>49</sup> or Late Antique/Early Medieval<sup>50</sup> specimens, with the astragali from Tonovcov grad occupying an intermediate position between the two extremes. The values of factor loadings (*Tab. 8.16*) indicate that the specimens showing higher PC2 scores (i.e. Roman period finds) are relatively narrower than those with lower PC2 scores (i.e. prehistoric specimens). At this it is interesting that the greatest depth of the astragalus medial side (GLm)<sup>51</sup> increases faster than the greatest breadth of the distal part (Bd) of the same

<sup>49</sup> Mann-Whitney U test:  $U = 532.0$ ;  $Z = -2.18$ ;  $p = 0.029$ .

<sup>50</sup> Mann-Whitney U test:  $U = 252.0$ ;  $Z = 2.23$ ;  $p = 0.026$ .

<sup>51</sup> The same holds true also for the greatest length on the lateral side (i.e. GLL *sensu* von den Driesch 1976).

za Tonovcov grad in tistimi z železnodobnih najdišč (Mann-Whitneyjev U-test:  $U = 144,0$ ;  $Z = -1,83$ ;  $p = 0,067$ ). Ugotovitev potrjuje tezo o razmeroma hitri izgubi znanj povezanih z vzrejo velikih goved po razpadu imperija ter posledičen premik težišča govedoreje na majhne primitivne forme lokalnega izvora, kakršne so v teh krajih poznali že v železni dobi. Določene razlike med prazgodovinskim vzorcem na eni strani ter tistim s Tonovcovega gradu (pa tudi ostalih poznoantičnih najdišč) na drugi gre najverjetneje pripisati prisotnosti bakrenodobnih in bronastodobnih primerkov v prazgodovinskem vzorcu; velikost goved je bila v prazgodovini na območju srednje Evrope namreč največja v mlajši kameni dobi, nato pa je vseskozi postopoma upadala (Bökönyi 1974, sl. 9).

Če je prva glavna komponenta vektor velikosti, potem lahko drugi dve (PC 2 in PC 3) razumemo kot nosilki oblikovne informacije. V primeru zgoraj predstavljene analize glavnih komponent slednji opisujeta dobrih deset odstotkov variance osnovnega nabora podatkov (glej opombo 44). Za razliko od vrednosti PC3, kjer razlik med posameznimi vzorci nisva ugotovila, pa te pri porazdelitvi vrednosti vzdolž druge glavne komponente obstajajo (sl. 8.17). Rimskodobni primerki namreč izkazujejo statistično značilno višje vrednosti PC2 od prazgodovinskih<sup>47</sup> ter tudi poznoantičnih/zgodnjerednjeveških<sup>48</sup> skočnic; pri tem primerki s Tonovcovega gradu zasedajo vmesno lego med obema skrajnostma. Iz vrednosti faktorskih uteži (*Factor loadings*; tab. 8.16) izhaja, da so skočnice z višjimi vrednostmi PC2 (tj. rimskodobne skočnice) relativno ožje od tistih z nižjimi vrednostmi PC2 (tj. prazgodovinski primerki). Pri tem je zanimivo, da se pri govedu največja širina medialnega dela (GLm)<sup>49</sup> skočnice z naraščanjem mase živali domnevno povečuje hitreje od največje širine distalnega dela (Bd) istega skeletnega elementa (linearna<sup>50</sup> regresijska enačba:  $Bd = 6,798 + 0,579 * GLm$ ; Pearsonov koeficient korelacije:  $r = 0,67$ ;  $p = 0,000$ ). Takšen je vsaj trend, ki ga je mogoče razbrati iz metričnih podatkov za vzorec bronastodobnih govejih skočnic z Madžarskega (Bartosiewicz 1984, Tab. 1), ki sicer vključuje tako odrasle primerke obeh spolov kot tudi teleta. Pri tem velja poudariti, da je zgornja regresijska enačba bolj ali manj neodvisna od spreminjanja razmerij med starostnimi kategorijami oz. med spoloma v izhodiščnem vzorcu. Podobno velja tudi za Pearsonove koeficiente korelacije med dimenzijama GLm oz. Bd na eni strani ter ocenjeno

<sup>47</sup> Mann-Whitneyjev U-test:  $U = 532,0$ ;  $Z = -2,18$ ;  $p = 0,029$ .

<sup>48</sup> Mann-Whitneyjev U-test:  $U = 252,0$ ;  $Z = 2,23$ ;  $p = 0,026$ .

<sup>49</sup> Enako velja tudi za največjo dolžino lateralnega dela skočnice (tj. GLl).

<sup>50</sup> Primernost uporabe linearne regresije dokazuje porazdelitev ostankov (*Residuals*), saj ti ne izkazujejo statistično značilnih odstopanj od normalne porazdelitve (Shapiro-Wilkov W-test:  $p > 0,05$ ).

Tab. 8.16: Faktorske uteži (*Factor loadings*) za posamezno od prvih treh glavnih komponent (PC), izračunanih na osnovi korelacijske matrike metričnih podatkov treh dimenzij skočnic s Tonovcovega gradu ter z več prazgodovinskih, rimskodobnih in poznoantičnih najdišč v širši regiji.

Tab. 8.16: Factor loadings for first three principal components (PC), calculated on the basis of the correlation matrix of metric data referable to three astragalus dimensions in the material from Tonovcov grad and from numerous prehistoric, Roman period and Late Antique sites in the broader region.

Dimenzija Dimension	PC 1	PC 2	PC 3
GLm	-0,95	0,22	0,23
Dl	-0,95	0,14	-0,26
Bd	-0,92	-0,38	0,03

skeletal element (linear<sup>52</sup> regression equation:  $Bd = 6.798 + 0.579 * GLm$ ; Pearson correlation coefficient:  $r = 0.67$ ;  $p = 0.000$ ), as it was observed in the measurements obtained from Bronze Age specimens from Hungary (Bartosiewicz 1984, Tab. 1), which includes adult specimens of both sexes as well as calves. In relation to this it is worth noting, that the regression equation is more or less independent from the fluctuating share of individual age groups or sexes in the assemblage. Similar holds true for the Pearson correlation coefficients between the dimensions GLm (or Bd) on one hand and the estimated cattle weight on the other (cf. Bartosiewicz 1984, Tab. 1), as they never fall below 0.80.

The existence of two groups of astragali, differing in shapes (and not merely size), could be associated with the presence of two cattle forms (breeds?) in the studied area, i.e. the advanced "Roman" and the traditional local form. The existence of statistically significant differences between the material from prehistoric or Late Antique/Early Medieval sites on the one hand, and those from the Roman period on the other, may – in this case – reflect the lack (scarcity) of large cattle prior to the Romanisation of this area or following the fall of the Empire. Of course, as "Roman" cattle did not establish itself at once, it did not suddenly disappear either. The somewhat intermediate position of the sample from Tonovcov grad in figure 8.17 could thus be due to the slightly higher representation of the large cattle form(s)/breed(s) as opposed to the situation at some other sites from the mid or second half of the first millennium. After all, the bulk<sup>53</sup> of the specimens included in the Late Antique/Early Medieval assemblage shown on figure 8.17 is

<sup>52</sup> The appropriateness of using linear regression is proven by the distribution of residuals, for it does not show statistically significant deviation from the normal distribution (Shapiro-Wilk W test:  $p > 0.05$ ).

<sup>53</sup> The sample also includes two specimens from the Early Medieval site of Pristava at Bled (Toškan, Dirjec 2008).

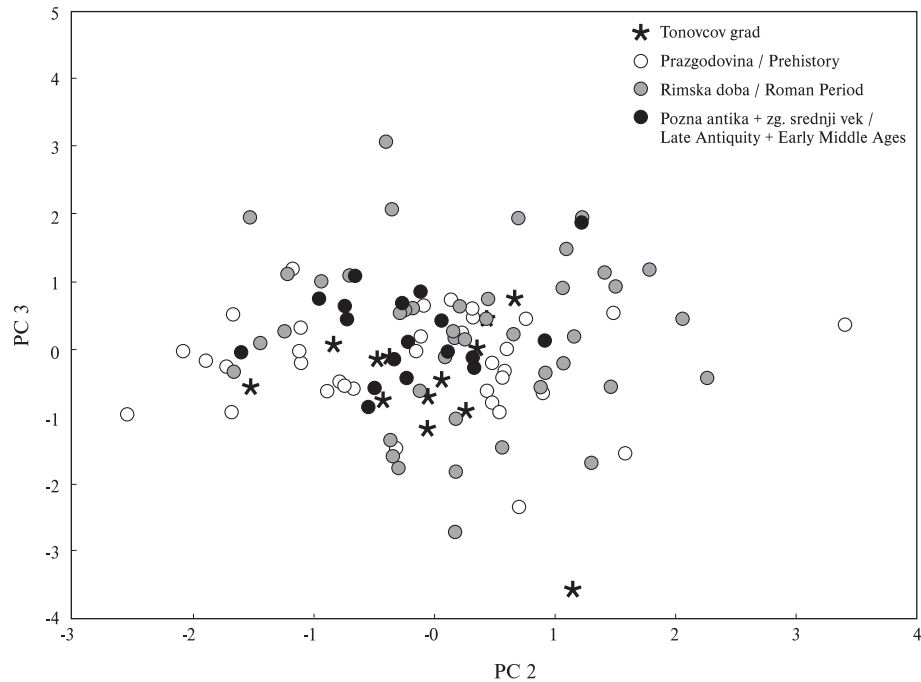

Sl. 8.17: Grafični prikaz odnosa med vrednostmi druge in tretje glavne komponente (PC 2 & PC 3 scores), izračunane na osnovi korelacijske matrike metričnih podatkov treh dimenzij skočnic s Tonovcovega gradu ter z več prazgodovinskih, rimskodobnih in poznoantičnih najdišč v širši regiji. Za seznam in velikost vzorcev glej pripis k sliki 8.16.

Fig. 8.17: Graphic representation of the relation between PC 2 and PC 3 scores, calculated on the basis of the correlation matrix of the metric data referable to three astragalus dimensions in the material from Tonovcov grad and a number of prehistoric, Roman and Late Antiquity sites in the broader region. For a list and samples and their size see text under figure 8.16.

maso goved na drugi (cf. Bartosiewicz 1984, Tab. 1), saj ti nikoli ne padejo pod vrednost 0,80.

Obstoj dveh skupin govejih skočnic, ki se med seboj razlikujejo po obliki (in ne le velikosti), bi lahko povezovali s prisotnostjo dveh oblik (pasem?) goveda v tem prostoru, tj. napredne "rimske" in tradicionalne lokalne. V statistično značilnih razlikah med gradivom s prazgodovinskih oz. poznoantičnih/zgodnjesrednjeveških najdišč na eni strani ter rimskodobnih na drugi bi se v tem primeru lahko odražala prav odsotnost (maloštevilnost) velikih goved pred romanizacijo obravnavanega prostora oz. po razpadu cesarstva. Seveda se "rimsko" govedo v našem prostoru ni uveljavilo naenkrat, tako kot tudi ni naenkrat izginilo. Skočnice s Tonovcovega gradu se tako morda na sliki 8.17 umeščajo med skočnice z rimskodobnih in tiste s poznoantičnih/zgodnjesrednjeveških najdišč prav zaradi še vedno nekoliko večje zastopanosti napredne oblike goveda nasproti stanju na nekaterih drugih najdiščih s sredine oz. druge polovice prvega tisočletja. Pretežni del<sup>51</sup> skočnic v poznoantičnem/zgodnjesrednjeveškem vzorcu s slike 8.17 namreč predstavljajo najdbe z najdišča Drösing, ki leži severno od Donave, torej onkraj meja rimskega cesarstva (Riedel 2007). Tu pa je do zmanjševanja prisotnosti velikih

represented by finds from the site of Drösing north of the Danube, and thus beyond the borders of the Roman Empire (Riedel 2007). As already stated above, in such peripheral areas the large "Roman" cattle disappeared significantly sooner than in the Southeastern Alps.

The presence of individual specimens from advanced "Roman" cattle within the assemblage from Tonovcov grad is evident also from figure 8.18, which shows the relationship between the breadth and depth of the distal tibia epiphysis in specimens originating from several prehistoric and Roman period as well as one Early Medieval site in the territory of present-day Slovenia. As can be seen the largest finds are those of Roman period animals; nevertheless, a single distal tibia does come also from Tonovcov grad.<sup>54</sup> Given that in figure 8.18 we did not distinguish between males and females, an important part of the observed variability can of course be attributed to sexual dimorphism and not to the presence of two (or more?) different cattle forms/breeds. However, the overlap between the measurements of local and "Roman" cattle is to be expected in the central part of the "cloud" where males and castrates of the former as well as females of the latter are to be found. This can be clearly seen from the range of

<sup>51</sup> Vzorec sicer vključuje še dva primerka z zgodnjesrednjeveške Pristave na Bledu (Toškan, Dirjec 2008).

<sup>54</sup> The find originates from the oldest Roman period settlement phase (i.e. the Late Antiquity phase 1), which may well not be a coincidence.

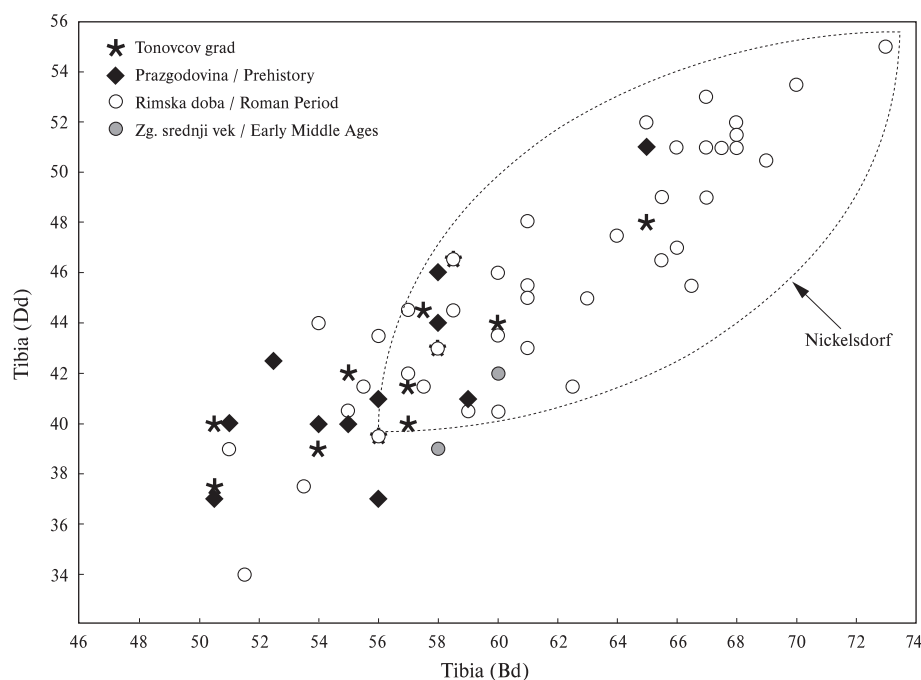

Sl. 8.18: Grafični prikaz razmerja med največjo širino (Bd) in največjo globino (Dd) distalne epifize golenice domačega goveda z več različnih najdišč z območja današnje Slovenije. Označeno polje ponazarja razpon vrednosti obeh dimenzij za domače govedo z rimskodobnega najdišča Nickelsdorf (Riedel 2004, Tab. 42). Seznam in velikost (N) vzorcev: Tonovcov grad (N = 12); Maharski prekop (bakrena doba, N = 4); Gornja Radgona (bronasta doba, N = 2); Cvinger (železna doba, N = 1); Vače (železna doba, N = 1); Veliki Vinji vrh (železna doba, N = 4); Bela Cerkev (železna doba, N = 1); Ribnica na Dolenjskem/Romula (rimska doba, N = 32); Vipava: telovadnica (rimska doba, N = 2); Gorenje Skopice (rimska doba, N = 2); Ljubljana/Emona (rimska doba, N = 5); Školarice (rimska doba, N = 2); Hrušica/Ad Pirum (rimska doba, N = 3); Pristava (zgodnji srednji vek, N = 2). Metrične podatke za najdišče Pristava podajata Toškan in Dirjec (2008, 150), preostanek pa predstavljajo lastni neobjavljeni podatki. Vse mere so v mm.

Fig. 8.18: Graphic representation of the relation between the greatest breadth (Bd) and the greatest depth (Dd) of tibial distal epiphyses of cattle from a number of different sites in the territory of present day Slovenia. The marked field denotes the range of values for both dimensions observed in cattle from the Roman period site of Nickelsdorf (Riedel 2004, Tab. 42). The list and size (N) of samples: Tonovcov grad (N = 12); Maharski prekop (Copper Age, N = 4); Gornja Radgona (Bronze Age, N = 2); Cvinger (Iron Age, N = 1); Vače (Iron Age, N = 1); Veliki Vinji vrh (Iron Age, N = 4); Bela Cerkev (Iron Age, N = 1); Ribnica na Dolenjskem/Romula (Roman period, N = 32); Vipava: gym (Roman period, N = 2); Gorenje Skopice (Roman period, N = 2); Ljubljana/Emona (Roman period, N = 5); Školarice (Roman period, N = 2); Hrušica/Ad Pirum (Roman period, N = 3); Pristava (Early Middle Ages, N = 2). The metric data for the site of Pristava was provided by Toškan and Dirjec (2008, 150), while the rest is represented by personal unpublished data. All measurements are in mm.

“rimskih” goved prišlo vendarle prej kot na območju jugovzhodnih Alp.

Prisotnost naprednih “rimskih” goved v vzorcu s Tonovcovega gradu dokazuje tudi *slika 8.18*, kjer je prikazano razmerje med širino in globino distalnega dela golenice za posamezna prazgodovinska in rimskodobna ter eno zgodnesrednjeveško najdišče na Slovenskem. Med največjimi primerki, ki jih skoraj izključno predstavljajo rimskodobne golenice, je namreč tudi ena s Tonovcovega gradu.<sup>52</sup> Glede na to, da na *sliki 8.18* nisva razlikovala med golenicami samcev in samic, je seveda pomemben del izkazane variabilnosti utemeljeno pripisati prav spolnemu dimorfizmu in ne prisotnosti dveh (več?) različnih oblik goveda. Vendar pa lahko prekrivanje metričnih podatkov o

<sup>52</sup> Najdba (morda ne po naključju) izvira iz starejše, tj. prve faze poznoantične poselitve najdišča.

cattle tibia measurements from the Roman period site of Nickelsdorf in Eastern Austria, where the remains of only the large “Roman” cattle were found (Riedel 2004, 465 ff).<sup>55</sup> It should thus not be considered speculative to conclude that the largest specimens from *figure 8.18* (including at least one from Tonovcov grad)<sup>56</sup> are to be reliably related to the advanced “Roman” form/breed, despite the heterogeneous composition of the assemblage in terms of sex.

The analysis of the size of cattle from Tonovcov grad will be concluded with the comparison between the materials from both Late Antiquity settlement phases

<sup>55</sup> The estimate of the sex profile for the material from Nickelsdorf shows an equal share of both sexes (N = 36). In the case of Tonovcov grad we have sexed 15 sufficiently preserved pelvis fragments, ascribing 13 specimens to cows and two to oxen.

<sup>56</sup> See also *table 8.3*.

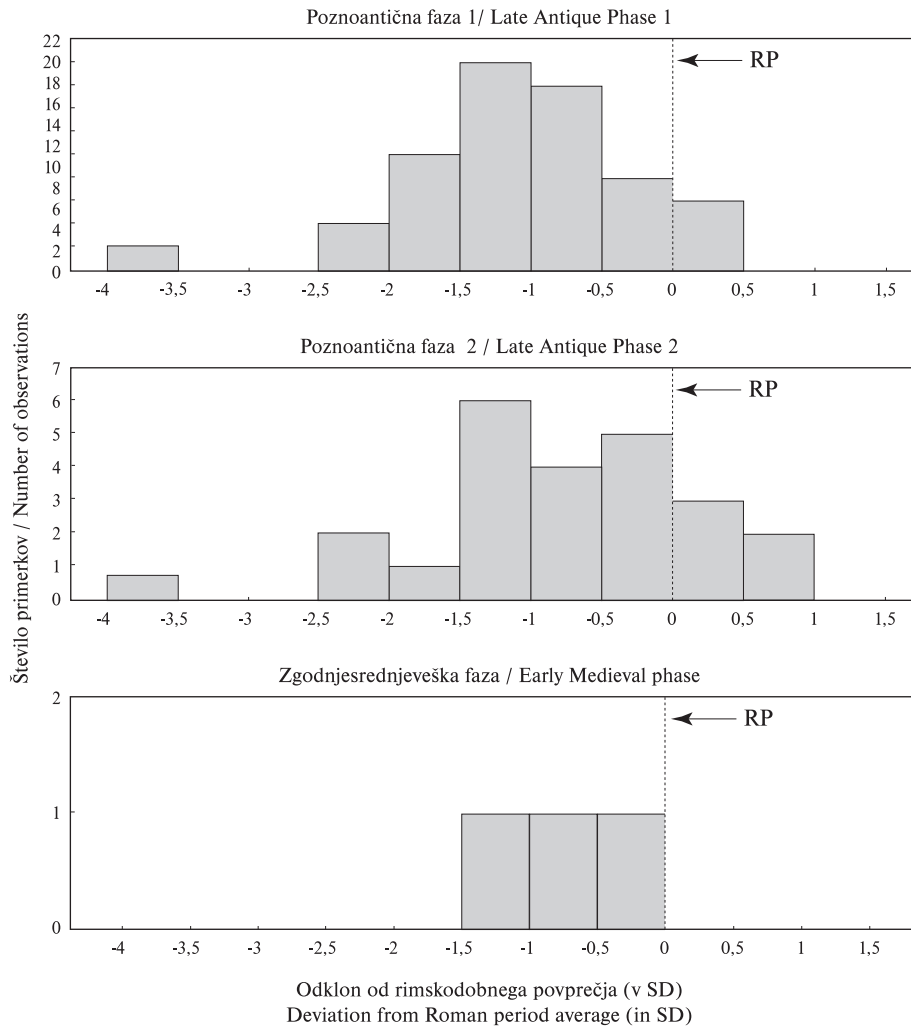

Sl. 8.19: Porazdelitev standardiziranih dimenzij dolgih kosti (nadlahtnica, koželjnica, dlančnica, golenica, stopalnica) ter petnic in skočnic domačega goveda s Tonovcovega gradu po posameznih fazah. Vsak skeletni element je zastopan le s po eno dimenzijo. Postopek standardiziranja dimenzij je podan v pogl. 8.1. Legenda: RP – rimskodobno povprečje, izračunano na osnovi govejih ostankov iz rimskega mesta Tác/*Gorsium* (Madžarska; Bökönyi 1984).

Fig. 8.19: Distribution of standardised metric data of cattle long bones (humerus, radius, metacarpus, tibia, metatarsus) as well as calcanei and astragali from Tonovcov grad, by settlement phases. Every skeletal element is represented by a single measure. The procedure for standardising the metric data is given in chapter 8.1. Legend: RP – Roman Period average, calculated on the basis of cattle remains from the Roman town of Tác/*Gorsium* (Hungary; Bökönyi 1984).

lokalnem in "rimskem" govedu pričakujemo predvsem na osrednjem delu "oblaka", kjer se umeščajo tako samci in kastrati prvih kot tudi samice drugih. To je lepo razvidno iz razpona vrednosti obeh merjenih dimenzij za domače govedo z rimskodobnega najdišča Nickelsdorf v vzhodni Avstriji, kjer so sicer našli izključno na ostanke velikega "rimskega" goveda (Riedel 2004, 465 ss).<sup>53</sup> Iz navedenega izhaja, da je največje primerke s slike 8.18 (vključno z vsaj enim s Tonovco-

<sup>53</sup> Ocenjena spolna struktura za gradivo iz Nickelsdorfa kaže primerljiv delež obeh spolov (N = 36). V primeru Tonovcovega gradu sva spol ugotavljala pri 15 ustrezno ohranjenih fragmentih medenice, od katerih sva jih 13 pripisala kravam, preostala dva pa volom.

(Fig. 8.19). The results showed no substantial differences, thus contradicting the possibility of the existence of any noticeable change in the (average) size of these animals between the end of the 4<sup>th</sup> century all the way to the beginning of the 7<sup>th</sup> century. The same holds true also if the small Early Medieval assemblage is also considered.<sup>57</sup> Such a conclusion is in line with what has been described above (Figs. 8.15-8.18) and was thus to be expected. It indicates that in the broader area of Tonovcov grad the process of substituting the advanced "Roman" breed of cattle with the small local form had most likely ended before the first Late Antiquity settlement phase of the site

<sup>57</sup> Kruskal-Wallis ANOVA: H (2, N = 58) = 2.81; p = 0.245.

vega gradu)<sup>54</sup> navkljub spolno heterogenemu vzorcu vendarle utemeljeno pripisati napredni "rimski" obliki.

Analizo velikosti domačega goveda s Tonovcovega gradu končujeva s primerjavo med gradivom iz obeh faz poznoantične poselitve (sl. 8.19). Omembe vrednih razlik nisva ugotovila, tako da o opaznejšem trendu spreminjanja velikosti živali v obdobju od konca 4. pa tja do začetka 7. stoletja na podlagi razpoložljivih podatkov ne moreva govoriti. Kot so pokazali rezultati statističnega testiranja, takšnih trendov ni zaznati niti ob hkratnem upoštevanju gradiva zgodnesrednjeveške starosti (tj. zgodnesrednjeveške faze),<sup>55</sup> ki sicer izstopa po razmeroma skromnem številu najdb. Ugotovitev je po svoje pričakovana, saj se je na obravnavanem območju proces prenosa težišča govedoreje z napredne "rimske" oblike na majhno lokalno govedo v pretežnem delu domnevno končal še pred prvo fazo poznoantične poselitve Tonovcovega gradu (sl. 8.15–8.19). Morebitni nadaljnji upad povprečne velikosti goved v 8. in morda 9. stoletju (cf. Toškan, Dirjec 2008, Tab. 6A) pa bi bilo spričo skromnosti razpoložljivega vzorca iz zgodnesrednjeveške faze tako ali tako zelo težko zaznati.

### 8.5.2 OVCA

Podobno kot pri domačem govedu se je z začetkom rimskega obdobja povečala tudi povprečna velikost ovac, k čemur je prispeval predvsem uvoz naprednih "rimskih" oblik (Bökönyi 1974, sl. 49). Njihovo število se je v nemirnem obdobju preseljevanja ljudstev nato postopoma manjšalo, kar se v arheozoološkem zapisu kaže predvsem kot upad povprečne velikosti posameznih skeletnih elementov. Podobno kot pri govedu je tudi do usihanja števila naprednih "rimskih" ovac najprej prišlo v bolj oddaljenih provincah, medtem ko so se v nižinskem in predalpskem delu severne Italije obdržale vse tja do zgodnjega srednjega veka (Riedel 1994b, 54).

Glede na zgoraj navedeno je primerjava standardiziranih metričnih podatkov ovčjih kosti s Tonovcovega gradu in pa tistih z več sočasnih najdišč severne Italije, Avstrije in zahodne Madžarske dala pričakovane rezultate (sl. 8.20). Ovce z italijanskih naselbin Invillino, Videm/Udine in Verona (skupek VR-1) so bile namreč v povprečju statistično značilno večje od ovac s Tonovcovega gradu<sup>56</sup> oz. sočasnih avstrijskih najdišč. Po drugi strani primerjava Tonovcovega gradu z najdišči proti vzhodu ni izpostavila omembe vrednih razlik.<sup>57</sup>

<sup>54</sup> Glej tudi *tabelo 8.3*.

<sup>55</sup> Kruskal-Wallisova ANOVA:  $H(2, N = 58) = 2,81$ ;  $p = 0,245$ .

<sup>56</sup> Mann-Whitneyjev U-test:  $U = 337,5$ ;  $Z = -2,34$ ;  $p = 0,019$ .

<sup>57</sup> Primerjava med ovcami s Tonovcovega gradu in tistimi s sočasnih najdišč v Avstriji oz. na Madžarskem: Mann-Whitneyjev U-test:  $U = 179,0$ ;  $Z = -0,73$ ;  $p = 0,468$ . Primer-

studied here even begun. Given the modest assemblage size dated to the Early Medieval phase any further decline in the average size of cattle in the 8<sup>th</sup> and possibly 9<sup>th</sup> century, although expected (cf. Toškan, Dirjec 2008, Tab. 6A), would be rather hard to detect.

### 8.5.2 SHEEP

As was the case with cattle, the beginning of the Roman period in Central Europe also saw an increase in the average size of sheep, which was presumably a result of the imports of the advanced "Roman" form/breed (Bökönyi 1974, Fig. 49). During the turbulent Migration period the presence of the latter breed gradually declined, which is reflected in the arheozoological record in the drop of the average size of individual skeletal elements. Similar to cattle the number of advanced "Roman" sheep first dwindled in the more remote provinces, while those in the north Italian lowlands and Pre-Alpine hills remained rather numerous until the Early Medieval period (Riedel 1994b, 54).

With the above in mind the results of the comparison between the standardized measurements of sheep bones from Tonovcov grad with those from several contemporary sites in north Italy, Austria and west Hungary are all but surprising (Fig. 8.20). Sheep from settlements of Invillino, Udine and Verona (complex VR-1) in Italy were on average statistically significantly larger than those from Tonovcov grad<sup>58</sup> or Austrian sites from the same period. On the other hand, comparing Tonovcov grad with sites in the east did not show any substantial difference.<sup>59</sup>

Figure 8.20 shows that Late Antique sheep from the territory of present-day Slovenia formed a metrically rather homogeneous population. In contrast to this the comparison between the standardized measurements of Late Antique sheep long bones and the material dated to the period between the 1<sup>st</sup> and 4<sup>th</sup> centuries AD demonstrates considerable metric heterogeneity. On average the sheep from Tonovcov grad were statistically significantly smaller than those from the e.g. Roman period site of Ribnica/Romula.<sup>60</sup> This was allegedly due to the higher numbers of advanced "Roman" sheep in the latter assemblage.

<sup>58</sup> Mann-Whitney U test:  $U = 337,5$ ;  $Z = -2,34$ ;  $p = 0,019$ .

<sup>59</sup> The comparison between the sheep from Tonovcov grad and those from the contemporary sites in Austria and Hungary: Mann-Whitney U test:  $U = 179,0$ ;  $Z = -0,73$ ;  $p = 0,468$ . The comparison between the material from Tonovcov grad and Ajdovski Gradec above Vranje: Mann-Whitney U test:  $U = 378,0$ ;  $Z = 0,02$ ;  $p = 0,980$ . The remains from Tonovcov grad and Ajdovski Gradec did not show any statistically significant differences amongst goat remains (Mann-Whitney U test:  $U = 17,0$ ;  $Z = -1,27$ ;  $p = 0,203$ ).

<sup>60</sup> Mann-Whitney U test:  $U = 47,0$ ;  $Z = -3,11$ ;  $p = 0,002$ . Standardized measurements for long bones were used as a size indicator.

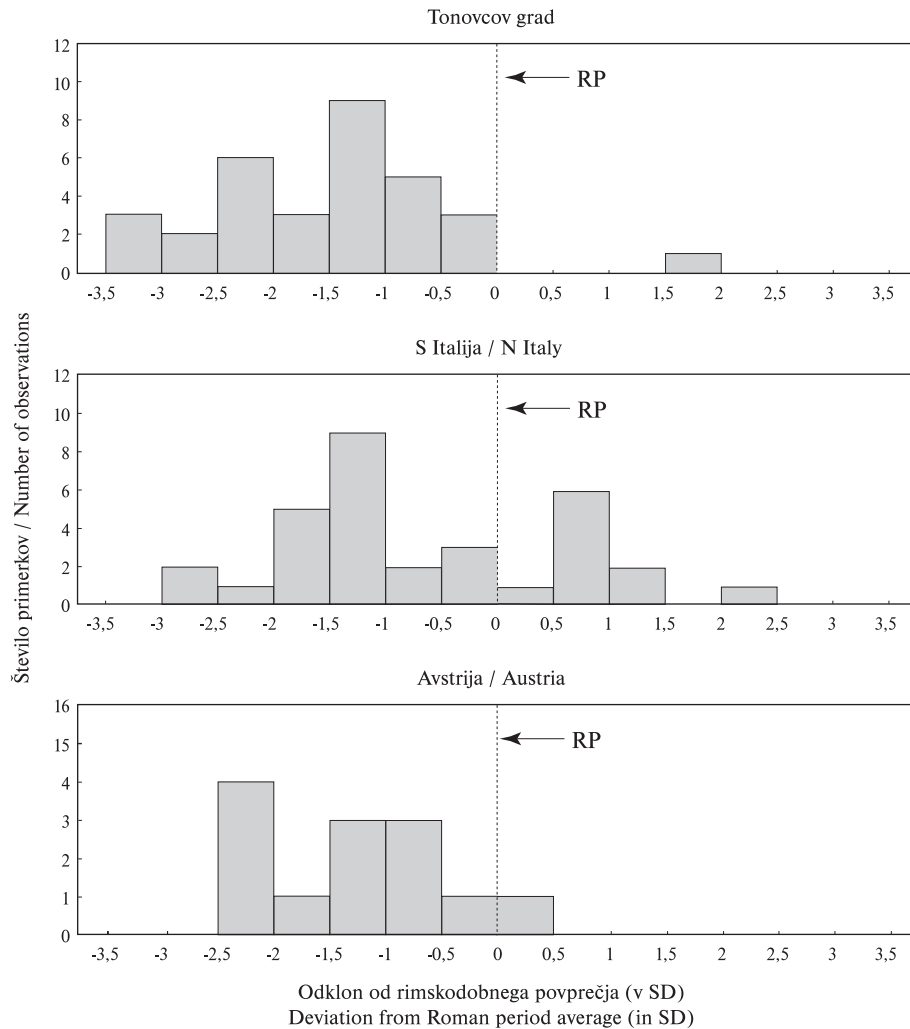

Sl. 8.20: Porazdelitev standardiziranih dimenzij dolgih kosti (nadlahtnica, dlančnica, stopalnica) ovce s Tonovcovega gradu ter z več sočasnih najdišč severne Italije, Avstrije in zahodne Madžarske. Vsak skeletni element je zastopan le s po eno dimenzijo. Postopek standardiziranja dimenzij je podan v pogl. 8.1. Legenda: RP – rimskodobno povprečje, izračunano na osnovi ovčjih ostankov iz rimskega mesta Tác/Gorsium (Madžarska; Bökönyi 1984). Seznam najdišč S Italije: Invillino (Stork, von den Driesch 1987); Videm/Udine, grad (Riedel 1993b); Verona: skupek VR-I (Riedel 1994a). Seznam najdišč Avstrije: Kappele (Pucher 1993); Sveta Hema/Hemmaberg (Forstenpointner *et al.* 2002); Drösing (Riedel 2007). Najdišče z zahodne Madžarske: Sopron/Scarbantia (Bökönyi 1986).

Fig. 8.20: Distribution of standardised metric data of sheep long bones (humerus, metacarpus, metatarsus) as well as calcanei and astragali from Tonovcov grad and from a number of contemporary sites in Northern Italy, Austria and Western Hungary. Each skeletal element is represented by a single measure. The procedure for standardising the metric data is given in chapter 8.1. Legend: RP – Roman Period average, calculated on the basis of sheep remains from the Roman town of Tác/Gorsium (Hungary; Bökönyi 1984). The list of sites in N Italy: Invillino (Stork, von den Driesch 1987); Udine, castle (Riedel 1993b); Verona: complex VR-I (Riedel 1994a). List of sites in Austria: Kappele (Pucher 1993); Hemmaberg (Forstenpointner *et al.* 2002); Drösing (Riedel 2007). Site in Western Hungary: Sopron/Scarbantia (Bökönyi 1986).

Sodeč po *sliki 8.20* so torej ovce na Slovenskem v pozni antiki tvorile metrično razmeroma homogeno populacijo. V nasprotju s tem kaže primerjava standardi-

java med gradivom s Tonovcovega gradu in z Ajdovskega Gradca nad Vranjem: Mann-Whitneyjev U-test:  $U = 378,0$ ;  $Z = 0,02$ ;  $p = 0,980$ . Med ostanki s Tonovcovega gradu in tistimi z Ajdovskega Gradca statistično značilnih razlik nisva ugotovila niti v primeru koz (Man-Whitneyjev U-test:  $U = 17,0$ ;  $Z = -1,27$ ;  $p = 0,203$ ).

Contrary to the above, the comparison between the withers heights of prehistoric, Roman and Late Antique sheep has not shown any significant differences (Kruskal-Wallis test:  $p > 0.05$ ; Fig. 8.21). Is the observed discrepancy between the outcomes of the two comparisons (i.e. Fig. 8.20 vs. Fig. 8.21) explainable with the latter assemblages being much smaller than was the case with the comparison between the standardized measurements of long bones (Fig. 8.20)? At least in

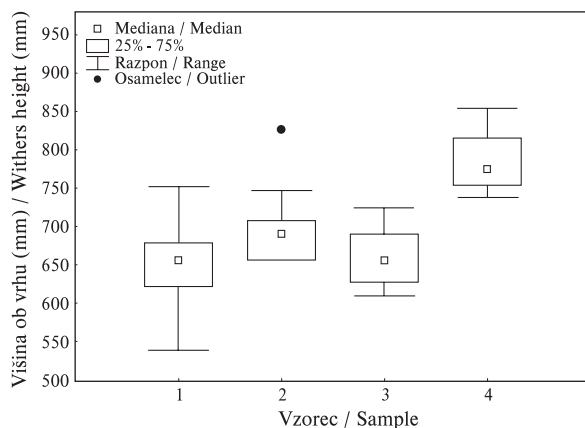

ziranih metričnih podatkov ovčjih dolgih kosti poznoantične starosti z gradivom iz obdobja med 1. in 4. stoletjem precejšnje metrično heterogenost. Ovce s Tonovcovega gradu so bile tako npr. v povprečju celo visoko statistično značilno manjše od tistih z rimskodobnega najdišča Ribnica na Dolenjskem,<sup>58</sup> domnevno zaradi večje številčnosti naprednih "rimskih" ovac v starejšem od obeh vzorcev. Velja pa v zvezi z zgoraj navedenim opozoriti, da primerjava plečne višine ovac prazgodovinske, rimskodobne in poznoantične starosti ni izpostavila podobno očitnih razlik med obdobji (test Kruskal-Wallis:  $p > 0,05$ ; sl. 8.21). Res je sicer, da so bili vzorci v slednjem primeru manjši kot ob primerjavi standardiziranih metričnih podatkov dolgih kosti (sl. 8.20), kar gotovo zmanjšuje njihovo reprezentativnost. Po drugi strani pa je tudi res, da vključuje poznoantično gradivo s *sl. 8.21* najdbe iz petih rimskodobnih najdišč, medtem ko sva standardizirane metrične podatke primerjala le med vzorcema s Tonovcovega gradu in Ribnice na Dolenjskem. Vprašanje številčnosti velikih "rimskih" ovac na Slovenskem v rimskem obdobju ostaja torej za zdaj brez dokončnega odgovora. Je pa tako na podlagi razlik v standardiziranih metričnih podatkih med gradivom s Tonovcovega gradu in z rimskodobnega mesta *Tác/Gorsium* (sl. 8.20) kot tudi iz razlike med višino ob vihru ovac s tukaj obravnavanega najdišča in iz rimskodobne vile rustike v avstrijskem Nickelsdorfu<sup>59</sup> (sl. 8.21) nedvoumno razvidno, da je bilo na Tonovcovem gradu velikih "rimskih" ovac razmeroma malo, tako da je ovčereja temeljila predvsem na primitivni lokalni obliki pasme te vrste.

Primerjava standardiziranih metričnih podatkov ovčjih ostankov iz obeh faz poznoantične poselitve Tonovcovega gradu ne kaže na obstoj statistično značilnih trendov spreminjanja velikosti v času (Mann-Whitneyjev U-test:  $U = 28,5$ ;  $Z = -1,35$ ;  $p = 0,177$ ; sl. 8.22). Skladni s tem so rezultati medfazne primerjave višine ob

<sup>58</sup> Mann-Whitneyjev U-test:  $U = 47,0$ ;  $Z = -3,11$ ;  $p = 0,002$ . Kot kazalnik velikosti sva uporabila standardizirane metrične podatke dolgih kosti.

<sup>59</sup> V okviru vile rustike v Nickelsdorfu so bili najdeni le ostanki velikih "rimskih" ovac (Riedel 2004, 478 s).

Sl. 8.21: Višina ob vihru za ovce s prazgodovinskih (vzorec 1), rimskodobnih (vzorec 2) in poznoantičnih (vzorec 3) najdišč ter iz vile rustike v avstrijskem Nickelsdorfu (vzorec 4; Riedel 2004). Višina ob vihru je bila ocenjena na osnovi največje dolžine lateralnega dela skočnice (GLI *sensu* von den Driesch 1976) z aplikacijo Teichertovih koeficientov (cf. Riedel 1986, 125). Seznam in velikost (N) vzorcev: Pupičina peč, Istra (mlajša kamena doba;  $N = 5$ ; Miracle, Pugsley 2006); Maharski prekop, Slovenija (bakrena doba;  $N = 1$ ); Brixlegg, Avstrija (zgodnja bronasta doba;  $N = 23$ ; Riedel 2003); Cvinger, Slovenija (starejša železna doba;  $N = 1$ ); Jama I na Prevali, Slovenija (starejša železna doba;  $N = 1$ ; Riedel 1977); Vrhnika/*Nauportus*, Slovenija (rimska doba;  $N = 1$ ); Ljubljana/*Emona*, Slovenija (rimska doba;  $N = 2$ ); Školarice, Slovenija (rimska doba;  $N = 2$ ); Ribnica na Dolenjskem/*Romula*, Slovenija (rimska doba;  $N = 5$ ); Hrušica/*Ad Pirum*, Slovenija (rimska doba;  $N = 1$ ); Tonovcov grad (pozna antika;  $N = 12$ ); Videm/Udine: grad, Italija (pozna antika;  $N = 3$ ; Riedel 1993b).

Fig. 8.21: The withers height of sheep from prehistoric (sample 1), Roman period (sample 2) and Late Antique (sample 3) sites as well as from the *villa rustica* at Nickelsdorf (sample 4, Austria; Riedel 2004). The withers height was estimated on the basis of the greatest length of the lateral part of astragali (GLI *sensu* von den Driesch 1976) and the application of Teichert's coefficient (cf. Riedel 1986, 125). List and size (N) of samples: Pupičina peč, Istria-Croatia (Early Stone Age;  $N = 5$ ; Miracle, Pugsley 2006); Maharski prekop, Slovenia (Copper Age;  $N = 1$ ); Brixlegg, Austria (Early Bronze Age;  $N = 23$ ; Riedel 2003); Cvinger, Slovenia (Late Iron Age;  $N = 1$ ); Jama I na Prevali, Slovenia (Late Iron Age;  $N = 1$ ; Riedel 1977); Vrhnika/*Nauportus*, Slovenia (Roman period;  $N = 1$ ); Ljubljana/*Emona*, Slovenia (Roman period;  $N = 2$ ); Školarice, Slovenia (Roman period;  $N = 2$ ); Ribnica na Dolenjskem/*Romula*, Slovenia (Roman period;  $N = 5$ ); Hrušica/*Ad Pirum*, Slovenia (Roman period;  $N = 1$ ); Tonovcov grad (Late Antiquity;  $N = 12$ ); Udine: castle, Italy (Late Antiquity;  $N = 3$ ; Riedel 1993b).

part the answer could be positive, as small assemblages are often far from being representative. On the other hand, it is also true that the Late Antique material from *figure 8.21* includes finds from five Roman period sites, while for the standardized measurements comparison only the assemblages from Tonovcov grad and Ribnica/*Romula* were used. Despite all, the discrepancies in the standardized measurements between the material from Tonovcov grad and the Roman town of *Tác/Gorsium* (Fig. 8.20), as well as the difference between the withers height of sheep from Tonovcov grad and those from the Roman *villa rustica* in Nickelsdorf, Austria,<sup>61</sup> (Fig. 8.21) clearly show that there were relatively few large "Roman" sheep at Tonovcov grad. It may thus be concluded that sheep exploitation appears to have been mainly based on the local primitive form(s).

The comparison between the standardized measurements of sheep remains from the two Late Antiquity settlement phases at Tonovcov grad is not indicative

<sup>61</sup> Only remains of the large "Roman" sheep were discovered in the *villa rustica* in Nickelsdorf (Riedel 2004, 478 s).



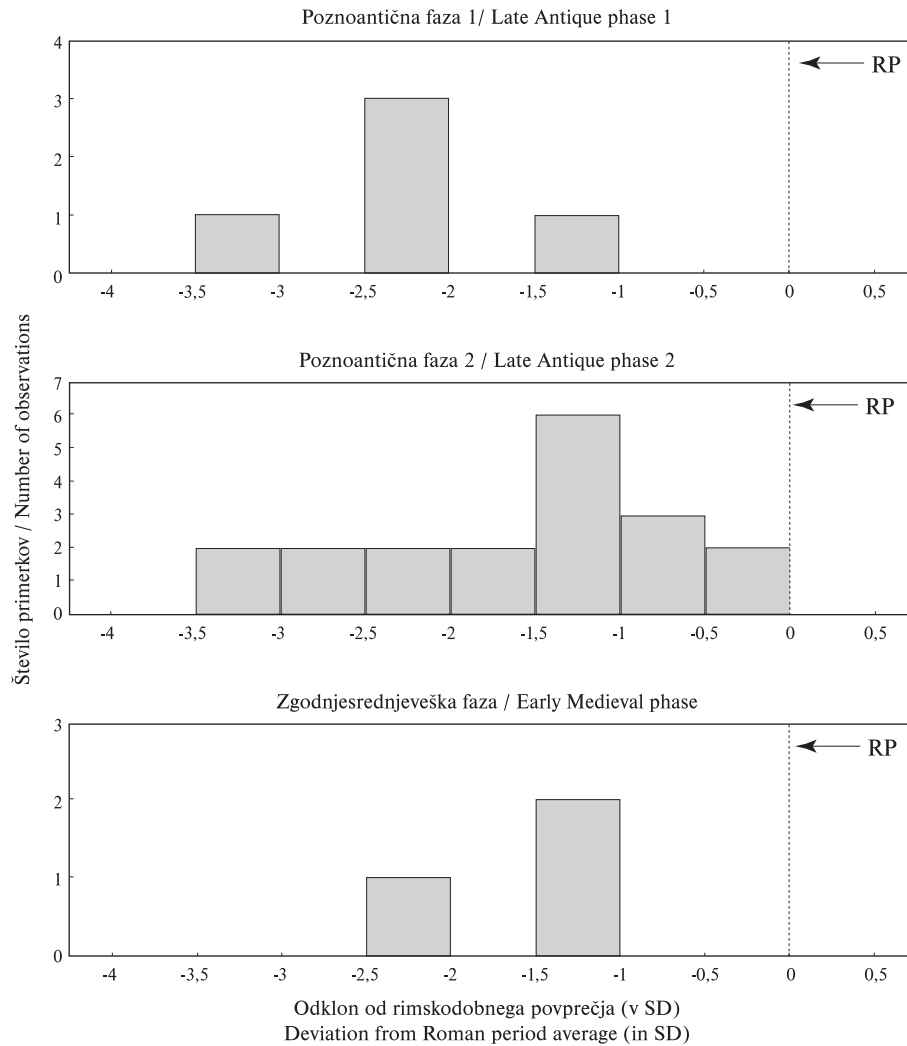

Sl. 8.22: Porazdelitev standardiziranih dimenzij dolgih kosti (nadlahtnica, dlančnica, stopalnica) ovce s Tonovcovega gradu po posameznih fazah. Vsak skeletni element je zastopan le s po eno dimenzijo. Postopek standardiziranja dimenzij je podan v pogl. 8.1. Legenda: RP – rimskodobno povprečje, izračunano na osnovi ovčjih ostankov iz rimskega mesta Tác/*Gorsium* (Madžarska; Bökönyi 1984).  
Fig. 8.22: Distribution of standardised metric data of sheep long bones (humerus, metacarpus, metatarsus) from Tonovcov grad, by individual settlement phase. Each skeletal element is represented by a single measure. The procedure for standardising the metric data is given in chapter 8.1. Legend: RP – Roman Period average, calculated on the basis of sheep remains from the Roman town of Tác/*Gorsium* (Hungary; Bökönyi 1984).

vihru, ocenjene na podlagi dimenzij skočnic in petnic; tudi v tem primeru namreč razlika med obema poznoantičnima fazama ne dosega meje statistične značilnosti (Mann-Whitneyjev U-test:  $U = 15,5$ ;  $Z = 0,38$ ;  $p = 0,700$ ;  $N = 13$ ). Podatkov za zgodnj srednjeveško fazo je sicer malo, a tudi ti ne odstopajo od razpona vrednosti za ovce poznoantične starosti (Kruskal-Wallisov ANOVA-test:  $H [2, N = 27] = 2,06$ ;  $p = 0,356$ ).

### 8.5.3 DOMAČI PRAŠIČ

Časovna nihanja v velikosti domačega prašiča so bila bistveno bolj omejena kot pri domačem govedu in

of any statistically significant diachronic variation in sheep body-size (Mann-Whitney U test:  $U = 28,5$ ;  $Z = -1,35$ ;  $p = 0,177$ ; Fig. 8.22). This is further corroborated by the results of the inter-phase comparison in withers heights, estimated from the dimensions of astragali and calcanei. Even in this case the difference between Late Antiquity phases 1 and 2 are not statistically significant (Mann-Whitney U test:  $U = 15,5$ ;  $Z = 0,38$ ;  $p = 0,700$ ;  $N = 13$ ). There are only a few data available for the Early Medieval phase, but the existing material falls within the range seen in Late Antique sheep from the same site (Kruskal-Wallis ANOVA test:  $H [2, N = 27] = 2,06$ ;  $p = 0,356$ ).

drobnici (Riedel 1994, sl. 6d). Romanizacija jugovzhodnoalpskega prostora je sicer prispevala k izboljšanim pogojem reje tudi v primeru prašičev, kar je rezultiralo v dvigu povprečne višine ob vihru nasproti stanju v železni dobi. Drugače kot pri govedu in drobnici pa domači prašiči z rimskodobnih, poznoantičnih in zgodnjerednjeveških najdišč Srednje Evrope po velikosti niso nujno presegali prazgodovinskih, predvsem ne tistih bronastodobnih (Bökönyi 1974, 212 ss).

Ne glede na manj izrazita velikostna nihanja domačih prašičev v času pa primerjava standardiziranih dimenzij dolgih kosti omenjene vrste s Tonovcovega gradu, sočasnih najdišč iz severne Italije ter z Avstrijskega kaže razlike, ki presegajo mejo statistične značilnosti (test Kruskal-Wallis:  $H [2, N = 81] = 20,79; p = 0,000; sl. 8.23$ ). Izstopajo predvsem očitno manjši primerki s Tonovcovega gradu, medtem ko med gradivom iz severne Italije in z Avstrijskega statistično značilnih razlik nisva ugotovila.<sup>60</sup> V zvezi s slednjima dvema vzorcema velja pri tem dodati tudi to, da večjih odstopanj ne kažeta niti v primerjavi z rimskodobnimi primerki (sl. 8.23), kar potrjuje naše vedenje o relativno majhnih časovnih nihanjih v velikosti omenjene vrste. Drugače je pri prašičih s Tonovcovega gradu, ki so statistično značilno manjši od rimskodobnih primerkov iste vrste tako z Madžarskega (sl. 8.23) kot tudi s Slovenskega (Mann-Whitneyjev U-test:  $U = 333,5; Z = -3,36; p = 0,001$ ). Višina ob vihru za domačega prašiča s Tonovcovega gradu, ocenjena na podlagi dimenzij skočnic, niha med 60,8 in 74,2 cm (Me = 69,8; razpon: 60,8–74,2;  $N = 7$ ; cf. Teichert 1969) oz. med 60,8 in 64,8 cm (Me = 63,5; razpon: 60,8–64,8;  $N = 7$ ; cf. May *et al.* 1996).

Sodeč po sliki 8.23 torej domači prašiči na jugovzhodnoalpskem območju v pozni antiki niso tvorili metrično homogene populacije. Skladen s tem je podatek, da primerjava prašičjih ostankov s Tonovcovega gradu in s sočasnega najdišča Ajdovski Gradec nad Vranjem (Bartosiewicz, Choyke 1985) ni pokazala omembe vrednih razlik v njihovih dimenzijah, so pa zato eni in drugi statistično značilno manjši od ostankov iste vrste s prav tako poznoantične naselbine Tinje nad Loko pri Žusmu (Turk 2000).<sup>61</sup> V ugotovljeni heterogenosti se najverjetneje kaže različno razmerje med večjimi "rimskimi" in manjšimi lokalnimi prašiči v okviru razpoložljivih vzorcev (cf. Bökönyi 1974, 216), morda pa tudi različne

<sup>60</sup> Primerjava med prašiči s Tonovcovega gradu in s sočasnih najdišč v S Italiji: Mann-Whitneyjev U-test:  $U = 163,0; Z = -3,23; p = 0,001$ . Primerjava med gradivom s Tonovcovega gradu in s sočasnih najdišč iz Avstrije: Mann-Whitneyjev U-test:  $U = 171,0; Z = -3,97; p = 0,000$ . Med ostanki poznoantične starosti iz S Italije in z Avstrijskega statistično značilnih razlik nisva ugotovila (Mann-Whitneyjev U-test:  $U = 136,0; Z = -0,76; p = 0,445$ ).

<sup>61</sup> Primerjava med gradivom s Tonovcovega gradu in z Ajdovskega Gradca nad Vranjem: Mann-Whitneyjev U-test:  $U = 136,0; Z = 1,09; p = 0,274$ . Primerjava med gradivom s Tonovcovega gradu in s Tinja nad Loko pri Žusmu: Mann-Whitneyjev U-test:  $U = 102,5; Z = -2,67; p = 0,007$ .

### 8.5.3 PIG

Diachronic variation in pig body-size was not as great as observed in cattle and caprines (Riedel 1994, Fig. 6d). The improved conditions for pig husbandry brought to the region by the Romans did result in the rise of the average withers height when compared to the Iron Age. Nevertheless, the pigs from Roman period, Late Antique and Early Medieval sites in Central Europe were not necessarily superior in size to the prehistoric ones, especially not to those from the Bronze Age (Bökönyi 1974, 212 ff).

Regardless of the less pronounced diachronic variations in pig body-size, the comparison between the standardized measurements of suine long bones from Tonovcov grad and several contemporary sites in northern Italy and Austria show statistically significant differences (Kruskal-Wallis test:  $H [2, N = 81] = 20.79; p = 0.000; Fig. 8.23$ ). The markedly smaller specimens from Tonovcov grad clearly stand out, while the material from northern Italy and Austria show no statistically significant differences.<sup>62</sup> In relation to the latter two assemblages we should add that they do not show any major discrepancies relative to Roman period specimens (Fig. 8.23), thus confirming the thesis of relatively limited fluctuations in the size of the studied species through time. The pigs from Tonovcov grad show a different picture, for they are significantly smaller than those originating from Roman period sites (Tác/Gorsium: Fig. 8.23; Ribnica/Romula: Mann-Whitney U test:  $U = 333.5; Z = -3.36; p = 0.001$ ). The withers height of pigs from Tonovcov grad, estimated on the basis of the size of astragali, varies between either 60.8 and 74.2 cm (Me = 69.8, range: 60.8-74.2;  $N = 7$ ; cf. Teichert 1969) or between 60.8 and 64.8 cm (Me = 63.5, range: 60.8-64.8;  $N = 7$ ; cf. May *et al.* 1996), depending of the methodology used.

What follows from figure 8.23 is that pigs in the area of Southeastern Alps did not form a metrically homogeneous population during Late Antiquity. This is consistent with the fact that the comparison between pig remains from Tonovcov grad and from the contemporary settlement of Ajdovski Gradec above Vranje (Bartosiewicz, Choyke 1985) did not show any noteworthy differences in their sizes, however both are statistically significantly smaller than the remains from another Late Antique site in the broader region – Tinje above Loka pri Žusmu (Turk 2000).<sup>63</sup> The ob-

<sup>62</sup> The comparison between the pigs from Tonovcov grad and from sites in Northern Italy: Mann-Whitney U test:  $U = 163.0; Z = -3.23; p = 0.001$ . The comparison between the pigs from Tonovcov grad and from sites in Austria: Mann-Whitney U test:  $U = 171.0; Z = -3.97; p = 0.000$ . We have not found statistically significant differences between the Late Antique assemblages from Northern Italy and Austria (Mann-Whitney U test:  $U = 136.0; Z = -0.76; p = 0.445$ ).

<sup>63</sup> The comparison between the material from Tonovcov

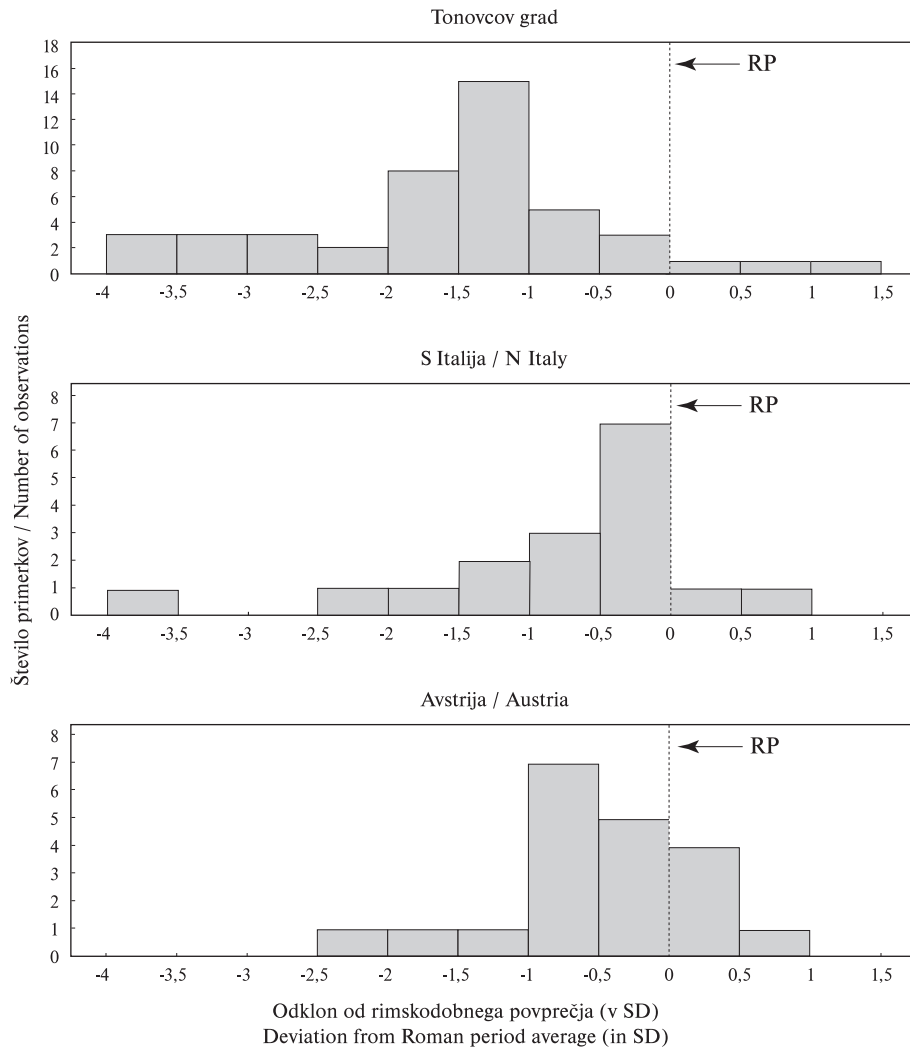

Sl. 8.23: Porazdelitev standardiziranih dimenzij dolgih kosti (nadlahtnica, koželjnica, golenica) ter skočnic domačega prašiča s Tonovcovega gradu ter z več sočasnih najdišč severne Italije in Avstrije. Vsak skeletni element je zastopan le s po eno dimenzijo. Postopek standardiziranja dimenzij je podan v pogl. 8.1. Legenda: RP – rimskodobno povprečje, izračunano na osnovi prašičjih ostankov iz rimskega mesta *Tác/Gorsium* (Madžarska; Bökönyi 1984). Seznam najdišč S Italije: Invillino (Stork, von den Driesch 1987); Monte Barro (Baker 1991); Videm/Udine: grad (Riedel 1993b); Verona: skupek VR-I (Riedel 1994a). Seznam najdišč Avstrije: Kappele (Pucher 1993); Teriola (Pucher 2003); Sveta Hema/Hemmaberg (Forstenpointner *et al.* 2002); Drösing (Riedel 2007). Fig. 8.23: Distribution of standardised metric data of pig long bones (humerus, radius, tibia) as well as astragali from Tonovcov grad and from a number of contemporary sites in Northern Italy and Austria. Each skeletal element is represented by a single measure. The procedure for standardising the metric data is given in chapter 8.1. Legend: RP – Roman Period average, calculated on the basis of pig remains from the Roman town of *Tác/Gorsium* (Hungary; Bökönyi 1984). The list of sites in N Italy: Invillino (Stork, von den Driesch 1987); Monte Barro (Baker 1991); Udine, castle (Riedel 1993b); Verona: complex VR-I (Riedel 1994a). List of sites in Austria: Kappele (Pucher 1993); Teriola (Pucher 2003); Hemmaberg (Forstenpointner *et al.* 2002); Drösing (Riedel 2007).

ekološke danosti posameznih okolij. Ker so razpoložljivi vzorci pogosto majhni (npr. Ajdovski gradec: N = 9; Tinje: N = 12), je ugotovljene razlike težko interpretirati. V primeru gradiva s Tonovcovega gradu pa se kljub vsemu zdi, da skromno število ostankov večjih "rimskih" prašičev (sl. 8.24) kaže na vsesplošno poslabšanje življenjskih razmer v obdobju pozne antike. Po drugi strani pa je tudi res, da so se na območjih zunaj Apeninskega polotoka celo v mirnejših časih od 1. do 4. stoletja večji prašiči množično pojavljali le v okviru gospodarskih posestev rimske poli-

served heterogeneity most likely reflects differential contributions by larger "Roman" and smaller local pigs to individual assemblages (*cf.* Bökönyi 1974, 216) and possibly also differing ecological characteristics of individual habitats. As these assemblages are often small (e.g. Ajdovski gradec: N = 9; Tinje: N = 12), the grad and Ajdovski Gradec above Vranje: Mann-Whitney U test: U = 136.0; Z = 1.09; p = 0.274. The comparison between the material from Tonovcov grad and Tinje above Loka pri Žusmu (Mann-Whitney U test: U = 102.5; Z = -2.67; p = 0.007).

Sl. 8.24: Grafični prikaz razmerja med največjo širino (Bd) in največjo globino (Dd) distalne epifize golenice domačega prašiča iz več različnih najdišč z območja današnje Slovenije. Seznam in velikost (N) vzorcev: Tonovcov grad (N = 13); Gornja Radgona (bronasta doba, N = 3); Veliki Vinji vrh (železna doba, N = 2); Cvinger (železna doba, N = 1); Grgar (železna doba, N = 1); Ig (železna doba, N = 1); Stična (železna doba, N = 10); Ribnica (rimska doba, N = 5); Školarice (rimska doba, N = 1); Pristava (zgodnji srednji vek, N = 1). Metrične podatke za najdišče Stična podaja Bökönyi (1994, 212), za Pristavo Toškan in Dirjec (2008, 150), preostanek pa predstavljajo lastni neobjavljeni podatki. Vse mere so v mm.

Fig. 8.24: Graphic representation of the relationship between the greatest breadth (Bd) and the greatest depth (Dd) of the tibial distal end in pigs from a number of sites in present-day Slovenia. List and size (N) of the samples: Tonovcov grad (N = 13); Gornja Radgona (Bronze Age, N = 3); Veliki Vinji vrh (Iron Age, N = 2); Cvinger (Iron Age, N = 1); Grgar (Iron Age, N = 1); Ig (Iron Age, N = 1); Stična (Iron Age, N = 10); Ribnica (Roman period, N = 5); Školarice (Roman period, N = 1); Pristava (Early Middle Ages, N = 1). The metric data for the site of Stična was provided by Bökönyi (1994, 212), for Pristava by Toškan and Dirjec (2008, 150), while the rest is represented by personal unpublished data. All measurements are in mm.

tične izbrane družbe (vila rustika), večjih mest in morda vojaških taborov (Bökönyi 1974, 216 s). Pri tem relativno velike dimenzije prazgodovinskih prašičev s slike 8.24 ne gre interpretirati kot dokaz za nadpovprečno dobre pogoje reje v navedenem obdobju, temveč kot rezultat bolj ali manj sistematičnega križanja z divjim prašičem. Ta praksa naj bi bila v času železne dobe v Srednji Evropi postopoma opuščena (Bökönyi 1974, 211 ss).

Analizo velikosti domačega prašiča s Tonovcovega gradu končujemo s primerjavo med gradivom iz obeh faz poznoantične poselitve (sl. 8.25). Omembe vrednih razlik nisva ugotovila, tako da o opaznejšem trendu spreminjanja velikosti živali v obdobju od konca 4. pa tja do začetka 7. stoletja na podlagi razpoložljivih podatkov ne moreva govoriti. Kot so pokazali rezultati statističnega testiranja, ni takšnih trendov zaznani niti ob hkratnem upoštevanju gradiva zgodnesrednjeveške starosti (Kruskal-Wallisova ANOVA:  $H [2, N = 42] = 5,25; p = 0,072$ ), za katero je značilno razmeroma skromno število najdb.

#### 8.5.4 KONJ

V primeru konja je razpoložljivih metričnih podatkov malo, zato poglobljene analize niso smiselne. Višino ob vihru je bilo mogoče oceniti le v primeru dveh metapodijev, ki pa sta verjetno pripadala isti živali. Obe kosti sta bili namreč najdeni neposredno druga poleg druge (kv./mkv. 719/D1; druga poznoantična faza), navrgli pa sta tudi zelo podobni oceni višine ob vihru, tj. med 133 in 139 cm (tab. 8.17). Navedeni konj<sup>62</sup> torej

<sup>62</sup> Da ne gre za mulo, je razvidno tako iz morfologije

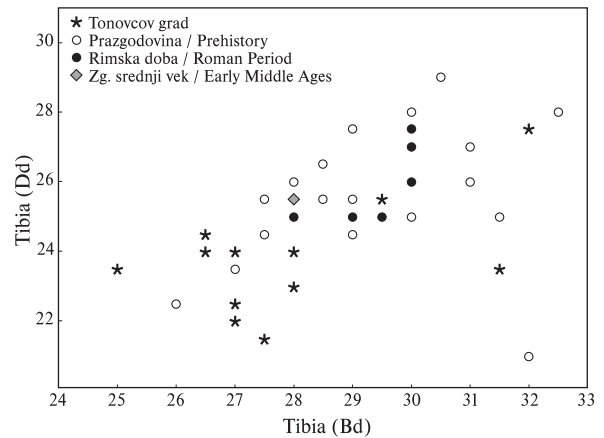

differences are not easy to interpret. Nevertheless, the modest numbers of the larger “Roman” pig remains in the much richer material from Tonovcov grad (N = 45) can be seen as being indicative of an overall deterioration in the living conditions in the Late Antique period (Fig. 8.24). On the other hand, it is also true that in the areas outside of the Apennine Peninsula – even in calmer times between the 1<sup>st</sup> and 4<sup>th</sup> century – larger pigs occurred in greater numbers only on larger estates owned by the Roman political elite (i.e. *villae rusticae*), main cities and possibly military camps (Bökönyi 1974, 216 f). At this the relatively large dimensions of the prehistoric pigs from figure 8.24 should not be interpreted as a reflection of above average husbandry conditions, but as a result of a more or less systematic crossbreeding with the wild boar. This practice was supposedly abandoned in Central Europe only during the Iron Age (Bökönyi 1974, 211 ff).

We conclude the study of the variations in pig body-size at Tonovcov grad with a comparison between the material from both Late Antiquity phases (Fig. 8.25). No substantial differences were discovered, thus the available data does not indicate any trend of changes in the animal size between the end of the 4<sup>th</sup> and the beginning of the 7<sup>th</sup> century. As shown by the results of the statistical testing no trends could be detected even when the Early Medieval material (with a relatively modest assemblage) was taken into account (Kruskal-Wallis ANOVA:  $H [2, N = 42] = 5,25; p = 0,072$ ).

#### 8.5.4 HORSE

In view of the limited number of measurements on horses at our disposal, no in-depth analysis was possible. Withers heights could be estimated only in the case of two metapodials, which most likely belonged to the same animal. Namely, the two bones were found next to each other (sq. 719; msq. D1, Late Antiquity phase 2), and they also yielded very similar estimates of withers height (i.e.

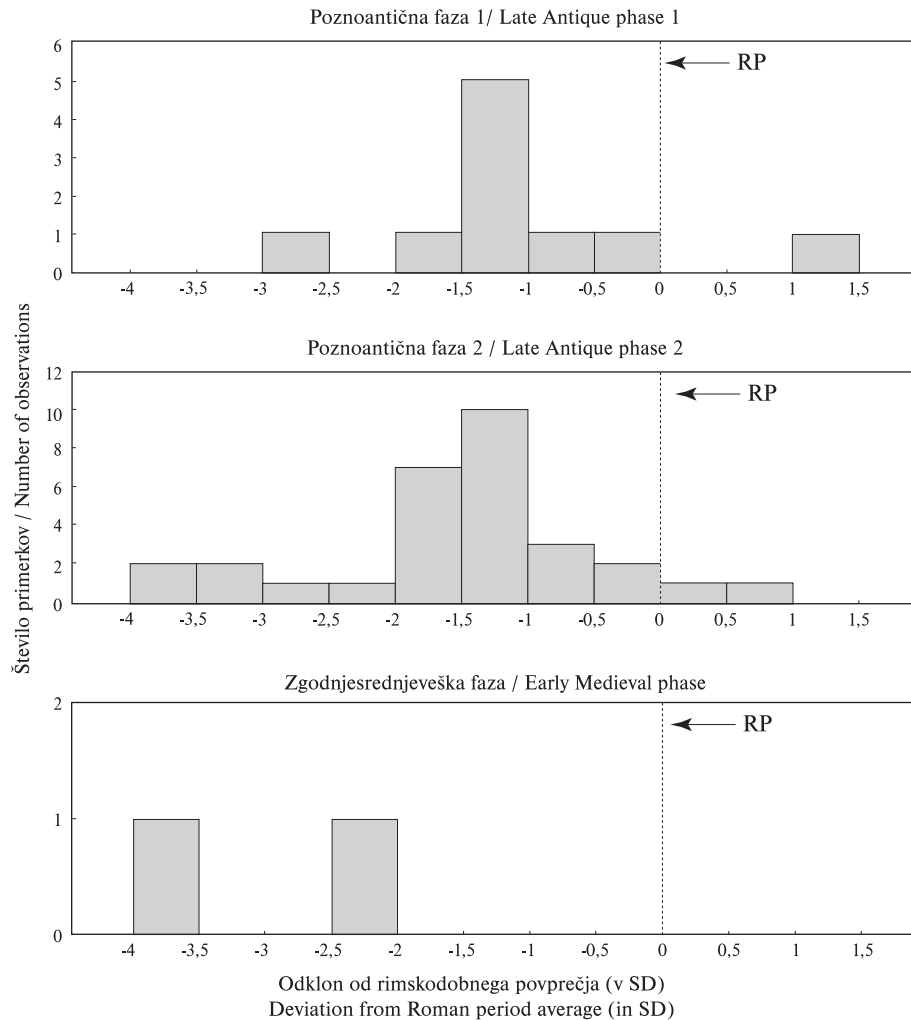

Sl. 8.25: Porazdelitev standardiziranih dimenzij dolgih kosti (nadlahtnica, koželjnica, golenica) ter skočnic domačega prašiča s Tonovcovega gradu po posameznih fazah. Vsak skeletni element je zastopan le s po eno dimenzijo. Postopek standardiziranja dimenzij je podan v pogl. 8.1. Legenda: RP – rimskodobno povprečje, izračunano na osnovi prašičjih ostankov iz rimskega mesta Tác/*Gorsium* (Madžarska; Bökönyi 1984).

Fig. 8.25: Distribution of standardised metric data of pig long bones (humerus, radius, tibia) as well as astragali from Tonovcov grad, by individual settlement phase. Each skeletal element is represented by a single measure. The procedure for standardising the metric data is given in chapter 8.1. Legend: RP – Roman Period average, calculated on the basis of pig remains from the Roman town of Tác/*Gorsium* (Hungary; Bökönyi 1984).

ni dosegal velikosti naprednih “rimskih” živali, katerih višina ob vihru se je gibala med 145 in 155 cm in ki so bile pogoste predvsem v vojaških utrdbah in na farmah tipa vila rustika (Bökönyi 1974, 263).

Zgornje rezultate potrjuje tudi neposredna primerjava dimenzij posameznih konjskih kosti med tukaj obravnavanim najdiščem in rimskodobnim mestom Tác/*Gorsium* (sl. 8.26). Čeprav so bili veliki “rimski” konji morda prisotni tudi na Tonovcovem gradu,<sup>63</sup> je moralo biti namreč njihovo število vseskozi zanemarljivo.

obeh kosti (cf. Peters 1998, 411) kot tudi iz vrednosti indeksa vitkosti (cf. Bökönyi 1984, 63 s); slednji v primeru dlančnice znaša 14,9, v primeru stopalnice pa 11,8.

<sup>63</sup> Glej npr. večjo od obeh skočnic na sliki 8.26.

between 133 and 139 cm; Tab. 8.17). This horse<sup>64</sup> therefore did not reach the size of the improved “Roman” form/breed whose withers heights varied between 145 and 155 cm, and whose bones were more commonly found within military forts and estates of the *villa rustica* type (Bökönyi 1974, 263).

These results were also confirmed by the direct comparison between the dimensions of individual horse bones from Tonovcov grad and those from the Ro-

<sup>64</sup> The morphology (cf. Peters 1998, 411) and the slenderness index (cf. Bökönyi 1984, 63 f) of the two bones clearly indicate that we are not dealing with a mule; the slenderness indices for the metacarpus/metatarsus were found to be 14.9/11.8.

Tab. 8.17: Višina ob vihru za konja s Tonovcovega gradu, ocenjena na osnovi velikosti dlančnice (Mc) oz. stopalnice (Mt) iz kvadranta 719 (mkv. D1; druga poznoantična faza). Višina ob vihru je bila izpeljana iz največje dolžine lateralne strani (GLL *sensu* von den Driesch 1976) s pomočjo Kiesewalterjevih koeficientov (ocena 1; *cf.* Riedel 1986, 137) ter iz največje dolžine (GL *sensu* von den Driesch 1976) dlančnice/stopalnice s pomočjo Vittovih koeficientov (ocena 2; *cf.* Vitt 1952). Vse mere so v mm.

Tab. 8.17: The estimate of the withers height for horse from Tonovcov grad, calculated on the basis of the greatest length of the lateral side (GLL *sensu* von den Driesch 1976) of the metacarpus (Mc)/metatarsus (Mt) from square 719 (msq. D1; Late Antiquity phase 2), using the Kiesewalter's coefficients (estimate 1; *cf.* Riedel 1986, 137) and the greatest length (GL *sensu* von den Driesch 1976) of the metacarpus /metatarsus using Vitt's coefficients (estimate 2; *cf.* Vitt 1952). All measurements are in mm.

Dimenzija / Dimension	Mc	Mt
GLL	217,0	253,0
Ocena 1 / Estimation 1	1391	1348
GL	218,0	257,0
Ocena 2 / Estimation 2	1330	1346

vo. To je razvidno iz dejstva, da se večina razpoložljivih ostankov umešča znotraj variacijske širine ustreznih dimenzij za velike (t. i. vzhodnoevropske *sensu* Bökönyi 1974, 250 ss) železnodobne konje z območja Srednje Evrope, katerih višina ob vihru je nihala med 120 in 150 cm (povprečna vrednost  $\approx$  137 cm; Bökönyi 1974, 252).

## 8.6 PALEOEKONOMIJA

Analiza deležev zastopanosti kosti iz bolj ali manj kvalitetnih kosov goveda, drobnice in prašiča je pokazala na določene razlike med posameznimi deli najdišča (sl. 8.11 in 8.14), ki jih je mogoče interpretirati kot dokaz socialne razslojenosti prebivalstva. Dodaten vpogled v to tematiko ter v paleoekonomsko sliko Tonovcovega gradu nasploh ponujajo podatki o frekvenci pojavljanja posameznih skeletnih elementov treh najbolj zastopanih taksonov po fazah (tab. 8.18).

Že bežen pogled na podatke iz tabele 8.18 kaže razmeroma skromno število drobnih kosti (npr. prstnice, zapestne in nartne kosti) nasproti večjim, kar lahko v veliki meri pripišemo pomanjkljivosti izbranega načina vzorčenja najdb (*cf.* Toškan, Dirjec 2004, 158 ss). Dejstvo namreč je, da je bil skozi sita presejan le manjši del izkopanega sedimenta, tako da je bila večina obravnavanih ostankov pobrana ročno med samim izkopavanjem. Tezo o vzročno-posledični povezavi med načinom vzorčenja in primanjkljajem

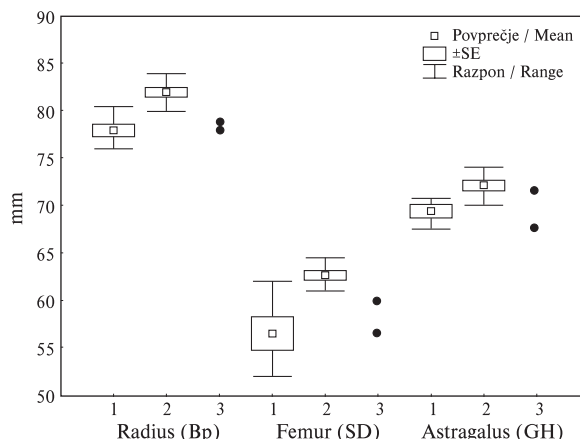

Sl. 8.26: Vrednosti nekaterih dimenzij ostankov konja s Tonovcovega gradu (vzorec 3). Za primerjavo so podani razponi vrednosti posamezne dimenzije pri železnodobnih konjih z najdišča Le Brustolade (vzorec 1; Riedel 1984) in rimskodobnih primerkov z najdišča Tác/Gorsium (vzorec 2; Bökönyi 1984). Legenda (*cf.* von den Driesch 1976): Bp – širina proksimalnega konca; Bd – širina distalnega konca, GH – največja višina.

Fig. 8.26: The value of certain dimensions of horse remains from Tonovcov grad (sample 3). For the sake of comparison we provided also the individual dimensions from Iron Age horses from the site of Le Brustolade (sample 1; Riedel 1984) and the Roman period specimens from the site of Tác/Gorsium (sample 2; Bökönyi 1984). Legend (*cf.* von den Driesch 1976): Bp – breadth of the proximal end; Bd – breadth of the distal end, GH – greatest height.

man site of Tác/Gorsium (Fig. 8.26). Even though large “Roman” horses might have been present at Tonovcov grad,<sup>65</sup> their numbers had to be negligible throughout the studied period. This can clearly be seen from the fact that most remains can be placed within the range for large (i.e. eastern group *sensu* Bökönyi 1974, 250 ff) Iron Age Central European horses, whose withers heights varied between 120 and 150 cm (average value  $\approx$  137 cm; Bökönyi 1974, 252).

## 8.6 PALEOECONOMY

The analysis of the abundance of bones from higher and lower quality carcass parts of cattle, sheep/goat and pig indicated certain differences between the individual locations within the studied site (Figs. 8.11 and 8.14). These differences may be seen as a reflection of the social diversity of the population. An additional insight into this issue and into the paleoeconomy of Tonovcov grad is offered by the frequencies of skeletal elements of the three best represented taxa per phase (Tab. 8.18).

A brief glance at the data from table 8.18 shows a relatively low number of small bones (e.g. phalanges, carpals, tarsals) compared to larger ones. To a certain extent

<sup>65</sup> See for instance the larger of the two astragali in Fig. 8.26.

drobnih kosti podkrepljuje ugotovitev, da v gradivu s Tonovcovega gradu število prvih prstnic drobnice očitno presega število drugih (*tab. 8.19*). Ker ni verjetno, da bi bila oba skeletna elementa med raztelesenjem živali ločena, spričo razmeroma podobne strukturne gostote (*cf. Lyman 1999, Tab. 7.6*) pa tudi ne gre pričakovati razlik v njuni obstojnosti, se zdi primanjkljaj drugih prstnic utemeljeno razložiti z razliko v njuni velikosti (druga prstnica je manjša). V zvezi s tem je povedno, da podobne razlike v številu nekajkrat večjih prvih in drugih prstnic pri govedu ni opaziti (*tab. 8.19*).

Navkljub ugotovljenemu primanjkljaju prstnic, zapestnih in nartnih ter drugih razmeroma majhnih kosti (npr. pogačic), kar je še posebej očitno v primeru telesno relativno majhne drobnice (*tab. 8.18–8.19*), pa v gradivu s Tonovcovega gradu podobnega primanjkljaja še celo nekoliko manjših zob ni zaznati (*tab. 8.18*). Celo več. V okviru ostankov iz prve poznoantične poselitvene faze predstavljajo (pretežno izolirani) zobje ovac in koz

this can be explained with the shortcomings of the chosen sampling method (*cf. Toškan, Dirjec 2004, 157 ff*); as only a minor part of the excavated sediment was sieved most of the analyzed remains were picked up manually during the excavation. Consequently, isolated teeth and small bones as well as smaller bone fragments were often overlooked and thus not collected. This is in a way corroborated by the greater number of first than second caprine phalanges in the material from Tonovcov grad (*Tab. 8.19*). As it is unlikely that these two skeletal elements were separated when the animal was butchered, and as – taking into account the relatively similar structural density (*cf. Lyman 1999, Tab. 7.6*) – both are expected to preserve in the sediment equally well, the lack of second phalanges can be explained by their much smaller size. Unsurprisingly, no substantial differences in the numbers of much larger first and second cattle phalanges were observed (*Tab. 8.19*).

Contrary to the paucity of phalanges, carpals, tarsals and other relatively small bones (e.g. kneecaps), which is

*Tab. 8.18: Zastopanost posameznih skeletnih elementov domačega goveda, drobnice in prašiča s Tonovcovega gradu po fazah. Legenda: PA – poznoantična faza; ZSV – zgodnesrednjeveška faza.*

*Tab. 8.18: Representation of individual skeletal elements of cattle, sheep/goats and pigs from Tonovcov grad per phase. Legend: LA – Late Antiquity phase; EMA – Early Medieval phase.*

Skelet. element	PA 1 / LA 1			PA 2 / LA 2			ZSV / EMA		
	Bos	Capr.	Sus	Bos	Capr.	Sus	Bos	Capr.	Sus
Proc. corn.	12	15	–	14	21	–	–	16	–
Cranium	7	3	3	6	8	27	–	2	1
Maxilla	2	1	14	3	4	24	–	1	5
Mandibula	48	35	39	19	88	65	3	11	6
Dentes	106	293	50	83	428	84	22	54	17
Vertebrae	60	21	4	57	39	33	9	10	7
Scapula	19	17	14	15	40	56	1	12	7
Humerus	28	27	23	22	70	36	6	22	3
Radius	37	53	12	31	116	18	2	22	3
Ulna	27	8	20	16	21	29	1	5	4
Carpalia	17	1	–	9	4	–	3	2	–
Metacarp.	18	25	4	22	35	14	2	12	1
Phalanx 1	28	7	3	21	19	8	4	9	–
Phalanx 2	25	1	2	17	7	7	2	2	1
Phalanx 3	16	1	1	7	5	1	–	5	2
Pelvis	35	26	15	27	28	29	10	12	2
Sacrum	3	–	1	–	1	3	–	2	–
Femur	36	15	7	24	38	7	3	8	4
Patella	8	–	2	1	1	1	1	–	–
Tibia	31	47	25	25	80	26	5	16	3
Fibula	–	–	–	–	–	2	–	–	–
Tarsalia	49	19	5	25	29	17	1	5	2
Metatars.	30	23	3	22	41	9	7	2	2
Σ	642	638	251	468	1124	496	80	230	70

Tab. 8.19: Število prvih in drugih prstnic drobnice in domačega goveda s Tonovcovega gradu po fazah. Legenda: PA – poznoantična faza; ZSV – zgodnj srednjeveška faza.

Tab. 8.19: Number of first and second phalanges of sheep/goats and cattle from Tonovcov grad per phase. Legend: LA – Late Antiquity phase; EMA – Early Medieval phase.

Takson Taxon	Skelet. element	PA 1 LA 1	PA 2 LA 2	ZSV EMA
Caprinae	Phalanx 1	7	19	9
	Phalanx 2	1	7	2
Bos	Phalanx 1	28	21	4
	Phalanx 2	25	17	2

slabo polovico (tj. 45,9 %) vseh najdb omenjenih dveh vrst.<sup>64</sup> Med gradivom, datiranim v drugo poznoantično oz. zgodnj srednjeveško fazo, je delež zob med ostanki drobnice sicer nekoliko manjši (tj. 38,1 % oz. 23,5 %), vendar pa ta še vedno (bistveneje) ne zaostaja za deležem zob med ostanki goveda (17,7 % oz. 27,3 %) oz. prašiča (17,9 % oz. 24,3 %). Če ob tem upoštevamo, da je bilo med ročnim pobiranjem najdb najverjetneje spregledanih več razmeroma majhnih izoliranih zob ovac in koz nasproti bistveno večjim primerkom goveda in prašiča, je zgornja ugotovitev še toliko bolj zanimiva. Navedeni podatki nedvoumno kažejo na to, da ugotovljene razlike v zastopanosti posameznih skeletnih elementov med gradivom s Tonovcovega gradu ni utemeljeno pripisati zgolj dejanskim razlikam v številu posameznih skeletnih elementov v okviru okostij posameznih kopitarjev ali pa napakam zavoljo izbranega načina vzorčenja najdb. Ustrezno pozornost si namreč zasluži tudi cel spekter biotskih in abiotskih poodložitenih dejavnikov.

Z vidika vpogleda v ekonomijo skupnosti je seveda zanimiv predvsem podatek, v kolikšni meri so v frekvenci zastopanosti posameznih skeletnih elementov kopitarjev izražene aktivnosti človeka. V zvezi s tem je tako treba poudariti, da je zgoraj izpostavljen podatek o skoraj polovičnem deležu zastopanosti zob (in torej posredno obeh<sup>65</sup> čeljustnic) med vsemi ostanki drobnice iz prve poznoantične faze razviden le v primeru, da abundanco izrazimo kot število določenih primerkov (NISP; sl. 8.27). Če namreč kot kazalnik številčnosti skeletnih elementov drobnice uporabimo podatek o najmanjšem številu osebkov (MNI) in s tem do neke mere upoštevamo očitno razliko v številu zob v okviru skeleta ovac/koz nasproti številu drugih elementov, potem delež zastopanosti čeljustnic ni več izstopajoč (sl. 8.28). Nasprotno. Upošteva je podatke s slike 8.28 se

<sup>64</sup> Med najdbami domačega goveda iz prve poznoantične faze je zob le 16,5 odstotka, med prašičji pa 19,9 odstotka.

<sup>65</sup> Število zgornjih zob ne odstopa bistveno od števila spodnjih v nobeni od treh tukaj obravnavanih faz (poznoantična faza 1: 97 nasproti 104; poznoantična faza 2: 180 nasproti 208; zgodnj srednjeveška faza: 14 nasproti 16).

especially evident in the case of the physically relatively small caprines (Tabs. 8.18-8.19), no such shortage has been seen in the case of teeth (Tab. 8.18). Moreover, in the material from the Late Antiquity phase the (mostly isolated) sheep and goat teeth represent almost half (i.e. 45.9 %) of all finds ascribed to these two species vs. a mere 16.5 % in cattle and 19.9 % in pigs. In the material from Late Antiquity phases 2 and the Early Medieval phase the contribution of teeth to all caprine remains is somewhat smaller (i.e. 38.1 % and 23.5 %, respectively), however it still stays at least at the level of cattle (17.7 % and 27.3 %, respectively) or pig finds (17.9 % and 24.3 %, respectively). If we take into account the fact that during the hand picking of the finds it was highly likely that many relatively small isolated sheep and goat teeth were overlooked, this observation is even more intriguing. This undoubtedly indicates that the detected discrepancies in the frequencies of individual skeletal elements in the material from Tonovcov grad cannot be ascribed merely to the actual differences in the numbers of these skeletal elements within the ungulate skeleton or the errors that occurred due to the size-selective sampling methodology. The entire spectrum of biotic and abiotic post-depositional factors also played their role.

The almost 50 % share of teeth (and thus indirectly of both jawbones)<sup>66</sup> among all caprine remains from Late Antiquity phase 1 is observable only when abundance is expressed in terms of the Number of Identifiable specimens (NISP; Fig. 8.27). If we use the Minimum Number of Individuals (MNI) instead, thus taking into account the obvious difference in the number of teeth in the sheep/goat skeleton compared to the numbers of most of the other elements, then the contribution of mandibles and maxillae no longer stands out (Fig. 8.28). On the contrary! Taking into account the data from figure 8.28 it seems that in the caprine material from the Late Antiquity phase 1 of Tonovcov grad cranial skeletal elements are not as common as e.g. radii or tibiae. Although the difference is not statistically significant ( $\chi^2 = 0.95$ ;  $p = 0.327$ ).

It can be concluded that individual sheep/goat skeletal elements from Tonovcov grad reflect human activities (see for instance chapter 8.3.1), for otherwise the larger structural density of teeth would have to result in their numbers being greater relative to most bones irrespective of the indicator chosen (i.e. either NISP or MNI). A similar conclusion can be derived from the differences observed in the number of fused epiphyses of sheep/goat bones linked by similar structural density ( $\approx$  similar preservability in the sediments; Tab. 8.20). Finally, the data from table 8.20 indicate another interesting detail: the ratio between the number

<sup>66</sup> The number of upper teeth does not differ greatly from the number of lower teeth in any of the three phases (Late Antiquity phase 1: 97 vs. 104; Late Antiquity phase 2: 180 vs. 208; Early Medieval phase 3: 14 vs. 16).



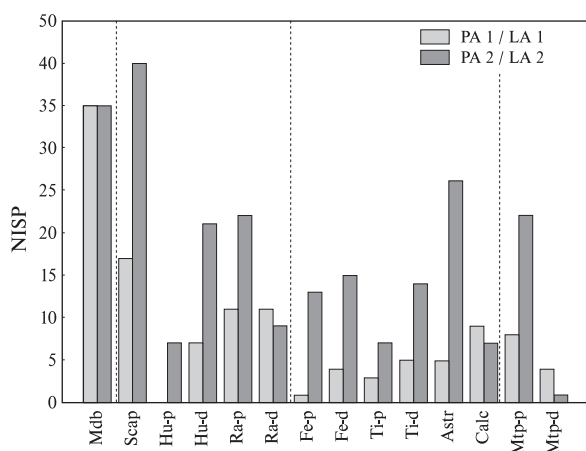

Sl. 8.27: Zastopnost ostankov posameznih (delov) skeletnih elementov drobnice med gradivom iz prve in druge poznoantične poselitvene faze (= PA) Tonovcovega gradu. Abundanca najdb je izražena kot število določenih primerkov (NISP). Legenda: p – proksimalni del; d – distalni del. Med ostanke spodnje čeljustnice so prišteti tudi vsi izolirani spodnji sekalci, ličniki in kočniki.

Fig. 8.27: Representation of individual sheep and goat skeletal elements within the material from the Late Antiquity phases (= LA) 1 and 2 at Tonovcov grad. The abundance of finds is expressed as the number of identifiable specimens (NISP). Legend: p – proximal part; d – distal part. Isolated lower incisors and (pre)molars are included among the remains of mandibles.

celo zdi, da so kosti glave ovac in koz v gradivu iz prve faze poznoantične poselitve Tonovcovega gradu slabše zastopane od npr. koželjnic ali golenic, čeprav razlika sicer ni statistično značilna (test  $\chi^2$ :  $\chi^2 = 0,95$ ;  $p = 0,327$ ).

Iz zgornjega izhaja, da se v zastopnosti posameznih skeletnih elementov (drobnice) s Tonovcovega gradu do neke mere zagotovo odražajo tudi človekove aktivnosti (glej npr. pogl. 8.3.1), saj bi morali biti zobje spričo njihove večje strukturne gostote sicer številčnejše zastopani od kosti tudi, če bi bila abundanca najdb izražena kot MNI. Enak sklep je mogoče izpeljati iz razlik v frekvenci zastopnosti epifiz posameznih ovčjih/kozjih kosti s podobno strukturno gostoto, katerih obstojnost v sedimentu je torej načeloma primerljiva (tab. 8.20). Ne nazadnje pa podatki iz tabele 8.20 kažejo na še eno prav tako zelo povedno zanimivost: razmerje med številom epifiz dolgih kosti prednjih<sup>66</sup> in zadnjih nog v gradivu iz prve poznoantične faze namreč statistično značilno odstopa od dejanskega razmerja med abundanco obeh skupin kosti v okviru skeleta drobnice (test  $\chi^2$ :  $\chi^2 = 10,12$ ;  $p < 0,01$ ), kar nakazuje razlike v človekovem procesiranju posameznih delov trupa. Podobno nesorazmerje obstaja tudi med številom kosti iz najbolj (tj. nadlahtnice, stegnenice) in najmanj (tj. dlančnice, stopalnice) mesnatih

<sup>66</sup> Abundanca epifiz koželjnice je izražena kot povprečje med številom ostankov proksimalne in distalne epifize omenjenega skeletnega elementa.

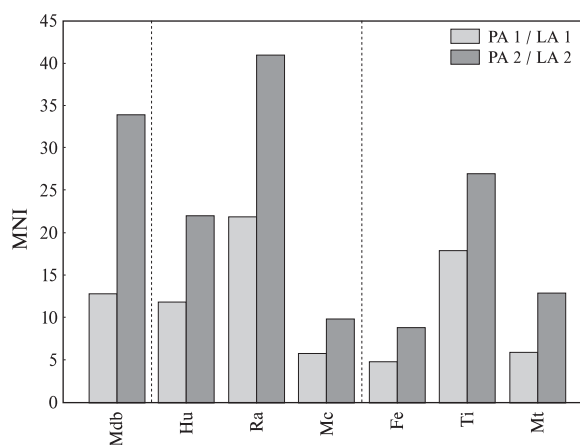

Sl. 8.28: Zastopnost ostankov posameznih skeletnih elementov drobnice med gradivom iz prve in druge poznoantične poselitvene faze (= PA) Tonovcovega gradu. Abundanca najdb je izražena kot najmanjše število osebkov (MNI). Legenda: p – proksimalni del; d – distalni del. Med ostanke spodnje čeljustnice so prišteti tudi vsi izolirani spodnji sekalci, ličniki in kočniki.

Fig. 8.28: Representation of individual sheep and goat skeletal elements within the material from the Late Antiquity phases (= LA) 1 and 2 at Tonovcov grad. The abundance of finds is expressed as the minimum number of individuals (MNI). Legend: p – proximal part; d – distal part. Isolated lower incisors and (pre)molars are included among the remains of mandibles.

of caprine long bone epiphyses from front<sup>67</sup> and hind limbs found in the material from Late Antiquity phase 1 is significantly different from the one dated to the Late Antiquity phase 2 ( $\chi^2 = 10,12$ ;  $p < 0,01$ ). This is indicative of the differential processing of individual body parts. A similar disproportion also exists amongst the numbers of bones from the most (i.e. humerus, femur) and least (i.e. metacarpus, metatarsus) meaty parts of both pairs of extremities within the finds dated to Late Antiquity phase 2 ( $\chi^2$  test:  $\chi^2 = 28,44$ ;  $p < 0,001$ ).

If figure 8.28 is indeed indicative of the influence of human activities on the representation of individual skeletal elements, then differences between the abundance of teeth and the abundance of jawbone fragments indicates a no less important role of various post-depositional factors. Regardless of the abundance indicator (i.e. NISP or MNI) the number of sheep/goat teeth by far surpasses the abundance of jawbones within the material from both Late Antiquity phases (Tab. 8.18). In view of the very similar horizontal distribution of skeletal elements the discrepancy observed in the quantity of teeth relative to maxillae/mandibles might be explained by the poorer resistance of the latter to dog (pig?) ravaging and/or disintegration in the sediment. As it can be seen in table 8.21, several local concentrations of teeth have been observed.

<sup>67</sup> The abundance of radius epiphyses is expressed as the average between the number of remains of the proximal and distal epiphyses.

Tab. 8.20: Število ostankov epifiz posameznih skeletnih elementov drobnice s Tonovcovega gradu, ki izkazujejo primerljivo (tj. med 0,500 in 0,700 g/cm<sup>3</sup>) strukturno gostoto. Abundanca najdb je izražena kot število določenih primerkov (NISP). Podatke o strukturni gostoti podajajo Lam *et al.* (1998, Tab. 1). Legenda: PA – poznoantična faza; ZSV – zgodnesrednjeveška faza. Tab. 8.20: Number of sheep/goat epiphysis remains from individual skeletal elements, which show a comparable (i.e. between 0.500 and 0.700 g/cm<sup>3</sup>) structural density. The abundance of finds is expressed as the number of identifiable specimens (NISP). The data on structural density is provided by Lam *et al.* (1998, Tab. 1). Legend: LA – Late Antiquity phase; EMA – Early Medieval phase.

Skelet. element	PA 1 LA 1	PA 2 LA 2	ZSV EMA
Humerus (dist.)	7	21	10
Radius (prox.)	11	22	5
Radius (dist.)	11	9	3
Metacarpus (dist.)	7	1	2
Femur (prox.)	1	13	2
Tibia (dist.)	5	14	7
Metatarsus (dist.)	1	1	1

delov obeh parov okončin za najdbe drobnice iz druge poznoantične faze (test  $\chi^2$ :  $\chi^2 = 28,44$ ;  $p < 0,001$ ).

Če je mogoče razliko med abundanco zob in nekaterih dolgih kosti na *sliki* 8.28 razumeti kot argument v prid tezi o pomembnem vplivu človekovih aktivnosti na ugotovljeno zastopanost posameznih skeletnih delov drobnice s Tonovcovega gradu, pa razlika med abundanco zob in abundanco fragmentov čeljustnic priča o prav tako pomembni vlogi različnih poodložitvenih dejavnikov. Ne glede na izbrani način izražanja številčnosti najdb (tj. NISP ali MNI) namreč abundanca zob drobnice močno presega abundanco čeljustnic tako v okviru gradiva iz prve kot tudi iz druge faze poznoantične poselitve obravnavanega najdišča (*tab.* 8.18). Da gre navedeno razliko domnevno res pripisati slabšemu kljubovanju čeljustnic destruktivni aktivnosti psov (prašičev?) in/ali razpadanju v sedimentu, je pokazala podobnost med vzorcema porazdelitve najdb obeh obravnavanih skeletnih elementov v prostoru. Kot je razvidno iz *tabele* 8.21, izkazujejo zobje nekaj očitnih koncentracij najdb. Tako je bila v primeru gradiva iz prve poznoantične faze kar dobra petina zob pobrana iz le štirih mikrokvadrantov skupne površine zgolj 4 m<sup>2</sup>, v gradivu iz druge poznoantične faze pa je bil ta delež le malenkost nižji. Pri tem je povedno, da je na istih mestih tudi podobna relativna koncentracija ostankov spodnjih in zgornjih čeljustnic; na območju kvadrantov z izrazito številčno prisotnostjo zob ter v njihovi neposredni okolici<sup>67</sup> je bila namreč pobrana kar tretjina vseh najdb čeljustnic (*tab.* 8.21). V manjši absolutni abundanci najdb čeljustnic nasproti zobem je tako najverjetneje izražena prav njihova večja tafonomska izguba v poodložitvenem obdobju (glej tudi pogl 8.3.1).

Ne glede na težavno razlikovanje med posledicami človekove aktivnosti in rezultati delovanja posameznih poodložitvenih dejavnikov na ugotovljene frekvence zastopanosti posameznih skeletnih elementov kopitarjev sva v okviru študije ekonomije poznoantične skupnosti s Tonovcovega gradu analizirala tudi delež zastopanosti ostankov različnih kvaliteten delov trupa goveda

<sup>67</sup> Neposredno okolico posameznega mikrokvadranta predstavlja osem nanj mejnih mikrokvadrantov.

For instance, in the case of Late Antiquity phase 1 the over one fifth of the sheep/goat teeth were collected from four microsquares measuring a mere 4 m<sup>2</sup> in total, and with Late Antiquity phase 2 this share was only slightly lower. At this point it is important that in the same areas a relatively similar concentration of the remains of lower and upper jawbones has been observed; as much as one third of all mandibles and maxillas were discovered in the area of the squares with a numerically strong presence of teeth and in their immediate surroundings<sup>68</sup> (*Tab.* 8.21). The smaller absolute abundances of jawbone finds (compared to tooth finds) thus most likely reflect their greater taphonomic loss (see also chapter 8.3.1).

Regardless of the difficulty in distinguishing between the consequences of human activity and the results of various other post-depositional factors upon the observed frequencies of individual ungulate skeletal elements we have – within the framework of the economy of the Late Antiquity community at Tononcov grad – also analysed the frequency of carcass parts of different qualities for cattle (*Fig.* 8.29) and sheep/goat (*Fig.* 8.30) within the individual squares in the broader area of building 1. In the event that the results showed groupings of individual squares based on settlement phases this could be understood as a reflection of the existence of actual differences between the phases in the shares of the skeletal elements from individual qualitative carcass categories. With the intent of reducing the disruptive influence of the small samples upon reliability, only squares including at least 40 taxonomically identified mammalian bones and teeth per any of the three phases were included in the analysis.

As far as the results for cattle, the heterogeneity in the group of samples<sup>69</sup> with relatively small numbers of finds is significantly larger than the one found in richer samples (*Fig.* 8.29). Consequently, the conclusions based on small samples is at least in this case unreliable. However, it is interesting that a certain gap between the material from Late Antiquity phases 1 and 2 is shown even

<sup>68</sup> The immediate surroundings of an individual microsquare are represented by the eight microsquares that border it.

<sup>69</sup> A *sample* is defined as the remains from an individual settlement phase originating from an individual square.

Tab. 8.21: Abundanca zob drobnice v okviru štirih z omenjenimi najdbami najbolj bogatih mikrokvadrantov za vsako od obeh poznoantičnih poselitvenih faz (= PA) Tonovcovega gradu. Podana je tudi abundanca ostankov spodnjih in zgornjih čeljustnic v istih mikrokvadrantih ter v njihovi neposredni okolici; neposredno okolico posameznega mikrokvadranta predstavlja osem nanj mejajočih mikrokvadrantov.

Tab. 8.21: The abundance of sheep/goat teeth within the frame of the four richest micro-quadrants for each of the two Late Antiquity phases (= LA) at Tononcov grad. Given is also the abundance of the remains of the upper and lower jawbones in the same micro-squares and in their vicinity; the vicinity of an individual micro-square is represented by the eight bordering micro-squares.

Faza Phase	Kv. (Mkv.) Sq. (Msq.)	Št. zob v mkv. N of teeth in msq.	Št. čeljustnic v mkv. in njegovi okolici N of maxillas & mandibles in msq. and its surroundings
PA 1	666 (A2)	14	3
	769 (A2)	18	7
	817 (D3)	16	3
LA 1	818 (A3)	15	–
	Σ	63 (=21,5 % Tot.)	13 (=36,2 % Tot.)
PA 2	666 (A2)	14	6
	669 (C3)	26	8
	716 (A3)	12	6
LA 2	769 (A1)	24	11
	Σ	79 (=17,8 % Tot.)	31 (=33,6 % Tot.)

(sl. 8.29) in drobnice (sl. 8.30) po posameznih kvadrantih na območju stavbe 1. V kolikor bi rezultati izpostavili grupacije posameznih kvadrantov na osnovi poselitvenih faz, bi to lahko razumeli kot potrditev teze o obstoju dejanskih medfaznih razlik v deležu zastopanosti skeletnih elementov posamezne kvalitetne kategorije trupa. Z namenom zmanjšati moteč vpliv (pre)majhnih vzorcev na zanesljivost rezultatov sva v analizo vključila le tiste kvadrante, v katerih je bilo med gradivom katere od treh faz pobranih najmanj 40 določljivih sesalskih kosti in zob.

V zvezi z rezultati za domače govedo velja v prvi vrsti izpostaviti, da je heterogenost v skupini vzorcev z razmeroma majhnim številom najdb bistveno večja od stanja v bogatejših vzorcih (sl. 8.29). Iz tega izhaja, da je ocena deležev zastopanosti skeletnih elementov različnih kvalitetnih kategorij trupa, utemeljena na majhnih vzorcih, vsaj v tem primeru pač nezanesljiva. Je pa zato toliko bolj zanimiva ugotovitev, da se določena razlika med gradivom iz obeh poznoantičnih faz kaže tudi ob upoštevanju le najbogatejših vzorcev (tj. tistih z NISP > 30). Prekrivanje med obema skupinama je sicer veliko, a vzorci z gradivom iz druge poselitvene faze vendarle kažejo na v povprečju nekoliko večji delež ostankov najbolj kvalitetnih delov goveda.<sup>68</sup>

V tem smislu podobno sliko ponujajo tudi rezultati za drobnico (sl. 8.30). Tudi ob pogledu na sliko 8.30 namreč lega vzorcev z najdbami iz druge poznoantične faze nakazuje v povprečju nekoliko večji delež zastopanosti ostankov lopatic, nadlahtnic, vretenc, medenic in stegenic v omenjenem gradivu, kot je bilo to

<sup>68</sup> Podatki za zgodnesrednjeveško fazo v tej primerjavi niso bili upoštevani, saj je razpoložljivo število vzorcev preskromno.

when only the richest samples are taken into account (i.e. those with N > 30). Although the overlap between the two groups is large, the assemblages from the Late Antiquity phase 2 show a slightly higher contribution of remains from the meatiest parts.<sup>70</sup>

A similar picture is offered by the results for caprines (Fig. 8.30), as the finds from the Late Antiquity phase 2 show a slightly higher share of scapula, humerus, vertebrae, pelvis and femur remains relative to the material from the Late Antiquity phase 1. As opposed to cattle, in the case of sheep and goats the results do not change significantly even when smaller samples (less than 25 remains) are taken into account.

In order to expand upon these results we compared the 13 richest faunal assemblages (NISP > 90) using the Multidimensional Scaling (StatSoft, Inc. 2001). The input matrix used in the estimation of assemblage-assemblage similarities included data on the number of all taxonomically identified mammalian remains, the number of cattle, caprine, pig, horse and game remains, as well as the abundance of bones from the three meat quality categories of the cattle and caprine carcass. A satisfactorily high proportion of variance of the initial data set was accounted for by the first three multidimensional scaling dimensions (stress = 0.07). Nevertheless, statistically significant inter-phase differences were observed only in dimension 1 (Mann-Whitney U test: U = 0.00; Z = 2.88; p = 0.004). Namely, the assemblages from the Late Antiquity phase 2 are placed in the left side of the diagram, while assemblages from the Late Antiquity

<sup>70</sup> In this comparison data for the Early Medieval phase was not taken into account, for the number of sufficiently large samples was too small.

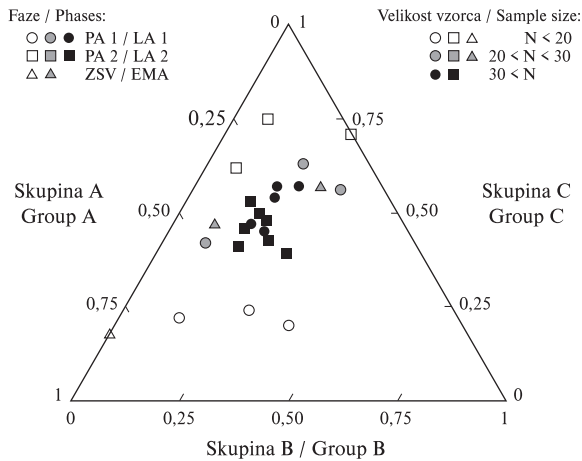

Sl. 8.29: Delež zastopanosti ostankov iz posamezne od treh kvalitetnih kategorij (tj. kategorija A, B in C) trupa domačega goveda po kvadrantih na Tonovcovem gradu: območje stavbe 1. Upoštevani so le kvadranti, v okviru katerih je bilo med gradivom katere od poselitvenih faz najdenih najmanj 40 določljivih sesalskih kosti in zob. Vzorec porazdelitve skeletnih elementov v omenjene kvalitetne kategorije je podan v pogl. 8.1. Legenda: PA – poznoantična faza; ZSV – zgodnj srednjeveška faza.

Fig. 8.29: The share of the remains of each of the three qualitative categories (i.e. category A, B and C) of the carcass of cattle, by squares in the area of building 1. Only squares providing at least 40 taxonomically determined mammalian bones and teeth per any of the three settlement phases were taken into account. The division of skeletal elements into qualitative categories A, B and C is shown in chapter 8.1. Legend: LA – Late Antiquity phase; EMA – Early Medieval phase.

ugotovljeno za vzorce z najdbami iz prve poznoantične poselitvene faze. Za razliko od domačega goveda pa se v primeru drobnice rezultati bistveno ne spremenijo niti ob upoštevanju manjših vzorcev s skupnim številom določenih sesalskih ostankov pod 25.

Zgornje rezultate sva nadgradila z uporabo metode večdimenzionalnega skaliranja (*Multidimensional Scaling*). Pri tem sva vzporejala 13 s favnističnimi najdbami najbogatejših vzorcev (NISP > 90), in sicer s hkratnim upoštevanjem podatkov o številu vseh določenih sesalskih ostankov, številom ostankov domačega goveda, drobnice, prašiča, konja in vseh lovnih vrst ter številom kosti iz treh kvalitetnih kategorij trupa goveda in drobnice. Matriko razlikovnosti, sestavljeno na podlagi navedenih podatkov, sva razložila s pomočjo treh dimenzij (stres = 0,07), pri čemer so medfazne razlike v vrednostih posameznih dimenzij mejo statistične značilnosti presegale le v primeru dimenzije 1 (Mann-Whitneyjev U-test:  $U = 0,00$ ;  $Z = 2,88$ ;  $p = 0,004$ ). Kot je razvidno s slike 8.31, se namreč vzorci z gradivom iz druge poznoantične poselitvene faze Tonovcovega gradu umeščajo v levo polovico diagrama, tisti z ostanki iz prve pa v desno. Takšno porazdelitev je mogoče razložiti prav z razliko v deležu zastopanosti kosti iz najbolj kvalitetnih delov

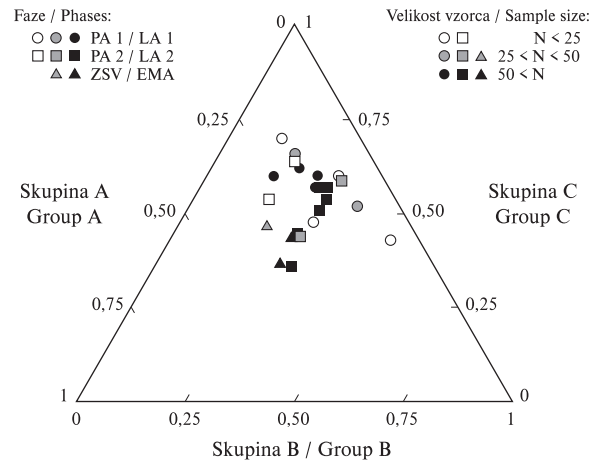

Sl. 8.30: Delež zastopanosti ostankov iz posamezne od treh kvalitetnih kategorij (tj. kategorija A, B in C) trupa drobnice po kvadrantih na Tonovcovem gradu: območje stavbe 1. Upoštevani so le kvadranti, v okviru katerih je bilo med gradivom katere od poselitvenih faz najdenih najmanj 40 določljivih sesalskih kosti in zob. Vzorec porazdelitve skeletnih elementov v omenjene kvalitetne kategorije je podan v pogl. 8.1. Legenda: PA – poznoantična faza; ZSV – zgodnj srednjeveška faza.

Fig. 8.30: The share of the remains of each of the three qualitative categories (i.e. category A, B and C) of the carcass of sheep/goats, by squares in the area of building 1. Only squares providing at least 40 taxonomically determined mammalian bones and teeth per any of the three settlement phases were taken into account. The division of skeletal elements into qualitative categories A, B and C is shown in chapter 8.1. Legend: LA – Late Antiquity phase; EMA – Early Medieval phase.

phase 1 can be found on the right (Fig. 8.31). Such a distribution might reflect the difference in the share of bones from the parts of the carcass richest in meat, as it indicates a gradual decline in the value along the abscise axis (= dimension 1) both in the case of cattle and caprines. The sheep and goat remains show a similar trend also along the ordinate axis (= dimension 2), but here the differences between Late Antiquity phases 1 and 2 are not as noticeable (Mann-Whitney U test:  $U = 16,00$ ;  $Z = 0,32$ ;  $p = 0,749$ ; see also figure 8.30).

The data from figures 8.29-8.31 are not easy to interpret, for the differences between the phases are limited, and the studied remains originate from a relatively small part of the settlement. At this point we should indicate the possibility that the above results could reflect a somewhat higher status of the inhabitants from building 1 during the Late Antiquity phase 2 compared to those who inhabited a different structure that stood on roughly the same area in Late Antiquity phase 1 (see Tonovcov grad. Settlement remains and interpretation, chapter 2.3).

The results from figure 8.31 show that the first three multidimensional scaling dimensions mostly summarise the degree to which samples resemble each other in the frequencies of more or less meat rich body parts, at the

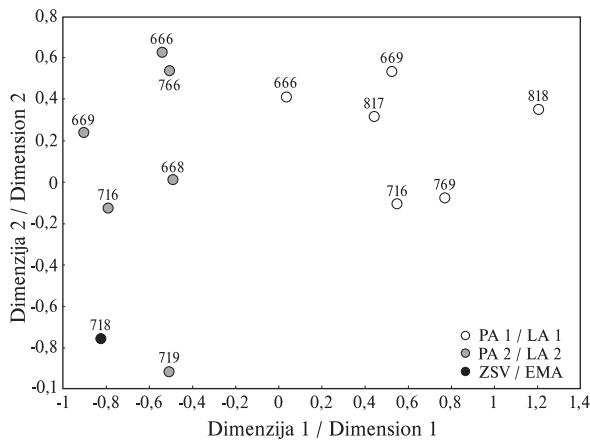

Sl. 8.31: Končna razporeditev matrike, pridobljene z večdimenzionalnim skaliranjem evklidskih razdalj med 13 vzorci (NISP > 90) sesalskih ostankov s Tonovcovega gradu: območje stavbe 1. Matrika različnosti je bila pridobljena na osnovi podatkov o številu vseh določenih sesalskih ostankov, številom ostankov domačega goveda, drobnice, prašiča, konja in vseh lovnih vrst ter številom kosti iz treh kvalitetnih kategorij trupa goveda in drobnice. Označbe vzorcev na diagramu ponazarjajo kvadrante izkopnega polja, iz katerih ostanki posameznih vzorcev izvirajo. Legenda: PA – poznoantična faza; ZSV – zgodnj srednjeveška faza.

Fig. 8.31: The final distribution of the matrix derived from multidimensional scaling of the Euclidean distances among 13 samples (NISP > 90) of mammalian remains at Tonovcov grad: area of building 1. The matrix contains data on the number of all taxonomically determined mammalian remains, number of remains of cattle, sheep/goats, pigs, horses and game as well as the number of remains of each of the three qualitative categories of the carcass of cattle and sheep/goats. The marks on the diagram depict the quadrants in the excavation field in which the remains of the individual samples were discovered. Legend: LA – Late Antiquity phase; EMA – Early Medieval phase.

trupa, saj ta kaže trend postopnega upadanja vrednosti vzdolž abscisne osi (= dimenzija 1) tako v primeru goveda kot tudi ovce/koze. Ostanki drobnice sicer izkazujejo podoben trend tudi vzdolž ordinatne osi (= dimenzija 2), vendar pa tukaj razlike med obema poznoantičnima fazama niso tako izrazite (Mann-Whitneyjev U-test:  $U = 16,00$ ;  $Z = 0,32$ ;  $p = 0,749$ ; glej tudi sliko 8.30).

Interpretacija podatkov s sliko 8.29–8.31 je težavna, saj so razlike med fazami majhne, obdelani ostanki pa izvirajo iz razmeroma skromnega dela celotne površine obravnavane nasebine. Na tem mestu bi tako le predvidno nakazala možnost, da bi lahko zgornji rezultati kazali na nekoliko višji status stanovanj stavbe 1 v obdobju druge poznoantične poselitvene faze Tonovcovega gradu nasproti tistim, ki so naseljevali neko drugo, na približno istem mestu stojčo stavbo (glej Tonovcov grad. Naselbinski ostanki in interpretacija, pogl. 2.3) v prvi poznoantični fazi.

Rezultati s slike 8.31 med drugim kažejo, da izbrane tri dimenzije večdimenzionalnega skaliranja v

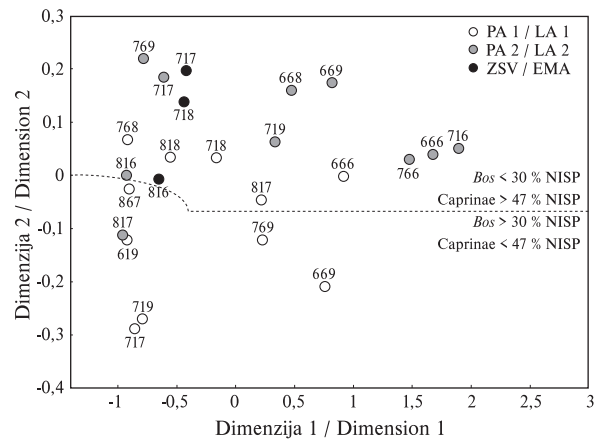

Sl. 8.32: Končna razporeditev matrike, pridobljene z večdimenzionalnim skaliranjem evklidskih razdalj med 24 vzorci (NISP > 40) sesalskih ostankov s Tonovcovega gradu: območje stavbe 1. Matrika različnosti je bila pridobljena na osnovi podatkov o številu ostankov domačega goveda, drobnice, prašiča, konja in vseh lovnih vrst ter številu vseh določenih sesalskih ostankov. Označbe vzorcev na diagramu ponazarjajo kvadrante izkopnega polja, iz katerih ostanki posameznih vzorcev izvirajo. Legenda: PA – poznoantična faza; ZSV – zgodnj srednjeveška faza.

Fig. 8.32: The final distribution of the matrix derived from multidimensional scaling of the Euclidean distances among 24 samples (NISP > 40) of mammalian remains at Tonovcov grad: area of building 1. The matrix contains data on the number of all taxonomically determined mammalian remains, number of remains of cattle, sheep/goats, pigs, horses and game. The marks on the diagram depict the quadrants in the excavation field in which the remains of the individual samples were discovered. Legend: LA – Late Antiquity phase; EMA – Early Medieval phase.

same time accounting for only a small part (dimension 3?) of the variance connected to the abundance of finds of an individual taxon or the total number of all mammalian finds. For this purpose we rearranged the input matrix to include only data on the abundance of cattle, sheep, goat, pig, horse, game as well as all mammalian remains within an individual assemblage (Fig. 8.32).<sup>71</sup> The multidimensional scaling was rerun (stress = 0.002) and three dimensions were created. Of these, statistically significant inter-phase differences were observed only in the case of the dimension 2 (Kruskal-Wallis test:  $H [2, N = 24] = 7.09$ ;  $p = 0.030$ ). The analysis has shown a decrease in the relative frequency of cattle remains along the ordinate axis (= dimension 2), while the contributions of caprines and pigs show an inversely proportional trend. At this the assemblages from the Late Antiquity phase 2 are grouped in the upper half of figure 8.32, and those from the Late Antiquity phase 1 in the lower half. Such a

<sup>71</sup> The analysis included samples with at least 40 taxonomically identifiable mammalian remains (i.e. NISP  $\geq$  40).

tem primeru povzemajo predvsem varianco, povezano z deležem zastopanosti ostankov posameznih kvalitativnih kategorij plena, le v manjši meri (dimenzija 3?) pa tudi tisto, ki je povezana s številom vseh sesalskih najdb oz. najdb posameznega taksona. V ta namen sva večdimenzionalno skaliranje aplicirala tudi na matriko različnosti, sestavljeno na podlagi podatkov o abundanci ostankov goveda, drobnice, prašiča, konja, vseh lovnih vrst ter vseh sesalcev znotraj posameznega vzorca (sl. 8.32).<sup>69</sup> Tudi tokrat sva specificirala tri dimenzije (stres = 0,002), pri čemer sva statistično značilne medfazne razlike ugotovila le v primeru vrednosti dimenzije 2 (test Kruskal-Wallis: H [2, N = 24] = 7,09; p = 0,030). Analiza podatkov je pokazala padanje relativne frekvence pojavljanja ostankov goveda vzdolž ordinatne osi (= dimenzija 2), medtem ko kaže ta deleža drobnice in prašiča obratno sorazmeren trend. Pri tem se vzorci iz druge poznoantične poselitvene faze grupirajo v zgornji polovici slike 8.32, tisti iz prve pa v spodnji. Takšen vzorec porazdelitve je skladen s podatki o zastopanosti domačega goveda, drobnice in prašiča v gradivu vsake od treh poselitvenih faz v celotnem vzorcu favnističnih najdb s Tonovcovega gradu, ki prav tako kaže na upad deleža goveda na račun drobnice na prehodu iz prve v drugo poznoantično fazo (tab. 8.4–8.5). Je pa v zvezi s tem pomembno opozoriti na bistveno bolj izraženo heterogenost v deležih zastopanosti posameznih taksonov med vzorci z najdbami iz prve poselitvene faze (sl. 8.32). Medtem ko leži kar devet od skupno desetih vzorcev z gradivom iz druge poznoantične faze na isti strani "sredinske črte",<sup>70</sup> je ta namreč enajst vzorcev z ostanki iz prve poznoantične faze praktično razdelila na dve polovici: pet jih leži nad omenjeno ločnico, šest pa pod njo. Pri poskusu interpretacije navedenih rezultatov se je treba zavedati, da so bili ti pridobljeni z analizo gradiva iz le dela izkopnega polja in tako morda niso reprezentativni za naselbino v celoti. Kljub temu pa večje heterogenosti obdelanega gradiva iz prve faze poznoantične poselitve Tonovcovega gradu v smislu deležev zastopanosti goveda in drobnice ne gre zanemariti. Lahko bi jo namreč razumeli tudi kot argument v prid tezi, da je bila razlika v pomenu obeh navedenih taksonov znotraj ekonomije prve in druge poznoantične poselitvene faze dejansko manjša od tiste, ki jo nakazuje zgolj število njunih ostankov v celotnem gradivu vsake od obeh obravnavanih faz (tab. 8.4–8.5).

<sup>69</sup> V analizo so bili vključeni le vzorci z najmanj 40 določljivimi sesalskimi ostanki.

<sup>70</sup> "Sredinska črta" je opredeljena kot ločnica med vzorci, pri katerih je bil ugotovljen nadpovprečno visok delež goveda ob nadpovprečno nizki vrednosti drobnice, ter vzorci, ki kažejo obratno sliko. Pri tem je bil povprečen delež zastopanosti navedenih taksonov izračunan na podlagi podatkov o njuni relativni frekvenci pojavljanja med sesalskimi ostanki iz obeh poznoantičnih faz.

pattern of distribution is in accordance to the data on the shares of cattle, caprines and pigs within the entire faunal assemblage collected at Tonovcov grad, which also shows a decline in the relative abundance of cattle due to an increase in the share of caprines at the transition between Late Antiquity phases 1 and 2 (Tabs. 8.4-8.5). Moreover, it is interesting to note the significantly greater heterogeneity in the contributions of individual taxa amongst the assemblages from the Late Antiquity phase 1 (Fig. 8.32). While nine out of the total of ten assemblages with Late Antiquity phase 2 material lie on the same side of the "central line",<sup>72</sup> the same line divided the eleven assemblages dated to the Late Antiquity phase 1 practically into two halves (i.e. five of them lie above the division and six below it). In the attempt of interpreting the results it had to be remembered that they were obtained through an analysis of the material from only a part of the excavated area and thus might not be representative for the settlement as a whole. However, the greater heterogeneity of the material from the Late Antiquity phase 1 should not be neglected as it could argue in favour of the thesis that inter-phase differences in the economic importance of cattle and caprines at Tonovcov grad were smaller than indicated by the number of the remains from the two Late Antiquity phases (Tabs. 8.4-8.5).

### 8.6.1 THE ROLE OF THE MAIN DOMESTICATES IN THE ECONOMY OF TONOVCOV GRAD

In Europe the importance of cattle, caprines and pigs in the economy of individual communities changed quite a bit in time and space between the mid 1<sup>st</sup> millennium BC to around 600 AD (King 1984; Forstenpointner *et al.* 2002, 58 f; MacKinnon 2004, 61 ff). Notable differences were observed between settlements from the same period and area, but which differed in their size and function (King 1984; Bartosiewicz 1990-1991; MacKinnon 2004, 61 ff). Data in table 8.1 indicate that the central role in the economy of the Late Antique/Early Medieval Tonovcov grad was played by cattle, even though caprines were represented by a larger number of finds. Taking into account the much greater body mass of cattle and its importance as a working animal, its role certainly surpassed what is suggested by the number of remains.

The data on the share of unfused bones indicate that the preferred culling age of cattle during each of the three settlement phases was of three years and older

<sup>72</sup> The "central line" is defined as the line dividing samples at which an above average share of cattle and a below average percentage of caprine remains have been found from those showing a reverse image. At this the average representation share of the stated taxa was calculated from the data on their abundances amongst the mammalian remains from Late Antiquity phases 1 and 2.

### 8.6.1 VLOGA OSREDNJIH VRST DOMESTIKATOV V EKONOMIJI TONOVCOVEGA GRADU

V evropskem prostoru je bil pomen domačega goveda, drobnice in prašiča v ekonomiji posameznih skupnosti iz obdobja od sredine 1. tisočletja pr. n. št. do okoli leta 600 n. št. v času in prostoru precej spremenljiv (King 1984; Forstenpointner *et al.* 2002, 58 s; MacKinnon 2004, 61 ss). Opazne razlike so bile ugotovljene tudi v primerjavi favnistične slike naselij iz istega obdobja in območja, ki pa so se razlikovale v velikosti in funkciji (King 1984; Bartosiewicz 1990–1991; MacKinnon 2004, 61 ss). Sodeč po podatkih iz *tabele 8.1* je osrednje mesto v ekonomiji poznoantičnega/zgodnj srednjeveškega Tonovcovega gradu zasedalo domače govedo, čeprav po številu najdb sicer prednjači drobnica. Spričo očitno večje mase goveda in pa njegovega pomena kot delovne živine je njegova vloga namreč zagotovo presejala tisto, na katero bi lahko sklepali zgolj iz ugotovljenega razmerja v številu ostankov.

Podatki o deležu zastopanosti kosti s še ne popolnoma zraščena epia in diafiza kažejo na to, da so na Tonovcovem gradu v vseh treh tukaj obravnavanih poselitvenih fazah preferenčno klali nad tri leta stara goveda (*tab. 8.8*). Vsaj kar zadeva prvo poznoantično fazo,<sup>71</sup> takšno sliko potrjujejo tudi podatki o stopnji obrabe žvekalne površine kočnikov (glej pogl. 8.3), pri čemer najdba spodnje čeljustnice domnevno deset do dvanajst tednov starega teleta morda kaže na lokalno rejo goveda (*cf.* MacKinnon 2004, Tab. 19). V večinskem zakolu odraslih živali bi se lahko odražala razmeroma intenzivna prireja mleka; pri govedoreji usmerjeni v proizvodnjo mesa, bi namreč med izkopanimi ostanki pričakovali večji delež kosti in zob telet. Po mnenju MacKinnona (2004, 205 s) naj v (pozni) antiki v okviru rimskega cesarstva kravje mleko ne bi igralo pomembnejše vloge, kar pa seveda ne izključuje lokalnih specifik. V politično in varnostno nestabilnem obdobju pozne antike bi namreč v ekonomsko avtarkičnih naselbinah tipa Tonovcov grad kravje mleko vsekakor predstavljalo dobrodošlo obogatitev dnevnega jedilnika. Po drugi strani pa lahko ugotovljeno starostno strukturo utemeljeno povezujemo tudi s pomenom goveda kot delovne živine. Spričo zahtevnosti govedoreje, o čemer poročajo tudi antični viri (*cf.* MacKinnon 2004, 89; a glej tudi MacKinnon 2004, 94), bi bil v nemirnem obdobju pozne antike množičen zakol mladih goved tako vse prej kot ekonomsko upravičen. Odvisnost takratnih skupnosti od produktov lastne poljedelske in živinorejske dejavnosti je namreč narekovala maksimiranje izkoriščanja teh za rejo relativno zahtevnih živali kot delovne živine na poljih oz. v transportu. Zaradi navedenega se je na

<sup>71</sup> Druga poznoantična ter zgodnj srednjeveška faza v tej primerjavi nista bili upoštevani, saj je razpoložljivo število vzorcev preskromno (tj.  $N = 1$ ).

at Tonovcov grad (*Tab. 8.8*). At least as regards the Late Antiquity phase <sup>73</sup> this picture is also confirmed by the tooth wear data (see chapter 8.3), with the find of a mandible of a ten to twelve weeks old calf possibly indicating that cattle was reared locally (*cf.* MacKinnon 2004, Tab. 19). In principle, the preferential culling of adults could be a reflection of a relatively intensive milk production. Namely, with a more meat-oriented cattle exploitation a higher contribution of calf remains would be expected. According to MacKinnon (2004, 205 f) cow's milk did not play an important role in the Roman empire in (Late) Antiquity, however this does of course not exclude local variation. Namely, in a politically unstable period as the Late Antiquity certainly was, cow's milk may have represented a welcome enrichment of the everyday menu to inhabitants of economically autarkic settlements such as Tonovcov grad. On the other hand the age profile indicated by the data in *table 8.8* can also be linked to the importance of cattle as working animals. Taking into account the demands of cattle husbandry, also emphasized by several Roman authors (*cf.* MacKinnon 2004, 89; but see also MacKinnon 2004, 94), the mass culling of young cattle would not be economically sound in the unstable Late Antique period. The dependence of communities on the products obtained from their own farming and stock rearing called for maximising the use of the relatively demanding cattle to rear as beasts of burden. Consequently, mainly the meat of animals unfit to work (i.e. old, injured specimens) found its way onto plates. Other Late Antique sites in the region show a similar age profile of the cattle at death (Riedel 1985, Tab. 2; Stork, von den Driesch 1987, Tab. 6; Riedel, Scarpa 1988, Tab. 1; Wilkens 1990, 308 ff; Riedel 1993b, Tab. 9; Turk 2000, 169; Bartosiewicz, Choyke 1985).

Further insights into the role of cattle in the economy of Tonovcov grad were obtained by analyzing the sex profile. Of the three metapodials and the 14 sufficiently preserved pelvis fragments those of cows prevail ( $N = 14$ ), while only the metatarsal from sample No. 2038 (sq. 668, 669; mqu: D3, D4) was assigned to a bull. In this sample ox was represented by a mere two finds, even though it – as a rule – represents an ideal choice for work in the fields. If the estimated ratio between the sexes is at least roughly representative and if it is not to be ascribed to the less likely orientation toward a more intensive milk production, the observed sex ratio could be interpreted as a reflection of the farmer's compromise between the need to ensure a sufficient amount of fodder for the cattle on one hand and field crops for himself and his family on the other. Feeding a single pair of oxen would demand between 10 and 12 ha of pasture, which represented a great challenge for the mostly small Late Antique farming communities. As stated already by Roman authors

<sup>73</sup> Due to the small number of specimens (i.e.  $N = 1$ ) the Late Antiquity phase 2 and the Early Medieval phase were not taken into account for this comparison.

krožnikih večinoma znašlo le meso za delo odsluženih (tj. starih, poškodovanih ipd.) primerkov. Skladni s tem so podatki o starostni strukturi goved ob zakolu/poginu tudi v okviru drugih poznoantičnih najdišč v regiji (Riedel 1985, Tab. 2; Stork, von den Driesch 1987, Tab. 6; Riedel, Scarpa 1988, Tab. 1; Wilkens 1990, 308 ss; Riedel 1993b, Tab. 9; Turk 2000, 169; Bartosiewicz, Choyke 1985).

V kontekstu ugotavljanja osrednjih produktov govedoreje je povedna tudi spolna struktura populacije omenjene vrste s Tonovcovega gradu. Med sicer le tremi metapodiji in 14 zadovoljivo ohranjenimi fragmenti medenice namreč močno prednjačijo ostanki krav (N = 14), medtem ko sva biku pripisala le stopalnico iz vzorca št. 2038 (kv. 668, 669; mkv: D3, D4). Vol je bil v navedenem vzorcu zastopan z zgolj dvema najdbama, čeprav je načeloma zagotovo predstavljal idealno izbiro za delo na polju. Če je ocenjeno razmerje med spoloma vsaj v grobem reprezentativno in v kolikor ga ne gre pripisati sicer manj verjetni želji po intenzivnejši prireji mleka, bi dobljeno sliko lahko interpretirali kot odraz kmetovega kompromisa med potrebo po zagotavljanju zadostnih količin krme za živino na eni strani ter poljščin zase in družino na drugi. Reja le enega para volov naj bi namreč zahtevala kar 10 do 12 ha veliko pašniško površino, kar je nedvomno pomenilo velik pritisk na po večini domnevno majhne poznoantične kmetijske skupnosti. Kot so navajali že antični pisci, je v takih primerih izhod v sili lahko predstavljalo zmanjšanje števila volov v čredah na račun krav (MacKinnon 2004, 95 s). Te so namreč z vidika reje bistveno manj zahtevne, še vedno pa lahko služijo kot delovna živina na poljih.

Ugotavljanje vloge mesa ter posameznih sekundarnih produktov reje je bilo v primeru drobnice še nekoliko bolj zapleteno, saj je bilo do vrste mogoče določiti zgolj 15,5 odstotka najdb. Tradicionalen pristop k problematiki je temeljil na ocenah starostne strukture drobnice, a brez upoštevanja razlik v obstojnosti med ostanki juvenilnih in že odraslih živali. Iz takšnih ocen izhajajoče ugotovitve so bile zato z vidika ovčereje/kozjereje pogosto neutemeljene (Cribb 1984), zato je Munson (2000) ponudil alternativen pristop. Ugotovljene frekvence pojavljanja zob ovac /koz posameznih starostnih razredov v arheološkem vzorcu naj bi se tako najprej utežile glede na njihovo sposobnost kljubovanja poodložitvenim destruktivnim dejavnikom, nato pa tako korigirane frekvence primerjale z bogato zbirko arheoloških in etnoarheoloških mortalitetnih statistik za omenjeni dve vrsti (cf. Munson 2000, 401 ss).

Korigirana starostna struktura za drobnico iz prve faze<sup>72</sup> poznoantične poselitve Tonovcovega gradu izkazuje polovični delež do enega leta starih ovac/koz. Ob tem relativna frekvenca pojavljanja zob živali, ki so bile

<sup>72</sup> Zgodnjerednjevska faza v to analizo ni bila vključena, saj je razpoložljivo število zob preskromno. Podatki za drugo poznoantično fazo so podani v nadaljevanju.

a solution to this was the reduction of the numbers of oxen relative to cows (MacKinnon 2004, 95 f), for they are much less demanding as regards maintenance and yet they can be used as working animals in the field.

Appraising the role of meat vs. individual secondary products was slightly more complicated in the case of caprines, for only 15.5 percent of the finds could be identified to the level of species. The traditional approach to the issue is based on the estimates of the age profile of sheep/goat, but without taking into account the differences in the preservation of juvenile and adult animal remains on and in the sediment. Conclusions drawn from such estimations were thus often unfounded from the aspect of sheep or goat breeding (Cribb 1984), thus Munson (2000) offered an alternative approach: the frequencies of caprine teeth from individual age classes within an archaeological assemblage should be corrected in order to (at least partially) take into consideration differential taphonomic loss. Such corrected frequencies are then to be compared to the rich collection of archaeological and ethno-archaeological mortality statistics for these two species (cf. Munson 2000, 401 ff).

The corrected mortality profile for caprines from the Late Antiquity phase 1<sup>74</sup> of Tonovcov grad indicates a 50 % share of teeth indicating animals up to one year of age. At this the relative frequency of sheep/goats that were culled or have died in their second year of life, does not reach even one tenth of all the ageable specimens (Tab. 8.12). The modern-ethnographic-historic mortality profiles for caprines allows various interpretations for such an age structure (subgroup 2b *sensu* Munson 2000, 401 f). Thus it is for instance possible that the farmers have opted to enlarge their herds by retaining a higher proportion of female young. A slightly more likely option seems to be the possibility that the data from table 8.12 reflects a relatively low fertility rate (which is often associated with extreme wool emphasis). Finally, the described mortality profile could, in principle, also reflect the sale ("export") of a large number of lambs and kids for culling. Nevertheless, in view of the importance of the Late Antique settlement of Tonovcov grad, which was *de facto* the local (religious) centre, such a rearing policy is not likely. On the contrary: if a military unit was stationed at this location during Late Antiquity phase 1 – as indicated by certain archaeological finds (see chapter 2.1) – army meat provisioning may have even been imported (cf. MacKinnon 2004, 226), as is known to have occurred with olive oil and possibly wine (see chapter 4.1). At this it should be mentioned, that the possible imports of caprines from the countryside, where the farmers would keep most lambs/kids for themselves,<sup>75</sup>

<sup>74</sup> Due to the insufficient number of teeth, the Early Medieval phase was not included into this analysis. Data for Late Antiquity phase 2 are provided below.

<sup>75</sup> Such action could be lead by the desire to increase their herds or a low fertility rate (which could be a consequence of intensive wool production).



zaklane oz. so poginile v svojem drugem letu življenja, ne dosega niti desetine vseh analiziranih primerkov (tab. 8.12). Izhajajoč iz modernih etnografsko-historičnih mortalitetnih profilov za drobnico dopušča takšna starostna struktura (podskupina 2b *sensu* Munson 2000, 401 s) različne interpretacije. Tako je npr. mogoče, da so se kmetje odločili za povečanje svojih čred in zato pri življenju ohranjali razmeroma visok delež samic. Še nekoliko verjetnejša se zdi možnost, da podatki iz *tabele 8.12* govorijo o relativno nizki stopnji rodnosti (kar pogosto povezujemo z izrazitim naporom, usmerjenim v pridobivanje volne). Ne nazadnje pa bi navedeno starostno strukturo lahko razložili tudi kot dokaz prodaje ("izvoza") velikega števila jagenj in kozličev za zakol, kar pa je v primeru lokalnega središča, kot je bil Tonovcov grad, vendarle manj verjetno. Celó nasprotno. Če se je med prvo fazo poznoantične poselitve obravnavanega najdišča tu res zadrževala vojaška posadka, na kar kažejo nekatere arheološke najdbe (glej pogl. 2.1), potem so morda takrat na Tonovcov grad meso (za vojsko) celo "uvažali" (cf. MacKinnon 2004, 226); nenazadnje je tak uvoz izpričan za oljčno olje in morda vino (glej pogl. 4.1). Pri tem velja omeniti, da bi morebiten uvoz drobnice s podeželja, kjer bi kmetje večino jagenj/kozličev zadržali zase,<sup>73</sup> prav tako rezultiral v prevladi do enega leta starih živali (pričakovan razpon: 40–60 %) in zanemarljivem deležu (tj. 7–10 %) dvoletnih (podskupina 2b *sensu* Munsel 2000, 403).

Sodeč po podatkih iz *tabele 8.12* je reja drobnice na območju Tonovcovega gradu v 6. stoletju (tj. drugi poznoantični fazi) doživela določene modifikacije. Na podlagi korigirane starostne strukture se namreč zdi, da je bila reja ovac/koz v tem obdobju usmerjena predvsem v prirejo mesa oz. mesa in mleka, medtem ko naj bi imela volna nekoliko manjši pomen (podskupina 1a *sensu* Munson 2000, 401). Podobno visoke (tj. > 70 %) deleže zastopanosti do enega leta starih živali med zaklanimi/poginulimi ovcami/kozami, ob sočasni zanemarljivi zastopanosti dvoletnih (< 15 %), izkazujejo agrarne skupnosti, ki drobnico vzrejajo (skoraj) izključno za lastne potrebe in ki vzdržujejo konstantno velikost čred. Pri tem naj bi razlikovanje med rejo, ki je usmerjena predvsem v izkoriščanje mesa, in tisto, ki daje prednost prireji mleka, izkazovalo razmerje v številu do šest mesecev starih ovac/koz nasproti številu med šest in dvanajst mesecev starih živali (Munson 2000, 401). Za poznoantični Tonovcov grad bi tako lahko sklepali, da je bilo pri kozjereji nekoliko bolj v ospredju pridobivanje mleka (prevladujejo mlečni četrti predmeljaki do šest mesecev starih živali; tab. 8.22), pri ovčereji pa mesa (zobje do šest mesecev starih primerkov manjkajo; tab. 8.23). Pičlo število podatkov sicer specifično težo navedenih ugotovitev nedvomno precej

<sup>73</sup> K takšnemu postopanju bi jih lahko vodila želja po povečanju lastnih čred ali nizka stopnja rodnosti (ki pa bi bila, kot že navedeno, lahko posledica intenzivnega izkoriščanja volne).

would also result in the dominance of up to one year old animals (expected range: 40–60 %) and a negligible (i.e. 7–10 %) share of those in the second year of life (subgroup 2b *sensu* Munsel 2000, 403).

Data from *table 8.12* shows that in the 6<sup>th</sup> century (i.e. Late Antiquity phase 2) sheep and goat exploitation at Tonovcov grad experienced a certain modification. On the basis of the corrected mortality profile it appears that caprine husbandry in this period was oriented primarily toward the production of meat or meat and milk, while wool supposedly had slightly less importance (subgroup 1a *sensu* Munson 2000, 401). Similarly high representation (i.e. > 70 %) of remains from up to one year old caprines, and a negligible proportion of those in their second year of life (< 15 %) are shown in agricultural communities that keep sheep/goat (almost) exclusively for their own needs and that preserve a constant herd size. At this profiles with more than two-thirds of young in the 2–6 months old class might be indicative of milk emphasis, whereas those with more than two-thirds of the young in the 6–12 months old class might reflect meat emphasis (Munson 2000, 401). For Late Antique Tonovcov grad we could conclude that in goat exploitation milk production was slightly more important than meat (note the prevalence of fourth deciduous premolars of up to six months old animals; *Tab. 8.22*), while in sheep it has been the opposite (note the lack of teeth of up to six months old animals; *Tab. 8.23*). The poor data undoubtedly greatly reduce the weight of these conclusions, but two points should be mentioned. According to Antique sources goat's milk was the most popular milk in Italy during the Roman period (cf. MacKinnon 2004, 205). The second derives from the study of the ratios between the size of the animal stocks and the culling frequency in 27 African and Southeast Asian countries in which animal husbandry is sufficiently well developed to suffice for the needs of the local population (Bartosiewicz 1985, 177 ff). These results have shown that (independent of the actual natural and cultural factors) sheep and pig may complement each other in meat production. The relatively modest number of pig remains compared to the numerous finds of young caprine individuals (supposedly mainly sheep) might indicate that the inhabitants of the Late Antique Tonovcov grad substituted for the lack in the pig production with a greater emphasis on sheep meat.

Pig was not as important as cattle and caprines at Tonovcov grad (*Tabs. 8.1, 8.4–8.5*). This seems to contradict the assumption that pork was more appreciated than beef/veal, sheep and goat meat in Roman period Italy (MacKinnon 2004, 217). However, sites with higher contributions of pig remains can be found predominantly in the south and central part of the Apennine Peninsula, while in the north (especially in towns) cattle was always in the forefront (MacKinnon 2004, 68 ff). Antique sources include *Galia cisalpina* amongst the regions with more intensive pig breeding

Tab. 8.22: Starost (v mesecih) koz s Tonovcovega gradu, kot izhaja iz obrabe žvekalne površine četrtilh mlečnih predmeljakov (cf. Payne 1985, 142). Legenda: PA – poznoantična faza; ZSV – zgodnj srednjeveška faza.

Tab. 8.22: Age (in months) at death of goats from Tonovcov grad, based on data on the wear of forth deciduous premolars (cf. Payne 1985, 142). Legend: LA – Late Antiquity phase; EMA – Early Medieval phase.

Stopnja obrabe Wear stage	Starost Age	PA 1 LA 1	PA 2 LA 2	ZSV EMA
1	0–2	1	2	-
2–3	2–6	1	-	-
4–5	2–12	-	-	1
6	6–12	-	-	-
7	6–24	-	1	-
8–10	12–24	-	-	-

zmanjšuje, vseeno pa velja omeniti dve, z njim povezani zanimivosti. Prva se nanaša na dejstvo, da je bilo v rimskodobni Italiji najbolj priljubljeno mleko prav kozje, o čemer poročajo tudi antični viri (cf. MacKinnon 2004, 205). Druga pa izhaja iz študije razmerij med velikostjo živali in klavno frekvenco v 27 afriških in jugovzhodnoazijskih deželah z dovolj razvito živinorejo, da ta zadošča potrebam tam živečega prebivalstva (Bartosiewicz 1985, 177 ss). Njeni rezultati so namreč pokazali, da se lahko v smislu prireje mesa (neodvisno od dejanskih naravnih in kulturnih danosti) prašič uspešno dopolnjuje prav z ovco. Razmeroma skromno število prašičjih ostankov nasproti številnim najdbam ostankov mladih živali drobnice (domnevno predvsem ovce) tako morda nakazuje, da so prebivalci poznoantičnega Tonovcovega gradu “primanjkljaj” v prireji prašičjega mesa dejansko nadomestili z večjim zakolom mladih ovac.

Domači prašič je bil v okviru poznoantičnega (na podlagi razpoložljivih najdb pa domnevno tudi zgodnj srednjeveškega) Tonovcovega gradu manj pomemben od goveda in drobnice (tab. 8.1; 8.4–8.5). Ugotovitev je v navideznem nasprotju z dejstvom, da je bila svinjina v rimskodobni Italiji sicer bolj cenjena od govejega/telečjega, ovčjega in kozjega mesa (MacKinnon 2004, 217). Vendar pa najdišča z izstopajočimi deleži zastopanosti prašiča najdemo predvsem na južnem in osrednjem delu Apeninskega polotoka, medtem ko je bilo na severu (sploh v mestih) ves čas v ospredju govedo (MacKinnon 2004, 68 ss). Antični viri sicer med regije z intenzivno prašičerejo in predelavo svinjine prištevajo tudi Predalpsko Galijo (*Galia cisalpina*), predvsem območje okrog današnjega Milana (MacKinnon 2004, 152 s). Resnici na ljubo predstavljajo prašičji ostanki v okviru najdišča Monte Barro skoraj 60 odstotkov vseh določenih favnističnih najdb (Baker 1991, 156). Nižja, a še vedno razmeroma visoka relativna številčnost

Tab. 8.23: Starost (v mesecih) ovc s Tonovcovega gradu, kot izhaja iz obrabe žvekalne površine četrtilh mlečnih predmeljakov (cf. Payne 1985, 142). Legenda: PA – poznoantična faza; ZSV – zgodnj srednjeveška faza.

Tab. 8.23: Age (in months) at death of sheep from Tonovcov grad, based on data on the wear of forth deciduous premolars (cf. Payne 1985, 142). Legend: LA – Late Antiquity phase; EMA – Early Medieval phase.

Stopnja obrabe Wear stage	Starost Age	PA 1 LA 1	PA 2 LA 2	ZSV EMA
1	0–2	-	-	-
2–3	2–6	-	-	-
4–5	2–12	2	11	-
6	6–12	-	5	-
7	6–24	1	3	2
8–10	12–24	2	1	-

and pork production, especially the area surrounding today's Milan (MacKinnon 2004, 152 f). At Monte Barro pig remains indeed represent almost 60 percent of all taxonomically identified faunal finds (Baker 1991, 156), with little less than 40 percent observed in the area of Altino near Venice as well (Riedel 1985, 134). Nevertheless, at most sites in *Galia cisalpina* pig did not exceed a one third contribution (Riedel 1983, 4; Stork, von den Driesch 1987, Tab 1; Boschin, Weissteiner 2007, Tab. 3), which also holds true for Tonovcov grad (Tab. 8.1).

Archaeological data undoubtedly indicate that the popularity of domestic pig varied between Roman communities in various parts of the empire (cf. King 1984; Forstenpointner *et al.* 2002, 58 f; MacKinnon 2004, 61 ff). It seems that in the modest contribution of this species to the material from Tonovcov grad factors beyond human preference are also reflected. To our knowledge the relatively small number of pig remains is also shown in all other archeozoologically analysed sites in the Soča valley, regardless of the period: Iron Age and Roman period assemblages from Most na Soči (Bartosiewicz 1985, Tab. 1; 1986, Tab. 1), Roman period remains from Gradič near Kobarid (NISP = 7479; own unpublished data), material from the Iron age site of Grgar-Grašiče (NISP = 130; own unpublished data) as well as the small assemblage from the prehistoric burial site in Tolmin (Bartosiewicz 2002; Di Martino 2002).

It is known that keeping pigs in covered shelters is a relatively new trend that dates back to the beginning of the 19<sup>th</sup> century (Kryštufek 1991, 238). Prior to this pigs wandered around foraging freely (cf. Baker, Clark 1993, 52), thus their numbers were significantly influenced by the forest grazing at their disposal (Krže 1982, 24). The map depicting the potential natural vegetation in Slovenia (Zupančič, Wraber 1989, 119) shows that the forests in the area of the Upper and Central Soča Valley

ostankov omenjene vrste (tj. 38 %) je bila ugotovljena tudi na območju Altina pri Benetkah (Riedel 1985, 134). V okviru večine najdišč iz Predalpske Galije pa prašič vendarle ne presega tretjinski delež zastopanosti (Riedel 1983, 4; Stork, von den Driesch 1987, Tab 1; Boschin, Weissteiner 2007, Tab. 3), kar velja tudi za Tonovcov grad (tab. 8.1).

Arheološki podatki nedvoumno kažejo, da je bila priljubljenost domačega prašiča med rimskodobnimi skupnostmi iz različnih delov cesarstva različna (cf. King 1984; Forstenpointner *et al.* 2002, 58 s; MacKinnon 2004, 61 ss). Navkljub temu se zdi, da se v skromnem deležu zastopanosti omenjene vrste med gradivom s Tonovcovega gradu najverjetneje kažejo tudi nekateri drugi, od človekovih siceršnjih preferenc neodvisni dejavniki. Po najini najboljši vednosti namreč relativno pičlo število prašičjih ostankov izkazuje tudi sesalska makrofavna z vseh ostalih arheozoološko obdelanih najdišč v Posočju, in to ne glede na obdobje: železnodobni in rimskodobni vzorec z Mosta na Soči (Bartosiewicz 1985, Tab. 1; 1986, Tab. 1), rimskodobni ostanki z Gradiča pri Kobaridu (NISP = 7479; lastni neobjavljeni podatki), gradivo iz železnodobnega najdišča Grgar - Grašišče (NISP = 130; lastni neobjavljeni podatki) ter tudi sicer skromen vzorec iz prazgodovinskega grobišča v Tolminu (Bartosiewicz 2002; Di Martino 2002).

Znano je, da je hlevska reja prašičev mlada in sega v začetek 19. stoletja (Kryštufek 1991, 238). V obdobjih pred tem so se tako prašiči večinoma prosto pasli (cf. Baker, Clark 1993, 52), zato je na njihovo številčnost močno vplivala količina gozdne paše (Krže 1982, 24). Iz karte potencialne naravne vegetacije Slovenije (Zupančič, Wraber 1989, 119) izhaja, da predstavljajo na območju Zgornjega in Srednjega Posočja klimaksni gozd predvsem združbe *Anemono-Fagetum s. lat.*, *Ostryo-Fagetum s. lat.* ter *Seslerio-Fagetum*. Njihova floristična sestava nedvomno ustreza prehranskim navadam prašičev (cf. Krže 1982, 47 ss), saj poleg plodnosne bukve vključujejo tudi druge zanje prehransko pomembne rastline (cf. Dakskobler 1996; 2004). Razmeroma nizek delež prašiča v favnističnem gradivu s Tonovcovega gradu torej domnevno ne gre povezovati z neustrezno vegetacijsko sliko. Prav tako tudi ne s prizadetostjo naravne gozdne vegetacije zaradi oblikovanja pašnikov in polj, do česar je okrog dalj časa trajajočih naselbin sicer prihajalo vse od mlajše kamene dobe dalje (cf. Culiberg 1995, 205; Andrič, Willis 2003, 817). Obsežno trebljenje gozdov je bilo tako npr. dokazano tudi za okolico železnodobnih naselij v rečnih dolinah vzhodne Slovenije (cf. Culiberg, Šercelj 1995, 199 s), pa je tam delež domačega prašiča v okviru favnističnih vzorcev kljub temu vsaj primerljiv z deležem drobnice (Bartosiewicz 1996, 33). Iz navedenega tako izhaja, da je treba skromen delež prašiča med sesalskimi ostanki z najdišč v Posočju (vključno s Tonovcovim gradom) najverjetneje pripisati reliefu območja. Zaradi tipa habitata so se morali sicer razmeroma neizbirčni prašiči (cf. Kryštufek 1991,

consists of mainly *Anemono-Fagetum s. lat.*, *Ostryo-Fagetum s. lat.* and *Seslerio-Fagetum*. Such a vegetation undoubtedly suits the pigs' eating habits (cf. Krže 1982, 47 ff), for apart from beech they also include other important nutritional plants (cf. Dakskobler 1996; 2004). The relatively low incidence of pig bones in the faunal material from Tonovcov grad is therefore not to be linked with the inadequate type of vegetation. It cannot be explained by deforestation either, eventhough it is well known that man created pastures and fields around permanent settlements from the Middle Stone Age onwards (cf. Culiberg 1995, 205; Andrič, Willis 2003, 817). After all, evidence of vast deforestation was also found in the surroundings of the Iron Age settlements in the river valleys of Eastern Slovenia (cf. Culiberg, Šercelj 1995, 199 f), however the contribution of pig remains to the faunal assemblages from that region is still at least comparable to the percentage of caprine bones (Bartosiewicz 1996, 33). It thus follows that the low relative abundance of pigs within the sites in the Soča valley area (including Tonovcov grad) should most likely be attributed to the topography of the area. On local steep slopes the otherwise undemanding pigs (cf. Kryštufek 1991, 237; MacKinnon 2004, 153) had to give way to the better adapted sheep and goats, while the dry terrain in the relatively narrow Soča Valley would also have been an unfavourable pig habitat.

At Tonovcov grad pigs were the only domesticated animals that were reared exclusively for meat and fat. This can clearly be seen from the mortality profile (Tabs. 8.10-8.11), which indicates a preferential culling of young and subadult animals. At this the individual finds of specimens that were over three years old are most probably to be understood as a reflection of their use for reproduction purposes (cf. MacKinnon 2004, 152).

### 8.6.2 TONOVCOV GRAD AS A MILITARY POST

Certain archaeological data indicate that during the Late Antiquity phase 1 the settlement of Tonovcov grad might have housed a military unit (see chapter 2.1). Meat played an universally important part in the military menu (King 1984, 188; Riedel 1993a; MacKinnon 2004, 210); however, both the consumption pattern and the preference for meat types varied greatly in space and time (King 1984, 197 ff; Bartosiewicz 1990-1991). Interregional deviations are most noticeable in the role of pork *versus* mutton/goat meat, at which the former meat type were preferred in Germany and the latter in Britain. Otherwise, in both areas – as well as in Northern France, Benelux, Switzerland, Austria (King 1984, 197 ff), Bulgaria (Johnstone 2007) and Hungary (Bartosiewicz 1990-1991, Tab. 2) – cattle was by far best represented in military camps.

237; MacKinnon 2004, 153) na tamkajšnjih strmih pobočjih povečini umakniti drobnici, neugodne prehranske razmere pa so bile zanje tudi na suhih tleh razmeroma ozke Soške doline.

Sicer pa je bil na Tonovcovem gradu prašič edina domača žival, katere reja je bila usmerjena izključno v pridobivanje mesa in maščob. To dokazuje tudi starostna struktura (*tab. 8.10–8.11*), ki izkazuje preferenčen zakol mladih in subadultnih živali. Pri tem gre posamezne najdbe več kot tri leta starih primerkov najverjetneje razumeti kot dokaz njihove uporabe za reprodukcijo (*cf. MacKinnon 2004, 152*).

### 8.6.2 TONOVCOV GRAD KOT VOJAŠKA POSTOJANKA

Nekateri arheološki podatki kažejo, da je bila med prvo poznoantično poselitveno fazo Tonovcovega gradu v naselbini morda nastanjena vojaška posadka (glej pogl. 2.1). Znano je, da je bilo meso pomembna komponenta vojaškega jedilnika (King 1984, 188; Riedel 1993a; MacKinnon 2004, 210), pri čemer izbor vrste mesa izkazuje precejšnjo variabilnost v prostoru in času (King 1984, 197 ss; Bartosiewicz 1990–1991). Odstopanja so opazna predvsem, kar zadeva vlogo drobnice in prašiča, pri čemer prva večje deleže zastopanosti izkazuje na območju Britanije, prašič pa v Nemčiji. Na obeh območjih, tako kot tudi v severni Franciji, Beneluksu, Švici, Avstriji (King 1984, 197 ss), Bolgariji (Johnstone 2007) in na Madžarskem (Bartosiewicz 1990–1991, *Tab. 2*) pa po številu ostankov v vojaških taborih praviloma prednjači govedo.

O prehrani rimske vojske na območju jugovzhodnih Alp je težko govoriti, saj močno primanjkuje verodostojnih podatkov (*cf. MacKinnon 2004, 226*). Po najini najboljši vednosti lahko tako na vlogo posameznih vrst domestikatov v vojaški prehrani na širšem območju Tonovcovega gradu sodiva le na primeru Ajdovščine/*Castra*.<sup>74</sup> Ta je bila namreč v četrtem stoletju pomembna vojaška postojanka, ki je varovala enega osrednjih dostopov v Italijo z vzhoda. Čeprav je razpoložljivi vzorec skromen (NISP = 414), je vseeno poveden: tudi tu so namreč prevladujoči ostanki domačega goveda (*tab. 8.24*). Ugotovitev je po svoje pričakovana in skladna s trendi, ki so bili ugotovljeni drugje po Evropi (*cf. King 1984, 189 ss, 198*). Ker je bilo govedo v jugovzhodnoalpskem prostoru osrednja domača žival že pred prihodom Rimljanov (*sl. 8.33*), romanizacija večjih sprememb na jedilniku staroselcev ni povzročila, zato tudi ni prihajalo

<sup>74</sup> Morda je bila vojaška enota v pozni antiki locirana tudi v naselbini Sv. Pavel nad Vrtovinom (8 km zahodno od Ajdovščine), kjer med nekaj ducati sesalskih ostankov po številu najdb prednjači govedo pred prašičem (Svoljšak 1985, 226 s), relativno pogosti pa so tudi ostanki lovnih vrst (*cf. Bartosiewicz 1990–1991, 108*).

Due to the lack of reliable data it is not easy to define the diet of the Roman army in the Southeastern Alps (*cf. MacKinnon 2004, 226*). To our best knowledge for the broader area of Tonovcov grad such data are known only in the case of Ajdovščina/*Castra*.<sup>76</sup> In the 4<sup>th</sup> century this was an important military post that protected one of the main gates into Italy from the East. Even though the assemblage is small (NISP = 414) it is still meaningful as cattle remains also prevail (*Tab. 8.24*). This observation was to be expected and is in accordance with trends shown elsewhere in Europe (*cf. King 1984, 189 ff, 198*). As cattle was the main domesticate in the southeastern Alpine area already prior to the arrival of the Romans (*Fig. 8.33*), the Romanisation itself apparently did not bring any greater changes to the diet of the indigenous people, thus there was no need to adjust the military menus to the local customs or vice versa (*cf. King 1984, 198*).

With the above in mind one could argue, that the relatively higher share of cattle in the material from the Late Antiquity phase 1 of Tonovcov grad may reflect the import of meat into the settlement in order to supply the soldiers. Even though it is known that the military often reared their own cattle (MacKinnon 2004, 210), the Roman state established an organised military food provisioning system, including the delivery of meat to its army (MacKinnon 2004, 226). The unstable conditions in Late Antiquity disturbed the efficient operation of this system that forced the military to search alternative sources of meat and fat (hunting, fishing; Bartosiewicz 1990–1991). However, in the case of Tonovcov grad no greater inter-phase differences were noticed in the species richness (*Tab. 8.4–8.5; Fig. 8.13*), as finds of game and fish remained negligible throughout. We should also mention a practically identical contribution of cattle cranial remains in relation to postcranial bone found in the material from Late Antiquity phases 1 and 2 (i.e. 27.2 % and 26.7 %), which also opposes the thesis on the import of greater numbers of cattle for the needs of the army.<sup>77</sup> As indicated by the analysis of cattle finds from urban centres from Roman Period Italy, the heads were usually removed at the place of slaughter (as a part of the primary butchering of the animal) and thus did not reach the market together with the rest of the carcass. The consequences of such actions can of course also be seen in the faunal mate-

<sup>76</sup> It is possible that in Late Antiquity a military unit was stationed in the vicinity of the settlement of Sv. Pavel above Vrtovin (8 km west of Ajdovščina), where – among the several dozen mammalian remains – cattle was the most commonly represented species (Svoljšak 1985, 226 f). Notably (*cf. Bartosiewicz 1990–1991, 108*) pigs and game were also relatively common.

<sup>77</sup> As the finds mainly originate from the area of structure 1, these results should be understood as a reflection of the preferences of the occupants of this structure (area) and not necessarily the site as a whole.

do prilagajanja jedilnika vojske lokalnim običajem in obratno (cf. King 1984, 198).

V relativno višjem deležu zastopanosti domačega goveda v gradivu iz prve poznoantične poselitve Tonovcovega gradu bi se lahko, glede na zgoraj navedeno, odražal prav uvoz mesa v naselbino za oskrbo tam nameščenih vojakov. Čeprav je znano, da se je vojska pogosto ukvarjala z rejo lastnih čred živine (MacKinnon 2004, 210), pa je rimska država v obdobju cesarstva vzpostavila tudi organiziran sistem dobavljanja hrane (vključno z mesom) svojim vojakom (MacKinnon 2004, 226). Nestabilne razmere v pozni antiki so učinkovito delovanje omenjenega sistema ovirale, kar je vojsko sililo v iskanje alternativnih virov mesa in maščob (lov, ribolov; Bartosiewicz 1990–1991). Vendar pa v primeru Tonovcovega gradu omembe vrednih medfaznih razlik v vrstnem bogastvu vzorcev ni opaziti (tab. 8.4–8.5; sl. 8.13), število najdb lovnih vrst pa ostaja ves čas zanemarljivo. Omeniti velja tudi praktično identičen delež zastopanosti kranialnih ostankov goveda nasproti elementom postkranialnega skeleta v okviru gradiva iz obeh poznoantičnih faz (tj. 27,2 % in 26,7 %), kar prav tako nasprotuje tezi o uvozu večjih količin govedine za potrebe vojske.<sup>75</sup> Kot so pokazale analize govejih najdb iz urbanih središč rimskodobne Italije, so namreč glave praviloma odstranili na kraju zakola v okviru osnovnega raztelesenja živali in tako večinoma niso prišle na trg skupaj s trupom. Posledice takšnega postopanja se seveda kažejo tudi v favnističnem gradivu, predvsem v slabši zastopanosti zob, čeljustnic in lobanj (MacKinnon 2004, 219). Prav takšno sliko kažejo goveji ostanki iz vojaške postojanke Dichin/*Nicopolis* v Bolgariji (Johnstone 2007, 292), medtem ko v primeru Tonovcovega gradu, kot že navedeno, ni bilo tako.

K zgornjemu velja dodati še nekaj besed v zvezi s postopkom raztelesenja goved. Detajlna študija frekvenc in pa mest pojavljanja usekov in urezov na posameznih skeletnih elementih sicer presega namen pričujočega prispevka. Se pa zdi na tem mestu vendarle smiselno omeniti, da so epifize dolgih kosti okončin goveda v vzorcu s Tonovcovega gradu večinoma nepoškodovane. Ugotovitev je pomembna, saj kažejo goveji ostanki, izkopani v vojaških taborih, praviloma precej drugačno sliko. Postopek raztelesenja goved je bil tam namreč bistveno bolj "avtomatiziran" in je težil predvsem k produciranju enakomerno velikih porcij (cf. Riedel 1993b, 226 ss; Stokes 2000, 147). Spričo manjše pozornosti, namenjene dejanski mikrolokaciji udarca s sekuro oz. zarezu z nožem na posameznih kosteh, čemur je do neke mere zagotovo botrovala tudi (pre)zaposlenost vojaških mesarjev, goveji ostanki iz vojaških taborov izkazujejo tudi večji delež dolgih kosti s poškodovano epifizo (cf. Maltby 1989, 90; Riedel 1993b, 227). Maloštevilnost tako poškodovanih

<sup>75</sup> Ker najdbe pretežno izvirajo z območja stavbe 1, je tudi dobljene rezultate treba razumeti kot odraz specifičnih preferenc stanovalcev omenjene stavbe (območja) in ne najdišča v celoti.

Tab. 8.24: Število določenih primerkov (NISP) za posamezne taksonne velikih sesalcev iz Ajdovščine/*Castra*. Vir: lastni neobjavljeni podatki.

Tab. 8.24: Number of identifiable specimens (NISP) for individual large mammalian taxa from Ajdovščina/*Castra*. Source: personal unpublished data.

Takson / Taxon	NISP	% NISP
<i>Bos taurus</i>	156	37,7
<i>Sus</i> sp.	102	24,6
Caprinae	84	20,2
<i>Equus caballus</i>	62	15,0
<i>Cervus elaphus</i>	7	1,7
<i>Camelus dromedarius</i>	3	0,8
SKUPAJ / TOTAL	414	100,0

rial, especially in the modest representation of teeth, jawbones and skulls (MacKinnon 2004, 219). Such a picture is shown by cattle remains from the military post Dichin/*Nicopolis* in Bulgaria (Johnstone 2007, 292), however, as previously stated, this was not the case in Tonovcov grad.

A few additional words should be said in relation to the cattle butchering process. A detailed study of the frequencies and positions of the cut- and chop-marks on individual skeletal elements would be beyond the focus of this study. It is, however, worth noting that the epiphyses of cattle long bones are mainly undamaged. This is important, since cattle remains excavated at military camps tend to show a different picture reflecting a specific, much more patterned butchering procedure primarily aimed at producing equal portions (cf. Maltby 1989, 90; Riedel 1993b, 226 ff; Stokes 2000, 147). Due to the relatively little attention paid to the precise location of the chop or cut by the overworked military cooking personnel, the butchery waste often includes a large proportion of long bones with damaged epiphyses (cf. Riedel 1993b, 227).

The small numbers of bones damaged in such a way in the material from the Late Antiquity phase 1 of Tonovcov grad does not in itself exclude the possible presence of a military unit within the settlement. Similar holds true for the above presented data on the standardly low species richness and the lack of diachronic (i.e. inter-phase) variations in the share of cranial skeletal elements. Nevertheless, the data do give us at least an idea as regards the size of the (plausible) military unit, which apparently could not be very large. As such a small unit could perfectly satisfy their needs for food already with the local products (stock rearing and field crops), there would be no real need for a vast import of food, nor for routinized mass butchering (of cattle carcasses) or broadening of the diet by augmenting the role of game and/or fish (cf. Bartosiewicz 1990–1991).

kosti med gradivom iz prve faze poznoantične poselitve Tonovcovega gradu sicer sama po sebi še ne zanika morebitne prisotnosti vojaške posadke v naselbini. Enako velja tudi za zgoraj predstavljene podatke o zastopanosti zob in kosti glave ter o vrstnem bogastvu vzorca. Je pa iz navedenega mogoče sklepati vsaj na obseg (morebitne) vojaške posadke, ki ni mogla biti prav velika. Maloštevilno moštvo bi namreč svojim potrebam po hrani lahko brez večjih težav zadostilo že s produkti lokalne reje živine (in poljedelstva), izostala pa bi tudi potreba po množičnem, "avtomatiziranem" raztelesanju goved (zato manj poškodb epifiz dolgih kosti).

### 8.6.3 PRIMERJAVE V PROSTORU IN ČASU

Bistveno razliko med favnističnimi vzorci iz obeh poznoantičnih in zgodnjesevredneveške poselitvene faze Tonovcovega gradu predstavlja očiten upad deleža domačega goveda na račun drobnice po zatonu prve poznoantične faze (tab. 8.4–8.5). Kaj tiči v ozadju navedenega procesa, je težko oceniti, skoraj gotovo pa to ne dokazuje obsežnejšega uvoza teletine/govedine v naselbino v času prve poznoantične poselitvene faze (glej zgoraj). V kolikor gre favnistično sliko z izkopanega dela najdišča posplošiti na celotno naselbino, bi bilo večji delež goveda med gradivom iz prve poznoantične faze bolj utemeljeno pripisati večji vlogi govedoreje v lokalni ekonomiji v navedenem obdobju. Pri tem velja poudariti, da izkazujejo starejša rimskodobna najdišča v regiji še višjo relativno frekvenco pojavljanja najdb domačega goveda, kot je bilo to ugotovljeno za prvo poznoantično fazo s Tonovcovega gradu (sl. 8.33). Iz tega bi lahko sklepali, da je postalo vzdrževanje velikih čred uniparnih in razmeroma počasi rastočih goved z namenom prireje mesa v nemirnem obdobju pozne antike očitno ekonomsko premalo učinkovito, zato sta pomen pridobivala drobnica in prašič. Trend upadanja obsega govedoreje se je spričo naraščajoče politične in varnostne nestabilnosti v obdobju pozne antike nadaljeval tudi še v šestem in deloma sedmem stoletju, tj. za časa druge poznoantične poselitvene faze Tonovcovega gradu. Analogije lahko najdemo na praktično vseh sočasnih najdiščih v regiji (sl. 8.33), kar izpričuje podoben odziv posameznih lokalnih skupnosti jugovzhodnoalpskega prostora na "barbarsko" pretnjo z vzhoda.

Da je upad deleža goveda na prehodu iz prve faze poznoantične poselitve Tonovcovega gradu v drugo verjetno res v precejšnji meri odsev slabših varnostnih razmer, kažejo tudi podatki o frekvenci pojavljanja najdb osrednjih domestikativ na železnodobnih najdiščih v regiji. Ti namreč praviloma izkazujejo vsaj polovični delež zastopanosti goveda, po čemer se umeščajo znotraj variacijske širine za rimskodobna najdišča v jugovzhodnoalpskem prostoru (sl. 8.33), in to navkljub sicer še

### 8.6.3 COMPARISONS IN SPACE AND TIME

The main difference between the faunal assemblages from both Late Antiquity and the Early Medieval phase at Tonovcov grad is represented by the noticeable decline of cattle and the contemporaneous increase of caprines following the end of Late Antiquity phase 1 (Tabs. 8.4–8.5). It is hard to assess what stands behind this process, but it is almost certain that it does not reflect a considerable import of veal/beef during the Late Antiquity phase 1 (see above). In the event that the picture emerging from the analyses of animal remains from the excavated area is applicable to the entire settlement, the larger cattle share in the Late Antiquity phase 1 material would have rather to be attributed to the greater role played by cattle in the local economy of the time. It should be emphasised that earlier Roman period sites in the region show an even greater relative abundance of cattle finds than the Late Antiquity phase 1 at Tonovcov grad (Fig. 8.33). This could lead to the conclusion that during an unstable period of Late Antiquity maintaining large herds of uniparous and relatively slow growing cattle for meat production was obviously not economically efficient, thus sheep, goats and pigs were gaining in importance. Along with increasing political instability in Late Antiquity the declining trend in cattle exploitation continued also throughout the 6<sup>th</sup> and 7<sup>th</sup> century, i.e. during the time of Late Antiquity phase 2. Analogies can be found in practically all sites from that period in the region (Fig. 8.33), indicated by the similar response of individual local communities to the "barbarian" threat from the east.

The thesis of the decreased contribution of cattle during the transition between Late Antiquity phases 1 and 2 at Tonovcov grad being largely a reflection of the poorer safety conditions is corroborated by the data on the abundance of main domesticates at Iron Age sites in the Southeastern Alps. These tend to show an at least a 50 % share of cattle and thus fall within the range seen at Roman period sites in the same area (Fig. 8.33). This is noteworthy since Iron Age animal exploitation was based on the relatively archaic herding practices that differed greatly from Roman animal breeding (cf. Bökönyi 1974). At this it is important to state that amongst the Iron Age sites shown on figure 8.33 significant settlements (i.e. "centres") prevail (Dular, Tecco Hvala 2007, 191 ff). These were (together with the accompanying territories) politically and economically autarkic units, whose existence was based on a subsistence economy,<sup>78</sup> however the communication network enabled close contacts and a dynamic exchange between neighbouring settlements as well as with more distant places (Dular, Tecco Hvala

<sup>78</sup> Members of the local community (i.e. inhabitants of a centre with the accompanying territory) produced their own food, reared their own cattle and manufactured tools and vessels.

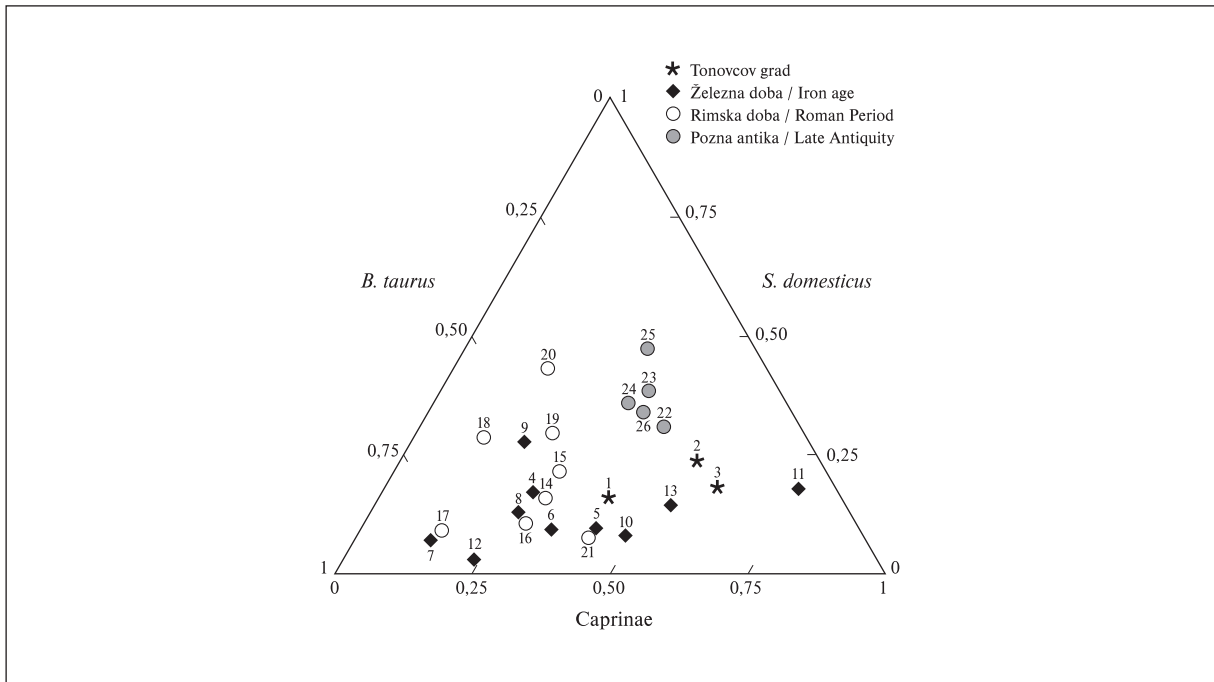

Sl. 8.33: Delež zastopanosti domačega goveda, drobnice in prašiča v treh tukaj obravnavanih poselitvenih fazah Tonovcovega gradu in še 23 drugih najdiščih s prostora jugovzhodnih Alp. Seznam vzorcev, njihova velikost (NISP) in časovna opredelitev:

1 – Tonovcov grad (prva poznoantična faza); 2 – Tonovcov grad (druga poznoantična faza); 3 – Tonovcov grad (zgodnjemedijeveška faza); 4 – Stična, Slovenija (železna doba; NISP = 4487; Bökönyi 1994); 5 – Kunkel, Slovenija (starejša železna doba; NISP = 282; Bartosiewicz 1996); 6 – Bled: pod Gradom, Slovenija (starejša železna doba; NISP = 347; Bartosiewicz 1996); 7 – Cvinger, Slovenija (starejša železna doba; NISP = 206; Bartosiewicz 1996); 8 – Gradec pri Vinkovem vrhu, Slovenija (starejša železna doba; NISP = 511; Bartosiewicz 1996); 9 – Libna, Slovenija (starejša železna doba; NISP = 130; Bartosiewicz 1996); 10 – Most na Soči, Slovenija (starejša železna doba; NISP = 2956; Bartosiewicz 1985); 11 – Nivize, Italija (železna doba; NISP = 158; Riedel 1968); 12 – Jama I na Prevali, Slovenija (železna doba; NISP = 947; Riedel 1977); 13 – Grgar-Grašišče, Slovenija (starejša železna doba; NISP = 130; neobjavljeno); 14 – Vrhnika/*Nauportus*, Slovenija (rimska doba; NISP = 189; neobjavljeno); 15 – Ribnica na Dolenjskem/*Romula*, Slovenija (rimska doba; NISP = 5876; neobjavljeno); 16 – Gorenje Skopice, Slovenija (rimska doba; NISP = 251; neobjavljeno); 17 – Col: telovadnica, Slovenija (rimska doba; NISP = 434; neobjavljeno); 18 – Draga, Slovenija (rimska doba; NISP = 142; neobjavljeno); 19 – Ajdovščina/*Castra*, Slovenija (rimska doba; NISP = 414; neobjavljeno); 20 – Altino, Italija (rimska doba; NISP = 732; Riedel 1985); 21 – Most na Soči, Slovenija (rimska doba; NISP = 484; Bartosiewicz 1986); 22 – Invillino, Italija (pozna antika; NISP = 3522; Stork, von den Driesch 1987); 23 – Ajdovski Gradec nad Vranjem, Slovenija (pozna antika; NISP = 2735; Bartosiewicz, Choyke 1985); 24 – Sv. Hema/Hammaberg, Avstrija (pozna antika; NISP = 704; Forstenpointner *et al.* 2002); 25 – Teriola, Avstrija (pozna antika; NISP = 356; Pucher 2003); 26 – Videm/Udine: grad, Italija (pozna antika; NISP = 1076; Riedel 1993b).

Fig. 8.33: The share of cattle, sheep/goats and pigs in three settlement phases at Tonovcov grad and 23 other sites in the Southeastern Alps. The list of samples, their size (NISP) and placement in time:

1 – Tonovcov grad (Late Antiquity phase 1); 2 – Tonovcov grad (Late Antiquity phase 2); 3 – Tonovcov grad (Early Medieval phase); 4 – Stična, Slovenia (Iron Age; NISP = 4487; Bökönyi 1994); 5 – Kunkel, Slovenia (Early Iron Age; NISP = 282; Bartosiewicz 1996); 6 – Bled: below the castle, Slovenia (Early Iron Age; NISP = 347; Bartosiewicz 1996); 7 – Cvinger, Slovenia (Early Iron Age; NISP = 206; Bartosiewicz 1996); 8 – Gradec pri Vinkovem vrhu, Slovenia (Early Iron Age; NISP = 511; Bartosiewicz 1996); 9 – Libna, Slovenia (Early Iron Age; NISP = 130; Bartosiewicz 1996); 10 – Most na Soči, Slovenia (Early Iron Age; NISP = 2956; Bartosiewicz 1985); 11 – Nivize, Italy (Iron Age; NISP = 158; Riedel 1968); 12 – Jama I on Preval, Slovenia (Iron Age; NISP = 947; Riedel 1977); 13 – Grgar-Grašišče, Slovenia (Early Iron Age; NISP = 130; unpublished); 14 – Vrhnika/*Nauportus*, Slovenia (Roman period; NISP = 189; unpublished); 15 – Ribnica na Dolenjskem/*Romula*, Slovenia (Roman period; NISP = 5876; unpublished); 16 – Gorenje Skopice, Slovenia (Roman period; NISP = 251; unpublished); 17 – Col: gym, Slovenia (Roman period; NISP = 434; unpublished); 18 – Draga, Slovenia (Roman period; NISP = 142; unpublished); 19 – Ajdovščina/*Castra*, Slovenia (Roman period; NISP = 414; unpublished); 20 – Altino, Italy (Roman period; NISP = 732; Riedel 1985); 21 – Most na Soči, Slovenia (Roman period; NISP = 484; Bartosiewicz 1986); 22 – Invillino, Italy (Late Antiquity; NISP = 3522; Stork, von den Driesch 1987); 23 – Ajdovski Gradec above Vranje, Slovenia (Late Antiquity; NISP = 2735; Bartosiewicz, Choyke 1985); 24 – Hammaberg, Austria (Late Antiquity; NISP = 704; Forstenpointner *et al.* 2002); 25 – Teriola, Austria (Late Antiquity; NISP = 356; Pucher 2003); 26 – Udine: castle, Italy (Late Antiquity; NISP = 1076; Riedel 1993b).

razmeroma primitivnim vzrejnim prijemom, ki so močno odstopali od napredne rimske prakse (cf. Bökönyi 1974). Pri tem je pomembno povedati, da med železnodobnimi najdišči s *slike* 8.33 prevladujejo pomembnejša naselja (Dular, Tecco Hvala 2007, 191 ss.). Ta so bila (skupaj s pripadajočim teritorijem) politično in ekonomsko sicer avtarkične enote, katerih obstoj je temeljil na subsistenčnem gospodarstvu,<sup>76</sup> je pa komunikacijska mreža omogočala tesne stike in živahno menjavo med sosednjimi naselji pa tudi bolj oddaljenimi kraji (Dular, Tecco Hvala 2007, 229 ss.). Drugače povedano: spričo pretežno<sup>77</sup> stabilnih političnih in varnostnih razmer je železnodobnim skupnostim na območju jugovzhodnih Alp (v nasprotju s poznoantičnimi) domnevno uspelo vzpostaviti centralizirano oskrbo s teletino/govedino, kar se med drugim kaže tudi v prevladi govejih najdb znotraj tamkajšnjih favnističnih vzorcev.

## 8.7 SKLEP

V tem poglavju predstavljeno gradivo s Tonovcovega gradu sodi med najbogatejše arheozoološke vzorce s Slovenskega in ob žal še neobjavljeni študiji živalskih ostankov z Ajdovskega gradca nad Vranjem (Bartosiewicz, Choyke 1985) tudi daleč najboljše najstarejši favnistični vzorec poznoantične starosti. Kot tak je izvrstna priložnost za poglobljen vpogled v ekonomijo in prehranske navade prebivalcev lokalnega centra v obdobju med koncem 4. in 8. (morda tudi 9.) stoletjem.

Sodeč po tukaj predstavljenih rezultatih je bil Tonovcov grad ekonomsko avtarkična enota, katere obstoj je v veliki meri temeljil na subsistenčnem gospodarstvu. Med domačimi živalmi je osrednja vloga pripadala domačemu govedu, ki pa so ga primarno izkoriščali za delo na poljih oz. v transportu. Starostna struktura za omenjeno vrsto namreč kaže na preferenčen zakol več kot tri leta starih živali. Pomen domačega goveda se je na prehodu iz prve poznoantične poselitvene faze v drugo nekoliko zmanjšal na račun drobnice (domnevno predvsem ovce), kar razlagava z naraščajočo politično in varnostno nestabilnostjo na območju jugovzhodnoalpskega prostora.

Govedu je kot drugi ekonomsko najpomembnejši takson sledila drobnica, sicer prevladujoča po skupnem številu določenih najdb. Sodeč po razmerju med specifično določenimi primerki poddružine Caprinae so bile ovce številčnejše od koz. V obdobju druge poznoantične faze je drobnica predstavljala predvsem vir

<sup>76</sup> Člani srenje (tj. središča s pripadajočim teritorijem) so si sami pridelovali hrano, redili živino ter izdelovali orodje in posodje.

<sup>77</sup> Domnevno edini res krizni epizodi v obdobju železne dobe na Slovenskem so bili roparski vpadi tolpe skitskega poretka v prvi polovici 6. stoletja pr. n. št. ter prihod keltskih Tavrisikov ob koncu 4. stoletja pr. n. št. (Dular, Tecco Hvala 2007, 251 s.).

2007, 229 ff.). Due to the predominantly<sup>79</sup> stable political conditions and security, Iron Age communities living southeast of the Alps (in opposition to the Late Antique ones) presumably established a centralised provisioning system of veal/beef, which is among others reflected in the dominance of cattle finds in the faunal assemblages from the area.

As far as the rest of the animal products are concerned, the question of whether they were produced/consumed locally (as a form of subsistence) remains without a definitive answer. As discussed in chapter 8.6.1, the mortality profile for caprines seems to be indicative of a local production of meat, milk and (as far as the Late Antiquity phase 1 is concerned) wool. Similar holds true for pigs, which were reared exclusively for meat (and fat). It is thus interesting to note, that no statistically significant differences in skeletal representation of individual carcass parts between Late Antiquity phase 1 and 2 were observed (Mann-Whitney U test:  $p > 0.05$ ), even though the latter shows a much higher number of skull fragments (*Tab.* 8.18). Of course, at a different location within the same settlement the results might be (even very) different ...

## 8.7 CONCLUSIONS

The material from Tonovcov grad is among the richest faunal assemblages revealed by archaeological excavations in Slovenia and alongside the unfortunately still unpublished study of animal remains from Ajdovski gradec above Vranje (Bartosiewicz, Choyke 1985) also the most abundant faunal assemblage from the Late Antique period. As such it offers an excellent opportunity for a detailed insight into the local economy and the diet of the inhabitants of a local centre between the end of the 4<sup>th</sup> to the 8<sup>th</sup> (and maybe even the 9<sup>th</sup>) century.

From the results presented in this chapter it seems that Tonovcov grad was an economically autarkic unit, whose existence was to a great extent based on subsistence economy. Amongst domesticates the central role belonged to cattle, which was primarily used as beast of burden. The mortality profile shows that cattle were mainly culled once they were over three years old. The importance of cattle was slightly reduced due to an increase in the exploitation of caprines (hypothetically mainly sheep) at the transition from the Late Antiquity phases 1 and 2. This can be explained by the increased political and security instability in the southeastern Alpine area at that time.

<sup>79</sup> The only presumed crises in the territory of present-day Slovenia in the Iron Age is represented by the pillaging of the Skiiit tribes in the first half of the 6<sup>th</sup> century BC and the arrival of the Celtic Tavrisks at the end of the 4<sup>th</sup> century BC (Dular, Tecco Hvala 2007, 251 f.).



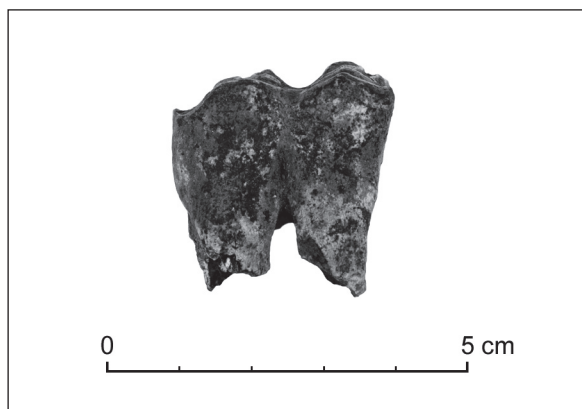

mesa<sup>78</sup> in mleka;<sup>79</sup> prireja volne naj bi bila nekoliko bolj v ozadju. Slika, ki jo kaže prva poznoantična poselitev obravnavanega najdišča, je nekoliko bolj zamegljena. V korigirani starostni strukturi bi se namreč lahko odražal bodisi nekoliko večji poudarek na prireji volne bodisi uvoz mesa odraslih ovac/koz za prehrano.

Domači prašič po številu najdb (in pomenu) zaostaja tako za govedom kot tudi drobnico. Temu je verjetno v precejšnji meri botroval relief območja, saj so za rejo prašičev manj primerna tako suha tla na obravnavanem delu razmeroma ozke Soške doline kot tudi strma pobočja okoliških vzpetin. Prašičereja je bila sicer v skladu s pričakovanji usmerjena izključno v prirejo mesa in maščob. Nasprotno sliko kažejo konj in pes, katerih mesa prebivalci Tonovcovega gradu najverjetneje niso uživali. Prvi je bil pomemben predvsem kot tovarna žival in za jezdenje (sl. 8.34), drugi kot čuvaj čred, ljudi in imetja. Prebivalci Tonovcovega gradu so se ukvarjali tudi z lovom, čeprav iz skromnega deleža zastopanosti jelenjadi, srnjadi in drugih lovnih vrst sicer izhaja, da ta ni predstavljal omembe vrednega segmenta takratne ekonomije.

Ob najdbah sesalcev so bili med živalskimi ostanki s Tonovcovega gradu zastopane tudi kosti ptic, skoraj izključno domačih kokoši (glej pogl. 9, tab. 9.1). Podatek se lepo sklada s tezo o Tonovcovem gradu kot ekonomsko avtarkični naselbini, temelječi na subsistenčnem gospodarstvu, saj je kokoš (perutnina) v očeh takratnega prebivalstva nedvomno predstavljala vzrejno nezahteven vir razmeroma kvalitetnega mesa (cf. MacKinnon 2004, 210). Pomenljive so tudi najdbe trnkov (glej pogl. 2.1). V tej luči lahko kot pričakovane razumemo tudi rezultate analize velikosti osrednjih taksonov domestikator: čeprav obdelano gradivo vključuje tudi posamezne primerke velikih "rimskih" oblik (pasem?), večino najdb namreč vendarle predstavljajo kosti in zobje tradicionalnega lokalnega goveda oz. drobnice.

Nekateri arheološki podatki kažejo, da je bila med prvo poznoantično poselitveno fazo Tonovcovega gradu v naselbini morda nastanjena vojaška posadka (glej pogl.

<sup>78</sup> To naj bi veljalo še posebej za ovce.

<sup>79</sup> V tem pogledu naj bi bile pomembnejše koze.

Sl. 8.34: Drugi spodnji predmeljak konja iz vzorca št. 547 (kv. 619; mkv. C2) s Tonovcovega gradu. Na zobu je vidna značilna obraba grizalne površine zaradi grizenja žvale (cf. Brown, Anthony 1998). Slika: M. Zaplatil.

Fig. 8.34: The second lower horse premolar from sample No. 547 (sq. 619; msq. C2) from Tonovcov grad. The tooth surface shows typical ware pattern as a result of chewing the bit (cf. Brown, Anthony 1998). Photo: M. Zaplatil.

The second economically most important taxa (following cattle) were sheep and goats, which dominated by the total number of identifiable finds. In Late Antiquity phase 2 caprines were reared predominantly as a source of meat<sup>80</sup> and milk,<sup>81</sup> while wool production may not have been as important. The situation during the Late Antiquity phase 1 is less clear: the corrected mortality profile could indicate either a slightly higher emphasis on wool production or imports of adult sheep/goat meat for food.

According to the number of finds (and thus supposed importance) pig lagged behind cattle and caprines. This is to a great extent a reflection of the relief of the terrain, as pig rearing is less suitable on the dry grounds of the relatively narrow Soča Valley, or the steep slopes of the surrounding hills. In accordance to our expectations pig exploitation was oriented exclusively into meat and fat production. An opposite picture is shown by small number of horse and dog remains, as it is highly unlikely that the inhabitants of Tonovcov grad (regularly) enjoyed their meat. Horse was important mainly as a beast of burden (Fig. 8.34), while dog was useful in guarding herds, people and property. The inhabitants of Tonovcov grad also hunted, even though the modest shares of deer and other game indicate that hunting did not represent a quantitatively important segment in their economy.

Animal remains at Tonovcov grad also included bird bones, almost exclusively belonging to domestic hen (see chapter 9, Tab. 9.1). This seems to confirm the thesis that Tonovcov grad was an economically autarkic settlement, based on a subsistence economy, for hen (poultry) undoubtedly represented an undemanding source of relatively high quality meat for the inhabitants (cf. MacKinnon 2004, 210). Finds of fish hooks also offer important evidence of angling (see chapter 2.1).

Certain archaeological data indicate that during the Late Antiquity phase 1 Tonovcov grad may have housed a military unit (see chapters 2.1, 4.1).

<sup>80</sup> Supposedly this holds especially true for sheep.

<sup>81</sup> In this sense goats were more important.

2.1, 4.1). Žal na podlagi zgoraj predstavljenih rezultatov analize favnističnega gradiva navedene teze ni mogoče niti potrditi niti zanikati. Se pa na podlagi podatkov o vrstnem bogastvu vzorcev vsake od treh tukaj obravnavanih poselitvenih faz, predvsem pa iz deležev zastopanosti skeletnih elementov in njihove ohranjenosti dozdeva, da je vojaška posadka (v kolikor je bila v naselbini dejansko nastanjena) obsegala razmeroma skromno število vojakov. Z začetkom druge poznoantične faze je Tonovcov grad postopoma pridobival pomen kot osrednja naselbina na območju med Nadižo in Sočo ter lokalno cerkveno središče, kar bi lahko prispevalo k izrazitejšemu socialnemu razslojevanju prebivalstva. Določene razlike med jedilnikom stanovalcev osrednjega prostora stavbe 1 in prehrano tistih iz njegovega prizidka je ne nazadnje izpostavila tudi favnistična analiza. Razpoložljivi podatki sicer resda kažejo na to, da so prebivalci Tonovcovega gradu v veliki meri uživali meso istih vrst živali, ne da bi posamezniki/skupine z višjim statusom pogosteje posegali po okusnejšem in bolj cenjenem (cf. MacKinnon 2004, 205 s) mesu mladih živali. Se je pa zato na krožniku slednjih (glej npr. stavbo 1; sl. 8.14) relativno pogosto znašlo meso najkvalitetnejših delov trupa, medtem ko med ostanki hrane njihovih služabnikov močno prevladujejo kosti iz bistveno manj cenjenih spodnjih delov okončin in glave. Še bolj kot v stavbi 1 pa so bili ostanki najbolj mesnatih delov trupa zastopani v prostoru med cerkvami. Žal razpoložljivi arheološki podatki namembnosti tega prostora za časa druge poznoantične poselitvene faze Tonovcovega gradu ne izkazujejo, "prestižen" nabor najdenih kostnih ostankov pa vendar še dodatno nakazuje obstoj določene socialne razslojenosti v obravnavani naselbini.

Unfortunately, the analysis of the faunal material does not lead to a confirmation or rejection of this thesis. Nevertheless, on the basis of taxonomic richness in all three settlement phases, and especially the frequencies of individual skeletal elements and their preservation it seems that the military unit (in the event that it really was stationed within the settlement) consisted of a relatively few soldiers. With the beginning of the Late Antiquity phase 2 Tonovcov grad gradually started gaining on importance as the central settlement in the area between the Nadiža and Soča rivers. It was also a local religious centre, which may also have contributed to a more expressed social diversification of its inhabitants. As a matter of fact, certain differences in the diet of the inhabitants from Tonovcov grad were indeed observed, which may be a result of social stratification (Figs. 8.10-8.12, 8.14). Namely, the diet of the higher standing social strata (see for instance building 1; Fig. 8.14) were more likely to include the meat of the highest quality carcass parts, leaving their servants to cope with the much less meaty lower parts of extremities and the head. The highest concentration of the remains from the carcass parts richest in meat was detected in the area between the central and the south churches. Unfortunately, the archaeological data available do not allow for an unambiguous interpretation of the purpose of the structure standing at this spot during the Late Antiquity phase 2, however such a rich assemblage of animal bones offers yet another indication of social stratification within the settlement.

## 8.8 LITERATURA / BIBLIOGRAPHY

Tonovcov grad. Naselbinski ostanki in interpretacija / Tonovcov grad. Settlement remains and interpretation = Ciglencečki, Modrijan, Milavec 2011.

ALBARELLA, U. 2002, 'Size matters': how and why biometry is still important in zooarchaeology. – V / In: K. Dobney, T. O'Connor (ur. / eds.), *Bones and the man*, 51–62, Oxford.

ANDRIČ, M. in / and K.J. WILLIS 2003, The phytogeographical regions of Slovenia: a consequence of natural environmental variation or prehistoric human activity? – *Journal of Ecology* 91, 807–821.

BAKER, P. 1991, Fauna. – V / In: G.P. Broglio, L. Castelletti (ur. / eds.), *Archeologia a Monte Barro I. Il grande edificio e le torri*, 153–258, Lecco.

BAKER, P. in / and G. CLARK 1993, Archaeozoological evidence for medieval Italy: a critical review of

the present state of research. – *Archeologia Medievale* 20, 45–78.

BARTOSIEWICZ, L. 1984, Reconstruction of prehistoric cattle represented by astragali in a Bronze age "sacrificial pit". – C. Grigson, J. Clutton-Brock (ur. / eds.), *Animals and archaeology. Part IV: Husbandry in Europe*, BAR. International series 227, 64–80, Oxford.

BARTOSIEWICZ, L. 1985, Most na Soči: a preliminary faunal analysis of the Hallstatt Period settlement. – *Arheološki vestnik* 36, 107–131.

BARTOSIEWICZ, L. 1986, Roman Period animal remains from Most na Soči. – *Arheološki vestnik* 37, 287–296.

BARTOSIEWICZ, L. 1990–1991, Animal bones as indicators of continuity at Roman provincial sites. – *Antaeus* 19–20, 103–124.

BARTOSIEWICZ, L. 1996, Continuity in the animal keeping of Hallstatt Period communities in

Slovenia. – V / In: E. Jerem, A. Lippert (ur. / eds.), *Die Osthallstattkultur*, Archaeolingua 7, 29–35, Budapest.

BARTOSIEWICZ, L. 1998, Medieval animal bones from the castle of Váralja-Várfő (Western Hungary). – *A Wosinsky Mór Múzeum Évkönyve* 20, 157–172.

BARTOSIEWICZ, L. 2002, Unburned animal remains in the cremation graves from Tolmin. – V / In: D. Svoljšak, A. Pogačnik (ur. / eds.), *Tolmin, prazgodovinsko grobišče II. Razprave (Tolmin, the prehistoric cemetery II. Treatises.)*, Catalogi et Monographiae 35, 133–135, Ljubljana.

BARTOSIEWICZ, L. in / and A.M. CHOYKE, 1985, Animal bones from the 5th–6th century settlement at Ajdovski gradec. – Neobjavljeno poročilo / Unpublished report. Hrani / capt at: Iza ZRC SAZU, Ljubljana.

BENECKE, N. 2005/2006, The Holocene distribution of European bison – the archaeozoological record. – *Munibe* 57, 421–428.

BOESSNECK, J., J.-P. JÉQUIER in / and H.R. STAMPFLI 1963, Seeberg, Burgäschisee-Süd. Die Tierreste. – *Acta Bernensia* 2, Bern.

BÖKÖNYI, S. 1974, *History of domestic mammals in Central and Eastern Europe*. – Budapest.

BÖKÖNYI, S. 1984, *Animal husbandry and hunting in TÁC-Gorsium. The vertebrate fauna of a Roman town in Pannonia*. – Budapest.

BÖKÖNYI, S. 1986, Animal remains from the Roman Forum of Sopron-Scarbantia. – *Acta Archaeologica Academiae Scientiarum Hungaricae* 38, 397–422.

BÖKÖNYI, S. 1994, Analiza živalskih kosti. (Die Tierknochenfunde). – V / In: S. Gabrovec, *Stična I. Naselbinska izkopavanja (Stična I. Siedlungsausgrabungen)*, Katalogi in monografije 28, 190–213, Ljubljana.

BON, M., G. PICCOLI in / and B. SALA 1991, I giacimenti Quaternari di vertebrati fossili nell'Italia nord-orientale. – *Memorie di Scienze Geologiche* 43, 185–231.

BOSCHIN, F. in / and M. WEISSTEINER 2007, Una casa datata alla prima età Romana imperiale scavata a Elvas presso Bressanone. Lo studio della Fauna. – *Annali del Museo civico di Rovereto, Sezioni Archeologia, Storia, Scienze naturali* 23, 3–34.

BOSIO, L. 1991, *Le strade romane della Venetia e dell'Histria*. – Padova.

BRADAČ, F. B. GRAFENAUER in / and K. GANTAR (prevajalci / translators) 1988, *Pavel Diakon (Paulus Diaconus): Zgodovina Langobardov (Historia Langobardorum)*. – Maribor.

BROWN, D. in / and D. ANTHONY 1998, Bit wear, horseback riding and the Botai site in Kazakstan. – *Journal of Archaeological Science* 25, 331–347.

CAHIX, L. in / and R.-M. ARBOGAST 1999, Holocene aurochs from Western Europe: osteometric data. – V / In: G.C. Weniger (ur. / ed.), *Archäologie und Biologie des Auerochsen*, Wissenschaftliche Schriften des Neanderthal Museums 1, 35–48, Mettmann.

CIGLENEČKI, S. 1997a, Die wichtigsten Völkerwanderungszeitlichen Einfallstrassen von Osten nach Italien im Licht der neuesten Forschungen. – *Peregrinatio Gothica (Supplementum ad Acta Musei Moraviae)*, 179–191.

CIGLENEČKI, S. 1997b, Poznoantični in slovanski sledovi na Kobariskem. – *Kobarid*, 17–28.

CIGLENEČKI, S. 2005, L'insediamento fortificato su altura di Tonovcov grad presso Caporetto e i suoi dintorni in età romana e paleo-slava. – V / In: A. Tilati (ur. / ed.), *La christianizzazione degli Slavi nell'arco Alpino orientale (secoli VI-IX)*, 93–108, Gorizia.

CIGLENEČKI, S., Z. MODRIJAN in / and T. MILAVEC 2011, *Poznoantična utrjena naselbina Tonovcov grad pri Kobaridu. Naselbinski ostanki in interpretacija / Late Antique fortified settlement Tonovcov grad near Kobarid. Settlement remains and interpretation*. – Opera Instituti Archaeologici Sloveniae 23.

CLEGHORN, N. in / and C.W. MAREAN 2004, Distinguishing selective transport and *in situ* attrition: a critical review of analytical approaches. – *Journal of Taphonomy* 2(2), 43–67.

CRIBB, R. 1984, Computer simulation of herding systems as an interpretative heuristic device in the study of kill-off strategies. – V / In: J. Clutton-Brock, C. Grigson (ur. / eds.), *Animals and archaeology. Part III: Early herders and their flocks*, BAR. International series 202, 161–170, Oxford.

CULIBERG, M. 1995, Dezertifikacija in reforestacija slovenskega Krasa. – *Poročilo o raziskovanju paleolitika, neolitika in eneolitika v Sloveniji* 12, 201–215.

CULIBERG, M. in / and A. ŠERCELJ 1995, Antrakotomske in karpološke raziskave rastlinskih ostankov s Kučarja. (Anthrakotomische und karpologische Untersuchungen der Pflanzenreste vom Kučar.) – V / In: J. Dular, S. Ciglencečki, A. Dular, *Kučar. Železnodobno naselje in zgodnjekrščanski stavbni kompleks na kučarju pri Podzemlju / Kučar. Eisenzeitliche Siedlung und frühchristlicher Gebäudekomplex auf dem Kučar bei Podzemelj*, Opera Instituti Archaeologici Sloveniae 1, 195–200, Ljubljana.

DAKSKOBLER, I. 1996, Združba Seslerio autumnalis-Fagetum (Ht.) M. Wraber ex Borhidi 1963 v Koprskem gričevju. – *Annales* 9, *Series historia naturalis* 3, 181–200.

DAKSKOBLER, I. 2004, Združbe črnega gabra (*Ostrya carpinifolia*) v Srednjem Posočju (Zahodna Slovenija). – *Razprave IV. razreda SAZU* 45(2), 37–146.

DI MARTINO, S. 2002, Resti ossei animali bruciati. – V / In: D. Svoljšak, A. Pogačnik (ur. / eds.), *Tolmin, prazgodovinsko grobišče II. Razprave (Tolmin, the prehistoric cemetery II. Treatises.)*, Catalogi et Monographiae 35, 131, Ljubljana.

DRIESCH, A. von den 1976, A guide to the measurement of animal bones from archaeological sites. – *Peabody Museum Bulletin* 1, 1–136.

DULAR, J. in / and S. TECCO HVALA 2007, *Jugovzhodna Slovenija v starejši železni dobi. Poselitev, gospodarstvo, družba / South-Eastern Slovenia in the Early Iron Age. Settlement, economy, society.* – Opera Instituti Archaeologici Slovenia 12, Ljubljana.

ERVYNCK, A. 2004, The diet of the three orders in the feudal society of medieval north-western Europe. – V / In: S.J. O'Day, W. Van Neer, A. Ervynck (ur. / eds.), *Behaviour behind bones. The zooarchaeology of ritual, religion, status and identity*, 215–223, Oxford.

FORSTENPOINTNER, G., K. BAUER, G. GAGGL in / and G. WEIßENGRUBER 2002, Die Tierreste. – V / In: G. Forstenpointner, S. Ladstätter, R. Sauer in U. Thanheiser, Fernab der Pilger. Zum Alltagsleben in der spätantiken Siedlung auf dem Hemmaberg, *Jahreshefte des Österreichischen Archäologischen Institutes in Wien* 71, 39–78.

GAUTIER, A. 1984, How do I count you, let me count the ways? Problems of archaeozoological quantifications. – V / In: C. Grigson, J. Clutton-Brock (ur. / eds.), *Animals and archaeology. Part IV: Husbandry in Europe*, BAR. International Series 227, 237–251, Oxford.

GRANT, A. 1982, The use of tooth wear as a guide to the age of domestic ungulates. – V / In: B. Wilson, C. Grigson, S. Payne (ur. / eds.), *Ageing and sexing animal bones from archaeological sites*, BAR. British series 109, 91–108, Oxford.

GRAYSON, D.K. 1984, *Quantitative zooarchaeology.* – Orlando etc.

GRAYSON, D.K. in / and C.J. FREY 2004, Measuring skeletal part representation in archaeological faunas. – *Journal of Taphonomy* 2(1), 27–42.

GREENFIELD, H.J. 1988, Bone consumption by pigs in a contemporary Serbian village: implications for the interpretation of prehistoric faunal assemblages. – *Journal of Field Archeology* 15, 473–479.

GUINARD, C. 1999, On the size of the ure-ox or the aurochs (*Bos primigenius* Bojanus, 1827). – V / In: G.-C. Weniger (ur. / ed.), *Archaeology and biology of the aurochs*, Wissenschaftliche Schriften des Neanderthal Museum 1, 7–21, Köln.

JOHNSTONE, C. 2007, A short report on the preliminary results from the study of the mammal and bird bone assemblages from Dichin. – *Proceedings of the British Academy* 141, 287–294.

KENT, S. 1981, The dog: an archaeologist's best friend or worst enemy – the spatial distribution of faunal remains. – *Journal of Field Archeology* 8(3), 367–381.

KING, A. 1984, Animal bones and the dietary identity of military and civilian groups in Roman Britain, Germany and Gaul. – *Military and civilian in Roman Britain. Cultural relationships in a frontier province*, BAR. British Series 136, 187–217, Oxford.

KOBRYŃ, H., S. SERWATKA in / and K. ŚWIEŻYŃSKI 1984, Charakterystyka morfologiczna szczątków bydła z Wykopalisk archeologicznych na

terenie średniowiecznego grodu w Kaliszu-Zawodziu. – *Archeologia polski* 29, 399–413.

KRYŠTUFEK, B. 1991, *Sesalci Slovenije.* – Ljubljana.

KRŽE, B. 1982, *Divji prašič. Biologija in gospodarjenje.* – Zlatorogova knjižnica 13, Ljubljana.

LAM, Y.M., X. CHEN, C.W. MAREAN in / and C.J. FREY 1998, Bone density and long bone representation in archaeological faunas: comparing results from CT and photon densitometry. – *Journal of Archaeological Science* 25, 559–570.

LEMEN, C.A. 1983, The effectiveness of the methods of shape analysis. – *Fieldiana Zoology* 15, 1–17.

LUFF, R.-M. 1982, *A zooarchaeological study of the Roman North-western Provinces.* – BAR. International Series 137, Oxford.

LYMAN, R.L. 1999, *Vertebrate taphonomy.* – Cambridge.

MACKINNON, M. 2004, Production and consumption of animals in Roman Italy: integrating the zooarchaeological and textual evidence. – *Journal of Roman Archaeology, Supplementary Series* 54, 1–264.

MALTBY, J.M. 1982, The variability of faunal samples and their effects on ageing data. – V / In: B. Wilson, C. Grigson, S. Payne (ur. / eds.), *Ageing and sexing animal bones from archaeological sites*, BAR. British series 109, 81–90, Oxford.

MALTBY, M. 1989, Urban rural variations in the butchering of cattle in Romano-British Hampshire. – V / In: D. Serjeantson, T. Waldron (ur. / eds.), *Diet and Crafts in Towns, The evidence of animal remains from the Roman to the Post-Medieval periods*, BAR. British Series 199, 75–106, Oxford.

MAREAN, C.W. in / and L.M. SPENCER 1991, Impact of carnivore ravaging on zooarchaeological measures of element abundance. – *American Antiquity* 56(4), 654–658.

MARTIN, T. 1987, Artunterschiede an den Langknochen großer Artiodactyla des Jungpleistozäns Mitteleuropas. – *Courier Forschungsinstitut Senckenberg* 96, 1–124.

MATOLCSI, J. 1970, Historische Erforschung der Körpergröße des Rindes auf Grund von ungarischem Knochenmaterial. – *Zeitschrift für Tierzüchtung und Züchtungsbiologie* 87(2), 89–137.

MAY, E., M. TEICHERT in / and K. HANNE-MANN 1996, Allometric aspects to the determination of the withers height in pigs on the basis of the data of M. Teichert. – *Archaeozoologia* 8(1, 2), 125–137.

MIRACLE, P. in / and L. PUGSLEY 2006, Vertebrate faunal remains from Pupičina Cave. – V / In: P.T. Miracle, S. Forenbaher (ur. / eds.), *Prehistoric herders of Northern Istria*, Monografije i katalozi 14, 259–399, Pula.

MODRIJAN, Z. 2007, The Late Antique settlement Tonovcov grad near Kobarid: excavations 2002–2005. – V / In: M. Chiabà, P. Maggi, C. Magrini (ur. / eds.),

*Le Valli del Natisone e dell'Isonzo tra Centroeuropa e Adriatico. Atti del convegno internazionale di studi, San Pietro al Natisone (UD), 15-16 settembre 2006, Studi e ricerche sulla Gallia Cisalpina 20, 175–180, Trieste, Roma.*

MORAN, N.C. in / and T.P.O'CONNOR 1994, Age attribution in domestic sheep by skeletal and dental maturation: a pilot study of available sources. – *International Journal of Osteoarchaeology* 4, 267–285.

MUNSON, P.J. 2000, Age-correlated differential destruction of bones and its effect on archaeological mortality profiles of domestic sheep and goats. – *Journal of Archaeological Science* 27, 391–407.

O'CONNOR, T.P. 1991, *Bones from 46-54 Fishergate*. – *Archaeology of York* 15(4), London.

OUTRAM, A.K. 2004, Applied models and indices vs. high-resolution, observed data: detailed fracture and fragmentation analyses for the investigation of skeletal part abundance patterns. – *Journal of Taphonomy* 2(3), 167–184.

PAYNE, S. 1973, Kill-off patterns in sheep and goats: the mandibles from Aşvan Kale. – *Anatolian studies* 23, 281–303.

PAYNE, S. 1987, Reference codes for wear stages in the mandibular cheek teeth of sheep and goats. – *Journal of Archaeological Science* 14, 609–614.

PAYNE, S. in / and P. MUNSON 1985, Ruby and how many squirrels? The destruction of bones by dogs. – V / In: N.R.J. Fieller, D.D. Gilbertson, N.G.A. Ralph (ur. / eds.), *Palaeobiological investigations*, BAR. International Series 266, 31–40, Oxford.

PAYNE, S. in / and G. BULL 1988, Components of variation in measurements of pig bones and teeth, and the use of measurements to distinguish wild from domestic pig remains. – *Archaeozoologia* 2(1,2), 27–65.

PETERS, J. 1998, *Römische Tierhaltung und Tierzucht*. – *Passauer Universitätsschriften zur Archäologie* 5, Rahden.

PRAT, F. 1966, Les capridés. – V / In: R. Lavocat (ur. / ed.), *Atlas de Préhistoire, Tome III: Faunes et flores Préhistoriques de l'Europe occidentale*, 279–300, Paris.

PUCHER, E. 1993, Ein kleiner, spätantiker Knochenfundkomplex vom Kappele ob Jadersdorf, Gemeinde Gitschtal, Kärnten. – V / In: S. Felgenhauer-Schmiedt (ur. / ed.), *Das Kappele ('die Kåpile') ob Jadersdorf. Eine spätantik-frühmittelalterliche Höhensiedlung in Oberkärnten*, 51–55, Klagenfurt.

PUCHER, E. 2003, Ein kleiner Tierknochenfundkomplex aus dem spätrömischen Kastell Teriola auf dem Martinsbühel bei Zirl in Tirol. – V / In: A. Höck (ur. / ed.), *Archäologische forschungen in Teriola* 1, 91–99, Wien.

PUCHER, E. in / and K. ENGL 1997, *Studien zur Pfahlbauforschung in Österreich. Materialien I. Die Pfahlbaustationen des Mondsees. Tierknochenfunde*. – *Mitteilungen der Prähistorischen Kommission* 33, Wien.

RAKOVEC, I. 1973, Razvoj kvartarne sesalske favne v Sloveniji. (Über quartäre Säugetierfaunen Sloweniens [NW Jugoslawien].) – *Arheološki vestnik* 24, 217–270.

RIEDEL, A. 1968, I mammiferi domestici del castelliere di Nivize nel Carso Triestino. – *Atti e memorie della Commissione grotte "Eugenio Boegan"* 8, 125–144.

RIEDEL, A. 1977, I resti animali della Grotta delle Ossa (Škocjan). – *Atti del Museo civico di Storia naturale, Trieste* 30(2), 125–208.

RIEDEL, A. 1979, La fauna degli scavi di Torcello (1961-62). – *Atti del Museo Civico di Storia Naturale di Trieste* 31(2), 75–154.

RIEDEL, A. 1983, Tierfunde einer römischen Fundstätte von Innichen. – *Padusa* 19(1–4), 3–18.

RIEDEL, A. 1984, The Paleovenetian horse of Le Brustolade (Altino) – *Studi Etruschi* 50, ser. III, 227–256.

RIEDEL, A. 1985, Die Fauna von Altino (Venetien) im Verhältnis zu den Faunen Nordostitaliens und der Alpenländer. – *Razprave IV. razreda SAZU* 26, 131–146.

RIEDEL, A. 1986, Risultati di ricerche archeozoologiche eseguite nella regione fra la costa adriatica ed il crinale alpino (dal Neolitico recente al Medio Evo). – *Padusa* 22 (1–4), 1–220.

RIEDEL, A. 1989, The wild animals of Northeastern Italy from Neolithic to Medieval times: an archaeozoological comment. – *Natura Bresciana, Annali del Museo Civico di Storia Naturale Brescia* 26, 311–330.

RIEDEL, A. 1993a, Die Tierknochenfunde des römischen Lagerbaus von Traismauer/Augustiana in Niederösterreich. – *Annalen des Naturhistorischen Museums in Wien, Serie A* 95, 179–294.

RIEDEL, A. 1993b, Tierknochenfunde aus den Ausgrabungen im Bereich des Schlosses von Udine (Friaul). – *Aquileia Nostra* 64, 70–106.

RIEDEL, A. 1994a, The animal remains of Medieval Verona: an archaeozoological and palaeoeconomical study. – *Memorie del Museo Civico di Storia Naturale di Verona (IIª serie), Sezione scienze dell'uomo* 3, 1–141.

RIEDEL, A. 1994b, Archaeozoological investigations in North-eastern Italy: the exploitation of animals since the Neolithic. – *Preistoria Alpina* 30, 43–94.

RIEDEL, A. 2003, Die frühbronzezeitliche fauna von Brixlegg in Tirol. – *Atti dell'Accademia Roveretiana degli Agiati, Contributi della Classe di Scienze Matematiche, Fisiche e Naturali*, ser. 8, vol. 3, B: 197–281.

RIEDEL, A. 2004, Tierknochen aus der römischen Villa rustica von Nickelsdorf im Burgenland (Österreich). – *Annalen des Naturhistorischen Museums in Wien* 106A, 449–539.

RIEDEL, A. 2007, Ein spätantiker Tierknochenfundkomplex aus Drösing an der March (Niederösterreich). – *Annalen des Naturhistorischen Museums in Wien* 109A, 29–72.

RIEDEL, A. in / and G. SCARPA 1988, Resti animali di un complesso produttivo di età tardoromana a

Volano. – *Annali del Museo civico di Rovereto, Sezioni Archeologia, Storia, Scienze naturali* 4, 37–54.

ROLETT, B.V. in / and M.-Y. CHIU 1994, Age estimation of prehistoric pigs (*Sus scrofa*) by molar eruption and attrition. – *Journal of Archaeological Science* 21, 377–386.

SALA, B. 1986, *Bison schoetensacki* Freud. from Isernia la Pineta (early Mid-Pleistocene – Italy) and revision of the European species of bison. – *Palaeontographia Italica* 74, 113–170.

SCOTT, K.M. 1990, Postcranial dimensions of ungulates as predictors of body mass. – V / In: J. Damuth, B.J. Macfadden (ur. / eds.), *Body size in mammalian paleobiology*, 301–336, Cambridge.

SILVER, A. 1972, The aging of domestic animals. – V / In: D. Brothwell in E. Higgs (ur. / eds.), *Science in archaeology. A survey of progress and research*, 293–302, London.

STALLIBRASS, S. 2000, Dead dogs, dead horses: site formation processes at Ribchester Roman fort. – V / In: P. Rowley-Conwy (ur. / ed.), *Animal bones, human societies*, 158–165, Oxford.

StatSoft, Inc. 2001, *STATISTICA (Data Analysis Software System), version 6*. – www.statsoft.com

STOKES, P. 2000, A cut above the rest? Officers and man at South Shields Roman fort. – V / In: P. Rowley-Conwy (ur. / ed.), *Animal bones, human societies*, 145–151, Oxford, Oakville.

STORK, M. in / and A. von den DRIESCH 1987, Tierknochenfunde aus Invillino-Ibligo in Friaul/Italien. – V / In: V. Bierbrauer (ur. / ed.), *Invillino-Ibligo in Friaul. Text*, Münchener Beiträge zur Vor- und Frühgeschichte 33, 453–484, München.

SVOLJŠAK, D. 1985, Sv. Pavel nad Vrtovinom. Rezultati sondiranja leta 1966. – *Arheološki vestnik* 36, 195–236.

ŠAŠEL J. 1975, “Rimske ceste v Sloveniji”. – V / In: S. Gabrovec, S. Jesse, P. Petru, J. Šašel, F. Truhlar (ur. / eds.), *Arheološka najdišča Slovenije*, 74–99, Ljubljana.

TEICHERT, M. 1969, Osteometrische Untersuchungen zur Berechnung der Widerristhöhe bei vor- und frühgeschichtlichen Schweinen. – *Ethnographisch-Archäologische Zeitschrift* 10, 517–525.

TOŠKAN, B. in / and J. DIRJEC 2004, Ostanke velikih sesalcev v Viktorjevem spodmolu. (Remains of large mammals in Viktorjev spodmol.) – V / In: I. Turk (ur. / ed.), *Viktorjev spodmol in Mala Triglavca. Prispevki k poznavanju mezolitskega obdobja v Sloveniji / Viktorjev spodmol and Mala Triglavca. Contributions to understanding the Mesolithic period in Slovenia*, Opera Instituti Archaeologici Sloveniae 9, 135–167, Ljubljana.

TOŠKAN, B. in / and J. DIRJEC 2006, Veliki sesalci. (Large mammals.) – V / In: A. Gaspari (ur. / ed.), *Zalog pri Verdu. Tabor kamenodobnih lovcev na zahodnem robu Ljubljanskega barja / Zalog near Verd. Stone Age hunters' camp at the western edge of the Ljubljansko barje*, Opera Instituti Archaeologici Sloveniae 11, 165–188, Ljubljana.

TOŠKAN, B. in / and J. DIRJEC 2008, Ostanke velikih sesalcev z zgodnjerednjeveške Pristave. (Large mammal remains from Early Mediaeval Pristava.) – V / In: A. Pleterski, *Zgodnjerednjevska naselbina na Blejski Pristavi. Najdbe / Frühmittelalterliche Siedlung Pristava in Bled. Funde*, Opera Instituti Archaeologici Sloveniae 14, 139–151, Ljubljana.

TURK, I. 2000, Favna. – V / In: S. Ciglencečki, *Tinje nad Loko pri Žusmu. Poznoantična in zgodnjerednjevska naselbina / Tinje oberhalb von Loka pri Žusmu. Spätantike und frühmittelalterliche Siedlung*, Opera Instituti Archaeologici Sloveniae 4, 167–171, Ljubljana.

VITT, V.O. 1952, Loshadi Pezryryksich kuganov. – *Sovetskaja Archeologija* 16, 163–205.

WILKENS, B. 1990, I resti faunistici. – V / In: G. Sena Chiesa, B. Wilkens, I resti faunistici di Calvatone (CR), *Archeologia Medievale* 17, 307–322.

ZUPANČIČ, M. in / and T. WRABER 1989, Fitocenologija. – V / In: M. Javornik (ur. / ed.), *Enciklopedija Slovenije*. 3. zvezek: Eg – Hab, 118–120, Ljubljana.

## 8.9 PRILOGI / APPENDICES

## PRILOGA / APPENDIX 8.1

Tab. A: Dimenzije izmerjenih ostankov domačega goveda (*Bos taurus*) s Tonovcovega gradu, datiranih v prvo poznoantično fazo (zapisano običajno), drugo poznoantično fazo (zapisano s krepkimi črkami) oz. zgodnjemedijeveško fazo (zapisano poševno). Mere so izražene v mm. Okrajšave: OnB – obseg na bazi; za ostale okrajšave glej von den Driesch 1976.

Tab. A: Dimensions of the measured cattle remains (*Bos taurus*) from Tonovcov grad, dated into Late Antiquity phase 1 (written normally), Late Antiquity phase 2 (written in bold letters) and Early Medieval phase (written in italics). Measurements are given in mm. Abbreviations: OnB – basal circumference; for other abbreviations see von den Driesch 1976.

<i>B. taurus</i>	Dimenzija Dimension	Meritve Measures											
		Proc. corn.	OnB	121,0	134,0								
Mandibula	M7		140,5										
	M8		86,0										
	M9		55,5										
	M15a		68,5										
	M15b		43,0										
	M <sub>3</sub> L		38,0										
	M <sub>3</sub> B		14,0										
Dens (M <sub>3</sub> )	L		34,0	34,5	35,0	37,0	38,0	39,0	35,0	36,0	31,0	36,0	<b>33,0</b>
	B		14,0	14,0	13,0	13,5	16,0	16,5	15,0	14,0	15,0	15,0	<b>12,5</b>
	L		<b>33,0</b>	<b>36,0</b>	<b>36,5</b>	<b>37,0</b>	<b>34,0</b>	<b>37,0</b>	<b>36,5</b>	<b>38,0</b>	<b>38,5</b>	<b>39,5</b>	<b>35,0</b>
	B		<b>14,0</b>	<b>15,0</b>	<b>15,0</b>	<b>14,0</b>	<b>12,0</b>	<b>14,0</b>	<b>12,5</b>	<b>16,0</b>	<b>16,5</b>	<b>15,0</b>	<b>14,0</b>
	L		<b>36,0</b>	<b>36,5</b>	<b>38,0</b>	<i>40,0</i>							
B		<b>15,0</b>	<b>16,0</b>	<b>13,0</b>	<i>14,0</i>								
Epistropheus	BFcr		90,5	91,0	120,0								
	SBV		47,0	-	-								
Scapula	LG		-	60,5	55,0	<b>58,0</b>	<b>47,0</b>	<b>52,0</b>	<b>54,0</b>	55,5	61,0		
	BG		48,0	54,0	42,0	<b>50,0</b>	<b>41,0</b>	-	<b>48,0</b>	-	-		
	GLP		-	71,0	-	<b>71,0</b>	-	<b>62,5</b>	-	66,0	-		
	SLC		50,5	59,0	-	-	-	-	-	-	-		
Humerus	Bp		-	-	-	88,0	-						
	SD		-	27,0	-	-	<b>36,0</b>	-					
	Bd		77,5	-	74,0	-	<b>84,0</b>	<b>84,0</b>					
	BT		71,0	-	70,0	-	<b>80,5</b>	-					
Radius	Bp		-	70,0	74,0	75,0	76,0	82,0	-	-	-	<b>72,0</b>	<b>74,0</b>
	BFp		-	66,0	68,5	68,0	69,5	72,5	-	-	-	<b>77,0</b>	<b>67,0</b>
	SD		35,5	-	38,0	-	-	-	38,0	<b>31,5</b>	-	-	-
	BFd		-	-	-	-	-	-	-	-	<b>53,0</b>	-	-
	Bd		-	-	-	-	-	-	-	-	-	-	-
	Bp		<b>78,0</b>	<b>83,5</b>	<b>84,0</b>	-	-	<b>79,0</b>	-				
	BFp		<b>70,0</b>	<b>77,5</b>	<b>76,5</b>	-	<b>67,5</b>	<b>74,0</b>	-				
	SD		-	-	-	<b>43,0</b>	-	-	-				
	BFd		-	-	-	-	-	-	<i>56,0</i>				
	Bd		-	-	-	-	-	-	-				
Ulna	BPC		47,0	<b>39,0</b>									
	DPA		67,0	<b>63,0</b>									
	SDO		50,5	-									

<i>B. taurus</i>	Dimenzija Dimension	Meritve Measures										
Mc	Bp	57,0	-	-	-	36,0	49,0	55,0	-	-	53,0	-
	Dp	33,5	-	-	-	-	28,5	32,0	-	-	35,5	-
	SD	30,0	19,0	29,5	-	-	25,0	30,0	21,0	32,0	-	29,0
	DD	20,0	-	23,5	-	-	18,5	21,0	-	-	-	-
	Bd	-	-	-	63,5	-	-	-	-	-	-	-
	Dd	30,5	-	-	32,0	-	-	-	-	-	-	-
	GL	-	-	-	-	-	-	-	-	-	-	-
	Bp	<b>48,5</b>	<b>49,0</b>	<b>56,5</b>	<b>60,0</b>	-	-	-	<b>45,0</b>	-	-	-
	Dp	<b>28,0</b>	<b>28,5</b>	<b>31,0</b>	<b>37,0</b>	-	<b>40,0</b>	-	<b>42,5</b>	-	-	-
	SD	-	-	-	<b>36,0</b>	<b>33,5</b>	-	<b>18,0</b>	-	<b>31,0</b>	-	-
	DD	-	-	-	<b>22,0</b>	<b>21,5</b>	-	-	-	<b>20,0</b>	-	-
	Bd	-	-	-	<b>63,5</b>	<b>61,0</b>	-	-	-	<b>59,5</b>	-	-
	Dd	-	-	-	<b>32,0</b>	-	-	-	-	<b>29,0</b>	-	-
	GL	-	-	-	<b>181,5</b>	-	-	-	-	-	-	-
Pelvis	LA	<b>63,0</b>	<b>63,0</b>	<b>68,0</b>	-	-	-	-	-	-	-	-
	LAR	<b>57,0</b>	<b>57,0</b>	<b>62,0</b>	-	-	-	-	-	-	-	-
Sacrum	BFcr	64,0	-	-	-	-	-	-	-	-	-	-
	HFcr	24,0	-	-	-	-	-	-	-	-	-	-
Femur	Bp	-	-	-	-	122,0	-	-	-	-	-	-
	DC	-	39,0	42,5	44,5	44,5	45,5	46,0	46,5	-	-	<b>38,0</b>
	SD	31,5	-	-	-	-	-	-	-	<b>35,0</b>	<b>29,0</b>	-
	Bp	-	-	-	-	-	-	-	-	-	-	-
	DC	<b>43,5</b>	<b>47,0</b>	<b>39,0</b>	<b>39,0</b>	<b>44,0</b>	-	-	-	-	-	-
SD	-	-	-	-	-	-	-	-	-	-	-	
Patella	GB	49,5	56,0	52,0	-	-	-	-	-	-	-	-
Tibia	Bp	-	-	-	-	-	-	-	-	-	-	<b>87,0</b>
	SD	38,5	31,5	-	-	-	-	-	-	-	-	-
	Bd	-	50,5	54,0	55,0	57,5	58,0	60,0	60,0	65,0	-	<b>56,0</b>
	Dd	-	37,5	39,0	-	44,5	43,0	-	44,0	48,0	42,5	<b>42,0</b>
	Bp	-	-	-	-	-	-	-	-	-	-	-
	SD	<b>39,5</b>	-	-	-	-	-	-	-	-	-	-
	Bd	-	<b>57,0</b>	<b>56,0</b>	<b>55,0</b>	<b>57,0</b>	-	-	-	-	-	-
Dd	-	41,5	-	-	40,0	-	-	-	-	-	-	
Mt	Bp	50,0	43,5	46,0	46,5	44,0	-	-	-	-	44,0	46,0
	Dp	45,5	42,5	45,5	-	39,5	-	-	-	-	-	-
	SD	31,0	25,0	27,5	23,5	26,0	27,0	-	-	36,0	26,0	-
	DD	26,0	25,5	24,0	24,5	24,0	-	25,0	21,5	23,0	-	-
	Bd	-	49,0	54,5	-	51,0	-	51,5	-	51,5	-	-
	Dd	-	30,0	31,0	-	28,5	-	31,0	30,0	26,5	-	-
	GL	-	-	-	-	212,5	-	-	-	-	-	-
	Bp	47,5	48,0	-	-	-	-	<b>41,5</b>	<b>42,0</b>	<b>45,0</b>	<b>47,0</b>	<b>50,5</b>
	Dp	46,5	-	-	-	-	-	<b>40,5</b>	<b>41,0</b>	-	<b>43,0</b>	<b>48,0</b>
	SD	29,0	29,5	25,0	<b>25,0</b>	<b>25,5</b>	-	-	-	<b>24,0</b>	-	-
	DD	-	-	-	-	-	-	-	-	-	-	-
	Bd	-	-	-	-	-	<b>54,5</b>	-	-	-	-	-
	Dd	-	-	-	-	-	<b>24,0</b>	-	-	-	-	-
	GL	-	-	-	-	-	<b>31,0</b>	-	-	-	-	-
	Bp	-	-	-	-	-	-	-	-	-	-	-
	Dp	-	-	-	-	-	-	-	-	-	-	-
	SD	22,0	-	-	-	-	-	-	-	-	-	-
	DD	-	24,5	-	-	-	-	-	-	-	-	-
	Bd	-	51,0	53,0	-	-	-	-	-	-	-	-
Dd	-	31,0	29,5	-	-	-	-	-	-	-	-	
GL	-	-	-	-	-	-	-	-	-	-	-	



<i>B. taurus</i>	Dimenzija Dimension	Meritve Measures										
Calcaneus	GL	137,0	131,0	<b>130,0</b>								
	GB	40,5	40,0	<b>42,5</b>								
Astragalus	GLl	58,0	60,0	61,0	61,0	62,0	62,5	62,5	-	64,0	64,5	68,0
	GLm	-	56,0	56,5	56,5	58,0	56,5	58,0	-	-	-	63,0
	DI	-	33,0	33,0	35,0	35,0	35,0	35,0	-	36,0	36,0	39,0
	Dm	-	32,0	-	-	33,0	36,0	33,0	-	-	36,0	36,0
	Bd	-	39,0	38,0	37,5	39,0	41,0	43,0	36,0	-	-	43,0
	GLl	69,5	-	-	-	-	<b>58,0</b>	<b>58,5</b>	<b>62,0</b>	-	<b>68,0</b>	-
	GLm	-	49,0	62,5	57,0	-	<b>54,0</b>	<b>32,0</b>	<b>58,0</b>	-	<b>64,0</b>	47,5
	DI	-	-	37,0	-	-	<b>32,5</b>	-	<b>34,5</b>	-	<b>34,0</b>	29,5
	Dm	-	-	35,0	-	-	<b>32,0</b>	-	<b>33,0</b>	-	<b>35,0</b>	28,0
Bd	-	31,0	-	39,0	<b>44,5</b>	<b>37,5</b>	<b>35,5</b>	<b>39,5</b>	<b>42,0</b>	<b>41,0</b>	31,5	
Centrotarsale	GB	51,0	56,0	56,0	58,0	61,0	<b>52,0</b>	<b>57,5</b>	<b>54,5</b>			
Phalanx 1	Bp	-	-	-	24,0	24,5	25,0	25,0	28,0	29,0	30,0	31,0
	SD	-	-	-	20,5	20,5	22,0	22,5	-	25,5	-	-
	DD	-	-	-	17,0	15,0	14,5	16,0	-	18,0	-	-
	Bd	28,0	31,0	31,5	22,0	23,5	23,0	25,5	-	26,0	-	-
	GL	-	-	-	51,5	47,0	55,0	58,0	-	55,5	-	-
	Bp	31,5	33,0	-	-	-	-	<b>25,0</b>	<b>30,5</b>	<b>31,0</b>	<b>31,5</b>	<b>35,5</b>
	SD	24,5	-	<b>24,5</b>	-	-	-	<b>22,0</b>	-	<b>28,0</b>	<b>29,0</b>	<b>29,5</b>
	DD	18,0	-	<b>18,0</b>	-	-	-	<b>18,0</b>	-	<b>21,0</b>	<b>21,0</b>	<b>21,0</b>
	Bd	29,0	-	<b>27,0</b>	<b>28,0</b>	<b>29,0</b>	<b>35,0</b>	<b>23,0</b>	-	<b>29,0</b>	<b>31,0</b>	<b>31,5</b>
	GL	56,0	-	-	-	-	<b>59,0</b>	<b>56,0</b>	-	<b>55,5</b>	-	<b>59,5</b>
	Bp	-	-	-	26,5	29,0	29,5	32,0	-	-	-	-
	SD	25,0	26,0	-	22,5	24,0	27,5	27,0	-	-	-	26,0
	DD	20,0	21,5	-	16,5	18,5	-	18,5	-	-	-	18,5
	Bd	30,0	31,5	36,0	22,5	26,5	29,0	31,0	-	24,5	23,0	30,0
	GL	56,5	-	-	56,0	56,0	53,0	58,0	58,0	-	-	58,0
	Bp	28,0	32,0									
	SD	-	-									
	DD	-	-									
Bd	25,5	29,0										
GL	36,0	38,0										
Phalanx 2	Bp	-	24,0	25,0	25,5	26,5	27,0	28,5	28,5	30,5	31,0	31,5
	Bd	27,0	20,5	20,0	21,0	-	22,5	24,5	23,0	25,0	23,5	29,5
	GL	44,0	33,0	35,5	36,0	-	37,5	39,0	43,0	40,5	42,0	35,0
	Bp	-	23,5	25,0	25,5	26,0	26,0	26,5	27,0	28,5	32,5	33,5
	Bd	-	-	22,0	19,0	21,0	24,5	-	23,0	25,0	26,5	27,0
	GL	43,0	30,5	32,5	35,0	36,0	40,0	35,0	39,0	36,0	41,0	39,0
	Bp	28,5	30,0	30,5	33,0							
Bd	24,0	25,0	25,5	28,0								
GL	26,0	37,0	39,0	39,0								
Phalanx 3	Ld	41,5	44,0	47,5	52,0	53,0	54,0	-	-	-	-	-
	MBS	15,5	15,5	20,0	25,5	22,5	24,0	17,0	18,0	19,0	22,0	23,0
	DLS	52,5	54,0	54,5	-	66,0	-	-	-	-	-	-
	Ld	-	32,0	46,0	54,0	55,0	60,5	-	45,5			
	MBS	23,0	15,0	16,5	24,0	23,5	24,5	23,5	18,5			
DLS	-	-	54,0	74,0	75,0	78,0	67,0	60,5				

Tab. B: Dimenzije izmerjenih specifično nedeterminiranih ostankov drobnice (Caprinae) s Tonovcovega gradu, datiranih v prvo poznoantično fazo (običajno zapisane številke), drugo poznoantično fazo (krepko zapisane številke) oz. zgodnjemedievalno fazo (poševno zapisane številke). Mere so izražene v mm. Okrajšave: glej von den Driesch 1976.

Tab. B: Dimensions of the measured specifically undetermined remains of sheep/goats (Caprinae) from Tonovcov grad, dated into Late Antiquity phase 1 (written normally), Late Antiquity phase 2 (written in bold letters) and Early Medieval phase (written in italics). Measurements are given in mm. Abbreviations: see von den Driesch 1976.

Caprinae	Dimenzija Dimension	Meritve Measures										
Mandibula	M8	<b>51,0</b>										
Dens (M <sub>3</sub> )	L	22,5	21,5	21,5	21,0	21,0	21,0	21,0	21,5	21,5	22,0	22,0
	B	8,1	8,0	8,0	7,9	8,0	8,1	8,5	8,2	8,8	8,1	8,6
	L	22,0	22,0	22,5	23,0	23,0	23,5	24,0	24,5	23,5	<b>20,0</b>	<b>20,0</b>
	B	8,0	8,4	8,1	8,8	9,0	8,5	8,7	8,5	8,4	7,5	7,6
	L	<b>21,0</b>	<b>19,0</b>	<b>21,0</b>	<b>21,0</b>	<b>21,0</b>	<b>21,0</b>	<b>21,0</b>	<b>21,0</b>	<b>21,5</b>	<b>21,5</b>	<b>21,5</b>
	B	7,8	7,2	<b>8,3</b>	<b>7,0</b>	<b>8,0</b>	<b>8,0</b>	<b>8,2</b>	<b>8,5</b>	<b>7,9</b>	<b>8,9</b>	<b>8,0</b>
	L	<b>22,0</b>	<b>22,0</b>	<b>22,0</b>	22,5	23,0	22,5	22,5	22,5	22,5	23,0	23,0
	B	<b>8,2</b>	<b>8,3</b>	7,7	7,8	7,7	<b>8,3</b>	<b>8,2</b>	<b>8,4</b>	<b>9,0</b>	<b>8,3</b>	<b>8,4</b>
	L	23,0	23,0	23,0	23,5	24,0	20,0	21,0	21,0	21,5	21,5	21,5
	B	<b>8,6</b>	<b>8,9</b>	<b>9,8</b>	<b>7,9</b>	<b>8,2</b>	<b>8,5</b>	<b>7,9</b>	<b>8,0</b>	<b>7,9</b>	<b>8,6</b>	<b>8,9</b>
L	21,5	22,0	22,0	22,0	23,0	25,0	23,0	22,5				
L	<b>8,0</b>	<b>8,0</b>	<b>8,0</b>	<b>8,4</b>	<b>8,6</b>	<b>9,4</b>	<b>8,1</b>	8,9				
Atlas	BFcr	44,0										
	BFcd	44,0										
Epistropheus	BFcr	43,0										
Scapula	LG	28,0	<b>24,0</b>	<b>26,0</b>	<b>26,0</b>	<b>24,5</b>	<b>25,0</b>	-	28,0			
	GLP	35,0	<b>30,0</b>	-	<b>32,0</b>	-	<b>32,0</b>	-	34,0			
	BG	26,0	<b>20,5</b>	<b>23,0</b>	-	<b>20,5</b>	<b>18,5</b>	-	20,5			
	SLC	22,0	<b>16,5</b>	<b>21,5</b>	<b>20,5</b>	-	-	<b>23,5</b>	-			
Humerus	Bp	-	-	-	-	-	-	<b>46,0</b>	-	-		
	SD	13,0	-	-	<b>14,0</b>	-	-	-	-	-		
	Bd	-	27,0	-	-	<b>30,0</b>	<b>31,0</b>	-	-	-		
	BT	-	26,0	32,0	-	-	<b>31,0</b>	-	<b>31,0</b>	37,0		
Radius	SD	16,0	11,5	<b>14,0</b>	14,5	18,5	15,5	16,0	16,5	17,5	17,0	<b>13,5</b>
		<b>12,0</b>	<b>12,5</b>	<b>14,0</b>	<b>14,5</b>	<b>15,5</b>	<b>16,0</b>	<b>16,5</b>	<b>16,0</b>	<b>17,0</b>	<b>17,5</b>	<b>18,0</b>
		<b>18,5</b>	<b>11,5</b>	<b>17,0</b>	<b>15,5</b>	<b>15,5</b>	<b>16,0</b>	<b>16,0</b>	<b>17,0</b>	<b>18,0</b>	15,5	16,0
		<i>16,0</i>	<i>16,5</i>	<i>17,0</i>	18,5							
Ulna	BPC	16,5										
Metacarpus	Bp	20,0	24,5	-	<b>21,5</b>	<b>22,5</b>	<b>24,0</b>	<b>26,0</b>	-	-	-	
	Dp	14,0	17,0	-	<b>16,0</b>	-	<b>17,0</b>	<b>18,0</b>	-	-	-	
	SD	-	16,0	13,0	-	-	<b>15,5</b>	<b>16,0</b>	<b>14,0</b>	<b>12,0</b>	18,5	
Pelvis	LA	26,0	29,0	<b>27,0</b>								
	LAR	23,0	27,0	<b>24,5</b>								
Femur	DC	-	-	<b>18,5</b>	<b>19,0</b>	<b>19,5</b>	<b>23,0</b>	<b>24,0</b>	<b>21,0</b>	-	-	
	SD	<b>11,5</b>	<b>13,5</b>	-	-	-	-	-	-	10,5	15,0	

Caprinae	Dimenzija Dimension	Meritve Measures											
Tibia	SD	11,0	11,0	12,0	12,0	13,0	13,5	14,5	14,5	14,5	16,0	16,0	
	Bd	-	-	-	-	-	-	-	-	-	-	-	
	Dd	-	-	-	-	-	-	-	-	-	-	-	
	SD	16,0	16,5	9,5	12,0	14,0	12,5	-	-	-	17,0	-	
	Bd	-	-	-	-	-	23,0	24,0	27,0	28,0	29,0	28,0	
	Dd	-	-	-	-	-	17,5	21,0	20,0	14,5	-	20,5	
	SD	11,0	11,0	11,0	11,5	12,5	13,0	13,0	14,0	14,0	14,0	14,0	
	Bd	-	-	-	-	-	-	-	-	-	-	-	
	Dd	-	-	-	-	-	-	-	-	-	-	-	
	SD	14,0	12,0	14,5	15,0	15,5	16,0	16,5	16,5	-	13,0	-	
	Bd	-	-	-	-	-	-	-	-	-	26,0	21,5	24,0
	Dd	-	-	-	-	-	-	-	-	-	22,0	17,0	19,5
	SD	-	-	14,5	-	-	-	-	-	-	10,5	11,5	15,0
	Bd	26,0	26,0	26,5	26,5	26,5	28,0	28,0	27,5	-	-	-	
	Dd	20,0	21,0	19,5	20,5	20,5	21,0	21,5	21,5	-	-	-	
	SD	15,0	15,5	16,0	16,0	16,0	17,0	14,5	-	-	-	12,0	
	Bd	-	-	-	-	-	-	23,5	24,0	25,5	30,0	-	
	Dd	-	-	-	-	-	-	18,0	20,0	19,5	21,0	-	
SD	15,0	-	-	14,5	-	-	-	-	-	-	-		
Bd	-	24,0	25,0	25,0	25,0	-	-	-	-	-	-		
Dd	-	18,5	19,0	19,0	20,5	-	-	-	-	-	-		
Metatarsus	Bp	-	-	-	-	-	-	-	-	-	20,5	21,5	
	Dp	-	-	-	-	-	-	-	-	-	20,5	-	
	SD	10,5	10,5	11,0	12,0	13,0	8,5	10,0	11,0	11,0	11,5	13,0	
	Bp	23,0	-	-	-	-	-	-	-	-	-	-	
	Dp	-	-	-	-	-	-	-	-	-	-	-	
	SD	13,5	10,0	11,5	10,5	12,0	12,5	-	-	-	-	-	
Astragalus	GLl	30,0	28,0	28,0	28,0	35,0	30,0	30,5	31,0	-	-	-	
	GLm	28,0	25,5	-	-	32,5	29,0	28,5	28,5	-	-	-	
	Dl	16,0	15,0	14,0	14,5	18,0	16,0	17,0	17,5	-	-	-	
	Dm	16,0	14,0	-	-	19,5	17,0	16,5	17,0	-	-	-	
	Bd	19,0	17,5	18,0	-	21,5	17,5	21,0	20,0	-	-	-	
Phalanx 1	Bp	11,5	12,5	13,0	13,5	-	-	12,0	12,5	11,5	12,0	-	
	SD	9,5	9,5	31,0	-	-	9,5	9,5	10,0	8,5	11,0	-	
	DD	13,5	8,0	9,0	-	-	7,5	8,0	8,0	7,0	8,0	-	
	Bd	10,5	11,0	12,5	-	12,5	10,5	11,0	11,5	10,5	11,5	-	
	GL	35,5	35,5	39,0	-	-	-	34,0	37,5	33,0	38,0	-	
Phalanx 2	Bp	11,0	13,5	16,0	-	-	-	-	-	-	-	-	
	Bd	8,5	11,5	12,5	-	-	-	-	-	-	-	-	
	GL	22,5	21,0	29,0	-	-	-	-	-	-	-	-	
Phalanx 3	Ld	26,5	-	-	-	-	-	-	-	-	-	-	
	DLS	26,0	-	-	-	-	-	-	-	-	-	-	
	MBS	11,0	-	-	-	-	-	-	-	-	-	-	

Tab. C: Dimenzije izmerjenih ostankov ovce (*O. aries*) s Tonovcovega gradu, datiranih v prvo poznoantično fazo (običajno zapisane številke), drugo poznoantično fazo (krepko zapisane številke) oz. zgodnjerednjeveško fazo (poševno zapisane številke). Mere so izražene v mm. Okrajšave: glej von den Driesch 1976.

Tab. C: Dimensions of the measured sheep remains (*O. aries*) from Tonovcov grad, dated into Late Antiquity phase 1 (written normally), Late Antiquity phase 2 (written in bold letters) and Early Medieval phase (written in italics). Measurements are given in mm. Abbreviations: see von den Driesch 1976.

<i>O. aries</i>	Dimenzija Dimension	Meritve Measures										
Mandibula	M7	<b>67,0</b>	-	-								
	M8	<b>46,5</b>	-	-								
	M9	<b>21,0</b>	22,5	20,0								
	M15b	<b>18,0</b>	<b>21,0</b>	<b>17,0</b>								
	M15c	<b>15,0</b>	<b>20,0</b>	<b>13,5</b>								
Dens (M <sub>3</sub> )	L	<b>24,5</b>	<b>22,0</b>	<b>22,0</b>								
	B	8,6	8,2	8,3								
Atlas	BFcd	<b>46,0</b>										
Epistropheus	BFcr	<b>38,5</b>	<b>43,0</b>	<b>49,0</b>								
	SBV	-	<b>23,5</b>	-								
Scapula	LG	-	-	-	<b>26,0</b>							
	BG	20,5	23,0	<b>18,0</b>	<b>21,5</b>							
	SLC	-	-	<b>17,0</b>	<b>20,0</b>							
Humerus	SD	-	<b>14,5</b>	-	-	-	-	-	-	-	-	-
	Bd	28,0	<b>27,0</b>	<b>28,0</b>	<b>29,0</b>	<b>29,5</b>	<b>30,0</b>	<b>31,0</b>	<b>32,0</b>	<b>32,0</b>	<b>33,0</b>	-
	BT	-	<b>26,5</b>	<b>27,5</b>	<b>28,5</b>	<b>28,0</b>	<b>29,0</b>	<b>31,0</b>	<b>30,0</b>	-	<b>31,0</b>	<b>28,0</b>
	SD	-	-	-	-	-	-					
	Bd	-	<b>31,0</b>	<b>26,0</b>	<b>31,0</b>	<i>30,5</i>	<i>31,0</i>					
BT	<b>30,0</b>	<b>30,0</b>	-	<b>30,5</b>	<i>30,0</i>	<i>30,0</i>						
Radius	Bp	28,0	30,5	-	-	-	-	-	-	-	<b>29,5</b>	<b>30,0</b>
	BFp	27,0	28,0	-	-	-	-	-	-	<b>25,0</b>	<b>28,5</b>	<b>28,0</b>
	SD	-	18,5	<b>15,0</b>	-	-	-	-	-	-	-	-
	Bd	-	-	-	-	<b>25,0</b>	<b>27,5</b>	<b>30,5</b>	-	-	-	-
	BFd	-	-	-	<b>24,0</b>	<b>23,0</b>	-	<b>26,5</b>	<b>24,0</b>	-	-	-
	Bp	<b>30,0</b>	<b>30,0</b>	<b>30,0</b>	<b>30,5</b>	<b>31,0</b>	<b>31,0</b>	<b>32,5</b>	-	<b>27,0</b>	<b>29,5</b>	<b>30,0</b>
	BFp	<b>26,5</b>	<b>27,5</b>	<b>28,0</b>	<b>28,0</b>	<b>28,0</b>	<b>29,0</b>	<b>29,5</b>	-	<b>25,0</b>	<b>26,0</b>	<b>26,5</b>
	SD	-	-	-	-	-	<b>16,5</b>	<b>16,5</b>	-	-	-	-
	Bd	-	-	-	-	-	-	-	<b>27,0</b>	-	-	-
	BFd	-	-	-	-	-	-	-	<b>22,0</b>	-	-	-
	Bp	<b>31,0</b>	<b>33,5</b>	-	<i>31,0</i>	<i>31,0</i>						
	BFp	<b>28,0</b>	<b>30,5</b>	-	<i>29,0</i>	<i>29,0</i>						
	SD	-	-	-	-	-						
	Bd	-	-	<i>30,0</i>	-	-						
	BFd	-	-	<i>27,0</i>	-	-						
Ulna	BPC	-	<b>17,0</b>	<b>18,5</b>	<i>16,5</i>							
	DPA	27,0	-	<b>26,0</b>	-							
	SDO	24,0	-	<b>24,5</b>	-							
Mc	Bp	24,0	-	-	22,0	<b>19,0</b>	<b>24,0</b>	<b>26,0</b>	-	<b>24,0</b>	-	<i>21,5</i>
	Dp	18,5	-	-	16,0	<b>18,0</b>	<b>18,0</b>	<b>17,5</b>	-	<b>16,5</b>	-	<i>16,0</i>
	SD	14,5	-	-	-	-	<b>14,5</b>	<b>14,5</b>	<b>15,5</b>	-	-	<i>13,0</i>
	DD	13,0	11,0	-	-	-	-	-	<b>11,0</b>	-	-	-
	Bd	-	25,5	30,5	-	-	-	-	<b>26,0</b>	-	<i>24,5</i>	-
	Dd	-	15,0	17,0	-	-	-	-	<b>17,5</b>	-	<i>16,0</i>	-
	GL	131,5	-	-	-	-	-	-	-	-	-	-
Femur	Bp	-	-	-	-	-	47,0	-	-			
	DC	-	-	-	-	-	<b>21,5</b>	<b>20,0</b>	-			
	Bd	32,0	33,5	36,0	38,0	37,0	-	-	36,5			

<i>O. aries</i>	Dimenzija Dimension	Meritve Measures										
Tibia	Bp	<b>42,5</b>										
	Dp	<b>37,5</b>										
Mt	Bp	17,0	19,0	19,0	-	<b>19,0</b>	<b>21,0</b>	<b>22,5</b>	<b>18,0</b>			
	Dp	16,5	19,5	19,0	-	<b>19,5</b>	<b>19,0</b>	<b>22,0</b>	<b>18,0</b>			
	SD	10,0	12,0	12,0	10,5	-	<b>13,5</b>	-	<b>10,5</b>			
	DD	-	-	-	-	-	-	-	-			
	Bd	-	-	-	-	-	-	-	-			
	Dd	-	-	-	-	-	-	-	-			
	GL	-	-	-	-	-	-	-	-			
Calcaneus	GL	54,0	<b>57,0</b>	-	53,5							
	GB	17,5	<b>19,0</b>	17,0	18,5							
Astragalus	GLl	29,0	30,5	-	<b>27,0</b>	<b>27,0</b>	<b>27,5</b>	<b>29,5</b>	<b>30,5</b>	<b>27,5</b>	<b>29,0</b>	<b>28,5</b>
	GLm	27,5	29,0	25,0	<b>25,5</b>	<b>26,0</b>	<b>24,5</b>	<b>27,5</b>	<b>27,5</b>	<b>25,5</b>	<b>25,5</b>	<b>26,5</b>
	DI	16,0	17,0	15,0	<b>15,0</b>	<b>15,5</b>	-	<b>16,5</b>	<b>10,5</b>	-	<b>16,0</b>	<b>15,0</b>
	Dm	16,5	18,0	24,0	<b>14,5</b>	<b>16,0</b>	<b>13,0</b>	<b>16,0</b>	<b>16,5</b>	<b>15,5</b>	<b>16,0</b>	<b>16,0</b>
	Bd	19,0	19,5	18,0	<b>16,5</b>	<b>18,0</b>	<b>15,5</b>	<b>19,0</b>	<b>18,0</b>	<b>16,0</b>	<b>19,0</b>	<b>18,0</b>
Centrotarsale	GB	22,0										
Phalanx 1	Bp	11,0	<b>11,0</b>	<b>12,0</b>	<b>12,0</b>	<b>12,0</b>	<b>13,0</b>	<b>13,0</b>	<b>13,5</b>	10,0	11,5	11,5
	SD	9,0	<b>9,0</b>	<b>9,5</b>	<b>10,0</b>	<b>9,5</b>	<b>10,5</b>	<b>11,0</b>	<b>10,5</b>	8,5	10,5	8,5
	DD	7,5	<b>7,0</b>	<b>7,5</b>	<b>8,0</b>	<b>8,0</b>	<b>8,0</b>	<b>8,5</b>	<b>8,5</b>	7,0	8,5	7,0
	Bd	9,5	<b>10,0</b>	<b>10,0</b>	<b>11,0</b>	-	<b>12,0</b>	<b>12,0</b>	<b>12,5</b>	9,5	10,0	10,0
	GL	34,0	<b>35,5</b>	<b>33,0</b>	<b>31,0</b>	<b>36,5</b>	<b>34,0</b>	<b>36,0</b>	<b>38,0</b>	30,5	33,5	34,0
	Bp	12,0	13,0									
	SD	9,0	11,0									
	DD	7,5	9,0									
	Bd	11,0	12,5									
	GL	32,5	36,5									
Phalanx 2	Bp	11,0										
	Bd	9,5										
	GL	21,0										
Phalanx 3	MBS	<b>5,0</b>										

Tab. D: Dimenzije izmerjenih ostankov kože (*C. hircus*) s Tonovcovega gradu, datiranih v prvo poznoantično fazo (običajno zapisane številke), drugo poznoantično fazo (krepko zapisane številke) oz. zgodnjemedievalno fazo (poševno zapisane številke). Mere so izražene v mm. Okrajšave: OnB – obseg na bazi; za ostale okrajšave glej von den Driesch 1976.

Tab. D: Dimensions of the measured goat remains (*C. hircus*) from Tonovcov grad, dated into Late Antiquity phase 1 (written normally), Late Antiquity phase 2 (written in bold letters) and Early Medieval phase (written in italics). Measurements are given in mm. Abbreviations: OnB – basal circumference; for other abbreviations see von den Driesch 1976.

<i>C. hircus</i>	Dimenzija Dimension	Meritve Measures										
Proc. corn.	L (anter.)	158,0	-									
	L (post.)	135,0	-									
	OnB	78,0	96,0									
Mandibula	M9	<b>25,5</b>	<b>27,5</b>	<b>26,0</b>	-	<b>25,0</b>	<b>25,5</b>					
	M15a	-	-	-	-	-	<b>20,0</b>					
	M15b	<b>23,5</b>	<b>20,0</b>	-	-	-	-					
	M15c	<b>17,0</b>	<b>13,0</b>	<b>14,5</b>	<b>16,0</b>	<b>16,0</b>	<b>15,5</b>					
Epistropheus	BFcr	44,0										
Scapula	LG	<b>25,5</b>	27,5									
	BG	<b>22,5</b>	<b>23,5</b>									
	GLP	<b>33,0</b>	<b>33,0</b>									
	SLC	<b>21,0</b>	-									
Humerus	Bd	27,0	32,0	<b>28,5</b>	<b>33,0</b>	-	<i>31,0</i>					
	BT	26,0	31,0	<b>27,0</b>	<b>32,0</b>	<b>33,0</b>	<i>29,0</i>					
Radius	Bp	32,0	<b>28,0</b>	<b>31,0</b>	<b>32,0</b>	<i>30,5</i>	<i>31,5</i>					
	BFp	31,0	<b>27,0</b>	<b>29,0</b>	<b>31,0</b>	<i>29,0</i>	-					
Mc	Bp	-	<b>22,0</b>	-	<b>23,0</b>	<i>24,5</i>	-					
	Dp	-	<b>16,5</b>	-	<b>17,5</b>	<i>18,0</i>	-					
	SD	14,5	-	-	<b>13,5</b>	<i>16,0</i>	-					
	DD	9,5	-	<b>10,0</b>	-	-	<i>10,0</i>					
	Bd	24,0	-	<b>27,0</b>	-	-	<i>24,5</i>					
	Dd	15,5	-	-	-	-	<i>15,5</i>					
Femur	DC	<b>20,5</b>	21,5									
Mt	Bp	-	23,5	21,0	-	<b>19,5</b>	-	<i>19,5</i>				
	Dp	-	23,0	20,0	-	-	-	<i>18,0</i>				
	SD	-	-	-	-	<b>12,0</b>	-	-				
	DD	11,0	-	-	-	-	-	-				
	Bd	27,0	-	-	<b>14,0</b>	-	<i>26,0</i>	-				
	Dd	18,0	-	-	-	-	<i>16,0</i>	-				
Astragalus	GLl	28,0	28,5	32,0	-	<b>29,0</b>	<b>30,0</b>	<b>31,0</b>	<b>27,0</b>	<b>32,0</b>	<i>28,0</i>	
	GLm	27,0	26,0	30,0	26,5	<b>26,5</b>	<b>28,0</b>	<b>28,5</b>	<b>26,0</b>	<b>30,5</b>	<i>26,5</i>	
	Dl	16,5	16,0	27,5	-	<b>15,0</b>	<b>15,5</b>	<b>16,0</b>	<b>14,0</b>	<b>16,5</b>	<i>14,5</i>	
	Dm	17,0	16,0	28,0	17,0	<b>15,0</b>	<b>16,0</b>	<b>17,0</b>	<b>15,0</b>	<b>17,0</b>	<i>14,5</i>	
	Bd	19,0	18,0	20,5	18,5	-	<b>19,0</b>	<b>19,5</b>	<b>16,5</b>	<b>21,0</b>	<i>18,0</i>	
Centrotars.	GB	<b>22,5</b>	23,5									
Phalanx 1	Bp	14,0	<b>12,5</b>	<b>12,0</b>	<b>12,0</b>	<b>12,5</b>	<b>13,0</b>	<b>13,0</b>	<b>14,0</b>	<i>14,0</i>		
	SD	11,5	<b>10,0</b>	<b>9,5</b>	<b>10,0</b>	<b>10,5</b>	<b>9,5</b>	<b>11,5</b>	-	<i>12,0</i>		
	DD	9,0	<b>8,0</b>	<b>8,5</b>	<b>7,5</b>	<b>7,1</b>	<b>7,5</b>	<b>9,5</b>	-	<i>9,5</i>		
	Bd	12,5	-	<b>11,5</b>	<b>10,5</b>	<b>11,5</b>	<b>11,5</b>	<b>14,0</b>	<b>10,0</b>	<i>14,5</i>		
	GL	42,5	-	<b>34,0</b>	<b>36,5</b>	<b>39,5</b>	<b>35,0</b>	<b>37,0</b>	<b>26,0</b>	<i>40,0</i>		
Phalanx 2	Bp	<b>11,0</b>	<b>15,5</b>									
	Bd	<b>9,0</b>	<b>12,0</b>									
	GL	<b>24,5</b>	<b>28,0</b>									
Phalanx 3	Ld	<b>19,0</b>	-									
	DLS	<b>25,0</b>	<b>32,5</b>									
	MBS	<b>4,0</b>	<b>5,5</b>									

Tab. E: Dimenzije izmerjenih ostankov prašiča (*Sus* sp.) s Tonovcovega gradu, datiranih v prvo poznoantično fazo (običajno zapisane številke), drugo poznoantično fazo (krepko zapisane številke) oz. zgodnj srednjeveško fazo (poševno zapisane številke). Mere so izražene v mm. Okrajšave: glej von den Driesch 1976.

Tab. E: Dimensions of the measured pig/wild boar remains (*Sus* sp.) from Tonovcov grad, dated into Late Antiquity phase 1 (written normally), Late Antiquity phase 2 (written in bold letters) and Early Medieval phase (written in italics). Measurements are given in mm. Abbreviations: see von den Driesch 1976.

<i>Sus</i> sp.	Dimenzija Dimension	Meritve Measures										
Maxilla	M28	<b>60,0</b>	<b>54,5</b>									
Mandibula	M8	69,0										
	M9a	<b>35,5</b>										
Dens (M <sup>3</sup> )	L	-	31,5	31,5	31,0	27,5	<b>27,5</b>	<b>27,5</b>	<b>28,5</b>	<b>25,0</b>	<b>26,0</b>	<b>31,5</b>
	B	13,5	18,0	17,5	19,0	15,0	<b>17,0</b>	<b>17,0</b>	<b>18,5</b>	<b>16,5</b>	<b>17,0</b>	<b>18,0</b>
	L	<b>32,0</b>	<i>27,0</i>									
	B	<b>27,5</b>	<i>16,0</i>									
Dens (M <sub>3</sub> )	L	-	34,5	32,0	-	29,0	<b>33,0</b>	-	<b>27,0</b>	-	<b>25,0</b>	-
	B	15,0	15,5	15,5	14,5	13,0	<b>14,5</b>	<b>14,0</b>	<b>13,0</b>	<b>13,0</b>	<b>16,5</b>	<b>14,5</b>
	L	-	<b>31,5</b>	<b>32,0</b>	-							
	B	<b>15,0</b>	<b>15,0</b>	<b>15,0</b>	<i>18,5</i>							
Atlas	BFcr	78,0										
Epistropheus	BFcr	<b>45,0</b>	46,0									
Scapula	LG	-	26,0	-	-	-	<b>26,0</b>	<b>26,0</b>	-	<b>24,5</b>	<b>25,0</b>	<b>25,5</b>
	BG	25,5	22,5	-	-	-	<b>19,5</b>	-	-	<b>18,5</b>	<b>22,5</b>	-
	GLP	-	31,0	-	-	-	<b>30,5</b>	<b>31,0</b>	<b>33,0</b>	<b>29,0</b>	-	-
	SLC	24,5	20,5	19,5	21,0	23,5	<b>23,5</b>	-	-	<b>18,5</b>	-	-
	LG	<b>25,5</b>	<b>26,5</b>	<b>27,0</b>	<b>29,0</b>	<b>30,0</b>	<b>31,5</b>	<b>29,5</b>	<b>27,5</b>	<b>27,0</b>	-	<b>25,5</b>
	BG	-	<b>23,5</b>	-	<b>23,0</b>	<b>25,0</b>	<b>27,0</b>	-	-	-	<b>22,0</b>	<b>22,5</b>
	GLP	<b>31,0</b>	-	<b>34,0</b>	<b>32,5</b>	<b>36,0</b>	<b>37,0</b>	<b>36,0</b>	<b>32,0</b>	-	-	-
	SLC	<b>21,0</b>	-	<b>21,5</b>	<b>23,0</b>	-	<b>22,5</b>	<b>24,0</b>	<b>21,0</b>	<b>22,0</b>	<b>21,0</b>	-
	LG	<b>27,0</b>	-	-	<i>22,0</i>	<i>30,5</i>	-					
	BG	<b>23,0</b>	-	-	<i>17,5</i>	<i>21,5</i>	-					
GLP	<b>32,0</b>	-	-	<i>25,5</i>	-	-						
SLC	-	<b>21,5</b>	<b>19,5</b>	<i>16,0</i>	<i>18,5</i>	<i>22,5</i>						
Humerus	SD	11,5	13,0	16,5	17,5	-	-	16,5	<b>14,5</b>	<b>15,5</b>	<b>17,0</b>	<b>12,5</b>
	Bd	-	-	-	-	35,5	35,5	39,0	-	-	-	<b>34,0</b>
	BT	-	-	-	-	30,0	30,0	36,0	-	-	-	<b>30,0</b>
	SD	-	-	-	-	-	-	-	13,0	-	-	-
	Bd	<b>35,5</b>	<b>36,0</b>	<b>38,0</b>	<b>33,0</b>	-	<b>35,0</b>	-	-	<b>34,0</b>	-	<b>36,0</b>
	BT	<b>30,5</b>	<b>32,0</b>	<b>32,0</b>	<b>27,0</b>	<b>28,5</b>	<b>28,5</b>	<b>31,0</b>	-	<b>29,5</b>	<b>31,5</b>	<b>30,5</b>
	SD	<i>11,5</i>										
	Bd	-										
BT	-											
Ulna	BPC	14,0	16,0	20,0	<b>17,0</b>	<b>17,0</b>	<b>20,0</b>	<b>20,0</b>	<b>20,5</b>	<b>21,0</b>	<b>17,5</b>	<b>17,0</b>
	DPA	-	-	33,0	-	-	-	<b>32,0</b>	-	-		
Radius	Bp	-	26,0	27,5	29,0	-	<b>28,0</b>	-	<b>25,5</b>	<b>26,0</b>	<b>27,0</b>	<b>28,0</b>
	BFp	26,0	-	-	-	-	-	-	-	-	-	-
	SD	-	17,0	-	-	14,5	-	<b>17,0</b>	-	-	-	-
	Bd	28,5	-	-	-	-	-	-	-	-	-	-
	Bp	<b>24,0</b>	<b>28,0</b>	-	22,5	25,5						
	BFp	-	-	-	-	-						
	SD	-	-	<i>13,0</i>	-	-						
Bd												
Mc 3	Bp	14,5	<b>16,0</b>	<b>15,0</b>								
Mc 4	Bp	12,5	<b>14,5</b>									

<i>Sus</i> sp.	Dimenzija Dimension	Meritve Measures										
Mc 5	Bd	<b>10,0</b>	<b>10,0</b>									
	GL	<b>61,0</b>	<b>53,0</b>									
Pelvis	LA	30,5	<b>28,0</b>	-	<b>33,0</b>							
	LAR	28,5	<b>25,5</b>	<b>29,0</b>	<b>30,5</b>							
Femur	Bp	-	-	57,0	-	-	-	-				
	DC	-	-	24,0	-	-	-	-				
	SD	18,5	18,5	-	<b>18,0</b>	15,5	17,0	19,0				
Patella	GB	18,0	<b>17,5</b>									
Tibia	SD	16,5	-	-	-	-	-	<b>18,0</b>	<b>18,5</b>	-	-	-
	Bd	-	27,0	25,0	27,0	27,5	32,0	-	-	<b>26,5</b>	<b>27,0</b>	<b>28,0</b>
	Dd	-	22,0	23,5	24,0	21,5	27,5	-	-	<b>24,5</b>	<b>24,0</b>	<b>24,0</b>
	SD	-	-	<b>14,0</b>	-	-	-	-	18,0			
	Bd	<b>29,0</b>	<b>31,5</b>	-	<b>31,0</b>	<b>27,0</b>	<b>28,0</b>	<b>26,5</b>	-			
	Dd	<b>25,5</b>	<b>23,5</b>	-	<b>18,0</b>	<b>22,5</b>	<b>23,0</b>	<b>24,0</b>	-			
Calcaneus	GL	-	-									
	GB	18,0	<b>20,5</b>									
Astragalus	GLl	36,0	<b>34,0</b>	<b>38,5</b>	<b>41,5</b>	<b>31,5</b>	37,0	39,0	41,0	39,0		
	GLm	34,5	<b>32,0</b>	-	<b>37,0</b>	<b>27,5</b>	-	<b>35,5</b>	<b>38,0</b>	<b>36,5</b>		
	DI	19,0	-	-	22,5	16,0	-	19,5	21,0	20,0		
	Bd	22,0	<b>18,5</b>	-	<b>25,0</b>	<b>18,0</b>	-	<b>22,0</b>	<b>24,0</b>	<b>21,0</b>		
Mt 2	Bp	13,5	4,0									
	GL	-	<b>57,0</b>									
Mt 3	Bp	<b>12,0</b>	14,0	15,0								
Mt 4	Bp	15,0	<b>13,5</b>									
Mt 5	Bp	4,5	5,0									
Phalanx 1	Bp	13,0	<b>17,5</b>	<b>13,5</b>	<b>14,5</b>	<b>15,5</b>	<b>15,5</b>	<b>14,5</b>	<b>15,0</b>			
	SD	11,5	<b>13,5</b>	<b>11,0</b>	<b>12,5</b>	<b>12,0</b>	12,5	12,5	11,5			
	DD	8,0	<b>9,5</b>	<b>8,5</b>	<b>8,0</b>	<b>9,0</b>	<b>9,5</b>	<b>9,0</b>	<b>9,0</b>			
	Bd	12,5	<b>16,0</b>	<b>12,0</b>	<b>14,0</b>	<b>14,0</b>	15,0	14,5	14,5			
	GL	31,0	<b>39,0</b>	<b>34,0</b>	<b>34,0</b>	<b>33,5</b>	<b>31,5</b>	<b>33,0</b>	<b>33,0</b>			
Phalanx 2	Bp	14,0	14,0	<b>13,0</b>	<b>13,5</b>	<b>14,0</b>	<b>14,5</b>	<b>16,5</b>	16,0	14,0		
	Bd	12,0	12,0	<b>11,5</b>	<b>11,5</b>	<b>13,0</b>	<b>12,0</b>	<b>14,0</b>	13,0	13,0		
	GL	23,0	26,5	<b>18,0</b>	<b>21,0</b>	<b>22,0</b>	<b>21,5</b>	<b>21,5</b>	21,5	19,5		
Phalanx 3	Ld	<b>21,5</b>	<b>25,5</b>	27,5								
	DLS	<b>21,0</b>	<b>25,5</b>	27,5								
	MBS	<b>9,5</b>	<b>10,0</b>	11,0								



Tab. F: Dimenzije izmerjenih ostankov konja (*E. caballus*) s Tonovcovega gradu, datiranih v prvo poznoantično fazo (običajno zapisane številke), drugo poznoantično fazo (krepko zapisane številke) oz. zgodnjemedievalno fazo (poševno zapisane številke). Mere so izražene v mm. Okrajšave: glej von den Driesch 1976.

Tab. F: Dimensions of the measured horse remains (*E. caballus*) from Tonovcov grad, dated into Late Antiquity phase 1 (written normally), Late Antiquity phase 2 (written in bold letters) and Early Medieval phase (written in italics). Measurements are given in mm. Abbreviations: see von den Driesch 1976.

<i>E. caballus</i>	Dimenzija Dimension	Meritve Measures			
Humerus	Bd	<b>78,0</b>	-		
	BT	<b>75,0</b>	<b>73,0</b>		
Radius	Bp	-	-	<b>78,0</b>	<b>78,5</b>
	BFp	-	-	<b>73,0</b>	<b>72,5</b>
	SD	-	<b>37,0</b>	-	-
	Bd	<b>68,0</b>	<b>71,0</b>	-	-
	BFd	<b>58,5</b>	<b>59,0</b>	-	-
Mc	Bp	<b>50,0</b>			
	Dp	<b>32,0</b>			
	SD	<b>32,5</b>			
	DD	<b>22,5</b>			
	GLI	217,0			
	LI	<b>209,0</b>			
Femur	DC	45,5			
	SD	40,0			
Tibia	Bd	<b>67,5</b>	<b>71,5</b>		
	Dd	<b>45,0</b>	<b>43,0</b>		
Calcaneus	GB	<b>51,0</b>			
Astragalus	GH	60,0	-	<b>56,5</b>	
	GB	-	-	<b>63,5</b>	
	BFd	-	-	<b>53,5</b>	
	LmT	59,0	51,5	<b>57,0</b>	
Mt	Bp	<b>45,5</b>			
	Dp	<b>36,5</b>			
	SD	<b>30,5</b>			
	DD	23,5			
	Bd	<b>46,5</b>			
	Dd	<b>34,5</b>			
	GLI	<b>253,0</b>			
	LI	<b>252,0</b>			
GL	<b>257,0</b>				

<i>E. caballus</i>	Dimenzija Dimension	Meritve Measures			
Phalanx 1	Bp	-	52,0	52,5	
	BFp	-	<b>48,5</b>	<b>47,5</b>	
	Dp	-	<b>33,5</b>	<b>36,5</b>	
	SD	32,5	<b>34,5</b>	<b>33,5</b>	
	DD	20,0	-	-	
	Bd	43,5	<b>41,0</b>	-	
	BFd	40,0	<b>41,0</b>	-	
Phalanx 2	GL	84,5	<b>81,5</b>	-	
	Bp	45,0	<b>51,5</b>	52,0	
	Dp	-	<b>29,5</b>	-	
	BFp	-	<b>44,5</b>	-	
	SD	-	<b>44,5</b>	-	
	DD	-	<b>22,5</b>	-	
	Bd	43,5	<b>48,0</b>	47,0	
Phalanx 3	GL	47,0	-	43,5	
	Ld	<b>49,0</b>			
	HP	<b>37,0</b>			
	LF	<b>24,0</b>			
	BF	<b>47,5</b>			
	GB	<b>69,0</b>			
	GL	<b>68,0</b>			

Tab. G: Dimenzije izmerjenih ostankov kozoroga (*C. ibex*) s Tonovcovega gradu, datiranih v prvo poznoantično fazo (običajno zapisane številke) oz. drugo poznoantično fazo (krepko zapisane številke). Podatki za najdbe, ki so bile vrsti *C. ibex* pripisane pogojno, so osenčeni. Mere so izražene v mm. Okrajšave: glej von den Driesch 1976.

Tab. G: Dimensions of the measured ibex remains (*C. ibex*) from Tonovcov grad, dated into Late Antiquity phase 1 (written normally), Late Antiquity phase 2 (written in bold letters) and Early medieval phase (written in italics). The data for finds that were conditionally ascribed to the species *C. ibex* are shaded. Measurements are given in mm. Abbreviations see von den Driesch 1976.

<i>C. ibex</i>	Dimenzija Dimension	Meritve Measures		
Humerus	SD	-	<b>19,0</b>	
	Bd	38,0	-	
Radius	Bp	<b>40,5</b>	-	-
	BFp	<b>39,0</b>	-	-
	SD	-	<b>25,0</b>	<b>20,5</b>
Ulna	DPA	37,5	-	
	BPC	-	23,0	
Mc	Bp	27,0		
	SD	18,5		
	Bd	19,0		
Calcaneus	GL	<b>72,5</b>		
	GB	<b>25,5</b>		
Phalanx 1	SD	<b>14,0</b>		
	DD	<b>10,5</b>		
	Bd	<b>16,5</b>		
	GL	<b>44,5</b>		

Tab. H: Dimenzije izmerjenih ostankov pragoveda (*B. primigenius*) s Tonovcovega gradu, datiranih v prvo poznoantično fazo (običajno zapisane številke) oz. drugo poznoantično fazo (krepko zapisane številke). Podatki za najdbe, ki so bile vrsti *B. primigenius* pripisane pogojno, so osenčeni. Mere so izražene v mm. Okrajšave: glej von den Driesch 1976.

Tab. H: Dimensions of the measured aurochs remains (*Bos primigenius*) from Tonovcov grad, dated into Late Antiquity phase 1 (written normally), Late Antiquity phase 2 (written in bold letters) and Early Medieval phase (written in italics). The data from finds that were conditionally ascribed to the species *B. primigenius* are shaded. Measurements are given in mm. Abbreviations see von den Driesch 1976.

<i>B. primigenius</i>	Dimenzija Dimension	Meritve Measures		
Scapula	LG	<b>64,0</b>		
Femur	Bp	136,5		
	DC	54,0		
Tibia	Bp	>90,0	-	-
	Dp	83,0	-	-
	SD	46,5	<b>43,5</b>	<b>45,0</b>
Phalanx 3	Ld	61,0		
	MBS	28,0		
	DLS	83,0		

Tab. I: Dimenzije izmerjenih ostankov psa (*C. familiaris*), srne (*C. capreolus*) in jelena (*C. elaphus*) s Tonovcovega gradu. Vsi podatki se nanašajo na najdbe iz druge poznoantične faze. Mere so izražene v mm. Okrajšave: OnB – obseg na bazi; za ostale okrajšave glej von den Driesch 1976.

Tab. I: Dimensions of the measured dog (*C. familiaris*), roe deer (*C. capreolus*) and red deer (*C. elaphus*) remains from Tonovcov grad. All data is for finds from Late Antiquity phase 2. Measurements are given in mm. Abbreviations: OnB – basal circumference; for other abbreviations see von den Driesch 1976.

Takson Taxon	Skelet. element	Dimenzija Dimension	Meritve Measure
<i>C. familiaris</i>	Epistropheus	BFcr	<b>40,5</b>
<i>C. capreolus</i>	Proc. corn.	OnR	<b>56,0</b>
		OR	<b>110,0</b>
	Mandibula	M15a	<b>24,0</b>
<i>C. elaphus</i>	Proc. corn.	OnR	<b>188,0</b>
	Scapula	LG	<b>44,0</b>
		BG	<b>41,5</b>
	Mt	Bp	<b>40,0</b>

## PRILOGA / APPENDIX 8.2

Tab. A: Število določenih primerkov (NISP) za posamezne taksone velikih sesalcev na območju stavbe 1 na Tonovcovem gradu. Skupina 'Ostalo' vključuje: *Bos taurus* s. *Equus caballus* (N = 1) in Caprinae s. *Capreolus capreolus* (N = 1) za gradivo iz prve poznoantične faze, *Bos taurus* s. *Equus caballus* (N = 1) in Caprinae s. *Capreolus capreolus* (N = 1) za ostanke iz druge poznoantične faze ter *Bos taurus* s. *Equus caballus* (N = 1) in *Bos taurus* s. *Cervus elaphus* (N = 1) za gradivo iz premešanega sedimenta. Pri cervidih je v oklepaju podano število ostankov rogovja. Legenda: PA – poznoantična faza; ZSV – zgodnj srednjeveška faza.

Tab. A: Number of identified specimens (NISP) for individual taxa of large mammals in the area of building 1 at Tonovcov grad. The group "Other" includes: *Bos taurus* s. *Equus caballus* (N = 1) and Caprinae s. *Capreolus capreolus* (N = 1) for the material from Late Antiquity phase 1, *Bos taurus* s. *Equus caballus* (N = 1) and Caprinae s. *Capreolus capreolus* (N = 1) for the remains from Late Antiquity phase 2 and *Bos taurus* s. *Equus caballus* (N = 1) and *Bos taurus* s. *Cervus elaphus* (N = 1) for the material from the mixed sediment. For cervids the number of antler remains is given in the brackets. Legend: LA – Late Antiquity phase; EMA – Early Medieval phase.

Takson Taxon	PA 1 / LA 1		PA 2 / LA 2		ZSV / EMA		Mešano / Mixed	
	NISP	%	NISP	%	NISP	%	NISP	%
<i>Bos taurus</i>	620	40,6	376	19,5	81	20,9	282	22,4
Caprinae	619	40,5	1030	53,5	228	58,8	681	54,0
<i>Sus</i> sp.	247	16,2	467	24,3	69	17,8	260	20,6
<i>Canis familiaris</i>	–	0,0	2	0,1	1	0,3	1	0,1
<i>Capreolus capreolus</i>	–	0,0	4	0,2	1	0,3	1 (1)	0,1
<i>Equus caballus</i>	25	1,6	15	0,8	5	1,3	22	1,7
<i>Cervus elaphus</i>	4	0,3	18 (15)	0,9	1 (1)	0,3	6 (3)	0,5
<i>Capra ibex</i>	4	0,3	7	0,4	–	0,0	3	0,2
<i>Bos</i> cf. <i>primigenius</i>	5	0,3	2	0,1	–	0,0	2	0,2
<i>Ursus arctos</i>	1	0,1	1	0,1	2	0,5	–	0,0
Ostalo / Other	2	0,1	2	0,1	–	0,0	2	0,2
Σ det. fragm.	1527	100,0	1924	100,0	388	100,0	1260	100,0
Σ indet. fragm.	3122 (= 67,1 %N)		4767 (= 71,2 %N)		1033 (= 72,5 %N)		3260 (= 72,1 %N)	
SKUPAJ / TOTAL	4649		6691		1421		4521	

Tab. B: Število določenih primerkov (NISP) za posamezne taksone velikih sesalcev na območju stavbe 2 na Tonovcovem gradu. Skupina 'Ostalo' vključuje: Caprinae s. *Capreolus capreolus* (N = 3). Legenda: PA – poznoantična faza.

Tab. B: Number of identified specimens (NISP) for individual taxa of large mammals in the area of building 2 at Tonovcov grad. The group "Other" includes: Caprinae s. *Capreolus capreolus* (N = 3). Legend: LA – Late Antiquity phase.

Takson Taxon	PA 2 / LA 2	
	NISP	% NISP
<i>Bos taurus</i>	33	35,9
Caprinae	44	47,8
<i>Sus</i> sp.	11	12,0
<i>Capreolus capreolus</i>	1	1,1
Ostalo / Other	3	3,3
Σ det. fragment.	92	100,0
Σ indet. fragment.	125 (= 57,6 %N)	
SKUPAJ / TOTAL	217	

Tab. C: Število določenih primerkov (NISP) za posamezne taksone velikih sesalcev na območju stavbe 3 na Tonovcovem gradu. Legenda: PA – poznoantična faza.

Tab. C: Number of identified specimens (NISP) for individual taxa of large mammals in the area of building 3 at Tonovcov grad. Legend: LA – Late Antiquity phase.

Takson Taxon	PA 1 LA 1	PA 2 LA 2
	NISP	NISP
<i>Bos taurus</i>	26	2
Caprinae	19	8
<i>Sus</i> sp.	4	1
Σ det. fragment.	49	11
Σ indet. fragment.	67	20
SKUPAJ / TOTAL	116	31

Tab. D: Število določenih primerkov (NISP) za posamezne taksone velikih sesalcev na prostoru med srednjo in južno cerkvijo na Tonovcovem gradu. Skupina 'Ostalo' vključuje: *Bos taurus* s. *Equus caballus* (N = 3) in Caprinae s. *Capreolus capreolus* (N = 6) za gradivo iz druge poznoantične faze, *Bos taurus* s. *Cervus elaphus* (N = 1) za ostanke iz zgodnj srednjeveške faze ter Caprinae s. *Capreolus capreolus* (N = 2) za gradivo iz premešanega sedimenta. Legenda: PA – poznoantična faza; ZSV – zgodnj srednjeveška faza.

Tab. D: Number of identified specimens (NISP) for individual taxa of large mammals in the courtyard area between the two churches at Tonovcov grad. The group "Other" includes: *Bos taurus* s. *Equus caballus* (N = 3) and Caprinae s. *Capreolus capreolus* (N = 6) for the material from Late Antiquity phase 2, *Bos taurus* s. *Cervus elaphus* (N = 1) for the remains from Early Medieval phase and Caprinae s. *Capreolus capreolus* (N = 2) for the material from the mixed sediment. Legend: LA – Late Antiquity phase; EMA – Early Medieval phase.

Takson Taxon	PA 2 / LA 2		ZSV / EMA		Mešano / Mixed	
	NISP	% NISP	NISP	% NISP	NISP	% NISP
<i>Bos taurus</i>	56	46,3	1	–	42	30,2
Caprinae	38	31,4	2	–	75	54,0
<i>Sus</i> sp.	17	14,0	1	–	18	12,9
<i>Canis familiaris</i>	1	0,8	–	–	–	0,0
<i>Capreolus capreolus</i>	–	0,0	–	–	2	1,4
Ostalo / Other	9	7,5	1	–	2	1,4
Σ det. fragment.	121	100,0	5	–	139	100,0
Σ indet. fragment.	227 (= 65,2 %N)		6		275 (= 66,4 %N)	
SKUPAJ / TOTAL	348		11		414	

## 9. SHORT CONSIDERATIONS ON THE BIRD REMAINS

### 9. KRATKE UGOTOVITVE O PTIČJIH OSTANKIH

Francesco BOSCHIN

About 189 bird remains were collected during the excavations on Tonovcov grad. Many of them (169, see *Tab. 9.1*) are identified as domestic hen (*Gallus gallus* f. *domestica*) whilst other rare fragments remain unidentified. Two of them belong probably to other species but due to the bad preservation it is impossible to tell which ones. The strong fragmentation also characterizes the hen bones and only a part of them is measurable, following the method proposed by von den Driesch (1976).

The bones were represented in all phases. The majority of them was found in the vicinity of building 1 or, infrequently, inside it. The largest concentration is located in the quadrants to the northwest and northeast of building 1. The abundance of sediment there enabled sieving the soil (see Tonovcov grad. Settlement remains and interpretation, chapter 2.1). Only three fragments originate from excavation areas of other structures.

In all the phases hen bones are scarce in comparison with mammal remains. Considering the fragility and thinness of hen bones this is not surprising. The most abundant elements are in fact the humerus, the coracoid, the femur and the tibiotarsus that show stronger corpus and epiphyses. Hen bones are always affected by post-depositional attrition, and less frequently by human behaviour such as differential transport, heavy butchering or cooking. Probably the body part profiles

Phase / Faza	1	1/2	2	3
sternum			2	
coracoideum	5	2	13	3
scapula			4	1
humerus	2	5	20	3
ulna	2		14	2
radius	2		4	2
carpometacarpus	2		3	
coxae	1	1	1	
ischiacrum			1	1
femur	2	5	10	8
tibiotarsus	7	5	21	7
tarsometatarsus	1	1	4	2
Total / Skupaj	24	19	97	29

Pri arheoloških izkopavanjih na Tonovcovem gradu je bilo najdenih 189 ostankov ptic. Velika večina (N = 169; *tab. 9.1*) jih pripada domači kokoši (*Gallus gallus* f. *domestica*); ostalih spričo slabe ohranjenosti kostne substance ni bilo mogoče ožje taksonomsko opredeliti. Kljub temu se zdi verjetno, da sta med slednjimi najmanj dva primerka pripadala neki drugi vrsti ptic. Izrazita fragmentiranost sicer označuje tudi ostanke kokoši, zato je število merljivih kosti razmeroma skromno. Pri zajemanju metričnih podatkov sem sledil smernicam von den Driescheve (1976).

Ptičji ostanki so zastopani v gradivu iz vseh treh poselitvenih faz, v prostorskem smislu pa večinoma izvirajo iz okolice stavbe 1 oziroma – v precej manjši meri – iz njene notranjosti. Večina najdb je ležala v kvadrantih severozahodno in severovzhodno od omenjene stavbe. Na tem območju je bila namreč plast sedimenta najdebelejša, kar je omogočilo izvedbo sejanja kulturne plasti (Tonovcov grad. Naselbinski ostanki in interpretacija, pogl. 2.1). Na drugih delih izkopnega polja so bili najdeni zgolj trije ptičji ostanki.

Število kokošjih ostankov v gradivu iz vseh treh poselitvenih faz očitno zaostaja za številom ostankov sesalcev. Ugotovitev ni presenetljiva, saj so ptičje kosti votle in relativno krhke. Najbolje zastopani skeletni elementi so tako prav humerus, korakoid, femur in tibiotarsus, ki jih označujejo robustnejši dia- in epifizi. Praktično vse kokošje kosti so ogluljene, kar pripisujem drgnjenju v samem sedimentu, medtem ko je pogostnost sledi človekove aktivnosti (npr. razkosavanje, kuhanje) skromna. V vzorcu zastopanosti posameznih skeletnih elementov tako najbrž odsevajo predvsem razlike v strukturni gostoti kostne substance med njimi, čeprav bi prevlado distalnih delov tibiotarzusa nad proksimalnimi lahko povezali tudi s kuhanjem (*cf. Gál 2005*).

*Tab. 9.1:* Tonovcov grad. Hen bones per phase.

*Tab. 9.1:* Tonovcov grad. Kokošje kosti po fazah.

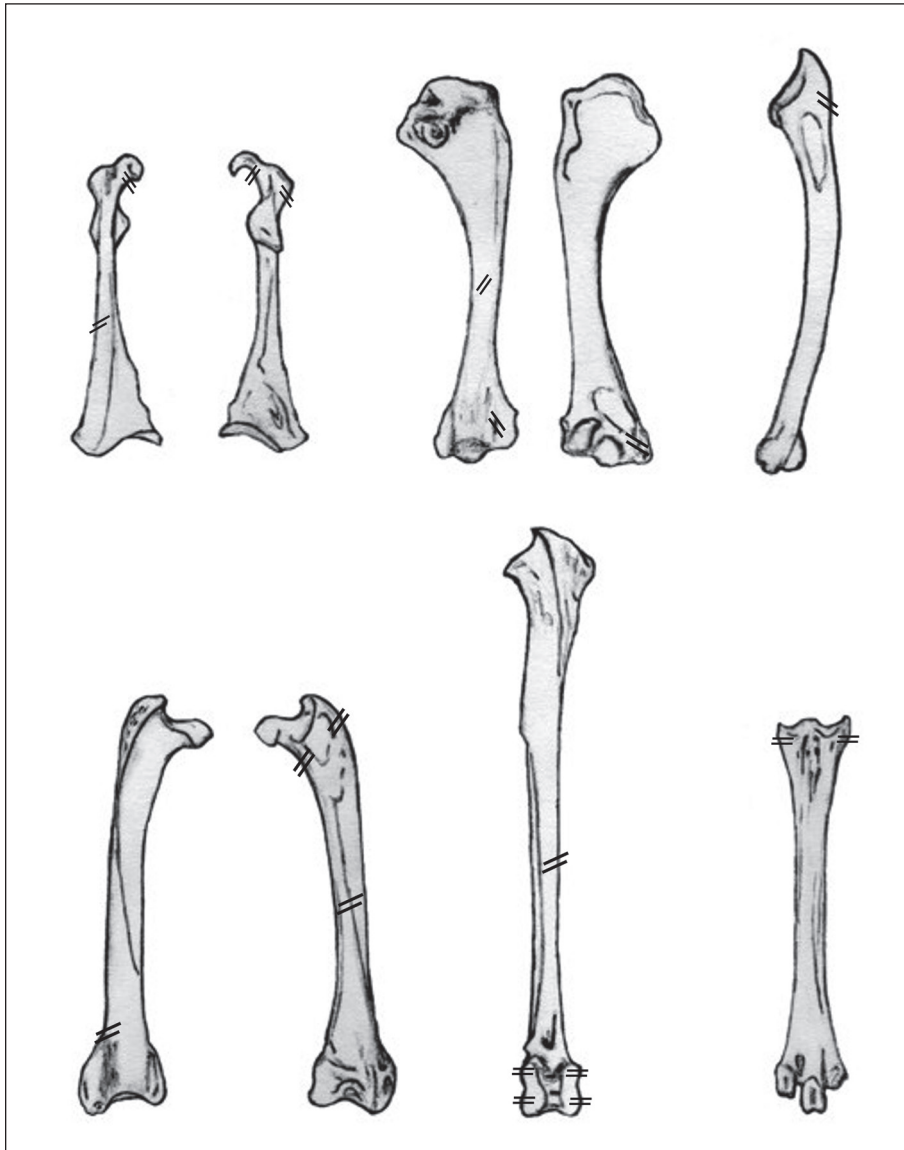

Fig. 9.1: Locations of the cut marks identified on the hen bones from Tonovcov grad.  
Sl. 9.1: Mesta sledov vrezov na kokošnjih kosteh s Tonovcovega gradu.

is mostly influenced by bone density and its mechanical resistance, but the relative high abundance of the distal extremity of the tibiotarsus in comparison with the proximal one, can be explained by cooking activities as suggested for instance by Gál (2005).

Butchering marks are present on 21 bones from all phases. They consist of knife cuts located usually on long bones extremities, to disarticulate the carcasses. Several marks are located on the distal articular surface of the tibiotarsus in order to separate the meatless extremities (Fig. 9.1). Only 2 bones are burnt.

The measurements are given in Tab. 9.2. Due to the fragmentation of the specimens, the length of the bones is usually indeterminate, therefore the animal

Na delu kokošnjih kosti iz vsake od treh poselitvenih faz so bile opažene posamezne sledi, ki so nastale med razkosavanjem živali. Gre za ureze, ki so večinoma prisotni na dolgih kosteh okončin. Prevladujejo tisti na distalnem delu tibiotarzusa, ki so nastali med odstranjevanjem kulinarično nezanimivih spodnjih delov nog (sl. 9.1). Nekaj kosti je ožganih.

Metrični podatki kokošnjih ostankov s Tonovcovega gradu so podani v tabeli 9.2. Zaradi fragmentiranosti najdb največje dolžine praviloma ni bilo mogoče izmeriti. To je močno otežilo oceno velikost obravnavanih kokoši, zaradi nezmožnosti verodostojne rekonstrukcije spolne strukture pa tudi primerjavo pridobljenih ocen s podatki z drugih najdišč. Dodatno težavo v tem smislu

Tab. 9.2: Hen measurements from Tonovcov grad. Kratice: GL – največja dolžina; Lm – dolžina na medialni strani; Bb – (največja) širina bazalnega dela; BF – širina facies articularis basalis; Dic – (največja) širina kranialnega dela, merjena diagonalno; Bp – širina proksimalnega konca; Bd – širina distalnega konca; SC – najmanjša širina korpusa; Dip – (največja) širina proksimalnega konca, merjena diagonalno; Did – (največja) širina distalnega konca, merjena diagonalno; Dd – globina distalnega konca.

Tab. 9.2: Meritve kokoši s Tonovcovega gradu. Abbreviations: GL – greatest; Lm – medial; Bb – (greatest) basal breadth; BF – breadth of the basal articular surface; Dic – (greatest) cranial diagonal; Bp – breadth of the proximal end; Bd – breadth of the distal end; SC – smallest breadth of the corpus; Dip – (greatest) diagonal of the proximal end; Did – (greatest) diagonal of the distal end; Dd – depth of the distal end.

Phase	Element	Measurements / Meritve													
1	coracoideum	GL	55,8	Lm	53,3	Bb	15,5	BF	13						
1/2	coracoideum					Bb	11,7	BF	10,3						
2	coracoideum	GL	50,7	Lm	49,1	Bb	15,3	BF	13						
2	coracoideum	GL	46,7	Lm	45,3	Bb	12	BF	9,7						
2	coracoideum	GL	49,5	Lm	47,2			BF	10						
2	coracoideum	GL	56,6	Lm	53,3			BF	12,6						
2	coracoideum	GL	54,6												
3	coracoideum	GL	51	Lm	49,1			BF	10,5						
3	coracoideum	GL	48,4	Lm	47,3			BF	8						
2	scapula	Dic	11,3												
2	scapula	Dic	10,5												
2	scapula	Dic	12												
1	humerus					SC	6,4								
1/2	humerus	GL	61,3	Bp	16,9	SC	5,9	Bd	12,7*						
1/2	humerus					SC	6	Bd	13,3						
2	humerus	GL	60,5	Bp	17	SC	6	Bd	13						
2	humerus			Bp	19,6	SC	6,3								
2	humerus					SC	6,4	Bd	14,9						
2	humerus					SC	5,8	Bd	13,3*						
2	humerus					SC	6								
2	humerus							Bd	14,2						
2	humerus							Bd	13,5						
2	humerus							Bd	15,8						
3	humerus					SC	5,5	Bd	12,5						
1	radius			Bd	5,5										
2	radius	GL	66	Bd	6,5										
2	radius	GL	58	Bd	6										
2	radius			Bd	6										
2	radius			Bd	5,8										
1	ulna			SC	4,3	Did	9,5								
2	ulna	Bp	9,4												
2	ulna	Bp	9												
2	ulna			SC	3,4	Did	8,8								
2	ulna			SC	3,8	Did	9								
2	ulna			SC	3,5	Did	8,2								
2	ulna					Did	8,7								
2	ulna					Did	10								
1	carpometacarpus	Bp	10,7	Did	6,4										
1	carpometacarpus			Did	7										
2	carpometacarpus			Did	6,9										
2	carpometacarpus			Did	6										
1	femur							Bd	13	Dd	10,5				
1	femur							Bd	13,2	Dd	8,7				
1/2	femur	GL	67,6	Lm	67	Bp	12,7	Dp	9	SC	6	Bd	12,3	Dd	9,5
1/2	femur											Bd	14,6	Dd	12,2
2	femur	GL	82	Lm	77	Bp	17	Dp	11	SC	7	Bd	16,2	Dd	13,4

Phase	Element					Measurements / Meritve								
2	femur	Lm	73,5						SC	7				
2	femur			Bp	14	Dp	9,5	SC	5,6					
2	femur										Bd	13,5		
3	femur			BP	15,5	Dp	11							
3	femur										Bd	12,5	Dd	10,6
3	femur										Bd	15	Dd	12,3
1	tibiotarsus			Dip	20,3									
1	tibiotarsus								Bd	11,3	Dd	11,3		
1/2	tibiotarsus			Dip	17									
1/2	tibiotarsus								Bd	9,5	Dd	10		
1/2	tibiotarsus								Bd	9,6	Dd	10,1		
1/2	tibiotarsus								Bd	10,5	Dd	10		
2	tibiotarsus	GL	112	La	109	Dip	20,5	SC	6,2	Bd	11,4	Dd	12	
2	tibiotarsus					Dip	21,4							
2	tibiotarsus					Dip	21,4							
2	tibiotarsus							SC	5,5	Bd	9,5	Dd	11*	
2	tibiotarsus							SC	5,4	Bd	10	Dd	10,5	
2	tibiotarsus							SC	5,4	Bd	9,8	Dd	10,7	
2	tibiotarsus							SC	5	Bd	9,5	Dd	10,3	
2	tibiotarsus							SC	5,2	Bd	9,5			
2	tibiotarsus							SC	6,7					
2	tibiotarsus							SC	5,5					
2	tibiotarsus							SC	6,8					
2	tibiotarsus									Bd	11,5	Dd	13,6	
2	tibiotarsus									Bd	9	Dd	10	
2	tibiotarsus									Bd	11	Dd	11	
2	tibiotarsus									Bd	11,4	Dd	13,1	
3	tibiotarsus									Bd	9,6	Dd	10,5	
1	tarsometatarsus ♀	GL	66,3	Bp	11,7	SC	5,6	Bd	11,7					
1/2	tarsometatarsus			Bp	11,1									
2	tarsometatarsus			Bp	12,6									
3	tarsometatarsus ♀	GL	63,4	Bp	10,6	SC	5,3	Bd	10,7					

\* uncertain measurement / negotova meritvev

size is difficult to estimate. It is possible to compare the population from Tonovcov grad with others, but some problems should be considered. First, a comparison between unsexed bones is difficult, because the sex ratio can strongly influence the average size values and their numerical dispersion, and second, the fragility of the bones in many cases does not permit the survivorship of a representative sample. Afterwards, but less important, there is a lack of data from Slovenia and data from neighbouring regions are also scarce.

The first poultry populations in Europe, coming from the Near East (the first domestication is attested in China during the 6<sup>th</sup> millennium BC as reported for instance by Chow Ben-Shun, 1984) are attested during the Ha C and Ha D phases (Benecke 1993). Those individuals were characterised by a small size. During Roman period, hen populations show a bigger variability and usually the body dimensions increase. This trend

predstavlja pičlost merljivih kosti s Tonovcovega gradu, kakor tudi pomanjkanje primerjalnih podatkov za območje Slovenije oziroma njihova maloštevilnost na najdiščih v sosednjih pokrajinah.

Perutnina je bila v Evropo privedena z Bližnjega vzhoda v starejši železni dobi, v stopnji Ha C in Ha D<sup>1</sup> (Benecke 1993). Šlo je za živali, ki so bile razmeroma majhne. Rimskodobne kokoši so bile v povprečju nekoliko večje, takratne populacije pa sicer izkazujejo tudi nekoliko večjo stopnjo variabilnosti. Navedeni trend je bil opažen tako v Italiji kot tudi v srednji Evropi (glej npr. Thesing 1977; Riedel 1993; Petrucci, Vitri 1995; De Grossi Mazzorin 2005). Od tega obdobja dalje lahko govorimo o obstoju več različnih pasem, ki so se med seboj razlikovale tako v velikosti kot tudi v robustnosti.

<sup>1</sup> Do prve udomačitve kokoši naj bi sicer prišlo na Kitajskem v šestem tisočletju pr. n. št. (Chow Ben-Shun 1984).



is attested in different regions, such as for instance Italy and Central Europe (see Thesing 1977; Riedel 1993, Petrucci and Vitri 1995; De Grossi Mazzorin 2005). In this period, and later, the presence of more breeds that show different size and robustness is also attested.

After the Roman period the chronological evolution of the body size differs from region to region.

For instance in Rome the size increases during the Late Antiquity (De Grossi Mazzorin 2005) and then decreases in the Early Medieval period.

In Verona in the Po Plain (Riedel, Rizzi 2000) the body size is large and remains similar from the Late Antiquity till Early Medieval period, whilst north of the Alps in central Europe it decreases during the Late Antiquity and remains similar (with local oscillations) in the Early Middle Ages (Thesing 1977).

Although among the material from Tonovcov grad only two tarsometatarsal are sexed, the size of the individuals herded in the site is included in the variability of the period. No diachronical changes are observed in morphology and size. However the individuals seem smaller than the average values observed for instance both in Rome (De Grossi Mazzorin 2005) and in Verona (Riedel, Rizzi 2000). The data suggests a possible similarity with the situation observed in central Europe by Thesing (1977) or by other authors (see for instance the Avar cemetery of Vösendorf-Laxenburgerstraße in the Mödling district near Wien, Pucher et al. 2007).

In Slovenia only a few measurements are available from the Iron Age site of Kučar (unpublished data) and from the Roman sites of Školarice and Emona (Ljubljana-Opera house, unpublished data), and all of them seem to be in line with the trends of their relative periods, but obviously more data is needed to describe the chronological evolution of the poultry in the region and its significance in a wider geographical vision.

The importance of the material from Tonovcov grad is that, in spite of the small sample, it represents one of the first contributions to this kind of research in Slovenia.

Po koncu rimskega obdobja se pojavijo očitne medregionalne razlike v razvojni stopnji kokošereje. V Rimu se je tako trend povečevanja kokoši nadaljeval še tudi v pozni antiki, tako da do obrata pride šele z nastopom zgodnjega srednjega veka (De Grossi Mazzorin 2005). Šele takrat je bilo zmanjšanje velikosti kokoši ugotovljeno tudi v Veroni (Riedel, Rizzi 2000), medtem ko se je to severno od Alp ter drugod v srednji Evropi zgodilo že v pozni antiki. Nastop zgodnjega srednjega veka v ta prostor ni prinesel dodatnih sprememb (Thesing 1977).

Žal je bilo mogoče v gradivu s Tonovcovega gradu spol z zanesljivostjo določiti zgolj v primeru dveh tarzometatarsusov, ki pa se oba umeščata znotraj variacijske širine za sočasne primerke v regiji in njeni soseščini. Diahronih sprememb v velikosti in morfologiji nisem zasledil, so pa razpoložljivi primerki na pogled manjši od povprečnih vrednosti za kokoši iz Rima (De Grossi Mazzorin 2005) in Verone (Riedel, Rizzi 2000). Sklepamo torej lahko na podobnost s stanjem, ki ga za območje srednje Evrope podajajo Thesing (1977) in drugi avtorji (glej npr. avarsko grobišče Vösendorf-Laxenburgerstraße v okrožju Mödling pri Dunaju; Pucher et al. 2007).

Za območje Slovenije je nekaj neobjavljenih podatkov o velikosti kokoši razpoložljivih zgolj za železnodobno naselbino Kučar ter rimskodobni najdišči Školarice in Emona (SNG Opera). Ti v ničemer ne odstopajo od zgoraj opisanih splošnih trendov za posamezno obdobje oziroma območje, bi pa bilo za izpeljavo celovitejših interpretacij seveda potrebno število danes razpoložljivih metričnih podatkov bistveno obogatiti.

Pomen gradiva s Tonovcovega gradu tiči prav v tem, da navkljub skromnemu vzorcu predstavlja prvi prispevek k tovrstnim raziskavam na Slovenskem.

## BIBLIOGRAPHY / LITERATURA

Tonovcov grad. Naselbinski ostanki in interpretacija / Tonovcov grad. Settlement remains and interpretation = Ciglencečki, Modrijan, Milavec 2011.

BENECKE, N. 1993, On the utilization of the domestic fowl in Central Europe from the Iron age up to the Middle Ages. – *Archaeofauna* 2, 21–31.

BEN-SHUN, C. 1984, Animal domestication in Neolithic China. – In / V: J. Clutton-Brock, C. Grigson (eds. / ur.) *Animals and Archaeology 3: Early Herders and their Flocks*. BAR. International Series 202, 363–369.

CIGLENEČKI, S., Z. MODRIJAN in / and T. MILAVEC 2011, *Tonovcov grad. Naselbinski ostanki in interpretacija / Tonovcov grad. Settlement remains and interpretation*. – Opera Instituti Archaeologici 23.

DE GROSSI MAZZORIN, J. 2005, Introduzione e diffusione del Pollame in Italia ed evoluzione delle sue forme di allevamento fino al Medioevo. – In / V: I. Fiore, G. Malerba., S. Chilardi (eds. / ur.), *Atti del 3° Convegno Nazionale di Archeozoologia (Siracusa, 2000)*. *Studi di Paletnologia II, Collana del Bullettino di Paletnologia Italiana*, 351–361.

DRIESCH, A. von den 1976, A Guide to The Measurement of Animal Bones from Archaeological Sites. – *Peabody Museum Bulletin* 1.

GÁL, E. 2005, New evidence of fowling and poultry keeping in Pannonia, Dacia and Moesia during the Period of the Roman Empire. – In / V: G. Grupe, J. Peters (eds. / ur.), *Feathers, Grit and Symbolism, Birds and humans in the ancient old and new worlds*, Proceedings of the 5<sup>th</sup> Meeting of the ICAZ Bird Working Group in Munich (26.7 - 28.7.2004), *Documenta Archaeobiologiae* 3.

PETRUCCI, G. and / in S. VITRI 1995, Resti di fauna da strutture in fossa della romanizzazione da Montereale Valcellina (PN). – *Padusa Quaderni* 1, 235–254.

PUCHER, E., T. BRUCKNER, A. BAAR, G. DISTELBERGER, B. ÖHLINGER and / in V. ZHEDEN 2007, Tierskelette und Tierknochen aus dem awarischen Gräberfeld von Vösendorf-Laxenburgerstraße. – *Fundberichte aus Österreich* 45, 481–520.

RIEDEL, A. 1993, Die Tierknochenfunde des römischen Lagervicus von Treismauer/Augustiana in Niederösterreich. – *Annalen des Naturhistorischen Museums in Wien* 95 serie A, 179–294.

RIEDEL, A. and / in RIZZI J. 2000, Studio preliminare su resti ossei di avifauna di Verona medievale (scavi di piazza Mercato Vecchio e del Tribunale). – In / V: I. Fiore, G. Malerba., S. Chilardi (eds. / ur.), *Atti del 2° Convegno Nazionale di Archeozoologia (Asti, 1997)*, 341–348, Forlì.

THESING, R. 1977, *Die Größenentwicklung des Haushuhns in vor- und frühgeschichtlicher Zeit*. – Inaugural-Dissertation zur Erlagerung der tiermedizinischen Doktorwürde der Tierärztlichen Fakultät der Ludwig-Maximilians-Universität München.

# 10. RESULTS OF MICROSCOPIC COMPOSITIONAL ANALYSIS ON COARSE-WARE CERAMICS

## 10. REZULTATI MIKROSKOPSKE ANALIZE GROBE KERAMIKE

K. Patrick FAZIOLI

### 10.1 INTRODUCTION

The ceramic assemblage at the site of Tonovcov grad near Kobarid presents an excellent opportunity to investigate technological aspects of coarse-ware pottery production in the Late Antique and Early Medieval periods of western Slovenia. Towards this end, twenty-three samples of coarse-ware pottery were thin-sectioned and subject to compositional analyses under a polarizing light microscope. This short report details the methodology and results of this analysis and offers some tentative conclusions concerning the transition from Late Antiquity to the Early Middle Ages at this settlement in terms of ceramic technology.

### 10.2 SAMPLING STRATEGY

The petrographic analysis was intentionally restricted to coarse-ware pottery at the site, which is believed to have been locally manufactured. The analysis was conducted on ceramics primarily from Building 1, which contained stratigraphic layers dating to each of the three primary occupation phases: Late Antique 1 (LA 1, c. 350-450), Late Antique 2 (LA 2, c. 475-625), and Early Medieval (EMP, c. second half of the 7<sup>th</sup> century -800; see also Tonovcov grad, Settlement remains and interpretation, chapter 2.2). Samples were chosen for petrographic analysis based upon macroscopic fabric categories identified by Z. Modrijan<sup>1</sup>, in order to ensure a representative sample of the wider coarse-ware ceramic assemblage at the site. The macroscopic analysis distinguished fifteen fabric types, none of which was restricted to a single occupational phase at the site; rather, each of the macroscopic fabric groups contained ceramics from to least two, and sometimes all three, of the phases, although often in markedly different proportions (see Fig. 4.9). Since the transition from Late Antiquity to the Early Middle Ages was the primary focus of this petrographic analysis, a minimum of two ceramic sherds

<sup>1</sup> Modrijan 2008, 81-94.

### 10.1 UVOD

Keramična zbirka na najdišču Tonovcov grad pri Kobaridu nudi izredno priložnost za raziskovanje tehnoloških vidikov proizvodnje grobe keramike v pozni antiki in zgodnjem srednjem veku v zahodni Sloveniji. Zato je bilo pod mikroskopom s polarizacijsko lučjo analiziranih triindvajset zbruskov grobe keramike. V prispevku razlagamo metodologijo in rezultate teh analiz in ponujamo previdne zaključke o prehodu pozne antike v zgodnji srednji vek na najdišču, kot so razvidne iz tehnologije keramike.

### 10.2 STRATEGIJA VZORČENJA

Petrografske analize so bile usmerjene na grobo keramiko, za katero domnevamo, da je bila izdelana lokalno. Analiza je bila omejena predvsem na keramiko iz stavbe 1, ki je vsebovala plasti iz vseh treh glavnih poselitvenih faz: prve poznoantične faze (PA 1, pribl. 350-450), druge poznoantične faze (PA 2, pribl. 475-625) in zgodnjega srednjega veka (ZSV, pribl. druga polovica 7. st.-800; glej tudi Tonovcov grad. Naselbinski ostanki in interpretacija, pogl. 2.2). Vzorci za analizo so bili izbrani na osnovi makroskopskih skupin, ki jih je določila Z. Modrijan,<sup>1</sup> da bi na njihovi podlagi dobili presek čez najširši keramični sklop na najdišču. Pri makroskopskih analizah keramike je bilo ugotovljenih 15 fakturnih skupin, nobena od njih pa ni bila omejena na eno samo poselitveno fazo na najdišču, celo nasprotno – vsaka od fakturnih skupin je obsegala keramiko iz vsaj dveh, pogosto pa tudi iz vseh treh poselitvenih faz, čeprav v opazno različnih razmerjih (glej sl. 4.9).

Ker je bil primarni cilj petrografske analize prehod iz pozne antike v zgodnji srednji vek, smo po najmanj dva vzorca izbrali iz tistih makroskopskih skupin, ki so prevladovali v plasteh faze PA 2 in v zgodnesrednjeveških plasteh. Med njimi so tehnološke skupine 5 in 10, ki vsebujejo največje število odlomkov iz zgodnesrednjeveških

<sup>1</sup> Modrijan 2008, 81-94.

were chosen from those macroscopic fabric groups most prevalent during the LA 2 and EMA phases at the site. This included fabric groups 5 and 10, which had the greatest proportion of Early Medieval ceramics, as well as fabric groups 2, 8, 9, and 13, which were predominantly from the Late Antique 2 phase. Fabric groups 3 and 6, comprising of ceramics primarily from the Late Antique 1 phase, were also included in the analysis as a point of comparison.

### 10.3 METHODOLOGY

While a comprehensive explanation of ceramic petrography is beyond the scope of this chapter<sup>2</sup>, a brief synopsis is provided below for those unfamiliar with this methodology. The analysis requires the creation of a ceramic 'thin section', whereby a small sample (c. 2 x 3 cm) of a ceramic vessel is ground to approximately 0.03 mm in thickness and mounted on a glass slide. Since most of the coarse-ware pottery in this analysis was relatively low-fired and quite friable, a resin epoxy was impregnated into each sample to hold the fabric together during the grinding process. Some samples were also stained with alizarin red-S, which allows one to distinguish different types of carbonates in the pottery fabric.

The thin section can be observed under a polarizing light (or petrographic) microscope (see Fig. 10.1). Three major components of the ceramic fabric can be assessed microscopically: the matrix (or groundmass), non-plastic inclusions, and voids. The term *matrix* describes the very fine-grained materials (<30  $\mu$  m fraction) in which coarser particles are embedded. It is characterized by fracture, color, and birefringence (i.e. anisotropic or optically active). The term *non-plastic inclusion* encompasses all coarser rock, mineral and organic materials present in the matrix, including those both naturally present and artificially added (i.e. temper). Most mineral inclusions can be identified based upon a range of optical properties (shape, color, relief, cleavage, pleochroism, birefringence, extinction, opacity) under plane and cross-polarized light<sup>3</sup>. After identification, the non-plastic inclusions are then described in terms of their abundance, roundedness, size, orientation, sortedness, or other meaningful properties<sup>4</sup>. Lastly, the term *void* refers to pores in the matrix that once held non-plastic inclusions prior to firing; these can also be described in terms of their abundance and shape.

<sup>2</sup> Refer to Whitbread 1995 or Mason 2004 for excellent summaries of this method.

<sup>3</sup> Kerr 1977 provides a detailed description of identifying minerals in thin section

<sup>4</sup> For example, carbonates can be distinguished between those with large (sparry) or small (micritic) crystal size, as well as the degree of disintegration into lime mud. Quartz can also be distinguished by cloudiness and type of extinction.

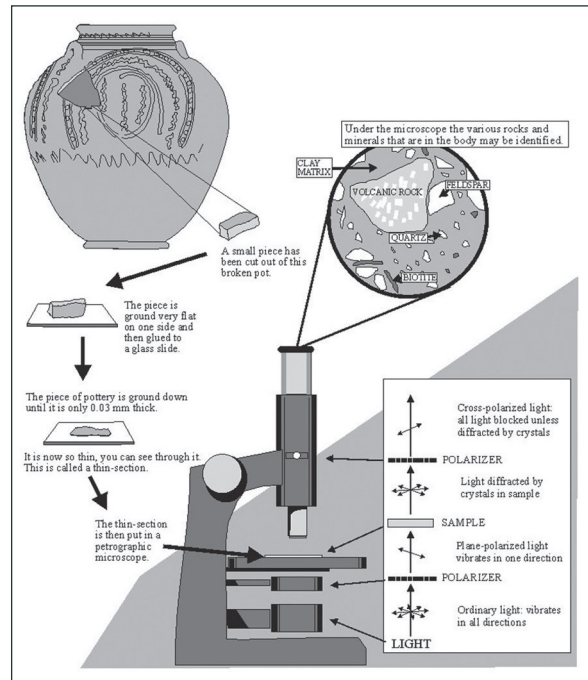

Fig. 10.1: Basic Steps of Optical Microscopy for Archaeological Ceramics. Source: Mason 2004, 22.

Sl. 10.1: Osnovni postopki optične mikroskopije za arheološko keramiko (po Mason 2004, 22).

plasti, pa tudi 2, 8, 9 in 13, kjer prevladuje keramika iz faze PA 2. Skupini 3 in 6, v katerih prevladuje keramika iz faze PA 1, sta bili v analizo vključeni kot primerjava.

### 10.3 METODOLOGIJA

Izčrpna razlaga petrografskih analiz keramike presega namen tega prispevka,<sup>2</sup> kljub temu pa bomo podali kratek povzetek za bralce, ki jim ta metodologija ni boljše poznana.

Prvi pogoj za analizo je izdelava keramičnih zbruskov, pri kateri se majhen fragment keramične posode (pribl. 2 x 3 cm) zbrusi do debeline pribl. 0.03 mm in pritrdi na stekleno ploščico. Ker je bila večina grobe keramike, uporabljene pri tej analizi, slabo žgana in precej drobljiva, je bil vsak vzorec prepojen z epoksi smolo, ki je preprečevala, da bi vzorec med brušenjem razpadel. Nekaj vzorcev je bilo premazanih tudi z alizarin S-rdečim barvilom, kar je omogočilo razlikovanje različnih tipov karbonatov.

Zbruske lahko opazujemo pod polarizacijskim mikroskopom (sl. 10.1), kjer je mogoče oceniti tri glavne komponente keramične zmesi: matriko (osnovno zmes), neplastične vključke in praznine. Termin *matrika* označuje zelo fino zrnat material (frakcija

<sup>2</sup> Odličen povzetek te metode pri Whitebread 1995 ali Mason 2004.

Although the basic principles of ceramic petrographic analysis are universally accepted, it should be noted that a number of different techniques can be employed for recording and presenting this data, depending on the preference of the analyst<sup>3</sup>.

## 10.4 RESULTS

The results of petrographic analysis on the twenty-three samples reveal that most of the coarse-ware ceramics contained the same basic mineralogical components: quartz, calcium carbonates, micas, and (very occasional) feldspars. This is unsurprising given the regional geology and presumed local manufacture of this pottery. Four distinct mineralogical groups (A-D) were identified based on the presence/absence, proportion, and character of these different minerals. *Table 10.1* summarizes these groups, and a full description of each petrographic group is provided in the appendix.

*Tab. 10.1*

Fabric Group Fakturna skupina	# Samples Št. vzorcev	Quartz % Kremen %	Carbonate % Karbonat %	Mica % Sljuda %
TG - A	3	0 - <1 %	20 - 25 %	0 - 1 %
TG - B	4	2 - 5 %	0 - 5 %	0 - 2 %
TG - C	2	8 %	20 %	<1 - 1 %
TG - D	14	2 - 6 %	15 - 30 %	1 - 3 %

It should be observed that creating a ceramic compositional typology always includes a degree of subjectivity, since a range of variation always exists within each of the petrographic groups. The goal is to identify those differences among groups that are thought to be archaeologically meaningful; that is, they could reflect different technological choices made in the manufacturing process. For this reason, mineralogical group TG-D was further divided into three subgroups based upon the color of the paste, which has important implications for the firing temperature and atmosphere (*tab. 10.2*).

The petrographic analysis confirms the basic conclusion of the macroscopic analysis: there existed a high degree of continuity in ceramic technological traditions throughout the phases under consideration. Petrographic groups TG-D and TG-B, which constituted 78 % of the analyzed samples, included a roughly equal number of ceramics from different chronological phases, strongly suggesting continuity in ceramic technology from Late Antiquity to the Early Middle Ages. Some degree of dis-

<sup>3</sup> The methodology adopted here most closely follows that of Mason 2004. For example, abundance is qualitatively determined through the use of comparison charts (following Terry and Chillingar 1955) rather than point-counting methods (cf. Stoltman 1989). The division between 'coarse' and 'fine' quartz falls around 0.5 mm.

<30  $\mu$  m), ki vsebuje tudi bolj grobe delce. Določena je s prelomom, barvo in dvolomom, ki je lahko anizotropen ali optično aktiven. Izraz *neplastični vključki* obsega vse bolj grobe (kamnine, rudnine in organske ostanke) delce v zmesi, tako naravne kot umetno dodane. Večino mineralnih vključkov je mogoče identificirati po vrsti vidnih lastnosti (oblika, barva, relief, mnogobarvitost ali pleohroizem, dvolom, propad, svetlobna nepropustnost) pod navadno in polarizacijsko svetlobo.<sup>3</sup> Po določitvi se neplastični vključki opišejo glede na njihovo pogostost, zaobljenost, usmerjenost, uvrščanje ali druge pomembne lastnosti.<sup>4</sup> Zadnji termin, *praznina*, se nanaša na pore, ki so pred žganjem vsebovale neplastične vključke. Tudi ta izraz je lahko opisan glede na pogostost in obliko. Čeprav so osnovna načela petrografske analize keramike splošno sprejeta, je treba poudariti, da je število različnih tehnik, ki jih lahko uporabimo za zapisovanje in predstavitev teh podatkov, odvisno od posameznega raziskovalca.<sup>5</sup>

## 10.4 REZULTATI

Rezultati petrografske analize triindvajsetih vzorcev kažejo, da večina grobe keramike vsebuje iste osnovne mineraloške komponente: kremen, kalcijev karbonat, sljudo in (zelo redko) zdrobljeno keramiko, kar kaže na lokalni izvor surovine in predpostavlja lokalni izvor keramike. Na podlagi prisotnosti oz. odsotnosti, velikosti in vrste mineralov so bile identificirane štiri mineraloške skupine (A-D). *Tabela 10.1* kaže pregled teh skupin, popoln opis pa je podan v dodatku.

Izdelava keramične tipologije vedno vsebuje določeno stopnjo subjektivnosti, saj znotraj posameznih petrografske skupin vedno obstaja stopnja variacije. Potrebno je torej identificirati tiste razlike med skupinami, za katere domnevamo, da bi lahko bile arheološko izpovedne, to

<sup>3</sup> Kerr 1977 prinaša natančen opis določanja mineralov v zbrusku.

<sup>4</sup> Pri karbonatih lahko na primer ločimo tiste z veliko ali manjšo velikostjo kristalov, pa tudi stopnjo razpada v apnenčev mulj. Kremen se lahko razlikuje po motnosti in načinu propadanja.

<sup>5</sup> Metodologija, uporabljena pri pričujoči analizi, sledi metodi, uporabljeni v Mason 2004, kjer je npr. pogostost kvalitativno določena z uporabo primerjalnih tabel (po Terry, Chillingar 1955), ne pa z metodo štetja (Stoltman 1989). Razlika med "grobim" in "finim" kremenom je pri pribl. 0,5 mm.

continuity is perhaps indicated by group TG-A, which only contained ceramics from Late Antiquity, and TG-C, which only contained ceramics from the Early Middle Ages, although the relatively small sample size should be noted. *Table 10.2* divides the samples by mineralogical group and chronology; the Roman numerals indicate the macroscopic fabric group of each sample.

*Tab. 10.2*

Mineralogical Group Mineraloška skupina	Late Antique 1 Pozna antika 1	Late Antique 1/2 pozna antika 1/2	Late Antique 2 Pozna antika 2	Early Medieval Zgodnji srednji vek
TG - A	TG - 14 (XIII)	TG - 18 (XIII)	TG - 15 (XIII)	
TG - B		TG - 21 (VI) TG - 16 (IX)		TG - 11 (IX) TG - 17 (X)
TG - C				TG - 12 (X) TG - 13 (X)
TG - D1	TG - 23 (II)	TG - 1 (II)	TG - 2 (II)	
TG - D2	TG - 7 (VI) TG - 19 (VIII)		TG - 9 (VIII) TG - 8 (VIII)	TG - 20 (V) TG - 10 (IX)
TG - D3		TG - 22 (III)	TG - 6 (VI) TG - 3 (III) TG - 4 (III)	TG - 5 (V)

*Table 10.2* also indicates similarities and differences when comparing the macroscopic and microscopic groupings. In some cases (e.g. Groups II and XIII), the macroscopic categories also proved to be mineralogically distinct groups; in others, groups that were distinguished macroscopically (e.g. Groups V and VIII) proved to be mineralogically indistinguishable. Moreover, in several cases (e.g. Group III and X) ceramics that were grouped together macroscopically proved to be of different mineralogical composition. This should not be regarded as a criticism of either methodology, but highlights the importance of using an integrated approach to exploring mineralogical composition of pottery. While macroscopic analysis is the most cost-efficient and inexpensive way to examine the composition of a large volume of ceramic samples, petrographic analyses are also necessary for identifying mineralogical differences not apparent in hand sample.

## 10.5 TECHNOLOGICAL CHOICES

In addition to creating ceramic typologies based on mineralogical composition, petrographic analysis can also potentially reveal different technological choices made during the production sequence (*chaîne opératoire*) of the pottery<sup>6</sup>. For example, the matrix can indicate the basic character of the different clay sources used. The abundance and character of non-plastic inclusions can potentially provide evidence of formation method, tempering, and firing temperature. Voids can also provide information about forming method and fir-

je, da bi lahko odražale tehnološke spremembe v procesu izdelave. Zato je bila mineraloška skupina TG-D na osnovi barve zmesi, ki je posledica temperature in atmosfere žganja (*tab. 10.2*), nadalje razdeljena na tri podskupine.

Petrografske analize so potrdile osnovne zaključke makroskopske analize: med obravnavanimi fazami ob-

staja visoka stopnja kontinuitete pri izdelavi keramike. Petrografski skupini TG-D in TG-B, ki predstavljata 78 % vzorca, vsebujeta približno enako število keramike iz različnih faz, kar kaže na kontinuiteto iz pozne antike v zgodnji srednji vek. Določena stopnja diskontinuitete je morda opazna pri skupini TG-A, ki vsebuje samo keramiko iz pozne antike, in TG-C, ki vsebuje zgodnje-srednjeveško keramiko, čeprav je pri tem treba opozoriti na majhen vzorec. V *tabeli 10.2* so vzorci razdeljeni po mineraloških skupinah in kronološko. Pri tem se rimske številke nanašajo na makroskopsko določeno skupino vsakega vzorca.

*Tabela 10.2* prikazuje tudi podobnosti in razlike med makroskopskim in mikroskopskim razvrščanjem. V nekaterih primerih (npr. skupini II in XIII) makroskopsko določene skupine ustrezajo mikroskopskim; nekatere skupine, ki so bile določene makroskopsko (npr. V in VIII), se mikroskopsko ne razlikujejo med seboj. Še več, v nekaterih primerih (skupini III in X) ima keramika, ki je bila makroskopsko uvrščena v isto skupino, različno mineraloško strukturo. To ni kritika metode, ampak opozorilo na potrebo po integriranem pristopu k raziskavam mineraloških značilnosti keramike. Medtem ko makroskopske analize predstavljajo cenovno najbolj ugoden način za analizo velike količine keramičnih vzorcev, so petrografske analize prav tako potrebne za identifikacijo mineraloških značilnosti, ki drugače niso vidne.

## 10.5 TEHNOLOŠKE IZBIRE

Petrografske analize lahko v povezavi s tipologijo keramike na osnovi mineraloške sestave potencialno

<sup>6</sup> Rye 1981, Herold 2009

ing temperature. However, since the ceramic production sequence has a palimpsesting effect on the final compositional character of the ceramic fabric, it is not always possible to identify each particular technological choice. Yet even tentative results are important, as they provide information that cannot be otherwise determined by the decorative or formal aspects of the pottery.

Group TG-D seems to represent the most common ceramic technological tradition at the site through each phase. These samples contained both quartz and carbonates. Although at this point it is not possible to conclusively assess whether these non-plastic inclusions were naturally present in the clay or later added as temper<sup>7</sup>, some tentative observations can be made. Most of the samples contained roughly the same proportion of carbonates (20-30 %), typically a mixture of angular and rounded inclusions; there is no direct evidence to suggest that these were added as temper, although this possibility cannot be ruled out. The one exception might be TG-C, which had a distinctly higher proportion of coarse quartz, perhaps indicating the addition of sand as a tempering agent.

Overall, the void shape and orientation in the vast majority of samples appear to be the result of drying cracks, which indicates that the ceramics were turned on a wheel. The mineralogy also provides a few hints about firing temperature. It has been experimentally demonstrated that carbonates begin to disintegrate around 800 °C, depending on the duration and intensity of the firing conditions<sup>8</sup>. The shape of the voids in group TG-C, along with a conspicuous absence of carbonates, suggest that carbonates were burned out during the firing process, indicating a higher firing temperature than the other groups. A variety of the different paste colors also provide some indication of the firing environment in each of the different groups, summarized in the following table 10.3<sup>9</sup>.

Tab. 10.3

	<b>Firing Environment</b> <b>Žganje</b>	<b>Paste Color</b> <b>Barva zmesi</b>	<b>Group</b> <b>Skupina</b>
1	Atmosphere oxidizing, organic material absent Oksidacijska atmosfera, brez organskih sestavin	Cross-section of uniform color of fired clay Presek: enotna barva žgane glin	TG - D1
2	Atmosphere oxidizing, organic material present Oksidacijska atmosfera, z organskimi sestavinami	Gray or black core, distinct from color of surface Sivo ali črno jedro, drugačno od barve površine	TG - D3
3	Atmosphere reducing or neutral, organic material absent / Redukcijska ali nevtralna atmosfera, brez organskih sestavin	Gray or black throughout, diffuse or absent core Siva ali črna; jedro razpršeno ali ga ni	TG - B, TG - C
4	Atmosphere reducing or neutral, organic material present / Redukcijska ali nevtralna atmosfera, z organskimi sestavinami	Grey or black throughout Siva ali črna	TG - A, TG - D2

<sup>7</sup> Future analyses will include some samples from the local geology to better determine the nature of these non-plastic inclusions.

<sup>8</sup> Dell'Mour 2001, 191.

<sup>9</sup> Based on Rye 1981.

razkrijejo različne tehnološke izbire, narejene v procesu proizvodnje (*chaîne opératoire*).<sup>6</sup> Matrika, na primer, lahko pokaže osnovne značilnosti različnih virov uporabljene glin. Pogostost in lastnost neplastičnih dodatkov lahko potencialno priskrbi dokaze o načinu sestave in temperaturi žganja. Podatke o sestavi in temperaturi žganja lahko dajo tudi pore. Ker pa ima zaporedje keramične proizvodnje palimpsestni vpliv na končne značilnosti fature keramike, ni vedno mogoče rekonstruirati vsake posamezne tehnološke izbire. Vseeno pa so pomembni že poskusni rezultati, saj priskrbijo podatke, ki jih ni mogoče pridobiti npr. z analizo oblike ali okrasa.

Skupina TG-D očitno predstavlja najpogostejšo tehnološko tradicijo v proizvodnji keramike na najdišču skozi vse faze. Vzorci te skupine vsebujejo kremen in karbonate. Čeprav na tej točki ni mogoče z gotovostjo trditi, ali so ti neplastični vključki naravno prisotni v glini ali dodani kasneje,<sup>7</sup> je že mogoče podati nekaj poskusnih zaključkov. Večina vzorcev vsebuje približno enak odstotek karbonatov (20-30 %), značilna je mešanica oglatih in zaobljenih vključkov; o tem, ali pomenijo dodatek glini, zaenkrat ni dokaza, čeprav te možnosti ne moremo izključiti. Edina izjema bi lahko bila skupina TG-C, ki vsebuje opazno višji odstotek grobega kremen, kar verjetno kaže na dodajanje peska kot pustila.

Oblika in usmeritev por v veliki večini vzorcev je verjetno rezultat razpok pri sušenju, kar kaže, da je bila keramika izdelana na lončarskem vretenu. Mineralogija je dala tudi nekaj podatkov o temperaturi žganja. S poskusi je bilo dokazano, da karbonati začnejo razpadati pri pribl. 800 °C, odvisno od dolžine in intenzivnosti žgalnih pogojev.<sup>8</sup> Oblika por v skupini TG-C kaže, skupaj z opazno odsotnostjo karbonatov, da so karbonati zgoreli med procesom žganja, kar nakazuje višjo žgalno temperaturo kot pri ostalih skupinah. Nekaj indicov za pogoje žganja v vsaki od skupin daje tudi raznolikost barv (tab. 10.3).<sup>9</sup>

<sup>6</sup> Rye 1981, Herold 2009.

<sup>7</sup> Za boljšo določitev teh neplastičnih vključkov bodo bodoče analize vključile nekaj primerov lokalnih geoloških vzorcev.

<sup>8</sup> Dell'Mour 2001, 191.

<sup>9</sup> Nas podlagi Rye 1981.

## 10.6 CONCLUSIONS

The petrographic analyses of the coarse-ware ceramics at Tonovcov grad have provided some indication of the degree of technological continuity between the Late Antique and Early Medieval occupations of the site, as well as given insight into technological choices made during the production of pottery at the site. The results of this analysis are admittedly preliminary, and future research with larger sample sizes and a greater variety of analyses will hopefully provide additional information on this particular aspect of the settlement.

## PETROGRAPHIC FABRIC DESCRIPTIONS

## GROUP TG-A

*Samples: (Tab. 10.4)*

Tab. 10.4

Sherd # Št. odlomka	Phase Faza	Macroscopic Fabric Group Makroskopska fakturna skupina	Provenance Izvor
21168	LA / PA 1	13	Building 1, SU 68
21137	LA / PA 1/2	13	Building 1, SU 21
20533	LA / PA 2	13	Building 1, SU 29

*Macroscopic description:* Porous fired-clay body with numerous white inclusions (various sizes); Munsell: black core, black surface.

*Petrographic description:* Fired-clay matrix, with trace to no quartz inclusions, mostly coarse<sup>10</sup>, well sorted, and rounded; 20-25 % carbonate<sup>11</sup> inclusions of both sparry and micritic character, partially disintegrating into lime mud, well sorted, rounded to sub-angular, which run up to c. 2.0 mm in length; 0-1 % small fibrous muscovite mica; 3-5 % black opaques; and 5-10 % thin, elongated voids that run E-W (drying cracks).

*Distinction:* This fabric is most easily identifiable by the very low (or completely absent) quartz component, which distinguishes it from all other fabric groups at Tonovcov grad.

*Micrograph*<sup>12</sup>: (Fig. 10.2)

## GROUP TG-B

*Samples: (Tab. 10.5)*

<sup>10</sup> Quartz inclusions have been simply divided between 'fine' and 'coarse', with the former being smaller than 0.25 mm and the latter being larger.

<sup>11</sup> Some of the samples were stained in order to distinguish different carbonates, and all appear to be calcite.

<sup>12</sup> A note about scale: the approximate diameter of the field of view in the microphotographs is 4.25 mm

## 10.6 SKLEPI

Petrografska analiza grobe keramike s Tonovcovega gradu je dala nekaj podatkov o stopnji tehnološke kontinuitete med poznoantično in zgodnjesevrednjeveško poselitvijo naselbine, pa tudi vpogled v tehnološke odločitve v procesu proizvodnje keramike. Rezultati so preliminarni, prihodnje raziskave na večjih vzorcih in z večjo raznolikostjo analiz bodo, upajmo, dale dodatne informacije o naselbini tudi s tega vidika.

## OPIS FAKTUR

## SKUPINA TG-A

*Vzorci: (tab. 10.4)*

*Makroskopski opis:* Porozna glina s številnimi belimi vključki (različne velikosti); Munsell: črno jedro, črna površina

*Petrografski opis:* Matrika z malo ali brez kremenovih vključkov, večinoma grobih,<sup>10</sup> pravilno razporejenih, zaokroženih; 20-25 % karbonatnih<sup>11</sup> vključkov, tako sparitnega kot mikritnega značaja, delno razkrojenih v apnenčev mulj, pravilno razporejenih, okroglih do nepopolno oglatih, dolgih do 0,2 mm; 0-1 % drobne vlaknaste muskovitne sljude; 3-5 % črnih neprozornih delcev; 5-10 % tankih podolgovatih delcev usmerjenih V-Z (razpoke pri sušenju).

*Razlikovanje:* Zelo nizka vrednost ali popolna odsotnost kremenca razlikuje skupino od vseh ostalih skupin na Tonovcovem gradu.

*Mikrografija*<sup>12</sup>: (sl 10.2)

## SKUPINA TG - B

*Vzorci: (tab. 10.5)*

*Makroskopski opis:* Porozno žgana glina, nekateri vzorci z zmerno količino belih vključkov; Munsell: rjavo,

<sup>10</sup> Kremenovi vključki se preprosto delijo med "fine" in "grobe" tako, da so prvi manjši od 0.25 mm in drugi večji.

<sup>11</sup> Barvanje vzorcev z namenom razlikovanja različnih karbonatov je pokazalo, da so bili vsi kalciti.

<sup>12</sup> Opomba o merilu: povprečni premer polja na mikrografijah je 4,25 mm.



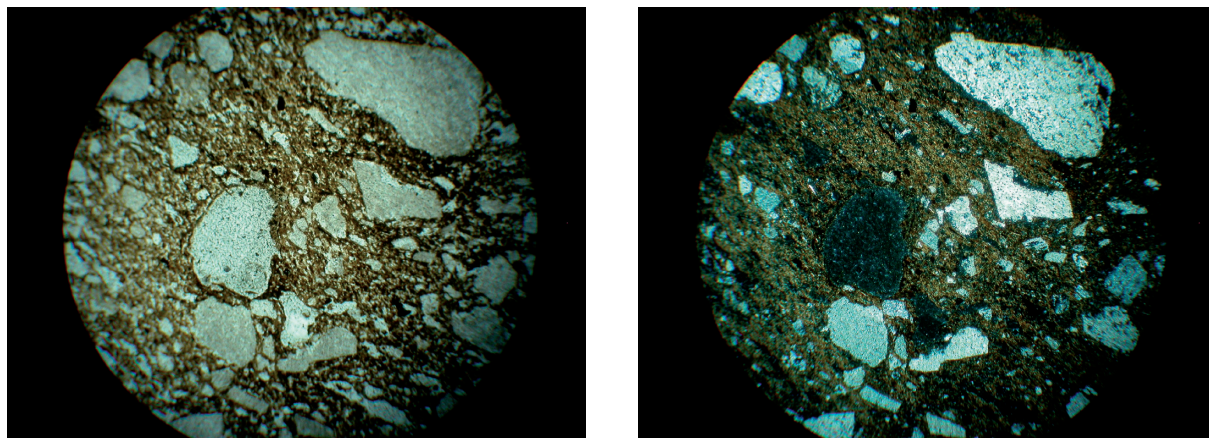

Fig. 10.2: Example of Group TG–A in Thin Section (Sample TG–14); Plane Polarized Light on Left, Cross-Polarized Light on Right  
Sl. 10.2: Primeri zbruskov skupine TG–A (vzorec TG 14); polarizirana svetloba na levi, z vključenim analizatorjem na desni.

Tab. 10.5

Sherd # Št. odlomka	Phase Faza	Macroscopic Fabric Group Makroskopska fakturna skupina	Provenance Izvor
20970	LA / PA 1/2	6	Building 1, SU 24
21262	LA / PA 1/2	9	Building 1, SU 63
20184	EM /ZSV	9	Building 1, SU 10
20063	EM /ZSV	10	Building 1, SU 9

*Macroscopic description:* Porous fired-clay body, some with moderate white inclusions. Munsell: brown, reddish brown, or pale brown core; brown, reddish brown, very dark grey brown, and black surface.

*Petrographic description:* Fired-clay matrix, with 2-5 % quartz inclusions, mixture coarse and fine, well sorted and well-rounded to sub-rounded; 0-5 % rounded carbonate inclusions, which run up to 2.0 mm in length; 0-2 % small fibrous muscovite mica; 10-20 % large and circular and irregularly shaped voids.

*Distinction:* This fabric is distinguished from the other groups by the complete or partial burning out of carbonate inclusions during the firing process (as evidenced by the shape of the voids).

*Micrograph:* (Fig. 10.3)

rdečkasto rjavo ali svetlo rjavo jedro; rjava, rdečkasto rjava, zelo temno sivo rjava in črna površina.

*Petrografski opis:* Matrika iz žgane gline, z 2–5 % kremenovih vključkov (mešanica grobih in finih); pravilno razporejeni, dobro zaokroženi do nepopolno zaokroženi; 0–5 % okroglih karbonatnih vključkov, dolgih do 2,0 mm; 0–2 % drobne vlaknaste muskovitne sljude; 10–20 % velikih, krožno in nepravilno oblikovanih por.

*Razlikovanje:* Od ostalih fakturnih skupin se razlikuje po popolni ali delni izgorelosti karbonatnih vključkov v procesu žganja, kar dokazuje oblika por.

*Mikrografija:* (sl. 10.3)

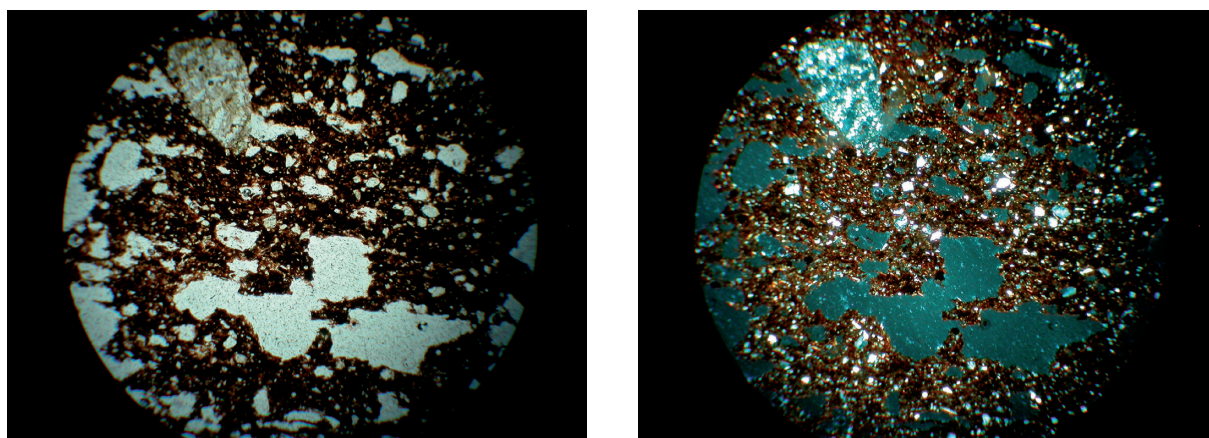

Fig. 10.3: Example of Group TG–B in Thin Section (Sample TG–16); Plane Polarized Light on Left, Cross Polarized Light on Right  
Sl. 10.3: Primeri zbruskov skupine TG–B (vzorec TG 16); polarizirana svetloba na levi, z vključenim analizatorjem na desni.

## GROUP TG-C

## SKUPINA TG-C

Samples: (Tab. 10.6)

Vzorci: (tab. 10.6)

Tab. 10.6

Sherd # Št. odlomka	Phase Faza	Fabric Group Fakturna skupina	Provenance Izvor
05/3/2	EM / ZSV	10	Building 5 (Water Cistern), SU 44
20020	EM / ZSV	10	Building 1, SU 9

*Macroscopic Description:* Porous fired-clay body with numerous white inclusions; Munsell: brown core, yellowish red surface.

*Petrographic description:* Fired-clay matrix, with 8 % quartz inclusions, mostly coarse, moderately sorted and well rounded to sub-rounded; 20 % rounded carbonates, micritic, and partially disintegrating into lime mud, poorly to moderately sorted, and rounded to sub-angular, up to c. 1.5 mm in length; trace to 2 % fine and fibrous muscovite mica; 2 % hematite inclusions; 10 % large and irregularly shaped voids.

*Distinction:* This fabric is distinguished from others at Tonovcov grad by a relatively high level of quartz inclusions.

*Micrograph:* (Fig. 10.4)

*Makroskopski opis:* Porozno žgana glina s številnimi belimi vključki; Munsell: rjavo jedro, rumenkasto rdeča površina.

*Petrografski opis:* Matrika iz žgane gline, 8 % kremenovih vključkov, večinoma grobih, zmerno razporejenih, dobro do nepopolno zaokroženih; 20 % karbonatov, mikritnih in delno razkrojenih v apnenčev mulj, slabo do zmerno razporejenih, zaokroženih do delno oglatih, dolgih do pribl. 1.5 mm; drobna vlaknasta muskovitna sljuda v sledovih do 2 %; 2 % hematitnih vključkov; 10 % velikih in nepravilno oblikovanih por.

*Razlikovanje:* Od ostalih se razlikuje po relativno veliki količini kremenovih vključkov.

*Mikrografija:* (sl. 10.4)

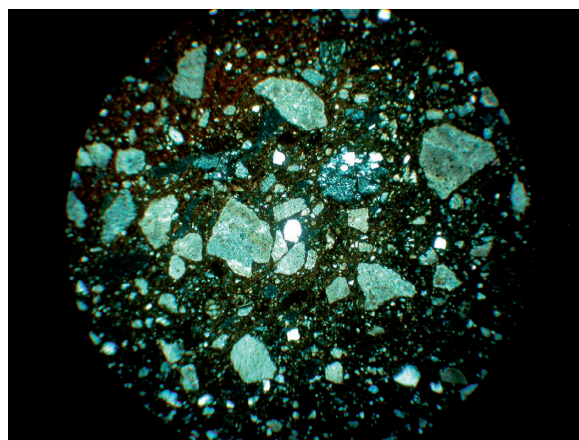
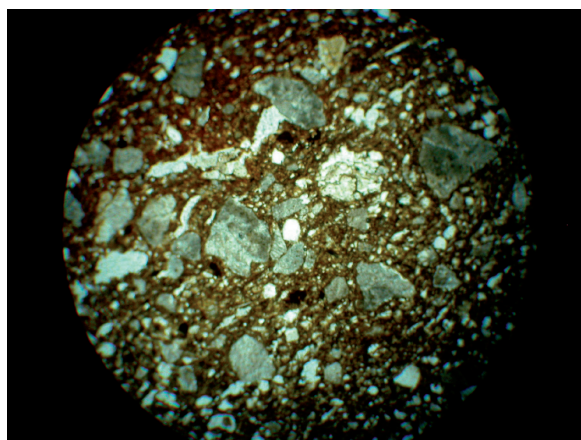

Fig. 10.4: Example of Group TG-C in Thin Section (Sample TG-12); Plane Polarized Light on Left, Cross Polarized Light on Right  
Sl. 10.4: Primeri zbruskov skupine TG-C (vzorec TG 12); polarizirana svetloba na levi, z vključenim analizatorjem na desni

## GROUP TG-D1

## SKUPINA TG-D1

Samples: (Tab. 10.7)

Vzorci: (tab. 10.7)

Tab. 10.7

Sherd # Št. odlomka	Phase Faza	Fabric Group Fakturna skupina	Provenance Izvor
20947	LA / PA 1	2	Building 1, SU 30
20906	LA / PA 1/2	2	Building 1, SU 24
20409	LA / PA 2	2	Building 1, SU 29

*Macroscopic description:* Slightly porous fired-clay body with numerous white inclusions (varied sizes); Munsell: pink to light brown core, pink to light brown surface.

*Petrographic description:* Fired-clay matrix, with 3-5 % quartz inclusions, mostly fine, very well to moderately sorted and well rounded to sub-rounded; 15-20 % carbonates, well to poorly sorted, mostly micritic (showing mosaic extinction), rounded to well rounded, partially disintegrating into lime mud, and up to c. 2.0 mm in length; trace to 1 % fine and fibrous muscovite mica; 5-10 % voids, shaped like drying cracks.

*Distinction:* Group TG-D is the most common fabric type at in the sample with moderate levels of quartz and carbonate, and low mica. D1 is distinguished from the other D groups primarily by the fabric color (light red to pink), which indicates firing in an oxidizing atmosphere without organic material.

*Micrograph:* (Fig. 10.5)

*Makroskopski opis:* Rahlo porozno žgana glina s številnimi belimi vključki (različne velikosti); Munsell: rožnato do svetlo rjavo jedro, rožnata do svetlo rjava površina.

*Petrografski opis:* Matrika iz žgane gline, s 3–5 % kremenovih vključkov, večinoma drobnih, zelo dobro do zmerno razporejenih, zaokroženih do nepopolno zaokroženih; 15–20 % karbonatov, dobro do slabo razporejenih, večinoma drobnozrnatih (kažejo mozaično potemnitev), zaokroženih do dobro zaokroženih, delno razpadlih v apnenčev mulj, dolgih do pribl. 2,0 mm; drobna vlaknasta muskovitna sljuda v sledovih do 1 %; 5–10 % por v obliki razpok pri sušenju.

*Razlikovanje:* Skupina TG–D je najbolj pogost faktorni tip z zmerno ravno kremena in karbonatov ter nizko ravno sljude. D1 se od ostale skupine D razlikuje predvsem po barvi fature (svetlo rdeča do rožnata), ki kaže na žganje v oksidacijski atmosferi brez organskih snovi.

*Mikrografija:* (sl. 10.5)

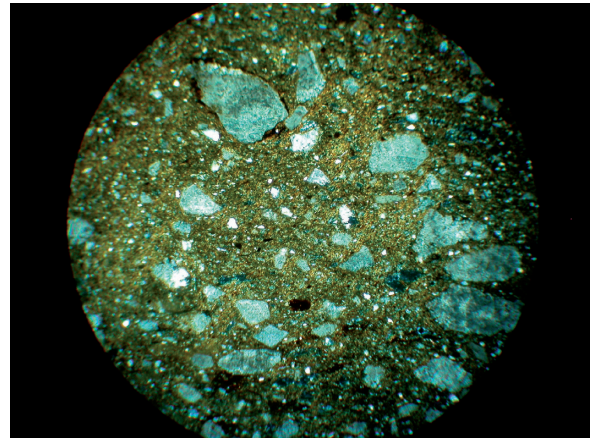
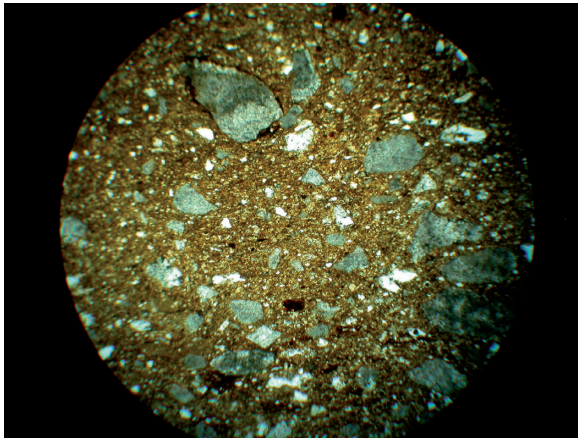

Fig. 10.5: Example of Group TG–D1 in Thin Section (Sample TG–1); Plane Polarized Light on Left, Cross Polarized Light on Right  
Sl. 10.5: Primeri zbruskov skupine TG–D1 (vzorec TG 1); polarizirana svetloba na levi, z vključenim analizatorjem na desni

#### GROUP TG-D2

*Samples:* (Tab. 10.8)

#### SKUPINA TG-D2

*Vzorci:* (tab. 10.8)

Tab. 10.8

Sherd # Št. odlomka	Phase Faza	Fabric Group Fakturna skupina	Provenance Izvor
21415	LA / PA 1	8	Building 1, SU 30
21705	LA / PA 1	6	Building 1, SU 29a
20540	LA / PA 2	8	Building 1, SU 23
21994	LA / PA 2	8	Building 1 <sup>1</sup>
20365	EM / ZSV	5	Building 1, SU 10
05/3	EM / ZSV	9	Building 5 (Water Cistern), SU 44

*Macroscopic description:* Slightly porous fired-clay body with white inclusions (varied sizes); Munsell: very dark grey brown to dark grey to brown core, similar color on surfaces.

*Makroskopski opis:* Rahlo porozno žgana glina z belimi vključki (različne velikosti); Munsell: zelo temno sivo rjavo do temno sivo do rjavo jedro, podobna barva na površini.

*Petrographic description:* Fired-clay matrix, with 2-6 % quartz inclusions, mixture coarse and fine, moderate to well sorted, and well rounded to sub-rounded; 20-25 % carbonates, poorly sorted, well rounded to sub-angular, mostly of micritic or mixed character, most partially or fully disintegrating into lime mud, up to 2.0 mm in length; trace to 2 % fine and fibrous muscovite mica; trace plagioclase feldspar in some; 2 % black or reddish opaques (hematite) in some; 5-15 % voids, mostly oriented E/W like drying cracks.

*Distinction:* Same as other TG-D groups, but uniform dark grey to brown fabric color, suggesting a reducing or neutral firing atmosphere with organic material present.

*Micrograph:* (Fig. 10.6)

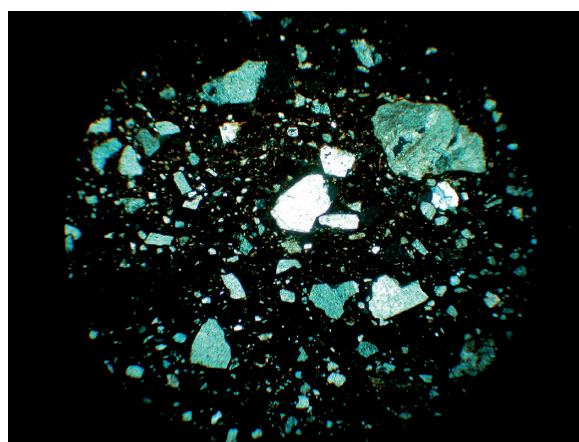
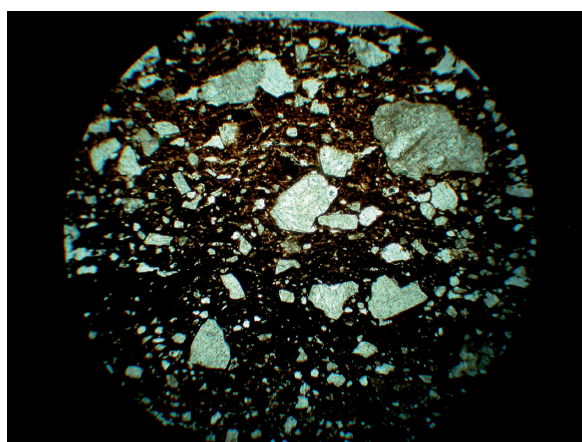

Fig. 10.6: Example of Group TG-D2 in Thin Section (Sample TG-10); Plane Polarized Light on Left, Cross Polarized Light on Right  
Sl. 10.6: Primeri zbruskov skupine TG-D2 (vzorec TG 10); polarizirana svetloba na levi, z vključenim analizatorjem na desni.

### GROUP TG-D3

*Samples:* (Tab. 10.9)

### SKUPINA TG-D3

*Vzorci:* (tab. 10.9)

Tab. 10.9

Sherd # Št. odlomka	Phase Faza	Fabric Group Fakturna skupina	Provenance Izvor
21344	LA / PA 2	6	Building 1, SU 23
20312	LA / PA 1/2	3	Building 1, SU 21
20438	LA / PA 2	3	Building 1, SU 11
20195	EM / ZSV	5	Building 1, SU 10
20438	LA / PA 2	3	Building 1, SU 11

*Macroscopic description:* Slightly porous fired-clay body with numerous white inclusions (varied sizes); Munsell: dark grey to brown core, various color surfaces (strong brown, yellowish red, dark grey, light red).

*Petrographic description:* Fired-clay matrix, with 4-6 % quartz inclusions, mixture coarse and fine, well

*Makroskopski opis:* Rahlo porozno žgana glina s številnimi belimi vključki (različne velikosti); Munsell: temno sivo do rjavo jedro, različne barve površine (močno rjava, rumenkasto rdeča, temno siva, svetlo rdeča).

*Petrografski opis:* Matrika iz žgane gline, s 4-6 % kremenovih vključkov, mešanica grobih in finih, dobro

sorted, well rounded to sub-rounded; 20-30 % carbonates, poorly to well sorted, well rounded to sub-angular, mostly micritic and disintegrating into lime mud; 1-2 % fine muscovite mica; trace plagioclase feldspar in some; 10-15 % voids, mostly oriented E/W like drying cracks.

*Distinction:* Same mineralogical content as TG-D1 and TG-D2, but different colors between core and surface reveal a different kind of firing atmosphere (oxidizing atmosphere with organic material present).

*Micrograph:* (Fig. 10.7)

razporejenih, okroglih do nepopolno okroglih; 20–30 % karbonatov, slabo do dobro razporejenih, okroglih do delno oglatih, večinoma mikritnih in razpadljivih v apne-no blato; 1–2 % drobne vlaknaste muskovitne sljude; v nekaterih sledovi plagioklaznih glincev; 10–15 % por, večinoma orientiranih V–Z kot razpoke pri sušenju.

*Razlikovanje:* Enaka mineraloška vsebina kot TG–D1 and TG–D2, vendar različne barve med jedrom in površino kažejo na drugačen tip žgalne atmosfere (oksidacijska s prisotnostjo organskega materjala).

*Micrografija:* (sl. 10.7)

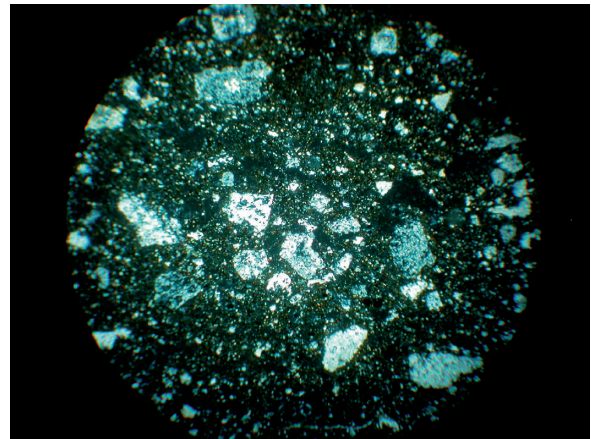
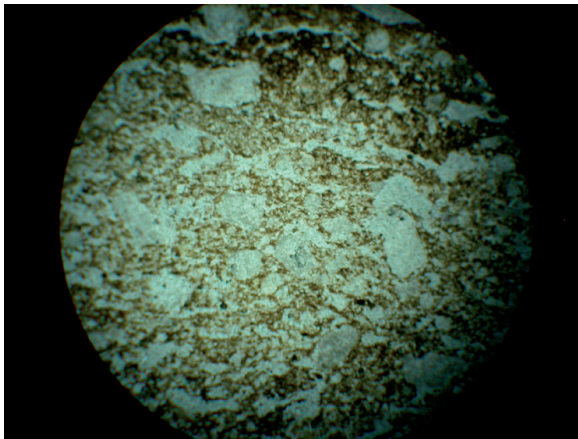

Fig. 10.7: Example of Group TG–D3 in Thin Section (Sample TG–4); Plane Polarized Light on Left, Cross Polarized Light on Right  
Sl. 10.7: Primeri zbruskov skupine TG–D3 (vzorec TG 4); polarizirana svetloba na levi, z vključenim analizatorjem na desni.

## 10.7 BIBLIOGRAPHY / LITERATURA

Tonovcov grad. Settlement remains and interpretation / Tonovcov grad. Naselbinski ostanki in interpretacija = Ciglenečki, Modrijan, Milavec 2011.

CIGLENEČKI, S., Z. MODRIJAN and / in T. MILAVEC 2011, *Tonovcov grad. Naselbinski ostanki in interpretacija / Tonovcov grad. Settlement remains and interpretation.* – Opera Instituti Archaeologici 23.

DELL'MOUR, R. 2001, Mikroskopische Untersuchungen an frühmittelalterlichen Keramik von Thunau am Kamp, NÖ. Lokaleware-Importe-Rohstoffherkunft. – *Anzeiger der philosophische-historischen Klasse* 136, 69–109.

HEROLD, H. Materielle Kultur – Technologische Traditionen – Identität: Untersuchungen zur Archäologie des Frühmittelalters in Niederösterreich. – *Zeitschrift für Archäologie des Mittelalters* 37, 111–34.

KERR, P. 1977, *Optical mineralogy* (4<sup>th</sup> edition). – New York.

MASON, R. 2004, *Shine like the sun: lustre-painted and associated pottery from the medieval Middle East.* – Costa Mesa, California.

MODRIJAN, Z. 2008, *Poznoantična groba kuhinjska keramika ter uvoženo posodje z območja Slovenije in Furlanije.* (Unpublished doctoral thesis / Neobjavljena doktorska disertacija) – Ljubljana.

RYE, O. 1981, *Pottery technology: principles and reconstruction.* – Washington, D.C.

STOLTMAN, J. 1989, A Quantitative Approach to the Petrographic Analysis of Ceramic Thin Sections. – *American Antiquity* 54, 147–60.

TERRY, R. and / in CHILINGAR, G. 1955, Summary of "Concerning some additional aids in studying sedimentary formations," by M. S. Shvetsov. – *Journal of Sedimentary Research* 25, 229–34.

WHITBREAD, I. 1995, *Greek transport amphorae: A petrological and archaeological study.* – Oakville, CT.



# 11. KATALOG

## 11. CATALOGUE

Zvezdana MODRIJAN, Tina MILAVEC

V katalogu so zbrane kovinske, rogovinaste, steklene in keramične najdbe.

Opisi kovinskih predmetov:

Vrsta najdbe; material; mere. Stavba, kvadrant/mikrokvadrant, stratigrafska enota (SE). Inventarna številka. Objave.

Opisi steklenih predmetov:

Vrsta najdbe; material; barva. Stavba, kvadrant/mikrokvadrant, stratigrafska enota (SE). Inventarna številka. Objave.

Opisi keramičnih vretenc:

Vrsta najdbe; material; barva; primesi. Stavba, kvadrant/mikrokvadrant, stratigrafska enota (SE). Inventarna številka.

Opisi keramičnih posod (glej tudi pogl. 4.2.1):

Vrsta najdbe; material; ohranjenost; barva; primesi (vrsta, pogostost); površina; tehnološka skupina (TS); okras. Stavba, kvadrant/mikrokvadrant, stratigrafska enota (SE). Inventarna številka. Objave.

Nekatere najdbe so že bile objavljene, literatura za navedene citate se nahaja v pripadajočih poglavjih obravnave gradiva.

Za preglednici stratigrafskih enot po fazah glej poglavje 1, *tab. 1.1* in *1.2*.

K posameznim skupinam najdb v stavbi 1 so dodane tudi nekatere detektorske najdbe, za katere natančni najdiščni podatki niso znani.

Okrajšave:

d. – dolžina ; š. - širina; v. - višina; db. - debelina;  
pr. – premer; m. – masa

Najdbe hrani Tolminski muzej.

In the catalogue metal, antler, glass and pottery finds are assembled.

Metal finds:

Find type; material; measurements. Structure, quadrant/microquadrant, stratigraphic unit (SU). Inventory number. Previous publications.

Glass finds:

Find type; material; colour. Structure, quadrant/microquadrant, stratigraphic unit (SU). Inventory number. Previous publications.

Pottery spindle whorls:

Find type; material; colour; inclusions. Structure, quadrant/microquadrant, stratigraphic unit (SU). Inventory number.

Pottery vessels (see also chapter 4.2.1):

Find type; material; state of preservation; colour; inclusions (type, frequency); surface; technological group (TG); decoration. Structure, quadrant/microquadrant, stratigraphic unit (SU). Inventory number. Previous publications.

Some finds have already been published. The publications references can be found in the chapters where these finds are discussed.

For the tables of stratigraphic units see chapter 1, *Tab. 1.1* and *1.2*.

To categories of finds in building 1 certain metal detector finds, for which the exact find spot is unknown, were added.

Abbreviations:

d. – length ; š. – width; v. – height; db. – thickness;  
pr. – diameter; m. – weight

The finds are kept by the Tolminski muzej in Tolmin.

Tabla 1

1. Fibula; bron; d. 5,2 cm. Stavba 1, kv. 616/A4, SE 34. Inv. št. 22478.  
– Ciglenečki 1994b, t. 1: 6.
2. Fibula; bron; d. 5,3 cm. Stavba 1, sečišče kv. 468, 469, 509, 510. Inv. št. 22877.  
– Milavec, Modrijan 2007, sl. 5: 2.
3. Fibula; bron; d. 5 cm. Stavba 1, kv. 669/C1, SE 30. Inv. št. 22209.  
– Cunja, Mlinar 2010, 119, kat. 154.
4. Fibula; bron; d. 4 cm. Stavba 1. Inv. št. 23098.  
– Ciglenečki 1994a, t. 6: 1; 1994b, t. 1: 3.
5. Fibula; bron; d. 2,2 cm. Stavba 1, kv. 619/B2, SE 34. Inv. št. 22482.
6. Fibula; bron; d. 5,9 cm. Stavba 1, kv. 592/B4, SE 06. Inv. št. 22872.
7. Fibula; bron; d. 3 cm. Stavba 1, kv. 716/B4, SE 23. Inv. št. 22477.
8. Fibula; bron; d. 5 cm. Stavba 1, kv. 717/B2. Inv. št. 22881.
9. Fibula; bron; d. 3,2 cm. Stavba 1, kv. 766/A1, SE 01. Inv. št. 22874.
10. Fibula; bron; d. pribl. 6 cm. Stavba 1, kv. 719/D2, SE 26. Inv. št. 22476.
11. Fibula; bron; d. 4,5 cm. Stavba 1, kv. 719/C1, SE 26. Inv. št. 22873.
12. Fibula; bron; d. 7 cm. Stavba 1, kv. 666/A1, SE 29. Inv. št. 22457.
13. Fibula; bron. Stavba 1, kv. 664/D4, SE 26. Inv. št. 24139.
14. Fibula; bron; d. 2,7 cm. Stavba 1, kv. 816/D1, SE 34. Inv. št. 22435.
15. Fibula; bron; d. 2,3 cm. Stavba 1, kv. 716/B4, SE 01. Inv. št. 22879.
16. Fibula; bron. Stavba 1. Detektorska najdba. Založena.  
– Ciglenečki 1994a, t. 6: 2; 1994b, t. 1: 5.
17. Fibula; bron. Stavba 1. Detektorska najdba. Založena.  
– Ciglenečki 1994b, t. 1: 4.
18. Fibula; bron; d. 4,5 cm. Stavba 1. Inv. št. 23099.  
– Ciglenečki 1994b, t. 1: 7; 1994c, t. 1: 1; 1997a, 30.
19. Fibula; bron; d. 4,5 cm. Stavba 1, kv. 668/B3. Inv. št. 23124.
20. Fibula; bron; d. 3,5 cm. Stavba 1, kv. 766/B3. Inv. št. 22455.

Tabla 2

1. Fibula; bron; pr. 2,9 cm. Stavba 1, kv. 668/B1, SE 26. Inv. št. 22200.  
– Ciglenečki 1997b, 20; 2008, sl. 18: 6.
2. Fibula; železo; pr. 3,2 cm. Stavba 1, kv. 716/B3, SE 24. Inv. št. 22324.  
– Ciglenečki 2008, sl. 18: 7.
3. Fibula; železo; pr. 3,8 cm. Stavba 1, kv. 768/C3, del D3, SE 03. Inv. št. 23269.
4. Fibula; železo; pr. 3,5 cm. Stavba 1, kv. 718/C2, SE 10. Inv. št. 22827.
5. Fibula; bron; d. 3,9 cm. Stavba 1, kv. 817/D3, SE 03. Inv. št. 23100.  
– Ciglenečki 1994a, t. 6: 3; 1994b, t. 1: 8; 1997a, 30; Cunja, Mlinar 2010, 122, kat. 174.

6. Fibula; bron; d. 3,2 cm. Stavba 1, kv. 817/D2, SE 03. Inv. št. 22869.  
– Milavec, Modrijan 2007, sl. 5: 4.
7. Fibula; bron; d. 3,5 cm. Stavba 1. Detektorska najdba. Inv. št. 23102.  
– Ciglenečki 1994a, t. 6: 4; 1994b, t. 1: 9; 2008, sl. 18: 5.
8. Čebulast gumb fibule; bron; pr. 1,1 cm. Stavba 1, kv. 818/A2, SE 06. Inv. št. 22777.
9. Noga fibule; bron; d. 2,2 cm. Stavba 1, kv. 766/A3, SE 24. Inv. št. 23765.
10. Fibula; bron; d. 5,5 cm. Stavba 1, kv. 668/D2, SE 31. Inv. št. 22431.  
– Ciglenečki 2008, sl. 18: 1.
11. Fibula; bron; d. 4,5 cm. Stavba 1, kv. 817/D3, SE 03. Inv. št. 22210.  
– Ciglenečki 1997a, 30; 1997b, 20; 2008, sl. 18: 2; Milavec, Modrijan 2007, sl. 5: 6; Cunja, Mlinar 2010, 126, kat. 193.
12. Fibula; bron; d. 5 cm. Stavba 1, kv. 666/A2, A3, B2, B3, SE 34, 29. Inv. št. 22880.
13. Fibula; bron; d. 4,7 cm. Stavba 1. Detektorska najdba. Inv. št. 23101.  
– Ciglenečki 1994a, t. 6: 6; 1994b, t. 1: 11; 1994c, t. 1: 3; 1997b, 20; 2008, sl. 18: 3.
14. Fibula; bron. Stavba 1. Detektorska najdba. Založena.  
– Ciglenečki 1994a, t. 6: 5; 1994b, t. 1: 10; 1994c, t. 1: 2; 2008, sl. 18: 4.
15. Fibula; železo; d. 8,3 cm. Stavba 1, kv. 766/B2, SE 24. Inv. št. 22204.  
– Ciglenečki 2008, sl. 22: 6; Milavec 2009, t. 1: 2.
16. Fibula; železo; d. 7,5 cm. Stavba 1, kv. 666/C1, SE 29. Inv. št. 22213.  
– Ciglenečki 2008, sl. 22: 3; Milavec 2009, t. 1: 3; Cunja, Mlinar 2010, 129, kat. 209.
17. Fibula; železo; d. 5,5 cm. Stavba 1, kv. 669/C1, SE 28. Inv. št. 22203.  
– Ciglenečki 1997b, 21; 2005, sl. 8: 1; 2008, sl. 22: 4; Milavec 2009, t. 1: 10; Cunja, Mlinar 2010, 129, kat. 211.

Tabla 3

1. Fibula; železo; d. 6 cm. Stavba 1, kv. 716/B2, SE 23. Inv. št. 22207.  
– Ciglenečki 2008, sl. 22: 7; Milavec 2009, t. 1: 9.
2. Fibula; železo; d. 6,6 cm. Stavba 1, kv. 718/C2, SE 01. Inv. št. 22211.  
– Milavec, Modrijan 2007, sl. 11: 3; Milavec 2009, t. 1: 4; Modrijan 2011, sl. 2: 1.
3. Fibula; železo; d. 6,8 cm. Stavba 1, kv. 666/B4, SE 06. Inv. št. 22206.  
– Ciglenečki 2008, sl. 22: 5; Milavec 2009, t. 1: 5; Modrijan 2011, sl. 2: 2.
4. Fibula; železo; d. 3,5 cm. Stavba 1, kv. 619/A3, SE 34. Inv. št. 22669.  
– Milavec 2009, t. 2: 2; Modrijan 2011, sl. 2: 3.
5. Fibula; železo; d. 5,3 cm. Stavba 1, kv. 666/B3, SE 50. Inv. št. 22957.  
– Milavec 2009, t. 2: 1; Modrijan 2011, sl. 2: 4.
6. Fibula; železo; d. 3,6 cm. Stavba 1, kv. 619/C2, SE 34. Inv. št. 22208.  
– Milavec 2009, t. 2: 3; Modrijan 2011, sl. 2: 4.



7. Fibula; bron; d. 6 cm. Stavba 1. Detektorska najdba. Inv. št. 23103.

– Ciglenečki 1994a, t. 6: 8; 1994b, t. 1: 13; 1994c, t. 1: 4; 1997b, 21; 1999c, 340; 2005, sl. 8: 2; 2008, sl. 22: 2; Milavec 2009, t. 2: 5; Cunja, Mlinar 2010, 129, kat. 212; Modrijan 2011, sl. 2: 6.

8. Fibula; bron; d. 3,2 cm. Stavba 1. Detektorska najdba. Inv. št. 23104.

– Ciglenečki 1994a, t. 6: 7; 1994b, t. 1: 12; 1997a, 30; 2008, sl. 22: 9; Milavec 2009, t. 2: 6.

9. Fibula; bron; d. 4,2 cm. Stavba 1, kv. 666/A1, SE 29. Inv. št. 22205.

– Ciglenečki 2008, sl. 22: 8; Milavec 2009, t. 2: 7.

10. Fibula; bron; d. pribl. 3,5 cm. Stavba 1, kv. 817/B1, SE 21. Inv. št. 22458.

– Milavec 2009, t. 2: 8.

11. Fibula; železo; d. 2,7 cm. Stavba 1, kv. 815/D1, SE 06. Inv. št. 22290.

– Milavec 2009, t. 2: 9.

12. Peresovina fibule; železo; d. 5,2 cm. Stavba 1, kv. 716/C1, SE 06. Inv. št. 22870.

13. Iгла fibule; železo; d. 3,1 cm. Stavba 1, kv. 666/A3, SE 29. Inv. št. 22436.

14. Fibula; železo; d. 7,5 cm. Stavba 1, kv. 716/A2, SE 23. Inv. št. 23762.

– Milavec 2009, t. 2: 4.

15. Fibula; bron; d. 3,5 cm. Stavba 1, kv. 669, SE 03. Inv. št. 23093.

– Ciglenečki 1997a, 17, 31; 1997b, 21; 1999a, 330; 2005, sl. 8: 5; 2008, sl. 22: 10; Modrijan 2011, sl. 2: 9.

16. Fibula; bron; d. 5,8 cm. Stavba 1, kv. 716/med A1 in B1, SE 06. Inv. št. 23096.

– Ciglenečki 1994c, t. 1: 5; 1997a, 31; 1997b, 21; 1999c, 340; 2005, sl. 8: 3; 2008, sl. 22: 1; Cunja, Mlinar 2010, 130, kat. 217; Modrijan 2011, sl. 2: 8.

#### Tabla 4

1. Fibula; srebro, železo; d. 2,8 cm. Stavba 1, kv. 818/B1, SE 05. Inv. št. 23091.

– Ciglenečki 1997a, 30; Modrijan 2011, sl. 2: 10.

2. Fibula; srebro, železo, kamen ali steklo; pr. 1,6 cm. Stavba 1, kv. 666/C2, SE 29. Inv. št. 23094.

– Ciglenečki 1997a, 17, 30; 1997b, 21; 1999d, 350; 2005, sl. 8: 4; 2008, sl. 22: 11; Modrijan 2011, sl. 2: 11.

3. Sponka verižice; bron; d. 4,7 cm. Stavba 1, kv. 666/A4. Inv. št. 22366.

4. Jagoda, dvodelna; steklena pasta; d. 0,6 cm. Stavba 1, kv. 666/A2, SE 56. Inv. št. 22303, sl. 2.3: 3.

5. Jagoda, obročasta; steklena pasta; db. 0,8 cm. Stavba 1, kv. 717/D4. Inv. št. 22310, sl. 2.3: 4.

6. Jagoda, obročasta; steklena pasta; db. 1 cm. Stavba 1, kv. 719/C2, SE 01. Inv. št. 22309, sl. 2.3: 2.

7. Jagoda, melonasta; steklena pasta; d. 1,7 cm. Stavba 1, kv. 716/B1, SE 06. Inv. št. 22307, sl. 2.3: 5.

8. Jagoda, sodasta; kalcedon; d. 3,8 cm. Stavba 1, kv. 818/A1, SE 05. Inv. št. 22306.

9. Jagoda, valjasta; steklena pasta; d. 1,7 cm. Stavba 1, 716/D4, SE 23. Inv. št. 22308, sl. 2.3: 1.

10. Jagoda, večdelna; steklena pasta; d. 1,9 cm. Stavba 1, kv. 767/A4, SE 10. Inv. št. 22304, sl. 2.3: 7.

11. Jagoda, cevasta; steklena pasta; d. 1,3 cm. Stavba 1, kv. 767, SE 10. Inv. št. 22305, sl. 2.3: 6.

12. Obesek; steklo; v. 2,3 cm. Stavba 1. Slučajna najdba. Inv. št. 23512, sl. 2.3: 8.

13. Obesek; bron; d. 1,9 cm. Stavba 1, kv. 618/C2, SE 06. Inv. št. 22334.

14. Obesek; železo; v. 2 cm. Stavba 1, kv. 668/C4. Inv. št. 22472.

15. Prstan; železo; pr. 2,4 cm. Stavba 1, kv. 669/D2, SE 30. Inv. št. 22313.

– Ciglenečki 2008, sl. 22: 21.

16. Prstan; železo; pr. 2,1 cm. Stavba 1, kv. 716/B1, SE 06. Inv. št. 22826.

17. Prstan; bron; pr. 2,3 cm. Stavba 1, kv. 918/C4, SE 34. Inv. št. 22429.

18. Prstan; železo; pr. 2,2 cm. Stavba 1, kv. 666/C2, SE 34. Inv. št. 22314.

19. Prstan; železo; pr. 1,7 cm. Stavba 1, kv. 618/C2, SE 34. Inv. št. 22316.

20. Prstan; železo; pr. 2 cm. Stavba 1, kv. 669/C2, SE 28. Inv. št. 22312.

– Ciglenečki 2008, sl. 22: 20.

21. Prstan; železo; pr. 2,2 cm. Stavba 1, kv. 617/C3, C4, SE 06. Inv. št. 22319.

22. Prstan; železo; d. 1,4 cm. Stavba 1, kv. 619/B4, SE 34. Inv. št. 22318.

23. Prstan; železo; d. 2,6 cm. Stavba 1, kv. 918/vsi, SE 34. Inv. št. 22724.

24. Prstan; bron; pr. 2,6 cm. Stavba 1, kv. 716/A2, SE 03. Inv. št. 22828.

25. Prstan; bron; pr. 2,2 cm. Stavba 1, kv. 717/B3, SE 22. Inv. št. 22315.

26. Prstan; bron; d. 2,1 cm. Stavba 1, kv. 666/A2,A3,B2,B3, SE 34. Inv. št. 22317.

27. Prstan; bron in steklo/kamen; v. 2,8 cm. Stavba 1. Inv. št. 22452.

– Ciglenečki 1994b, t. 1: 28; 1997a, 30.

28. Okrasni kamen; steklo, kamen?; d. 1, š. 0,9 cm. Stavba 1, kv. 719/C4, SE 26. Inv. št. 23125, sl. 2.3: 9.

29. Uhan; srebro; pr. 1,3 cm. Stavba 1, kv. 816/B4, SE 01. Inv. št. 22825.

#### Tabla 5

1. Obroček; bron. Stavba 1. Detektorska najdba. Založen. – Ciglenečki 1994b, t. 1: 23.

2. Uhan; bron; d. 2,4 cm. Stavba 1, kv. 669/B2, SE 30. Inv. št. 22363.

3. Uhan; bron; pr. 1,7 cm. Stavba 1, kv. 766/B2, SE 24. Inv. št. 22795.

4. Uhan; bron; pr. 2,3 cm. Stavba 1, kv. 669/C1, SE 28. Inv. št. 22362.

– Ciglenečki 1997b, 21; 2005, sl. 8: 10; 2008, sl. 22: 19.

5. Uhan; bron; d. 3 cm. Stavba 1. Inv. št. 23112.

– Ciglenečki 1994a, t. 6: 17; 1994b, t. 1: 24; 1994c, t. 1: 16; 2008, sl. 22: 18.

6. Uhan; bron; pr. 3,5 cm. Stavba 1. Detektorska najdba. Inv. št. 23111.

– Ciglenečki 1994a, t. 6: 18; 1994b, t. 1: 25; 1994c, t. 1: 15; 1997a, 31; 1999b, 334; 2008, sl. 22: 17; Milavec, Modrijan 2007, sl. 11: 7.

7. Zapestnica; železo; d. 7 cm. Stavba 1, kv. 816/C1, SE 09. Inv. št. 22330.
8. Zapestnica; bron; pr. 4,2 cm. Stavba 1, kv. 816/D3, SE 10. Inv. št. 22331.  
– Ciglenečki 1997b, 21; 2005, sl. 8: 11; 2008, sl. 22: 22.
9. Zapestnica; bron; d. 2,5 cm. Stavba 1, kv. 720/B3, SE 01. Inv. št. 22323.
10. Zapestnica; železo; pr. 6,6 cm. Stavba 1, kv. 717/B2, SE 08. Inv. št. 22799.  
– Modrijan 2011, sl. 4: 5.
11. Zapestnica; bron; d. 9,5 cm. Stavba 1, kv. 716/B1, SE 06. Inv. št. 22577.
12. Zapestnica; bron; d. 6,5 cm. Stavba 1, kv. 667/D4. Inv. št. 23392.
13. Zapestnica; bron; d. 3,2 cm. Detektorska najdba. Inv. št. 22775.
14. Zapestnica; bron; d. 1,6 cm. Stavba 1, kv. 666/B1, SE 34. Inv. št. 23217.
15. Zapestnica; bron; d. 2,1 cm. Stavba 1, kv. 716/A1, SE 06. Inv. št. 22829.
16. Kraguljček; bron in kamen; v. 3,1 cm, pr. 2 cm. Stavba 1. Detektorska najdba. Inv. št. 23107.  
– Ciglenečki 1994b, t. 1: 27; 1994c, t. 1: 20.
17. Iгла; srebro; d. 10 cm. Stavba 1, kv. 619/A2, SE 34. Inv. št. 23090.  
– Ciglenečki 1997a, 16; 1997b, 21; 1999d, 350; 2005, sl. 8: 9; 2008, sl. 22: 27; Modrijan 2011, sl. 2: 12.
18. Iгла; bron; d. 10,5 cm. Stavba 1, kv. 768/A3, SE 01. Inv. št. 22294.
19. Iгла; bron; d. 2,2 cm. Stavba 1, kv. 569/B4, SE 34. Inv. št. 23232.
20. Ploščica; srebro; d. 1,8 cm. Stavba 1, kv. 766/A4, SE 14. Inv. št. 22368.

*Tabla 6*

1. Iгла; bron; d. 8,9 cm. Stavba 1, kv. 666/B1, SE 34. Inv. št. 22445.  
– Ciglenečki 2008, sl. 22: 25.
2. Iгла; bron; d. 8,7 cm. Stavba 1, kv. 669/C4, SE 06. Inv. št. 22295.  
– Ciglenečki 2008, sl. 22: 28.
3. Iгла; bron; d. 11 cm. Stavba 1. Detektorska najdba. Inv. št. 23113.  
– Ciglenečki 1994a, t. 6: 16; 1994b, t. 1: 22; 1994c, t. 1: 18.
4. Iгла; bron; d. 11 cm. Stavba 1, kv. 816/D2, SE 09. Inv. št. 22292.  
– Ciglenečki 2008, sl. 22: 24.
5. Iгла; železo; d. 10,2cm. Stavba 1, kv. 669/B2, SE 06. Inv. št. 22794.
6. Iгла; železo; d. 9,8 cm. Stavba 1, kv. 767/B2, SE 10. Inv. št. 22902.
7. Iгла; železo; d. 12,7 cm. Stavba 1, kv. 716/B1, SE 06. Inv. št. 22716.
8. Iгла; železo; d. 10,4 cm. Stavba 1, kv. 669/A4, SE 23. Inv. št. 22801.
9. Iгла; železo; d. 8,5 cm. Stavba 1, kv. 817/C4, SE 03. Inv. št. 23307.
10. Iгла; železo; d. 6,8 cm. Stavba 1, kv. 666/A2, A3, B2, B3, SE 34, 29. Inv. št. 22302.

11. Iгла; železo; d. 7,1 cm. Stavba 1, kv. 668/D1, SE 01. Inv. št. 22523.
12. Iгла; železo; d. 5,5 cm. Stavba 1, kv. 816/D2, SE 09. Inv. št. 22513.
13. Iгла; železo; d. 3,2 cm. Stavba 1, kv. 716/C1, SE 04. Inv. št. 23715.
14. Iгла; železo; d. 2,5 cm. Stavba 1, kv. 716/D1, SE 23. Inv. št. 23262.
15. Iгла; železo; d. 4,5 cm. Stavba 1, kv. 766/A3, SE 01. Inv. št. 22417.

*Tabla 7*

1. Okov pasne spone; bron; d. 3,6 cm. Stavba 1, kv. 666/A3, SE 53. Inv. št. 22216.  
– Milavec, Modrijan 2007, sl. 5: 1.
2. Obroč pasne spone; bron; d. 3,5 cm. Stavba 1. Detektorska najdba. Inv. št. 22494.  
– Ciglenečki 1994a, t. 6: 9; 1994b, t. 1: 14; 1994c, t. 1: 9; 1997a, 31; Milavec, Modrijan 2007, sl. 5: 3.
3. Obroč pasne spone; bron; d. 6,3 cm. Stavba 1, kv. 766/C4, SE 10. Inv. št. 22596.  
– Ciglenečki 1997a, 31; 1997b, 20; 2008, sl. 18: 9.
4. Obroč pasne spone; bron; d. 4,2 cm. Stavba 1, kv. 766/A2, SE 23. Inv. št. 22603.  
– Ciglenečki 1994c, t. 1: 7; 1997b, 20; 2008, sl. 18: 8; Ciglenečki, Milavec 2009, t. 1: 2.
5. Obroč pasne spone; bron; d. 3,4 cm. Stavba 1, kv. 666/C1, SE 29. Inv. št. 22277.  
– Milavec, Modrijan 2007, sl. 5: 5; Ciglenečki 2008, sl. 18: 10.
6. Pasna spona; bron; d. 3,8 cm. Stavba 1, kv. 717/A1, SE 24. Inv. št. 22604.  
– Ciglenečki 1997a, 30; 1997b, 20; 2008, sl. 18: 12; Ciglenečki, Milavec 2009, t. 1: 1.
7. Trn pasne spone; bron; d. 4,9 cm. Stavba 1, kv. 56, SE 24. Inv. št. 22283.  
– Ciglenečki 1994c, t. 1: 13.
8. Trn pasne spone; železo; d. 3,3 cm. Stavba 1, kv. 669/B1, SE 24. Inv. št. 22897.
9. Trn pasne spone; železo; d. 1,9 cm. Stavba 1, kv. 666/C3. Inv. št. 22947.
10. Trn pasne spone; železo; d. 2,5 cm. Stavba 1, kv. 619/A1, SE 34. Inv. št. 22656.
11. Pasna spona; bron. Stavba 1. Detektorska najdba. Založena.  
– Ciglenečki 1994b, t. 1: 20.
12. Pasna spona; bron. Stavba 1. Detektorska najdba. Založena.  
– Ciglenečki 1994b, t. 1: 21.
13. Obroč pasne spone; železo; v. 4,8 cm. Stavba 1, kv. 717/C2, SE 08. Inv. št. 22284.
14. Pasna spona; železo; v. 5,2 cm. Stavba 1, kv. 716/C2, SE 23. Inv. št. 23783.
15. Obroč pasne spone; železo; v. 4,7 cm. Stavba 1, kv. 618/A2, SE 34. Inv. št. 22279.
16. Obroč pasne spone; železo; d. 3,4 cm. Stavba 1, kv. 717/C1. Inv. št. 22891.
17. Obroč pasne spone; železo; d. 3,8 cm. Stavba 1, kv. 669/D4, SE 29a. Inv. št. 22276.
18. Obroč pasne spone; železo; d. 3,7 cm. Stavba 1, kv. 766/A2, SE 24. Inv. št. 22423.

19. Obroč pasne sponje; železo; d. 4 cm. Stavba 1, kv. 766/A4, SE 14. Inv. št. 22286.

20. Obroč pasne sponje; železo; d. 4,3 cm. Stavba 1, kv. 719/C4, SE 01. Inv. št. 22273.

21. Pasna spona; železo; v. 3,8 cm. Stavba 1, kv. 766/A2, SE 24. Inv. št. 23729.

22. Obroč pasne sponje; železo; v. 2,8 cm. Stavba 1, kv. 666/C3/C4, SE 24. Inv. št. 22291.

23. Obroč pasne sponje; železo; pr. 3,2 cm. Stavba 1, kv. 716/C1, SE 06. Inv. št. 22798.

24. Pasna spona; železo; pr. 3 cm. Stavba 1, kv. 716/C3, SE 24. Inv. št. 22281.

25. Obroč pasne sponje; železo; v. 2,3 cm. Stavba 1, kv. 666/A3, SE 56. Inv. št. 22280.

26. Obroč pasne sponje; železo; d. 1,9 cm. Stavba 1, kv. 766/D1, SE 14. Inv. št. 22285.

27. Obroč pasne sponje; železo; d. 2 cm. Stavba 1, kv. 666/A2, A3, B2, B3, SE 34. Inv. št. 23189.

#### Tabla 8

1. Okov pasne sponje; bron; d. 2, š. 2,5 cm. Stavba 1, kv. 769/C1, SE 05. Inv. št. 23382.

– Ciglenečki 1997a, 31; 1997b, 21; 2005, sl. 8: 8; 2008, sl. 22: 12.

2. Obroč pasne sponje; bron; d. 1,5 cm. Stavba 1, kv. 669/D3, SE 26. Inv. št. 22278.

– Ciglenečki 2008, sl. 22: 14.

3. Pasna spona; bron; pribl. 1,8 cm. Stavba 1, kv. 669, SE 06. Inv. št. 22453.

– Ciglenečki 1997a, 31; 1997b, 21; 2005, sl. 8: 7; Milavec, Modrijan 2007, sl. 11: 2.

4. Pasna spona; bron. Stavba 1. Detektorska najdba. Založena.

– Ciglenečki 1997b, 21; 2005, sl. 8: 7; 2008, sl. 22: 13.

5. Obroč pasne sponje; bron; d. 1,6 cm. Stavba 1, kv. 666/C4, SE 24. Inv. št. 23095.

– Ciglenečki 1994c, t. 1: 12.

6. Trn pasne sponje; bron; d. 2,6 cm. Stavba 1. Detektorska najdba. Inv. št. 22493.

– Ciglenečki 1994a, t. 6: 14; 1994b, t. 1: 19; 1994c, t. 1: 11; 2008, sl. 22: 16.

7. Obroč pasne sponje; bron; d. 3,1 cm. Stavba 1, kv. 719/D1, SE 01. Inv. št. 22275.

– Ciglenečki 1997a, 30.

8. Pasna spona; srebro; d. 3,8 cm. Stavba 1, kv. 670. Inv. št. 23092.

– Ciglenečki 1994a, t. 6: 13; 1994b, t. 1: 18; 1994c, t. 1: 10; 1997b, 21; 2005, sl. 8: 6; 2008, sl. 22: 15.

9. Pasni okov; bron; v. 4,6 cm. Stavba 1. Detektorska najdba. Inv. št. 22598.

– Ciglenečki 1994a, t. 6: 11; 1994b, t. 1: 16; 1997a, 31; 1997b, 20; 2008, sl. 18: 17.

10. Pasni okov; bron; v. 4,6 cm. Stavba 1, kv. 717/D4, SE 21. Inv. št. 22599.

– Ciglenečki 1997a, 31; 1997b, 20; 2008, sl. 18: 16.

11. Okov; bron; pr. 1,7 cm. Stavba 1, kv. 719/D4. Inv. št. 22220.

– Ciglenečki 1997b, 20; 2008, sl. 18: 14.

12. Okov; bron; d. 1,5 cm. Stavba 1, kv. 817/D3, SE 03. Inv. št. 22372.

13. Okov; bron; d. 2 cm. Stavba 1, kv. 719/D4. Inv. št. 22381.

– Ciglenečki 2008, sl. 18: 13.

14. Gumb; bron; pr. 1,8 cm. Stavba 1, kv. 719/A1, SE 24. Detektorska najdba. Inv. št. 22620.

– Ciglenečki, Milavec 2009, t. 1: 5.

15. Pasni okov; bron; d. 6,7 cm. Stavba 1. Detektorska najdba. Inv. št. 23106.

– Ciglenečki 1994a, t. 6: 12; 1994b, t. 1: 17; 1994c, t. 1: 8; 1997a, 31; 1997b, 20; 2008, sl. 18: 18; Ciglenečki, Milavec 2009, t. 1: 3.

16. Pasni okov; bron; v. 4,3 cm. Stavba 1. Detektorska najdba. Inv. št. 22597.

– Ciglenečki 1994a, t. 6: 10; 1994b, t. 1: 15; 1994c, t. 1: 6; 1997a, 31; 1997b, 20; 2008, sl. 18: 11; Ciglenečki, Milavec 2009, t. 1: 4.

17. Jermenski zaključek, dve zakovici; bron; v. 4,8 cm. Stavba 1, kv. 818/B1, SE 03. Inv. št. 22605.

– Ciglenečki 1997a, 9; 1997b, 20; 1999d, 352; 2008, sl. 18: 15; Ciglenečki, Milavec 2009, t. 1: 6.

18. Okov; bron; d. 2 cm. Stavba 1, kv. 716/C2, SE 23. Inv. št. 22215.

– Milavec, Modrijan 2007, sl. 11: 1.

19. Okov; bron; d. 4,7, š. 1,5 cm. Stavba 1, kv. 668/D2. Inv. št. 22217.

20. Jermenski zaključek; srebro; d. 1,3 cm. Stavba 1, kv. 766/B3, SE 24. Inv. št. 22274.

21. Okov zorbice; železo; d. 9,5 cm. Stavba 1, kv. 719/C1, SE 01. Inv. št. 22225.

22. Pasni jeziček; bron, železo, pozlata; d. 2,5 cm. Stavba 1, kv. 875. Inv. št. 22492.

– Ciglenečki 1994a, t. 6: 15; 1994b, t. 1: 26; 1994c, t. 1: 14; 1997a, 26, 30; 1997b, 21; 2005, sl. 10: 2; Knific 2007, sl. 2: 16; Milavec, Modrijan 2007, sl. 11: 6; Modrijan 2011, sl. 4: 4.

23. Okov; bron; d. 2,5 cm. Stavba 1, kv. 715/A1, SE 11. Inv. št. 23097.

– Ciglenečki 1997a, 25, 30; 1997b, 21; 2005, sl. 10: 1.

#### Tabla 9

1. Člen oklepa; bron, železo; pr. 0,8 cm. Stavba 1, kv. 668/A2, SE 26. Inv. št. 23129.

2. Okov; bron; pr. 1,7 cm. Stavba 1, kv. 717/B2, SE 01. Inv. št. 23395.

3. Ostroga; železo; d. 5,5 cm. Stavba 1, kv. 918/C2, SE 34. Inv. št. 22977.

4. Del plumbate; svinec; d. 2,4 cm. Stavba 1, kv. 817/C2, SE 01. Inv. št. 22845.

5. Ost kopja; železo; d. 10 cm. Stavba 1, kv. 864, SE 34. Inv. št. 23146.

6. Puščična ost; železo; d. 1,7 cm. Stavba 1, kv. 770/B1, SE 34. Inv. št. 23231.

7. Puščična ost; železo; d. 6,1 cm. Stavba 1, kv. 766/A3, SE 01. Inv. št. 22227.

8. Puščična ost; železo; d. 5,6 cm. Stavba 1, kv. 666/A4/B4, SE 06. Inv. št. 22229.

9. Puščična ost; železo; d. 6 cm. Stavba 1, kv. 666/C2, SE 50. Inv. št. 22232.

– Ciglenečki 2005, sl. 9: 3; 2008, sl. 23: 3.

10. Puščična ost; železo; d. 5 cm. Stavba 1, kv. 968/D1, SE 34. Inv. št. 22235.

– Ciglenečki 2005, sl. 9: 5; 2008, sl. 23: 5.

11. Puščična ost; železo; d. 6,5 cm. Stavba 1, kv. 666/A2, A3, B2, B3, SE 34, 29. Inv. št. 22234.  
– Ciglenečki 2005, sl. 9: 2; 2008, sl. 23: 2.
12. Puščična ost; železo. Stavba 1. Detektorska najdba. Založena.  
– Ciglenečki 1994c, t. 1: 21; 1997b, 21; 2005, sl. 9: 4; 2008, sl. 23: 4.
13. Puščična ost; železo; d. 5,5 cm. Stavba 1, kv. 667/C4, SE 24. Inv. št. 22228.
14. Puščična ost; železo; v. 5,8 cm. Stavba 1, kv. 667/A1, SE 06. Inv. št. 22610.  
– Ciglenečki 2005, sl. 9: 6; 2008, sl. 23: 6.
15. Puščična ost; železo; d. 5,3 cm. Stavba 1, kv. 769/D1, SE 03. Inv. št. 22233.
16. Puščična ost; železo; d. 6,7 cm. Stavba 1, kv. 619/C4, SE 34. Inv. št. 22609.  
– Ciglenečki 2005, sl. 9: 7; 2008, sl. 23: 7.
17. Puščična ost; železo; d. 6,1 cm. Stavba 1, kv. 968/B2, SE 34. Inv. št. 22611.  
– Ciglenečki 2005, sl. 9: 8; 2008, sl. 23: 8.
18. Puščična ost; železo; d. 4,7 cm. Stavba 1, kv. 669/A3, SE 24. Inv. št. 23737.
19. Puščična ost; železo; d. 6,7 cm. Stavba 1, kv. 619/B3, SE 34. Inv. št. 22236.  
– Ciglenečki 2005, sl. 9: 1; 2008, sl. 23: 1.
20. Puščična ost; železo; d. 4,6 cm. Stavba 1, kv. 817/B3, SE 06. Inv. št. 22231.
21. Puščična ost; železo; d. 6,5 cm. Stavba 1, kv. 719/C3, SE 05. Inv. št. 22230.  
– Ciglenečki 2005, sl. 9: 10; 2008, sl. 23: 10.
22. Puščična ost; železo; d. 3,1 cm. Stavba 1, kv. 817/D1, SE 05. Inv. št. 22887.
23. Puščična ost; železo; d. 4,5 cm. Stavba 1, kv. 716/B1, SE 06. Inv. št. 22614.  
– Ciglenečki 1997b, 21; 2005, sl. 9: 11; 2008, sl. 23: 11.
24. Tul puščične osti; železo; d. 3 cm. Stavba 1, kv. 720/A4, SE 07. Inv. št. 22454.

Tabla 10

1. Puščična ost; železo; d. 8,6 cm. Stavba 1, kv. 666/B1, SE 29. Inv. št. 22342.
2. Puščična ost; železo; d. 6,6 cm. Stavba 1, kv. 619/B3, SE 64. Inv. št. 22616.
3. Puščična ost; železo; d. 6,2 cm. Stavba 1, kv. 766/B1, SE 24. Inv. št. 22886.
4. Puščična ost; železo; d. 6,1 cm. Stavba 1, kv. 766/A2. Inv. št. 22797.
5. Puščična ost; železo; d. 6,2 cm. Stavba 1, kv. 618/D1, D2, SE 34. Inv. št. 23327.
6. Puščična ost; železo; d. 8,4 cm. Stavba 1, kv. 666/C3, SE 23. Inv. št. 23803.
7. Puščična ost; železo; d. 8,8 cm. Stavba 1, kv. 816/D1, SE 68. Inv. št. 23809.
8. Puščična ost; železo; d. 7 cm. Stavba 1, kv. 669/D3, SE 06. Inv. št. 22241.
9. Puščična ost; železo. Stavba 1. Detektorska najdba. Založena.  
– Ciglenečki 1997b, 21.
10. Puščična ost; železo; d. 4,3 cm. Stavba 1, kv. 817/D2, SE 34. Inv. št. 23303.

11. Puščična ost; železo; d. 7 cm. Stavba 1, kv. 666/C4, SE 52. Inv. št. 23164.
12. Puščična ost; železo; d. 5 cm. Stavba 1, kv. 619/D4, SE 34. Inv. št. 22615.  
– Ciglenečki 2005, sl. 9: 12; 2008, sl. 23: 12.
13. Puščična ost; železo; d. 6,6 cm. Stavba 1, kv. 717/C3, SE 10. Inv. št. 22238.  
– Milavec, Modrijan 2007, sl. 11: 4.
14. Puščična ost; železo; d. 10,4 cm. Stavba 1, kv. 817, SE 05. Inv. št. 22237.
15. Puščična ost; železo; d. 9 cm. Stavba 1, kv. 912/B3, SE 34. Inv. št. 22239.
16. Puščična ost; železo; d. 5 cm. Stavba 1, kv. 717/C3, SE 23. Inv. št. 22612.  
– Ciglenečki 1997b, 21; 2005, sl. 9: 9; 2008, sl. 23: 9.
17. Puščična ost; železo; d. 9,2 cm, š. 1,4 cm. Stavba 1, kv. 847, SE 06. Inv. št. 22893.

Tabla 11

1. Puščična ost; železo; d. 7,9 cm. Stavba 1, kv. 666/C2, SE 34. Inv. št. 22613.  
– Ciglenečki 1997b, 21.
2. Puščična ost; železo; d. 6,7 cm. Stavba 1, kv. 718/A2, SE 10. Inv. št. 22240.  
– Milavec, Modrijan 2007, sl. 11: 5.
3. Lamela oklepa; železo; d. 3,7 cm. Stavba 1, sečišče kv. 468, 469, 509, 510, SE 34. Inv. št. 22878.
4. Lamela oklepa; železo; d. 3,3 cm, š. 1,8 cm. Stavba 1, kv. 719/A1/A2, SE 06. Inv. št. 22529.
5. Lamela oklepa; železo; d. 3,6 cm. Stavba 1, kv. 719/A2, SE 07. Inv. št. 23300.
6. Lamela oklepa; železo; d. 4 cm. Stavba 1, kv. 666/B1, SE 34. Inv. št. 23216.
7. Katapultni izstrelek; železo; d. 15 cm. Stavba 1, kv. 870/C1, SE 34, 69. Inv. št. 23173.
8. Okov; bron; d. 5,7 cm. Stavba 1, kv. 717/D3. Inv. št. 23393.
9. Ščitnik ročaja meča; bron; d. 7,1 cm. Stavba 1. Detektorska najdba. Inv. št. 22822.  
– Ciglenečki 1994a, t. 6: 22; 1994b, t. 2: 11.
10. Dvorezen meč; železo; d. 60 cm. Širše območje stavbe 1. Detektorska najdba. Inv. št. 22606.  
– Ciglenečki 1994a, t. 6: 23; 1994b, t. 4: 9; 1994c, t. 1: 22; 2005, sl. 9: 16; 2008, sl. 23: 17.

Tabla 12

1. Ščitnik ročaja noža; bron; d. 4,6 cm. Stavba 1, kv. 618/D2, SE 34. Inv. št. 22371.  
– Ciglenečki 1997a, 31.
2. Kosa; železo; d. 10,5 cm. Stavba 1, kv. 669/D1, SE 06. Inv. št. 22346.
3. Kosa; železo; d. 5 cm. Stavba 1, kv. 667/A4, SE 06. Inv. št. 22354.
4. Kosir; železo; d. 7 cm. Stavba 1, kv. 666/A2, SE 29. Inv. št. 23221.
5. Kosir; železo; pr. 4,4 cm. Stavba 1, kv. 667/C 3, SE 01. Inv. št. 22563.

6. Kosir; železo; pr. 4,4 cm. Stavba 1, kv. 717/D4, SE 21. Inv. št. 22526.
7. Kosir; železo; pr. 3,7 cm. Stavba 1, kv. 716/A2, SE 68. Inv. št. 23779.
8. Kosir; železo; pr. 2,7 cm. Stavba 1, kv. 618/D1, D2, SE 34. Inv. št. 23328.
9. Kosir; železo; pr. 3,6cm. Stavba 1, kv. 766/B/B3, SE 01. Inv. št. 22687.
10. Kosir; železo; pr. 3 cm. Stavba 1, kv. 867, SE 05. Inv. št. 22444.
11. Kosir; železo. Stavba 1. Detektorska najdba.Založen. – Ciglenečki 1994b, t. 3: 2.
12. Okov; železo; d. 8,3 cm, š. 4 cm. Stavba 1, kv. 669/A1, SE 07. Inv. št. 22530.
13. Okov; železo; d. 8,8 cm. Stavba 1, kv. 716/C3, SE 03. Inv. št. 22572.

Tabla 13

1. Okov; železo; d. 11,3 cm. Stavba 1, kv. 716/C3. Inv. št. 22571.
2. Okov; železo; d. 9,5 cm. Stavba 1. Inv. št. 23108. – Ciglenečki 1994b, t. 4: 8.
3. Okov; železo; d. 9,4 cm. Stavba 1, kv. 816/D1, SE 24. Inv. št. 23808.
4. Okov; železo; d. 8,6 cm. Stavba 1, kv. 719/C4, SE 06. Inv. št. 22505.
5. Rezilo; železo; v. 8,5 cm. Stavba 1. Detektorska najdba. Inv. št. 22584. – Ciglenečki 1994b, t. 2: 18.
6. Rezilo; železo; v. 9,4 cm. Stavba 1. Detektorska najdba. Inv. št. 22583. – Ciglenečki 1994b, t. 2: 19.
7. Srp; železo; d. 20 cm. Stavba 1. Detektorska najdba. Inv. št. 23105. – Ciglenečki 1994b, t. 3: 1.

Tabla 14

1. Lemež rala; železo; d. 28,5 cm. Stavba 1, kv. 817/C2, SE 08. Inv. št. 23891.
2. Črtalo rala; železo; d. 59 cm. Stavba 1, kv. 817/C2, SE 08. Inv. št. 23892.
3. Veriga iz treh členov; železo; d. člena do 8,9 cm. Stavba 1, kv. 668/C2, SE 26. Inv. št. 22496.
4. Čelo sekire; železo; d. 9,2 cm. Stavba 1, kv. 667/C3, SE 01. Inv. št. 22564.
5. Čelo sekire; železo; d. 9 cm. Stavba 1, kv. 870/B1, SE 34. Inv. št. 22769.
6. Rezilo sekire; železo; d. 5 cm. Stavba 1, kv. 716/D4, SE 23. Inv. št. 23769.
7. Rezilo sekire; železo; d. 5 cm. Stavba 1, kv. 716/C2, SE 23. Inv. št. 23748.
8. Rezilo sekire; železo; d. 5,4 cm. Stavba 1, kv. 769/A1, SE 01. Inv. št. 22536.

Tabla 15

1. Sveder; železo; d. 5,7 cm. Stavba 1, kv. 968/C1, SE 34. Inv. št. 23348.
2. Sveder; železo; d. 10 cm. Stavba 1, kv. 619/A3, SE 67. Inv. št. 22735.
3. Sveder; železo. Stavba 1. Detektorska najdba.Založen. – Ciglenečki 1994b, t. 2: 24.
4. Sveder; železo; d. 9,5 cm. Stavba 1, kv. 767/B2, SE 10. Inv. št. 23314.
5. Sveder; železo; d. 22 cm. Stavba 1, kv. 766/A ali B3. Inv. št. 23183.
6. Sveder; železo; d. 20,8 cm. Stavba 1. Detektorska najdba. Inv. št. 23117. – Ciglenečki 1994b, t. 4: 7.
7. Sveder; železo; d. 4,7 cm. Stavba 1, kv. 668/B1, SE 26. Inv. št. 23811.
8. Sveder; železo; d. 4 cm. Stavba 1, kv. 569/C2, SE 34. Inv. št. 23196.
9. 9 zob železnega glavnika; železo; d. 7,1 do 8,2 cm. Stavba 1, kv. 767/B2, SE 10. Inv. št. 22884.

Tabla 16

1. Trnek; železo; v. 2,5 cm. Stavba 1, kv. 817/B2,B3, SE 13. Inv. št. 22339.
2. Trnek; železo; v. 3,4 cm. Stavba 1, kv. 666/C1, SE 34. Inv. št. 22345.
3. Trnek; železo; v. 2,5 cm. Stavba 1, kv. 718/B1, SE 08. Inv. št. 23714.
4. Trnek; železo; v. 2,7 cm. Stavba 1, kv. 669/B3, SE 24. Inv. št. 23690.
5. Trnek; železo; v. 3,8 cm. Stavba 1, kv. 718/C1, SE 10. Inv. št. 22674.
6. Trnek; železo; v. 3 cm. Stavba 1, kv. 669/B3, SE 29a. Inv. št. 22344.
7. Trnek; železo; v. 3,2 cm. Stavba 1, kv. 766/A2. Inv. št. 22364.
8. Trnek; železo; v. 3,4 cm. Stavba 1, kv. 619/D2, SE 34. Inv. št. 23361.
9. Vretence; svinec; pr. 2,9 cm. Stavba 1, kv. 667/A4. Inv. št. 22420.
10. Vretence; svinec; pr. 2,2 cm. Stavba 1, kv. 817/A2, SE 08. Inv. št. 22373.
11. Vretence; svinec. Detektorska najdba.Založeno.
12. Vretence; svinec; pr. 2 cm. Stavba 1, kv. 667/D1. Inv. št. 22422.
13. Vretence; kost; pr. 1,4 cm. Stavba 1, kv. 717/C2, SE 10. Inv. št. 23374.
14. Vretence; svinec. Stavba 1. Detektorska najdba.Založeno. – Ciglenečki 1994b, t. 2: 13.
15. Vretence; svinec; pr. 1 cm. Stavba 1, kv. 669/B2, SE 07. Inv. št. 22831.
16. Obroček; bron. Stavba 1. Detektorska najdba.Založen. – Ciglenečki 1994b, t. 2: 8; 1994c, t. 1: 17.
17. Glavnik; železo; d. 8 cm. Stavba 1, kv. 669/C2, SE 30. Inv. št. 23807.
18. Vretence; keramika; barva zunaj, znotraj in v prelomu: oranžna; dodatki: zdrobljena keramika; površina: mehka. Stavba 1, kv. 719/C2, SE 26. Inv. št. 20601.

19. Vretence; keramika; barva zunaj, znotraj in v prelomu: rjava; dodatki: apnenec; površina: mehka. Stavba 1, kv. 718/B4, SE 36. Inv. št. 20485.

20. Vretence; keramika; barva zunaj, znotraj in v prelomu: oranžna; dodatki: apnenec; površina: mehka. Stavba 1, kv. 666/B1, SE 34. Inv. št. 22198.

21. Vretence; keramika; barva zunaj, znotraj in v prelomu: oranžna; brez vidnih primesi; površina: mehka. Stavba 1, kv. 717/D1, SE 04. Inv. št. 20574.

22. Vretence; keramika; barva zunaj, znotraj in v prelomu: oranžna; brez vidnih primesi; površina: mehka. Stavba 1, kv. 619/A2, SE 34, Inv. št. 20586.

23. Vretence; keramika; barva zunaj, znotraj in v prelomu: oranžna; brez vidnih primesi; površina: mehka. Stavba 1, kv. 768/C3, SE 01. Inv. št. 21861.

24. Vretence; keramika; barva zunaj, znotraj in v prelomu: oranžna; brez vidnih primesi; površina: mehka. Stavba 1, kv. 716/C3, SE 23. Inv. št. 22061.

25. Vretence; keramika; barva zunaj, znotraj in v prelomu: oranžna; brez vidnih primesi; površina: mehka. Stavba 1, kv. 817/D1, Inv. št. 20147.

#### Tabla 17

1. Vretence; keramika; barva zunaj, znotraj in v prelomu: temno siva; brez vidnih primesi; površina: trda. Stavba 1, kv. 717/B3, SE 77. Inv. št. 20892.

2. Vretence; keramika; barva zunaj, znotraj in v prelomu: oranžna; brez vidnih primesi; površina: mehka. Stavba 1, kv. 669/A1, SE 34. Inv. št. 24001.

3. Vretence; keramika; barva zunaj, znotraj in v prelomu: temno siva; brez vidnih primesi; površina: trda. Naključna najdba izven izkopnega polja. Inv. št. 24012.

4. Vretence; keramika; barva zunaj, znotraj in v prelomu: temno siva; brez vidnih primesi; površina: trda. Naključna najdba izven izkopnega polja. Inv. št. 24052.

5. Vretence; keramika; barva zunaj, znotraj in v prelomu: oranžna; dodatki: apnenec, zdrobljena keramika; površina: trda. Naključna najdba izven izkopnega polja. Inv. št. 24069.

6. Svitek; svinec. Stavba 1. Detektorska najdba. Založen.  
– Ciglenečki 1994b, t. 2: 12.

7. Svitek; svinec; d. 1,6 cm. Stavba 1, kv. 667/A4, SE 06. Inv. št. 22421.

8. Svitek; svinec; d. 3 cm. Stavba 1, kv. 716/B4, SE 23. Inv. št. 22466.

9. Svitek; svinec; pr. 1,6 cm. Stavba 1, kv. 669/B3, SE 24. Inv. št. 23741.

10. Svitek; svinec; d. 3,3 cm. Stavba 1, kv. 717/A4, SE 36. Inv. št. 23751.

11. Svinčen predmet; svinec; d. 2,6 cm. Stavba 1, kv. 668/B1, SE 26. Inv. št. 23810.

12. Svinčen predmet; svinec; pr. 2 cm. Stavba 1, kv. 718/C1. Inv. št. 22833.

13. Šivanka; železo; d. 5,3 cm. Stavba 1, kv. 769/C3, SE 34. Inv. št. 22347.

14. Šivanka; železo; d. 4,3 cm. Stavba 1, kv. 666/A3, SE 45. Inv. št. 22258.

15. Šivanka; železo; d. 7,9 cm. Stavba 1, kv. 716/A4, SE 23. Inv. št. 22298.

16. Šivanka; železo; d. 5 cm. Stavba 1, kv. 618/D2, SE 34. Inv. št. 22301.

17. Šivanka; železo; d. 4 cm. Stavba 1, kv. 666/C2, SE 56. Inv. št. 22300.

18. Šivanka; železo; d. 3 cm. Stavba 1, kv. 669/D1, SE 03. Inv. št. 22299.

19. Šivanka; železo; d. 4,1 cm. Stavba 1, kv. 619/A1, SE 34. Inv. št. 22652.

20. Šivanka; železo; d. 3,9 cm. Stavba 1, kv. 716/B2, SE 06. Inv. št. 22779.

21. Šivanka; železo; d. 3 cm. Stavba 1, kv. 669/C1, SE 07. Inv. št. 22433.

22. Šivanka; železo; d. 5,4 cm. Stavba 1, kv. 669/A1, SE 01. Inv. št. 22461.

23. Šivanka; železo; d. 8,3 cm. Stavba 1, kv. 716/B 2, SE 06. Inv. št. 22521.

24. Šivanka; železo; d. 5,5 cm. Stavba 1, kv. 666/C4, SE 06. Inv. št. 22741.

25. Šivanka; železo; d. 5 cm. Stavba 1, kv. 667/D2, SE 24. Inv. št. 23316.

26. Šivanka; železo; d. 6,3 cm. Stavba 1, kv. 669/A3, A4, B3, B4, SE 29a. Inv. št. 22970.

27. Šivanka; železo; d. 7,3 cm. Stavba 1, kv. 666/D3, SE 23. Inv. št. 23133.

28. Šivanka; železo; d. 6,8 cm. Stavba 1, kv. 669/B3, SE 29. Inv. št. 23317.

29. Šivanka; železo; d. 5,5 cm. Stavba 1, kv. 766/A1, SE 23. Inv. št. 23318.

30. Šivanka; železo; d. 7,3 cm. Stavba 1, kv. 666/A2, SE 56. Inv. št. 23206.

31. Šivanka; železo; d. 4,8 cm. Stavba 1, kv. 669/A2, SE 23. Inv. št. 23767.

32. Šivanka; železo; d. 7,6 cm. Stavba 1, kv. 668/D3, SE 29. Inv. št. 23761.

#### Tabla 18

1. Trakasti obroč; železo; pr. 18 cm. Stavba 1, kv. 817/C3, SE 25. Inv. št. 23380.

2. Trakasti obroč; železo; pr. 17 cm. Stavba 1, kv. 817/C3, SE 25. Inv. št. 23381.

3. Pestni obroč; železo; pr. 11,5 cm. Stavba 1, kv. 817/C3, SE 25. Inv. št. 23378.

4. Pestni obroč; železo; pr. 12,7 cm. Stavba 1, kv. 817/C3, SE 25. Inv. št. 23379.

5. Stilus; železo; d. 11,2 cm. Stavba 1, kv. 716/B1, SE 06. Inv. št. 22337.

6. Stilus; železo; d. 16 cm. Stavba 1, kv. 669/C3, SE 06. Inv. št. 22293.

– Ciglenečki 2008, sl. 22: 26.

7. Stilus; železo; d. 15,3 cm. Stavba 1, kv. 719/C2, SE 01. Inv. št. 22297.

– Ciglenečki 2008, sl. 22: 30.

8. Stilus; železo; d. 14,2 cm. Stavba 1, kv. 716/B1, SE 06. Inv. št. 22717.

9. Stilus; železo; d. 9,6 cm. Stavba 1, kv. 719/B4, SE 05. Inv. št. 22792.

10. Stilus; železo; d. 15 cm. Stavba 1, kv. 619/B3, SE 67. Inv. št. 22601.

Tabla 19

1. Šilo; železo; d. 22 cm. Stavba 1, kv. 720/B2, SE 07. Inv. št. 22375.
2. Šilo; železo; d. 22,1 cm. Stavba 1. Detektorska najdba. Inv. št. 23116.  
– Ciglenečki 1994b, t. 2: 25.
3. Lopatka za vosek; železo; d. 11,6 cm. Stavba 1, kv. 666/D1, SE 23. Inv. št. 22885.
4. Kladiyce; železo; d. 3,7 cm. Stavba 1, kv. 867/A4, B3, B4, C2-C4, D1-D4, SE 34. Inv. št. 22388.
5. Lopatka; železo; v. 4,2 cm. Stavba 1, kv. 815/C2, SE 06. Inv. št. 22424.
6. Lopatka; železo; d. 4 cm. Stavba 1, kv. 669/C1, SE 07. Inv. št. 22432.
7. Škarje; železo; d. 8,3 cm. Stavba 1, kv. 717/B3, SE 36. Inv. št. 22267.
8. Škarje; železo; d. 19,5 cm, š. 2,4 cm. Stavba 1, kv. 716/C3, SE 23. Inv. št. 22498.
9. Šilo; železo; d. 14,6 cm. Stavba 1, kv. 767/A4, SE 08. Inv. št. 22506.
10. Šilo; železo; d. 13,8 cm. Stavba 1, kv. 669/C1, SE 29. Inv. št. 22338.  
– Ciglenečki 2008, sl. 22: 29.
11. Šilo; železo; d. 6,8 cm. Stavba 1, kv. 870/C3, SE 34. Inv. št. 22414.
12. Šilo; železo; d. 7,5 cm. Stavba 1, kv. 716/B1, SE 06. Inv. št. 23259.
13. Šilo; železo; d. 8,4 cm. Stavba 1, kv. 716/C 1, SE 06. Inv. št. 22520.
14. Železen predmet; železo; d. 8 cm. Stavba 1, kv. 816/B1, SE 09. Inv. št. 22688.
15. Orodje; železo; d. 7,4 cm. Stavba 1, kv. 618/B3, SE 34. Inv. št. 23357.
16. Orodje; železo; d. 7,6 cm. Stavba 1, kv. 666/A1, SE 34. Inv. št. 22336.

Tabla 20

1. Ročaj; železo; d. 12 cm. Stavba 1, kv. 669/B1, SE 32. Inv. št. 23132.
2. Ročaj; železo; d. 17 cm. Stavba 1, kv. 666/B1, SE 29. Inv. št. 23184.
3. Ataša; železo; d. 5,4 cm. Stavba 1, kv. 666/A2, SE 34. Inv. št. 22223.
4. Ataša; železo; d. 2,7 cm. Stavba 1, kv. 716/B4, SE 23. Inv. št. 22750.
5. Ataša; železo; d. 4 cm. Stavba 1, kv. 669/A3,A4,B3,B4, SE 23. Inv. št. 22965.
6. Ataša; železo; d. 13 cm. Stavba 1, kv. 958/957, SE 06. Inv. št. 23182.
7. Ataša; železo; v. 3,7 cm. Stavba 1, kv. 719/A1. Inv. št. 23712.
8. Ataša; železo; š. 5 cm. Stavba 1, kv. 666/A2, SE 56. Inv. št. 22443.
9. Ataša; železo; d. 4,6 cm. Stavba 1, kv. 717/A1, SE 23. Inv. št. 23281.
10. Ataša; železo; d. 3,4 cm. Stavba 1, kv. 669/D3, SE 07. Inv. št. 22556.

Tabla 21

1. Ataša; železo; d. 7,6 cm. Stavba 1, kv. 766/A1, SE 01. Inv. št. 23293.
2. Ataša; železo; d. 7 cm. Stavba 1, kv. 816/C4, SE 10. Inv. št. 22527.
3. Ataša; železo; d. 5,2 cm. Stavba 1, kv. 669/C3, SE 10. Inv. št. 23299.
4. Ataša; železo; d. 3,5 cm. Stavba 1, kv. 720/B2, SE 01. Inv. št. 23296.
5. Kavelj; železo; d. 10,4 cm. Stavba 1, kv. 669/C4, SE 01. Inv. št. 22911.
6. Ataša; železo; d. 10 cm. Stavba 1, kv. 669/C4, SE 30. Inv. št. 23122.
7. Trak; železo; d. 5 cm. Stavba 1, kv. 766/A3, SE 01. Inv. št. 22214.
8. Trak; železo; d. 5,3 cm. Stavba 1, kv. 666/C4, SE 24. Inv. št. 22786.
9. Trak; železo; d. 12,1 cm. Stavba 1, kv. 667/C4, SE 24. Inv. št. 22566.
10. Trak; železo; d. 2,8 cm. Stavba 1, kv. 666/C3, SE 06. Inv. št. 23313.
11. Trak; železo; d. 2,6 cm. Stavba 1, kv. 669/C4, SE 01. Inv. št. 22541.
12. Trak; železo; d. 6,3 cm. Stavba 1, kv. 716/C4, SE 23. Inv. št. 23771.
13. Trak; železo; d. 6,2 cm. Stavba 1, kv. 716/C4, SE 23. Inv. št. 23771.
14. Trak; železo; d. 2,7 cm. Stavba 1, kv. 718/A2, SE 11. Inv. št. 22226.
15. Orodje; železo; d. 7,6 cm. Stavba 1. Detektorska najdba. Inv. št. 23780.

Tabla 22

1. Kavelj; železo; d. 9 cm. Stavba 1, kv. 870/C1, SE 34, 69. Inv. št. 23179.
2. Novčna utež; bron; d. in š. 1,5 cm, m. 3,93 g. Stavba 1. Detektorska najdba. Inv. št. 22837.
3. Pečat; svinec; pr. 1,8 cm. Stavba 1, kv. 719/B1, SE 32. Inv. št. 24138.
4. Del tehtnice; železo; d. 23 cm. Stavba 1, kv. 718/A 4, SE 21. Inv. št. 22511.
5. Kavelj; železo; d. 7,4 cm. Stavba 1, kv. 716/B3, SE 24. Inv. št. 23727.
6. Kavelj; železo; d. 10 cm. Stavba 1, kv. 669/C1, SE 06. Inv. št. 22434.
7. Kavelj; železo; d. 7,2 cm. Stavba 1, kv. 719/B4, SE 06. Inv. št. 22802.
8. Kavelj; železo; d. 10 cm. Stavba 1. Detektorska najdba. Inv. št. 22582.  
– Ciglenečki 1994b, t. 2: 20.
9. Kavelj; železo; d. 4 cm. Stavba 1, kv. 717/B2, SE 01. Inv. št. 23305.
10. Zanka; železo; d. 4 cm. Stavba 1, kv. 718/A4, SE 21. Inv. št. 22503.
11. Železen predmet; železo; d. 4,4 cm. Stavba 1, kv. 766/B1, SE 24. Inv. št. 23758.
12. Zanka; železo; d. 6,4 cm. Stavba 1, kv. 669/A3, SE 30. Inv. št. 23708.

13. Utež; svinec in železo; d. 4,1 cm, m. 78,50 g. Stavba 1, kv. 716/D1, SE 21. Inv. št. 22450.

*Tabla 23*

1. Dleto; železo; d. 5,5 cm. Stavba 1, kv. 769/D1, SE 03. Inv. št. 23226.
2. Dleto; železo; d. 5,7 cm. Stavba 1, kv. 666/C2, SE 34. Inv. št. 22341.
3. Dleto; železo; d. 11,5 cm. Stavba 1. Detektorska najdba. Inv. št. 23335.
4. Dleto; železo; d. 12 cm. Stavba 1, kv. 716/C1, SE 06. Inv. št. 22546.
5. Dleto; železo; 7,7 cm. Stavba 1, kv. 669/B3, SE 07. Inv. št. 22524.
6. Nož; železo; d. 11 cm. Stavba 1, kv. 666/D2. Inv. št. 22888.
7. Nož; železo; d. 12,3 cm. Stavba 1, kv. 870/B2, SE 01. Inv. št. 22867.
8. Nož; železo; d. 12,5 cm. Stavba 1, kv. 717/B2, SE 01. Inv. št. 22690.
9. Nož; železo; d. 11,3 cm. Stavba 1, kv. 719/B1, SE 24. Inv. št. 22589.
10. Nož; železo; d. 10,5 cm. Stavba 1, kv. 718/A1, SE 11. Inv. št. 22561.
11. Nož; železo; d. 14,2 cm. Stavba 1, kv. 666/A4, SE 06. Inv. št. 22537.
12. Nož; železo; d. 10,7 cm. Stavba 1, kv. 667/A2, SE 34. Inv. št. 22451.
13. Nož; železo; d. 5,4 cm. Stavba 1, kv. 716/B2, SE 29. Inv. št. 22889.
14. Nož; železo; d. 5,2 cm. Stavba 1, kv. 666/A2,A3,B2,B3, SE 29. Inv. št. 22855.
15. Nož; železo; d. 5,6 cm. Stavba 1, kv. 920, SE 34. Inv. št. 22646.
16. Nož; železo; d. 5,7 cm. Stavba 1, kv. 716/C4, SE 24. Inv. št. 23749.
17. Nož; železo; d. 4,6 cm. Stavba 1, kv. 817/D2, SE 03. Inv. št. 23302.

*Tabla 24*

1. Nož; železo; d. 11,6 cm. Stavba 1, kv. 669/D3, SE 01. Inv. št. 22446.  
– Ciglencečki 2005, sl. 8: 13; 2008, sl. 23: 14.
2. Nož; železo; d. 12,5 cm. Stavba 1, kv. 666, SE 29. Inv. št. 22270.
3. Nož; železo; d. 10 cm. Stavba 1, kv. 667/A3, SE 06. Inv. št. 22418.
4. Nož; železo; d. 7,8 cm. Stavba 1, kv. 716/B3, SE 06. Inv. št. 22272.
5. Nož; železo; d. 8,7 cm, š. 1,7 cm. Stavba 1, kv. 718/A4, SE 21. Inv. št. 22502.
6. Nož; železo; d. 7,8 cm. Stavba 1, kv. 619/C2, SE 34. Inv. št. 22892.
7. Nož; železo; d. 9,4 cm. Stavba 1, kv. 816/A2, SE 01. Inv. št. 22714.
8. Nož; železo; d. 9,5 cm. Stavba 1, kv. 716/B3, SE 24. Inv. št. 23750.
9. Nož; železo; d. 10,7 cm. Stavba 1, kv. 669, SE 06. Inv. št. 22474.

- Ciglencečki 2008, sl. 23: 13.
10. Nož; železo; d. 4 in 5 cm. Stavba 1, kv. 817/C4, SE 03. Inv. št. 23306.
  11. Nož; železo; d. 6,5 cm. Stavba 1, kv. 666/A1, SE 29. Inv. št. 23224.
  12. Nož; železo; d. 5 cm. Stavba 1, kv. 719/D1, SE 01. Inv. št. 23310.
  13. Nož; železo; d. 7 cm. Stavba 1, kv. 769/C1, SE 05. Inv. št. 23309.
  14. Nož; železo; d. 14 cm. Stavba 1, kv. 766/B2, SE 24. Inv. št. 23334.
  15. Nož; železo; d. 13 cm. Stavba 1, kv. 766/C1, SE 23. Inv. št. 23134.
  16. Nož; železo; d. 8,8 cm. Stavba 1, kv. 870/C4, SE 34. Inv. št. 23342.

*Tabla 25*

1. Nož; železo; d. 5,7 cm. Stavba 1, kv. 716/A2, SE 01. Inv. št. 22271.
2. Nož; železo; d. 7,2 cm. Stavba 1, kv. 666/B3, SE 29. Inv. št. 22266.
3. Nož; železo; d. 6 cm. Stavba 1, kv. 719/D1, SE 01. Inv. št. 23312.
4. Nož; železo; d. 8 cm. Stavba 1, kv. 716/B3, SE 24. Inv. št. 22442.
5. Nož; železo; d. 10 cm. Stavba 1, kv. 870/C2, SE 69. Inv. št. 23162.
6. Nož; železo; d. 10,7 cm. Stavba 1. Detektorska najdba. Inv. št. 22592.  
– Ciglencečki 1994b, t. 4: 2.
7. Nož; železo; d. 12,3 cm. Stavba 1. Detektorska najdba. Inv. št. 22593.  
– Ciglencečki 1994b, t. 4: 3, 2005, sl. 9: 14; 2008, sl. 23: 15.
8. Nož; bron; d. 17 cm. Stavba 1. Detektorska najdba. Inv. št. 22595.  
– Ciglencečki 1994b, t. 4: 5.
9. Nož; železo; d. 7,3 cm. Stavba 1, kv. 917/B4, SE 34. Inv. št. 22269.
10. Nož; železo; d. 7,1 cm. Stavba 1, kv. 666/B4, SE 50. Inv. št. 22268.
11. Nož; železo; d. 7,3 cm. Stavba 1, kv. 669/A1, SE 29. Inv. št. 23695.
12. Nož; železo; d. 6 cm. Stavba 1, kv. 619/B1, SE 64. Inv. št. 22590.
13. Nož; železo; d. 7,5 cm. Stavba 1, kv. 619/A2, SE 34. Inv. št. 23343.
14. Nož; železo; d. 8,7 cm. Stavba 1, kv. 663/C3. Inv. št. 22788.

*Tabla 26*

1. Nož; železo; d. 18 cm. Stavba 1. Detektorska najdba. Inv. št. 22594.  
– Ciglencečki 1994b, t. 4: 4, 2005, sl. 9: 15; 2008, sl. 23: 16; Modrijan 2011, sl. 4: 6.
2. Nož; železo; d. 7,8 cm. Stavba 1, kv. 767/D3, SE 10. Inv. št. 22499.
3. Nož; železo; d. 3,8 cm. Stavba 1, kv. 717/D4, SE 10. Inv. št. 23320.



4. Nož; železo; d. 6,2 cm. Stavba 1, kv. 816/D2, SE 09. Inv. št. 22515.

5. Nož; železo; d. 11,6 cm. Stavba 1, kv. 816/C1, SE 09. Inv. št. 22500.

6. Okov nožnice; železo; d. 7,3 cm. Stavba 1, kv. 718/A2, SE 10. Inv. št. 22650.

– Modrijan 2011, sl. 4: 3.

7. Del nožnice; železo; d. 3 cm. Stavba 1, kv. 668/ABCD 4, BC 3, SE 10. Inv. št. 23256.

– Modrijan 2011, sl. 4: 1.

8. Del nožnice; železo; d. 2,5 cm. Stavba 1, kv. 668/ABCD 4, BC 3, SE 10. Inv. št. 23257.

– Modrijan 2011, sl. 4: 2.

9. Orodje; železo; d. 7,6 cm. Stavba 1, kv. 669/C3, SE 30. Inv. št. 23784.

10. Orodje; železo; d. 17 cm. Stavba 1, kv. 816/D3, SE 10. Inv. št. 22774.

Tabla 27

1. Nož; železo. Stavba 1. Detektorska najdba. Založen.

– Ciglencečki 1994b, t. 3.

2. Nož; železo. Stavba 1. Detektorska najdba. Založen.

– Ciglencečki 1994b, t. 4: 6.

Tabla 28

1. Obroč; železo; pr. 6 cm. Stavba 1, kv. 666/A2,A3,B2,B3, SE 34, 29. Inv. št. 22854.

2. Obroček; železo; pr. 5,5 cm. Stavba 1, kv. 717/D4, SE 21. Inv. št. 22568.

3. Obroček; železo; pr. 3,8 cm. Stavba 1, kv. 870/B2. Inv. št. 22865.

4. Obroček; železo; pr. 3,4 cm. Stavba 1, kv. 718/C3, SE 10. Inv. št. 22326.

5. Obroček; železo; pr. 2,4 cm. Stavba 1, kv. 719/C1, SE 01. Inv. št. 22551.

6. Okov nožnice; železo; d. 8,7 cm. Stavba 1, kv. 666/C1, SE 06. Inv. št. 22815.

7. Železen predmet; železo; pr. 4 cm. Stavba 1, kv. 666/C2, SE 34. Inv. št. 22486.

8. Železen predmet; železo; d. pribl. 17,5 cm. Stavba 1, kv. 619/B1, SE 34. Inv. št. 22491.

9. Ploščica; svinec; pr. 1 cm. Stavba 1, kv. 716/D1. Inv. št. 22449.

10. Ploščica; svinec; pr. 1,3 cm. Stavba 1, kv. 720/A3, SE 06. Inv. št. 22830.

11. Utež; svinec; d. 0,7, š. 0,5 cm, m. 1,25 g. Stavba 1, kv. 666/B1, SE 34. Inv. št. 22430.

12. Železen predmet; železo; d. 7,7 cm. Stavba 1, kv. 669/C3, SE 06. Inv. št. 22470.

13. Kresilo; železo; d. 3 cm. Stavba 1, kv. 718/C4/B4, SE 11. Inv. št. 22355.

14. Orodje; železo; d. 12,6 cm. Stavba 1, kv. 870/B2. Detektorska najdba. Inv. št. 22866.

Tabla 29

1. Kladio; železo; d. 16,3 cm. Stavba 1. Detektorska najdba. Inv. št. 23118.

– Ciglencečki 1994b, t. 3: 3.

2. Kladio; železo; d. 14 cm. Stavba 1. Detektorska najdba. Inv. št. 22579.

– Ciglencečki 1994b, t. 4: 1.

3. Kopača; železo; d. 15,2 cm. Stavba 1. Detektorska najdba. Inv. št. 22581.

– Ciglencečki 1994b, t. 3: 4.

4. Naprstnik; bron. Stavba 1. Detektorska najdba. Založen.

– Ciglencečki 1994b, t. 2: 10.

5. Gumb; bron. Stavba 1. Detektorska najdba. Založen.

– Ciglencečki 1994b, t. 2: 9.

Tabla 30

1. Zapah; železo; d. 6 cm. Stavba 1, kv. 619/A3, SE 64. Inv. št. 22924.

2. Zapah; železo; d. 6,5 cm. Stavba 1, kv. 870/B1, SE 34. Inv. št. 22770.

3. Zapah; železo; d. 4,4 cm. Stavba 1, kv. 618/A3, SE 34. Inv. št. 22623.

4. Zapah; železo; d. 5,5 cm. Stavba 1, kv. 870/C1, SE 34, 69. Inv. št. 23177.

5. Zapah; železo; d. 8,6 cm. Stavba 1. Detektorska najdba. Inv. št. 23283.

6. Zapah; železo; d. 3,3 cm. Stavba 1, kv. 716/C1, SE 06. Inv. št. 22533.

7. Zapah; železo; d. 6 cm. Stavba 1, kv. 666/A2,A3,B2,B3, SE 34, 29. Inv. št. 22857.

8. Zapah; železo; d. 6,5 cm. Stavba 1, kv. 669/A1, SE 23. Inv. št. 23722.

9. Zapah; železo; d. 4 cm. Stavba 1, kv. 669/A3, SE 24. Inv. št. 23736.

10. Zapah; železo; d. 6,3 cm. Stavba 1, kv. 569/D4, SE 34. Inv. št. 23214.

11. Zapah; bron, železo. Stavba 1. Detektorska najdba. Založen.

– Ciglencečki 1994b, t. 2: 3.

12. Ključ; železo; d. 6 cm. Stavba 1, kv. 817/B2,B3, SE 13. Inv. št. 22834.

13. Ključ; železo; š. 2,9 cm. Stavba 1, kv. 618/D2, SE 34. Inv. št. 22357.

14. Zapah; železo; d. 4,1 cm. Stavba 1, kv. 666/B1, SE 24. Inv. št. 23815.

15. Zapah; železo; d. 7,4 cm. Stavba 1. Detektorska najdba. Inv. št. 23781.

16. Ključ; železo; d. 13,5 cm. Stavba 1, kv. 716/B4, SE 01. Inv. št. 22808.

17. Ključ v obliki prstana; železo; pr. 2,2 cm. Stavba 1, kv. 669/C4, SE 26. Inv. št. 22320.

18. Ključ v obliki prstana; železo; pr. 2,6 cm. Stavba 1, kv. 720, SE 07. Inv. št. 22327.

19. Ključ; železo; d. 11,4 cm. Stavba 1, kv. 668/C1, SE 01. Inv. št. 22360.

20. Ključ; železo; d. 8,6 cm. Stavba 1, kv. 667/D3, SE 24. Inv. št. 22359.

21. Ključ; železo; d. 7,5 cm. Stavba 1, kv. 717/B4, SE 21. Inv. št. 22540.

Tabla 31

1. Ključ; železo; d. 7,5 cm. Stavba 1, kv. 667/A2, SE 01. Inv. št. 22361.
2. Ključ; železo; d. 16 cm. Stavba 1, kv. 619/C4. Inv. št. 22358.
3. Ključ; bron; d. 7,9 cm. Stavba 1. Detektorska najdba. Inv. št. 23109.  
– Ciglencečki 1994a, t. 6: 19; 1994b, t. 2: 1; 1994c, t. 1: 19.
4. Ključ; železo; d. 8,5 cm. Stavba 1, kv. 719/D3, SE 26. Inv. št. 23782.
5. Ključ; bron; d. 8,4 cm. Stavba 1. Detektorska najdba. Inv. št. 23110.  
– Ciglencečki 1994b, t. 2: 2.
6. Ključ; bron; d. 4,5 cm. Stavba 1, kv. 668/B2. Inv. št. 23139.
7. Ključ; bron; v. 3,8 cm. Stavba 1, kv. 766/A1, SE 24. Inv. št. 22800.
8. Ključ; železo; d. 19 cm. Stavba 1, kv. 769. Inv. št. 22547.
9. Ključ; železo; d. 5,3 cm. Stavba 1, kv. 870/C1, SE 56. Inv. št. 23172.
10. Ključ; železo; d. 4 cm. Stavba 1, kv. 666/A2,A3,B2,B3, SE 34. Inv. št. 23188.
11. Ključ; železo; d. 7 cm. Stavba 1, kv. 870/C1, SE 34. Inv. št. 23174.
12. Ključ; železo; d. 3,5 cm. Stavba 1, kv. 618/A2, SE 34. Inv. št. 22625.
13. Del ročaja ključa; železo; d. 2,7 cm. Stavba 1, kv. 666/A2,A3,B2,B3, SE 34. Inv. št. 22848.

Tabla 32

1. Tečaj; železo; d. 3,5 cm. Stavba 1, kv. 618/A3, SE 34. Inv. št. 22890.
2. Okov; bron; d. 5 cm. Stavba 1, kv. 968/A1, SE 34. Inv. št. 22651.
3. Tečaj; železo; d. 4,8 cm. Stavba 1, kv. 666/B1, SE 24. Inv. št. 23814.
4. Okov; železo; d. 5,2 cm. Stavba 1, kv. 666/B1, SE 24. Inv. št. 23813.
5. Tečaj; železo; d. 3,2 cm. Stavba 1, kv. 765/B4, SE 06. Inv. št. 22437.
6. Tečaj; železo; d. 4,6 cm. Stavba 1, kv. 867/D1-D4, SE 34. Inv. št. 22387.
7. Tečaj; železo; d. 2,5 cm. Stavba 1, kv. 867/D2, SE 34. Inv. št. 22390.
8. Tečaj; železo; d. 1,8 cm. Stavba 1, kv. 619/B2, SE 34. Inv. št. 22401.
9. Tečaj; železo; d. 13,5 cm. Stavba 1, kv. 666/B3, SE 56. Inv. št. 22976.
10. Tečaj; železo; d. 4,6 cm. Stavba 1. Detektorska najdba. Inv. št. 22920.
11. Tečaj; železo; d. 5 cm. Stavba 1, kv. 668/B1, SE 26. Inv. št. 22919.
12. Tečaj; železo; d. 6,2 cm. Stavba 1, kv. 668/D1. Inv. št. 22910.
13. Del tečaja; železo; d. 6,2 cm. Stavba 1, kv. 668/C2, SE 26. Inv. št. 23706.
14. Tečaj; železo; d. 9 cm. Stavba 1, kv. 619/A2, SE 34. Inv. št. 22909.
15. Tečaj; železo; d. 4,7 cm. Stavba 1, kv. 668/C3, SE 26. Inv. št. 22942.

16. Tečaj; železo; d. 4,6 cm. Stavba 1, kv. 668/B1, SE 26. Inv. št. 22917.
17. Tečaj; železo; d. 2,4 cm. Stavba 1, kv. 719/D3, SE 04. Inv. št. 23742.
18. Tečaj; železo; d. 7,3 cm. Stavba 1, kv. 668/B1, SE 26. Inv. št. 22917.
19. Tečaj; železo; d. 3,6 cm. Stavba 1, kv. 618/C3, SE 34. Inv. št. 22990.
20. Tečaj; železo; d. 3,7 cm. Stavba 1, kv. 716/D4, SE 23. Inv. št. 23770.
21. Tečaj; železo; d. 6 cm. Stavba 1, kv. 719/D4. Inv. št. 23734.
22. Tečaj; železo; d. 3,7 cm. Stavba 1, kv. 618/B4, SE 06. Inv. št. 23130.

Tabla 33

1. Tečaj; železo; d. enega dela 7 cm. Stavba 1, kv. 717/D4, SE 21. Inv. št. 22525.
2. Ataša; železo; d. 9 cm. Stavba 1, kv. 818/A1, SE 07. Inv. št. 22695.
3. Tečaj; železo; d. 11,8 cm. Stavba 1, kv. 717/D4, SE 17. Inv. št. 22565.
4. Skoba; železo; d. 3,6 cm. Stavba 1, kv. 719/C3, SE 01. Inv. št. 22559.
5. Spona; železo; d. 5 cm. Stavba 1, kv. 666/B3, SE 06. Inv. št. 22698.
6. Spona; železo; d. 4,2 cm. Stavba 1, kv. 716/A4, SE 01. Inv. št. 23284.
7. Spona; železo; d. 5,5 cm. Stavba 1, kv. 669/C1, SE 06. Inv. št. 22404.
8. Spona; železo; d. 2,4 cm. Stavba 1, kv. 968/D2, SE 34. Inv. št. 22971.
9. Spona; železo; d. 3,7 cm. Stavba 1, kv. 668/A2, SE 26. Inv. št. 23244.
10. Del ključavnice; železo; d. 11,5 cm. Stavba 1, kv. 766/B1, SE 24. Inv. št. 23757.
11. Del ključavnice; železo; d. 14 cm. Stavba 1, kv. 717/D4, SE 21. Inv. št. 22567.
12. Tečaj; železo; d. 13 cm. Stavba 1. Slučajna najdba. Inv. št. 22617.

Tabla 34

1. Žebelj; železo; d. 12,7 cm. Stavba 1, kv. 619/C3, SE 34. Inv. št. 23325.
2. Žebelj; železo; d. 12 cm. Stavba 1, kv. 870/C1, SE 34, 69. Inv. št. 23176.
3. Žebelj; železo; d. 8,3 cm. Stavba 1, kv. 818/A2, SE 03. Inv. št. 22532.
4. Žebelj; železo; d. 8,7 cm. Stavba 1, kv. 717/B3, SE 10. Inv. št. 22508.
5. Žebelj; železo; d. 9,5 cm. Stavba 1, kv. 870/C1, SE 34, 69. Inv. št. 23180.
6. Žebelj; železo; d. 8,2 cm. Stavba 1, kv. 817/D2, SE 06. Inv. št. 23272.
7. Žebelj; železo; d. 9,7 cm. Stavba 1, kv. 870/C1, SE 34, 69. Inv. št. 23175.
8. Žebelj; železo; d. 15,3 cm. Stavba 1, kv. 619/B3, SE 67. Inv. št. 22600.

9. Žebelj; železo; d. 10,4 cm. Stavba 1, kv. 619/C3, SE 34. Inv. št. 23324.  
 10. Žebelj; železo; d. 11 cm. Stavba 1. Slučajna najdba. Inv. št. 22903.  
 11. Žebelj; železo. Stavba 1, kv. 717/A2/A3, SE 08. Inv. št. 22587.  
 12. Žebelj; železo; d. 2,8 cm. Stavba 1, kv. 666/D1, SE 29. Inv. št. 22945.  
 13. Žebelj; železo; d. 6,7 cm. Stavba 1, kv. 716/C1, SE 06. Inv. št. 22708.  
 14. Žebelj; železo; d. 7,2 cm. Stavba 1, kv. 666/C4, SE 06. Inv. št. 22743.  
 15. Žebelj; železo; d. 5,2 cm. Stavba 1, kv. 870/D1, SE 69. Inv. št. 22253.  
 16. Žebelj; železo; d. 2,5 cm. Stavba 1, kv. 666/A3, SE 56. Inv. št. 22255.  
 17. Žebelj; železo; d. 4,8 cm. Stavba 1, kv. 968/C2, SE 34. Inv. št. 23346.  
 18. Žebelj; železo; d. 4,2 cm. Stavba 1, kv. 669/D1, SE 07. Inv. št. 23260.  
 19. Žebelj; železo; 7,6 cm. Stavba 1, kv. 619/B1, SE 34. Inv. št. 23354.

Tabla 35

1. Žebelj; železo; d. 8 cm. Stavba 1, kv. 716/D2, SE 24. Inv. št. 23785.  
 2. Žebelj; železo; d. 6 cm. Stavba 1, kv. 917/D2, SE 34. Inv. št. 22580.  
 3. Žebelj; železo; d. 10 cm. Stavba 1, kv. 668/D3, SE 29. Inv. št. 23760.  
 4. Žebelj; železo; d. 9 cm. Stavba 1, kv. 719/C4. Inv. št. 23725.  
 5. Žebelj; železo; d. 6,5 cm. Stavba 1, kv. 669/C2, SE 24. Inv. št. 23774.  
 6. Žebelj; železo; d. 6,2 cm. Stavba 1, kv. 666/A4, SE 24. Inv. št. 23790.  
 7. Žebelj; železo; d. 5,5 cm. Stavba 1, kv. 668/C1, SE 26. Inv. št. 23702.  
 8. Žebelj; železo; d. 6 cm. Stavba 1, kv. 666/A2,A3,B2,B3, SE 34. Inv. št. 23185.  
 9. Žebelj; železo; d. 6,8 cm. Stavba 1, kv. 666/A1, SE 29. Inv. št. 23223.  
 10. Žebelj; železo; d. 6,8 cm. Stavba 1, kv. 667/B2, SE 23. Inv. št. 22664.  
 11. Žebelj; železo; d. 2,4 cm. Stavba 1, kv. 669/A3,A4,B3,B4, SE 24. Inv. št. 22985.  
 12. Žebelj; železo; d. 4 cm. Stavba 1, kv. 870/C1, SE 34, 69. Inv. št. 23170.  
 13. Žebelj; železo; d. 5 cm. Stavba 1, kv. 669/B1, SE 29. Inv. št. 23795.  
 14. Žebelj; železo; d. 5 cm. Stavba 1, kv. 716/C2, SE 03. Inv. št. 23794.  
 15. Žebelj; železo; d. 5 cm. Stavba 1, kv. 666/A1. Inv. št. 23193.  
 16. Žebelj; železo; d. 4,6 cm. Stavba 1, kv. 666/A2,A3,B2,B3, SE 24, 29. Inv. št. 22856.  
 17. Žebelj; železo; d. 3,6 cm. Stavba 1, kv. 619/A2, SE 34. Inv. št. 22259.  
 18. Žebelj; železo; d. 5,6 cm. Stavba 1, kv. 668/C3, SE 26. Inv. št. 22940.

19. Žebelj; železo; d. 5,4 cm. Stavba 1, kv. 817/D 2. Inv. št. 22534.  
 20. Žebelj; železo; d. 4,9 cm. Stavba 1, kv. 618/C3, SE 34. Inv. št. 22987.  
 21. Žebelj; železo; d. 4,4 cm. Stavba 1, kv. 716/D2. Inv. št. 22907.  
 22. Žebelj; železo; d. 5,8 cm. Stavba 1, kv. 666/A2,A3,B2,B3, SE 34. Inv. št. 23186.  
 23. Žebelj; železo; d. 5,4 cm. Stavba 1, kv. 817/D2, SE 03. Inv. št. 23274.  
 24. Žebelj; železo; d. 4,5 cm. Stavba 1, kv. 666/B2, C2. Inv. št. 22863.

Tabla 36

1. Žebelj; železo; d. 2,4 cm. Stavba 1, kv. 819, SE 34. Inv. št. 23211.  
 2. Žebelj; železo; d. 2,5 cm. Stavba 1, kv. 819, SE 34. Inv. št. 23212.  
 3. Žebelj; železo; d. 3 cm. Stavba 1, kv. 666/A1, A2, SE 34. Inv. št. 23194.  
 4. Žebelj; železo; d. 2,8 cm. Stavba 1, kv. 569/C2, SE 34. Inv. št. 23195.  
 5. Žebelj; železo; d. 3,3 cm. Stavba 1, kv. 767/C1, SE 10. Inv. št. 23292.  
 6. Žebelj; železo; d. 2 cm. Stavba 1, kv. 917/C3,C4,D3,D4, SE 34. Inv. št. 23352.  
 7. Žebelj; železo; d. 2 cm. Stavba 1, kv. 718/B1, SE 10. Inv. št. 23236.  
 8. Žebelj; železo; d. 3 cm. Stavba 1, kv. 618/B4. Inv. št. 23238.  
 9. Žebelj; železo; d. 2 cm. Stavba 1, kv. 716/A1, SE 06. Inv. št. 23240.  
 10. Žebelj; železo; d. 4,9 cm. Stavba 1, kv. 716/B1, SE 06. Inv. št. 23241.  
 11. Žebelj; železo; d. 3,1 cm. Stavba 1, kv. 666/C2, SE 50. Inv. št. 22960.  
 12. Žebelj; železo; d. 2,3 cm. Stavba 1, kv. 666/D1,C1,C2,B2,B3,A3, SE 34. Inv. št. 22973.  
 13. Žebelj; železo; d. 3,5 cm. Stavba 1, kv. 618/A2, A3, SE 34. Inv. št. 23339.  
 14. Žebelj; železo; d. 2 cm. Stavba 1, kv. 619/D1, SE 34. Inv. št. 23338.  
 15. Žebelj; železo; d. 3,4 cm. Stavba 1, kv. 619/D2, SE 34. Inv. št. 23360.  
 16. Žebelj; železo; d. 3,4 cm. Stavba 1, kv. 668/A1/A2, SE 26. Inv. št. 23266.  
 17. Žebelj; železo; d. 2,3 cm. Stavba 1, kv. 717/B4, SE 08. Inv. št. 23270.  
 18. Žebelj; železo; d. 3 cm. Stavba 1, kv. 666/A3, SE 29. Inv. št. 23198.  
 19. Žebelj; železo; d. 2,2 cm. Stavba 1, kv. 666/a3, SE 29. Inv. št. 23199.  
 20. Žebelj; železo; d. 2,4 cm. Stavba 1, kv. 818/B3, SE 07. Inv. št. 23253.  
 21. Žebelj; železo; d. 3,2 cm. Stavba 1, kv. 968/C1, SE 34. Inv. št. 23349.  
 22. Žebelj; železo; d. 3,4 cm. Stavba 1, kv. 669, SE 29a. Inv. št. 23806.  
 23. Žebelj; železo; d. 2,9 cm. Stavba 1, kv. 816/A1, SE 24. Inv. št. 23754.

24. Žebelj; železo; d. 1,9 cm. Stavba 1, kv. 819/A4, B1–B4, D1, C1, SE 34. Inv. št. 22263.  
 25. Žebelj; železo; d. 3,7 cm. Stavba 1, kv. 767/A2, SE 10. Inv. št. 22696.  
 26. Žebelj; železo; d. 2,6 cm. Stavba 1, kv. 618/D1, D2, SE 34. Inv. št. 23331.  
 27. Žebelj; železo; d. 2,9 cm. Stavba 1, kv. 618/D1, D2, SE 34. Inv. št. 23332.  
 28. Žebelj; železo; d. 1,4 cm. Stavba 1, kv. 716/B2, SE 23. Inv. št. 23753.  
 29. Žebelj; železo; d. 2 cm. Stavba 1, kv. 618/A3, SE 34. Inv. št. 22681.  
 30. Žebelj; železo; d. 1,7 cm. Stavba 1, kv. 666/C3. Inv. št. 22946.  
 31. Žebelj; železo; d. 1,6 cm. Stavba 1, kv. 569/D4, SE 34. Inv. št. 23215.  
 32. Žebelj; železo; d. 3,1 cm. Stavba 1, kv. 668/C3, SE 26. Inv. št. 22943.  
 33. Žebelj; železo; d. 1,8 cm. Stavba 1, kv. 666/A2, A3, B2, B3, SE 34. Inv. št. 23187.  
 34. Žebelj; železo; pr. 2,5 cm. Stavba 1, kv. 719/C3. Inv. št. 23261.  
 35. Žebelj; železo; d. 2,1 cm. Stavba 1, kv. 669/C2, SE 24. Inv. št. 23777.  
 36. Žebelj; železo; d. 1 cm. Stavba 1, kv. 618/D1, D2, SE 34. Inv. št. 23330.  
 37. Žebelj; železo; d. 1,2 cm. Stavba 1, kv. 769/A1, SE 07. Inv. št. 23264.  
 38. Žebelj; železo; d. 1,4 cm. Stavba 1, kv. 592/C2. Inv. št. 22951.  
 39. Žebelj; železo; pr. 1 cm. Stavba 1, kv. 669/C1, SE 07. Inv. št. 22243.  
 40. Žebelj; železo; d. 1,4 cm. Stavba 1, kv. 666/B1, SE 29. Inv. št. 22765.  
 41. Žebelj; železo; v. 0,9 cm. Stavba 1, kv. 867/C2. Inv. št. 22733.

*Tabla 37*

1. Žebelj; železo; d. 4,1 cm. Stavba 1, kv. 668/D1, SE 26. Inv. št. 23759.  
 2. Žebelj; železo; d. cm 4. Stavba 1, kv. 668/B1, SE 26. Inv. št. 23812.  
 3. Žebelj; železo; d. 4 cm. Stavba 1, kv. 817/B3, SE 10. Inv. št. 23787.  
 4. Žebelj; železo; d. 5 cm. Stavba 1, kv. 669/A2, SE 29. Inv. št. 23684.  
 5. Žebelj; železo; d. 6 cm. Stavba 1, kv. 669/C2, SE 24. Inv. št. 23773.  
 6. Žebelj; železo; d. 5,5 cm. Stavba 1, kv. 666/A3, SE 29. Inv. št. 23200.  
 7. Žebelj; železo; d. 4 cm. Stavba 1, kv. 666/A1, SE 29. Inv. št. 23222.  
 8. Žebelj; železo; d. 3,8 cm. Stavba 1, kv. 669/C2, SE 24. Inv. št. 23775.  
 9. Žebelj; železo; d. 3,2 cm. Stavba 1, kv. 766/B2, SE 24. Inv. št. 23687.  
 10. Žebelj; železo; d. 7,7 cm. Stavba 1, kv. 968/C2, SE 34. Inv. št. 23347.  
 11. Žebelj; železo; d. 4,8 cm. Stavba 1, kv. 669/A3, A4, B3, B4, SE 29a. Inv. št. 22969.

12. Žebelj; železo; d. 6 cm. Stavba 1, kv. 870/C1, SE 34, 69. Inv. št. 23181.  
 13. Žebelj; železo; d. 2,1 cm. Stavba 1, kv. 716/B2, SE 68. Inv. št. 23709.  
 14. Žebelj; železo; d. 3,3 cm. Stavba 1, kv. 669/B1, SE 26. Inv. št. 23818.  
 15. Žebelj; železo; d. 3,2 cm. Stavba 1, kv. 669/A1, SE 23. Inv. št. 23732.  
 16. Žebelj; železo; d. 2,7 cm. Stavba 1, kv. 766/A3, SE 24. Inv. št. 23713.  
 17. Žebelj; železo; d. 3,3 cm. Stavba 1, kv. 716/C1, SE 04. Inv. št. 23716.  
 18. Žebelj; železo; d. 1,8 cm. Stavba 1, kv. 716/C1, SE 04. Inv. št. 23717.  
 19. Žebelj; železo; d. 4 cm. Stavba 1, kv. 716/B3, SE 24. Inv. št. 23728.  
 20. Žebelj; železo; d. 3 cm. Stavba 1, kv. 669/D2, SE 28. Inv. št. 23730.  
 21. Žebelj; železo; d. 2,2 cm. Stavba 1, kv. 719/B4, SE 05. Inv. št. 23740.  
 22. Žebelj; železo; d. 2,8 cm. Stavba 1, kv. 669/D3, SE 30. Inv. št. 23692.  
 23. Žebelj; železo; d. 2,6 cm. Stavba 1, kv. 669/D3, SE 30. Inv. št. 23693.  
 24. Žebelj; železo; d. 4 cm. Stavba 1, kv. 669/A1, SE 29. Inv. št. 23696.  
 25. Žebelj; železo; d. 3,2 cm. Stavba 1, kv. 669/A1, SE 29. Inv. št. 23697.  
 26. Žebelj; železo; d. 2,6 cm. Stavba 1, kv. 668/D3, SE 24. Inv. št. 23703.  
 27. Žebelj; železo; d. 4,1 cm. Stavba 1, kv. 937, SE 06. Inv. št. 23271.  
 28. Žebelj; železo; d. 3,3 cm. Stavba 1, kv. 719/A1. Inv. št. 23711.  
 29. Okov in žebelj; železo; d. 4 cm. Stavba 1, kv. 668/C1, SE 26. Inv. št. 23699.  
 30. Žebelj; železo; d. 2,6 cm. Stavba 1, kv. 669/C2, SE 24. Inv. št. 23776.  
 31. Žebelj; železo; d. 2,4 cm. Stavba 1, kv. 669/A1, SE 29. Inv. št. 23698.  
 32. Žebelj; železo; d. 2 cm. Stavba 1, kv. 668/C1, SE 26. Inv. št. 23700.  
 33. Žebelj; železo; d. 3,3 cm. Stavba 1, kv. 668/C1, SE 26. Inv. št. 23701.

*Tabla 38*

1. Žebelj; železo; d. 3,7 cm. Stavba 1, kv. 766/A1, SE 01. Inv. št. 23294.  
 2. Žebelj; železo; d. 3 cm. Stavba 1, kv. 870/D2, SE 69. Inv. št. 22254.  
 3. Žebelj; železo; d. 3 cm. Stavba 1, kv. 867/C4, SE 60. Inv. št. 22908.  
 4. Žebelj; železo; pr. 2,6 cm. Stavba 1, kv. 769/B2, SE 06. Inv. št. 22507.  
 5. Žebelj; železo; d. 4,9 cm. Stavba 1, kv. 716/B1, SE 06. Inv. št. 22718.  
 6. Žebelj; železo; d. 4,9 cm. Stavba 1, kv. 919/D2, D3. Inv. št. 22607.  
 7. Žebelj; železo; d. 4 cm. Stavba 1, kv. 768/B1. Inv. št. 22549.

8. Žebelj; železo; d. 3 cm. Stavba 1, kv. 815/D3, SE 14. Inv. št. 23248.
9. Žebelj; železo; d. 5,2 cm. Stavba 1, kv. 870/B1, SE 34. Inv. št. 22772.
10. Žebelj; železo; d. 2,1 cm. Stavba 1, kv. 669/C2, SE 24. Inv. št. 23777.
11. Žebelj; železo; d. 3,7 cm. Stavba 1, kv. 767/B4, SE 16. Inv. št. 22558.
12. Žebelj; železo; d. 2,8 cm. Stavba 1, kv. 767/B1, SE 10. Inv. št. 22780.
13. Žebelj; železo; d. 4,4 cm. Stavba 1, kv. 666/D3, SE 06. Inv. št. 22244.
14. Žebelj; železo; d. 3 cm. Stavba 1, kv. 669/C2, SE 06. Inv. št. 22287.
15. Žebelj; železo; d. 3,7 cm. Stavba 1, kv. 815/D3, SE 14. Inv. št. 23249.
16. Žebelj; železo; d. 1,4 cm. Stavba 1. Slučajna najdba. Inv. št. 22757.
17. Žebelj; železo; d. 4,9 cm. Stavba 1, kv. 816/D2, SE 09. Inv. št. 22516.
18. Žebelj; železo; d. 5 cm. Stavba 1, kv. 666/B3, SE 50. Inv. št. 22251.
19. Žebelj; železo; d. 3,1 cm. Stavba 1, kv. 867/C2. Inv. št. 22731.
20. Žebelj; železo; d. 3,5 cm. Stavba 1, kv. 666/A2, SE 56. Inv. št. 22414.
21. Žebelj; železo; d. 3 cm. Stavba 1, kv. 767/C2, SE 10. Inv. št. 23267.
22. Žebelj; železo; d. 4,8 cm. Stavba 1, kv. 816/D2, SE 12. Inv. št. 22588.
23. Žebelj; železo; d. 5,2 cm. Stavba 1, kv. 667/B1, SE 06. Inv. št. 22246.
24. Žebelj; železo; d. 4,4 cm. Stavba 1, kv. 919/A1, SE 34. Inv. št. 22898.
25. Žebelj; železo; d. 2,5 cm. Stavba 1, kv. 669/C4, SE 34. Inv. št. 22255.
26. Žebelj; železo; d. 3,1 cm. Stavba 1, kv. 720, SE 07. Inv. št. 22328.
27. Žebelj; železo; d. 2,2 cm. Stavba 1, kv. 868/D2. Inv. št. 22720.
28. Žebelj; železo; d. 2,4 cm. Stavba 1, kv. 666/C3. Inv. št. 22789.
29. Žebelj; železo; d. 5,5 cm. Stavba 1, kv. 817. Inv. št. 23356.
30. Žebelj; železo; d. 3,6 cm. Stavba 1, kv. 867, SE 05. Inv. št. 22248.
31. Žebelj; železo; d. 3,4 cm. Stavba 1, kv. 624, SE 06. Inv. št. 22709.
32. Žebelj; železo; d. 4 cm. Stavba 1, kv. 618/C2, SE 34. Inv. št. 22665.
33. Žebelj; železo; d. 3,4 cm. Stavba 1, kv. 666/A3, SE 56. Inv. št. 22257.
34. Žebelj; železo; d. 5,5 cm. Stavba 1, kv. 766/A2, SE 01. Inv. št. 23239.
35. Žebelj; železo; pr. 2,2 cm. Stavba 1, kv. 816/C1, SE 09. Inv. št. 22501.
2. Žebelj; železo; d. 1,3cm. Stavba 1, kv. 817, SE 03. Inv. št. 22641.
3. Žebelj; železo; d. 1,5 cm. Stavba 1, kv. 766/A2, SE 23. Inv. št. 22706.
4. Žebelj; železo; d. 0,7 cm. Stavba 1, kv. 968/A1-4, SE 34. Inv. št. 23341.
5. Žebelj; železo; d. 1,3 cm. Stavba 1, kv. 868/A3. Inv. št. 22676.
6. Žebelj; železo; d. 0,7 cm. Stavba 1, kv. 619/A1. Inv. št. 22660.
7. Žebelj; železo; d. 1,4 cm. Stavba 1, kv. 669/B1, SE 29. Inv. št. 23796.
8. Žebelj; železo; d. 1,1 cm. Stavba 1, kv. 817/C3, D3, SE 03. Inv. št. 22518.
9. Žebelj; železo; d. 1,3 cm. Stavba 1, kv. 667/D4, SE 01. Inv. št. 22247.
10. Žebelj; železo; d. 1 cm. Stavba 1, kv. 766/A4, SE 01. Inv. št. 22249.
11. Žebelj; železo; v. 1,4 cm. Stavba 1, kv. 668/D2, SE 29. Inv. št. 23739.
12. Žebelj; železo; d. 1,7 cm. Stavba 1, kv. 666/A1/B1, SE 06. Inv. št. 23246.
13. Žebelj; železo; d. 1,8 cm. Stavba 1, kv. 668/D1, SE 01. Inv. št. 23252.
14. Žebelj; železo; d. 1,3 cm. Stavba 1, kv. 767/C1, SE 10. Inv. št. 23291.
15. Žebelj; železo; d. 1,5 cm. Stavba 1, kv. 666/A1/B1, SE 06. Inv. št. 23245.
16. Žebelj; železo; d. 1,2 cm. Stavba 1, kv. 766/A1, SE 24. Inv. št. 23801.
17. Žebelj; železo; d. 1,3 cm. Stavba 1, kv. 719/B1, SE 07. Inv. št. 23804.
18. Žebelj; železo; d. 1,2 cm. Stavba 1, kv. 819/B1-B4,A4,D1,C1, SE 34. Inv. št. 22262.
19. Žebelj; železo; d. 1 cm. Stavba 1, kv. 666/C2, SE 56. Inv. št. 22953.
20. Žebelj; železo; d. 1,1 cm. Stavba 1, kv. 867/A1, SE 06. Inv. št. 22712.
21. Žebelj; železo; d. 1,6 cm. Stavba 1, kv. 817. Inv. št. 22654.
22. Žebelj; železo; d. 1,4 cm. Stavba 1, kv. 619/A1, SE 34. Inv. št. 22657.
23. Žebelj; železo; d. 0,9 cm. Stavba 1, kv. 817/B3, SE 13. Inv. št. 22649.
24. Žebelj; železo; d. 1,5 cm. Stavba 1, kv. 668/D1, SE 24. Inv. št. 23743.
25. Žebelj; železo; d. 1,5 cm. Stavba 1, kv. 716/A2, SE 68. Inv. št. 23744.
26. Žebelj; železo; d. 1,6 cm. Stavba 1, kv. 669/A3,A4,B3,B4. Inv. št. 22981.
27. Žebelj; železo; d. 1,5 cm. Stavba 1, kv. 666/A2,A3,B2,B3, SE 34, 29. Inv. št. 22847.
28. Žebelj; železo; d. 1,3 cm. Stavba 1, kv. 817. Inv. št. 22655.
29. Žebelj; železo; v. 4,7 cm. Stavba 1, kv. 619/C3, SE 34. Inv. št. 22224.
30. Žebelj; železo; d. 1,1 cm. Stavba 1, kv. 666/B1, SE 29. Inv. št. 22766.
31. Žebelj; železo; d. 1,4 cm. Stavba 1, kv. 768/C3,D3, SE 03. Inv. št. 22635.
32. Žebelj; železo; d. 1 cm. Stavba 1, kv. 817/B3, SE 13. Inv. št. 22634.
33. Žebelj; železo; d. 1,2 cm. Stavba 1, kv. 817/B3, SE 13. Inv. št. 22619.

*Tabla 39*

1. Žebelj; železo; d. 1,2 cm. Stavba 1, kv. 868/vsi, SE 34. Inv. št. 22967.

34. Žebelj; železo; d. 1,3 cm. Stavba 1, kv. 817/B3, SE 13. Inv. št. 22618.
35. Žebelj; železo; d. 1,2 cm. Stavba 1, kv. 817/B2/3, SE 03. Inv. št. 22519.
36. Žebelj; železo; d. 1,3 cm. Stavba 1, kv. 619/C2, SE 74. Inv. št. 22906.
37. Žebelj; železo; d. 1,5 cm. Stavba 1, kv. 867/C2. Inv. št. 22732.
38. Žebelj; železo; d. 1 cm. Stavba 1, kv. 666/C2, SE 56. Inv. št. 22954.
39. Žebelj; železo; d. 0,8 cm. Stavba 1, kv. 669/D3, SE 30. Inv. št. 23694.
40. Žebelj; železo; d. 1 cm. Stavba 1. Slučajna najdba. Inv. št. 22904.
41. Žebelj; železo; d. 1 cm. Stavba 1, kv. 817/A3. Inv. št. 22785.
42. Žebelj; železo; d. 0,9 cm. Stavba 1, kv. 666/B1, SE 29. Inv. št. 22767.
43. Žebelj; železo; d. 1,1cm. Stavba 1, kv. 768/C3,D3, SE 03. Inv. št. 22636.
44. Žebelj; železo; d. 1,2 cm. Stavba 1, kv. 669/C4, SE 34. Inv. št. 22252.
45. Žebelj; železo; d. 1,5 cm. Stavba 1, kv. 666/B2,C2. Inv. št. 22860.
46. Žebelj; železo; d. 1,2 cm. Stavba 1, kv. 568/B4, SE 34. Inv. št. 22931.
47. Žebelj; železo; d. 1,6 cm. Stavba 1, kv. 666/B3, SE 56. Inv. št. 23793.
48. Žebelj; železo; d. 1,5 cm. Stavba 1, kv. 619/C3, SE 68. Inv. št. 23191.
49. Žebelj; železo; d. 1,2 cm. Stavba 1, kv. 668/C2. Inv. št. 23788.
50. Žebelj; železo; d. 1 cm. Stavba 1, kv. 669/A2, SE 29. Inv. št. 23686.
51. Žebelj; železo; d. 1,3 cm. Stavba 1, kv. 817/B3, SE 13. Inv. št. 22648.
52. Žebelj; železo; d. 1,2 cm. Stavba 1, kv. 817/B3, SE 13. Inv. št. 22647.
53. Žebelj; železo; d. 1 cm. Stavba 1, kv. 817, SE 03. Inv. št. 22642.
54. Žebelj; železo; d. 1,2 cm. Stavba 1, kv. 768/D3. Inv. št. 22637.
55. Žebelj; železo; d. 2,1 cm. Stavba 1, kv. 666/C4, SE 24. Inv. št. 23789.
56. Žebelj; železo; d. 1,5 cm. Stavba 1, kv. 718/C1, SE 02. Inv. št. 23279.
57. Žebelj; železo; d. 1,1 cm. Stavba 1, kv. 870/C2, SE 73. Inv. št. 23208.
58. Žebelj; železo; d. 1 cm. Stavba 1, kv. 569/C1, SE 34. Inv. št. 23234.
59. Žebelj; železo; d. 1,2 cm. Stavba 1, kv. 569/D3, SE 34. Inv. št. 23207.
60. Žebelj; železo; d. 1 cm. Stavba 1, kv. 666/B2, SE 56. Inv. št. 23227.
61. Žebelj; železo; d. 1 cm. Stavba 1, kv. 666/B1, SE 03. Inv. št. 23203.
62. Žebelj; železo; d. 1,3 cm. Stavba 1, kv. 619/B3,C3, SE 68. Inv. št. 23233.
63. Žebelj; železo; d. 1,6 cm. Stavba 1, kv. 666/A2, SE 56. Inv. št. 23204.
64. Žebelj; železo; d. 1,1 cm. Stavba 1, kv. 717/A1, SE 01. Inv. št. 23268.
65. Žebelj; železo; d. 2,4 cm. Stavba 1, kv. 768. Inv. št. 23242.
66. Žebelj; železo; d. 1 cm. Stavba 1, kv. 819, SE 34. Inv. št. 23213.
67. Žebelj; železo; d. 1 cm. Stavba 1, kv. 769/A2, SE 03. Inv. št. 23276.
68. Žebelj; železo; d. 1,1 cm. Stavba 1, kv. 667/C2, SE 01. Inv. št. 23277.
69. Žebelj; železo; d. 1 cm. Stavba 1, kv. 817/A3, SE 03. Inv. št. 23278.
70. Žebelj; železo; d. 1,5 cm. Stavba 1, kv. 867/C1, SE 03. Inv. št. 23273.
71. Žebelj; železo; d. 1,1 cm. Stavba 1, kv. 817/D4, SE 03. Inv. št. 23275.
72. Žebelj; železo; d. 1,3 cm. Stavba 1, kv. 769/D1, SE 03. Inv. št. 23225.
73. Žebelj; železo; d. 1,5 cm. Stavba 1, kv. 769/C3, SE 06. Inv. št. 22242.
74. Žebelj; železo; d. 1,4 cm. Stavba 1, kv. 666/A2,A3,B2,B3, SE 34, 29. Inv. št. 23039.
75. Žebelj; železo; d. 1,4 cm. Stavba 1, kv. 817/A1/A2. Inv. št. 23265.
76. Žebelj; železo; pr. 3,5 cm. Stavba 1, kv. 870/C1, SE 34, 69. Inv. št. 23169.
77. Žebelj; železo; pr. 3,6 cm. Stavba 1, kv. 768/B3. Inv. št. 22673.

*Tabla 40*

1. Žebelj; železo; d. 0,9 cm. Stavba 1, kv. 868/B1. Inv. št. 22939.
2. Žebelj; železo; d. 1,3 cm. Stavba 1, kv. 968/D1, SE 34. Inv. št. 22608.
3. Žebelj; železo; d. 1,5 cm. Stavba 1, kv. 666/B2, SE 56. Inv. št. 23220.
4. Žebelj; železo; d. 1 cm. Stavba 1, kv. 766/A1, SE 24. Inv. št. 23800.
5. Spojka; železo; d. 2,4 cm. Stavba 1, kv. 666/C4, SE 06. Inv. št. 22742.
6. Pinceta; bron; d. 5,5 cm. Stavba 1, kv. 716/B1, SE 23. Inv. št. 22479.
7. Pinceta; bron; d. 5,8 cm. Stavba 1, kv. 669/A4, SE 23. Inv. št. 22631.
8. Pinceta; železo; d. 6,8 cm. Stavba 1, kv. 917/B1, SE 34. Inv. št. 22922.
9. Pinceta; železo; d. 6,7 cm. Stavba 1, kv. 666/C2, SE 34. Inv. št. 22365.
10. Ogledalo?; bron; d. 2 cm. Stavba 1, kv. 868/C1. Inv. št. 23148.
11. Glavnik; rogovina, železo; d. 9,9 cm. Stavba 1, kv. 717/B3, SE 36. Inv. št. 22384.
12. Glavnik; rogovina; d. 8 cm. Stavba 1, kv. 718/B4, SE 36. Inv. št. 23365.
13. Glavnik; rogovina, železo; d. 4,2 cm. Stavba 1, kv. 719/C2, SE 26. Inv. št. 22428.
14. Glavnik; rogovina, železo; d. 3 cm. Stavba 1, kv. 669/D2, SE 03. Inv. št. 22483.
15. Glavnik; rogovina; d. 2 cm. Stavba 1, kv. 768/B1, SE 21. Inv. št. 23366.
16. Glavnik; rogovina, železo; d. 1,6 cm. Stavba 1, kv. 816/D1, SE 03. Inv. št. 23756.
17. Glavnik; rogovina, bron; d. 3 cm. Stavba 1, kv. 666/C3, SE 50. Inv. št. 23373.

18. Glavnik; rogovina; d. 3 cm. Stavba 1, kv. 767/A1, SE 36. Inv. št. 23376.  
 19. Glavnik; rogovina; d. 3,6 cm. Stavba 1, kv. 768/B1. Inv. št. 23375.  
 20. Glavnik; rogovina; d. 1,5 cm. Stavba 1, kv. 717/D3, SE 29a. Inv. št. 23377.  
 21. Glavnik; rogovina; d. 0,7 cm. Stavba 1, kv. 669/B3, SE 29 A. Inv. št. 23084.  
 22. Glavnik; rogovina; d. 4 cm. Stavba 1, kv. 666/B2,C2, SE 34. Inv. št. 23370.  
 23. Glavnik; rogovina; d. 6,1 cm. Stavba 1, kv. 666/B3, SE 29. Inv. št. 23367.  
 24. Glavnik; rogovina; d. 4,1 cm. Stavba 1, kv. 666/B2,C2, SE 34. Inv. št. 23371.  
 25. Glavnik; rogovina; d. 2,1 cm. Stavba 1, kv. 666/B1, SE 29. Inv. št. 23369.  
 26. Glavnik; rogovina; d. 1,7 cm. Stavba 1, kv. 666/B3, SE 29. Inv. št. 23368.  
 27. Glavnik; rogovina; d. 2,4 cm. Stavba 1, kv. 666/B2,C2, SE 34. Inv. št. 23372.

Tabla 41

1. Ročaj; bron; d. 16 cm. Stavba 1, kv. 666/C1, SE 50. Inv. št. 22340.  
 2. Ataša; bron; d. 5,4 cm. Stavba 1, kv. 921, SE 34. Inv. št. 22495.  
 3. Ataša; bron; d. 4,3 cm. Stavba 1, kv. 668/A2, SE 01. Inv. št. 22796.  
 4. Bronast predmet; bron; d. 2,3 cm. Stavba 1, kv. 816/D4, SE 01. Inv. št. 22397.  
 5. Noga posode; bron; d. 2,1 cm. Stavba 1, kv. 918/C3, SE 34. Inv. št. 22333.  
 6. Dno posode; bron; pr. 4,4cm. Stavba 1. Detektorska najdba. Inv. št. 22817.  
 7. Pločevina; bron; d. 3,5 cm. Stavba 1, kv. 569/D1, SE 34. Inv. št. 23159.  
 8. Ročaj; bron; d. 3,2 cm. Stavba 1, kv. 766/A2, SE 06. Inv. št. 22811.  
 9. Pločevina; bron; d. 7,5 cm. Stavba 1, kv. 666/B4, SE 23. Inv. št. 22218.  
 10. Pločevina; bron; d. 7,3 cm. Stavba 1, kv. 716/D1, SE 03. Inv. št. 22838.  
 11. Pločevina; bron; d. 3 cm. Stavba 1, kv. 666/D2, SE 23. Inv. št. 23136.  
 12. Pločevina; bron; d. 5 cm. Stavba 1, kv. 769/B3. Inv. št. 23126.  
 13. Pločevina; bron; d. 5 cm. Stavba 1, kv. 719/C2, SE 26. Inv. št. 23119.  
 14. Pločevina; bron; d. 8,4 cm. Stavba 1, kv. 817/D2, SE 63. Inv. št. 23385.  
 15. Pločevina; bron; d. 1,8 cm. Stavba 1, kv. 817/A1,A2. Inv. št. 22812.  
 16. Pločevina; bron; d. 2,1 cm. Stavba 1, kv. 669/C4, SE 01. Inv. št. 22810.  
 17. Pločevina; bron; d. 4,6 cm. Stavba 1, kv. 719/B1, SE 26. Inv. št. 23340.  
 18. Pločevina; bron; pr. 1,8cm. Stavba 1, kv. 719/D3, SE 05. Inv. št. 22818.  
 19. Pločevina; bron; d. 2,7 cm. Stavba 1, kv. 667/668, SE 06. Inv. št. 22840.

Tabla 42

1. Pločevina; bron; d. 2,6 cm. Stavba 1, kv. 669/A3,B3,A4,B4, SE 24. Inv. št. 23160.  
 2. Pločevina; bron; d. 1,5 cm. Stavba 1, kv. 669/A3. Inv. št. 23138.  
 3. Pločevina; bron; d. 2 cm. Stavba 1, kv. 666/B2, C2. Inv. št. 23156.  
 4. Pločevina; bron; d. 2,1 cm. Stavba 1, kv. 513/B1. Inv. št. 22883.  
 5. Zakovica; bron; d. 1,1 cm. Stavba 1, kv. 817/A4, SE 01. Inv. št. 23387.  
 6. Pločevina; bron; d. 2 cm. Stavba 1, kv. 619/A1, SE 34. Inv. št. 23157.  
 7. Pločevina; železo; d. 2 cm. Stavba 1, kv. 669/A3,B3,A4,B4, SE 24. Inv. št. 23161.  
 8. Pločevina; bron; d. 3,5 cm. Stavba 1, kv. 619/C3, SE 34. Inv. št. 23151.  
 9. Pločevina; bron; d. 1,9 cm. Stavba 1, kv. 619/B3, SE 64. Inv. št. 23152.  
 10. Pločevina; bron; d. 2 cm. Stavba 1, kv. 867/D1-D4, C2-C4, B3-B4, A4, SE 34. Inv. št. 23153.  
 11. Pločevina; bron; d. 1 cm. Stavba 1, kv. 619/B2, SE 64. Inv. št. 23154.  
 12. Pločevina; bron; d. 2,2 cm. Stavba 1, kv. 667/B4, SE 10. Inv. št. 22807.  
 13. Pločevina; bron; d. 2,9 cm. Stavba 1, kv. 618, 668, SE 06. Inv. št. 22398.  
 14. Pločevina; bron; d. 4,4 cm. Stavba 1, kv. 815/C2. Inv. št. 22793.  
 15. Pločevina; bron; d. 2,7 cm. Stavba 1, kv. 666/B1, SE 29. Inv. št. 22763.  
 16. Pločevina; bron; d. 2,6 cm. Stavba 1, kv. 666/D1, SE 50. Inv. št. 22643.  
 17. Pločevina; bron; d. 1,9 cm. Stavba 1, kv. 669/A3,A4,B3,B4, SE 24. Inv. št. 22803.  
 18. Pločevina; bron; d. 2,8 cm. Stavba 1, kv. 667/B2, SE 23. Inv. št. 22663.  
 19. Pločevina; bron; d. 1,8 cm. Stavba 1, kv. 669/B4, SE 24. Inv. št. 22591.  
 20. Pločevina; bron; d. 2 cm, š. 2,5cm. Stavba 1, kv. 716/B4, SE 24. Inv. št. 22463.  
 21. Pločevina; bron; pr. 2 cm. Stavba 1, kv. 666/B3, SE 29. Inv. št. 23155.  
 22. Pločevina; bron; d. 2,4 cm. Stavba 1, kv. 619/D3, SE 64. Inv. št. 22627.  
 23. Pločevina; bron; d. 3 cm. Stavba 1, kv. 667/B3, B4, SE 08. Inv. št. 22554.  
 24. Pločevina; bron; d. 2 cm. Stavba 1, kv. 666/B3, SE 56. Inv. št. 22632.  
 25. Pločevina; bron; d. 3,8 cm. Stavba 1, kv. 718/B1, SE 10. Inv. št. 22821.  
 26. Pločevina; bron; pr. 1,4 cm. Stavba 1, kv. 666/B1, SE 29. Inv. št. 22764.

Tabla 43

1. Sekira; železo; d. 14,5 cm. Stavba 2, kv. 1178/B2, SE 106. Inv. št. 23513.  
 2. Zapestnica; bron; pr. 4,4 cm. Stavba 2, kv. 1178/B3, SE 106. Inv. št. 23527.

3. Členek verižice; bron; d. 1,8 cm. Stavba 2, kv. 1178, SE 121. Inv. št. 23721.
4. Bronast predmet; bron; d. 2,1 cm. Stavba 2, kv. 1178/A4, SE 106. Inv. št. 23526.
5. Okov; bron; d. 4,6cm. Stavba 2, SE 165. Inv. št. 23564.
6. Orodje; železo; d. 5,7 cm. Stavba 2, kv. 1129/D4, SE 113. Inv. št. 23549.
7. Okov; železo; d. 4,7 cm. Stavba 2, kv. 1128/D3, SE 121. Inv. št. 23555.
8. Okov; železo; d. 5,3 cm. Stavba 2, kv. 1128/D3, SE 106. Inv. št. 23554.
9. Okov; železo; d. 11,5 cm. Stavba 2, kv. 1278/D1, SE 101. Inv. št. 23547.
10. Konica; bron; d. 6,8 cm. Stavba 2, kv. 1178/C4, SE 106. Inv. št. 23529.
11. Orodje; železo; d. 7,2 cm. Stavba 2, kv. 1178/A2, SE 106. Inv. št. 23551.
12. Tečaj; železo; d. 3,7 cm. Stavba 2, kv. 1178/C3, SE 112. Inv. št. 23541.
13. Trak; svinec; d. 2,7 cm. Stavba 2, kv. 1179/A2, SE 106. Inv. št. 23538.
14. Nož; železo; d. 12,6 cm. Stavba 2, kv. 1229/C3, SE 109. Inv. št. 23560.
15. Nož; železo; d. 10 cm. Stavba 2, kv. 1178/B1. Inv. št. 23559.
16. Nož; železo; d. 8,6 cm. Stavba 2, kv. 1229/C4, SE 109. Inv. št. 23556.
17. Nož; železo; d. 15,3 cm. Stavba 2, kv. 1179/B2, SE 106. Inv. št. 23561.
18. Nož; železo; d. 6,6 cm. Stavba 2, kv. 1229/A4. Inv. št. 23558.
19. Nož; železo; d. 6,6cm. Stavba 2, kv. 1128. Inv. št. 23557.

Tabla 44

1. Plošča; železo; pr. 8 cm. Stavba 2, kv. 1179/A2, SE 106. Inv. št. 23548.
2. Kosir; železo; pr. 4 cm. Stavba 2, kv. 1179/A3, SE 106. Inv. št. 23550.
3. Okov; železo; d. 5 cm. Stavba 2, kv. 1178/C3, SE 112. Inv. št. 23543.
4. Žebelj; železo; d. 2,5 cm. Stavba 2, kv. 1178, SE 106. Inv. št. 23522.
5. Žebelj; železo; d. 1,2 cm. Stavba 2, kv. 1128/D2, SE 106. Inv. št. 23518.
6. Zakovica; bron; d. 1,4 cm. Stavba 2, kv. 1177/D1, SE 106. Inv. št. 23524.
7. Žebelj; železo; d. 1,4 cm. Stavba 2, kv. 1128/D2, SE 106. Inv. št. 23517.
8. Trak; svinec; d. 2 cm. Stavba 2, kv. 1178/B1, SE 106. Inv. št. 23533.
9. Trak; svinec; d. 3 cm. Stavba 2, kv. 1178/A3, SE 106. Inv. št. 23532.
10. Žica; bron; d.6,2 cm. Stavba 2, kv. 1177/D1, SE 106. Inv. št. 23523.
11. Trak; svinec; pr. 2,8 cm. Stavba 2, kv. 1178/C3, SE 106. Inv. št. 23823.
12. Trak; svinec; d. 3,3 cm. Stavba 2, kv. 1179/B3, SE 106. Inv. št. 23537.
13. Trak; svinec; d. 3,3 cm. Stavba 2, kv. 1179/A3, SE 106. Inv. št. 23536.

14. Trak; svinec; d. 3,4 cm. Stavba 2, kv. 1178/B4, SE 112. Inv. št. 23535.
15. Trak; svinec; d. 3,4 cm. Stavba 2, kv. 1178/B1, SE 106. Inv. št. 23534.
16. Žebelj; železo; d. 1,1 cm. Stavba 2, kv. 1178/A1, SE 106. Inv. št. 23520.
17. Žebelj; železo; d. 1,6 cm. Stavba 2, kv. 1178/A3, SE 106. Inv. št. 23521.
18. Žebelj; železo; d. 1,3 cm. Stavba 2, kv. 1178/D2, SE 106. Inv. št. 23516.
19. Žebelj; železo; d. 6,8 cm. Stavba 2, kv. 1178/C2, SE 106. Inv. št. 23514.
20. Žebelj; železo; d. 4 cm. Stavba 2, kv. 1128/D3, SE 106. Inv. št. 23515.
21. Žebelj; železo; d. 1,6 cm. Stavba 2, kv. 1178/B1, SE 106. Inv. št. 23519.
22. Nož; železo; d. 14,5 cm. Grob 18, kv. 1279/B3. Inv. št. 23562.  
– Modrijan 2011, sl. 7: 1.
23. Jagoda, svitkasta; steklo; d. 1,3 cm. Grob 18, kv. 1279/B3. Inv. št. 23890, *sl. 2.10: 2.*  
– Modrijan 2011, sl. 7:2.
24. Pasni jeziček; železo; d. 2,5 cm. Grob 18, kv. 1279/B3. Inv. št. 23563.  
– Modrijan 2011, sl. 7: 3.

Tabla 45

1. Fibula; bron; d. 5,6 cm. Stavba 3, kv. 1078/C4, SE 177. Inv. št. 23835.
2. Fibula; bron; d. 6,8 cm. Stavba 3, kv. 1078/C4, SE 162. Inv. št. 23836.  
– Cunja, Mlinar 2010, 131, kat. 221; Modrijan 2011, sl. 2: 7.
3. Sponka za ogrlico; bron; d. 5,2 cm. Stavba 3, kv. 1128/D4, SE 106. Inv. št. 23530.
4. Jagoda, valjasta; steklo; d. 1,4 cm. Stavba 3, kv. 1077/B1, SE 169. Inv. št. 23575, *sl. 2.10: 1.*
5. Prstan; bron; pr. 2,2 cm. Stavba 3, kv. 1128/C3, SE 150. Inv. št. 23861.
6. Del prstana; srebro; d. 1,3 cm. Stavba 3, kv. 1077/C1, SE 137. Inv. št. 23858.
7. Uhan; bron; d. 1,6 cm. Stavba 3, kv. 1128/C2, SE 144. Inv. št. 23854.
8. Zakovica; bron; d.1,2 cm. Stavba 3, kv. 1127/A1, SE 144. Inv. št. 23863.
9. Iгла; železo; d. 7,2 cm. Stavba 3, kv. 928/B4, SE 170. Inv. št. 23866.
10. Iгла; železo; d. 6 cm. Stavba 3, kv. 1078/B3, SE 137. Inv. št. 23856.
11. Pločevina; bron; d. 2,7 cm. Stavba 3, kv. 1078/C4, SE 144. Inv. št. 23584.
12. Pločevina; bron; d. 2,6 cm. Stavba 3, SE 144. Inv. št. 23855.
13. Bronast predmet; bron; d. 4,7 cm. Stavba 3, kv. 1128/D2, SE 144. Inv. št. 23852.
14. Pasna spona; železo; v. 3,7 cm. Stavba 3, kv. 1077/B1, SE 06. Inv. št. 23838.
15. Pasni okov; bron; d. 3,3 cm. Stavba 3, kv. 1078/D3, SE 137. Inv. št. 23837.
16. Pločevina; bron; d. 1,9 cm. Stavba 3, kv. 1077/A1, SE 137. Inv. št. 23864.



17. Trak; bron; d. 4,8 cm. Stavba 3, kv. 1077/B1, SE 137. Inv. št. 23860.
18. Pušična ost; železo; d. 8,4 cm. Stavba 3, kv. 1078/C2, SE 135. Inv. št. 23868.
19. Šivanka; železo; d. 6,4 cm. Stavba 3, kv. 1288/A3, SE 137. Inv. št. 23857.
20. Šivanka; železo; d. 2 cm. Stavba 3, kv. 1078/C4, SE 135. Inv. št. 23859.
21. Šivanka; železo; d. 10,2 cm. Stavba 3, kv. 1077/C4, SE 138. Inv. št. 23867.
22. Glavnik; rogovina, železo. Stavba 3, kv. 1078/C2, SE 161. Inv. št. 23585.
23. Železen predmet; železo; d. 6 cm. kv. 1288/B4, Stavba 3, SE 144. Inv. št. 23865.
24. Orodje; železo; d. 9,5 cm. Stavba 3, kv. 1078/A4, SE 137. Inv. št. 23850.
25. Železen predmet; železo; d. 8,8 cm. Stavba 3, kv. 1077/B1, SE 137. Inv. št. 23851.
26. Brus; kamen; pr. 9,4 cm. Stavba 3, kv. 1077/B2, SE 144. Inv. št. 23574.

Tabla 46

1. Nož; železo; d. 11,5 cm. Stavba 3, kv. 1288/C4, SE 135. Inv. št. 23872.
2. Nož; železo; d. 13,4 cm. Stavba 3, kv. 1127/A1, SE 135. Inv. št. 23871.
3. Rezilo; železo; d. 4,6 cm. Stavba 3, kv. 1077/C1, SE 162. Inv. št. 23844.
4. Železen predmet; železo; d. 6 cm. Stavba 3, kv. 927/D2, SE 137. Inv. št. 23849.
5. Nož; železo; d. 7,5 cm. Stavba 3, kv. 1127/A1, SE 138. Inv. št. 23869.
6. Nož; železo; d. 5,4 cm. Stavba 3, kv. 1078/C4, SE 138. Inv. št. 23870.
7. Rezilo; železo; d. 5,8 cm. Stavba 3, kv. 1078/C2, SE 161. Inv. št. 23846.
8. Železen predmet; železo; d. 29 cm. Stavba 3, kv. 1078/B3, SE 150. Inv. št. 23840.
9. Ročaj ščita; železo; d. pribl. 36 cm. Stavba 3, kv. 1078/D3, SE 150. Inv. št. 23834.
10. Skoba; železo; d. 5,1 cm. Stavba 3, kv. 1128/A2, SE 135. Inv. št. 23862.
11. Železen predmet; železo; d. 4,8 cm. Stavba 3, kv. 1078/D4, SE 150. Inv. št. 23842.
12. Žebelj; železo; d. 3,3 cm. Stavba 3, kv. 1077/D4, SE 137. Inv. št. 23848.
13. Žebelj; železo; d. 3 cm. Stavba 3, kv. 1077/B1, SE 177. Inv. št. 23841.
14. Železen predmet; železo; d. 12,4 cm. Stavba 3, kv. 1078/A3, SE 160. Inv. št. 23843.
15. Žebelj; železo; d. 4,7 cm. Stavba 3, kv. 1288/B2, SE 135. Inv. št. 23845.
16. Železen predmet; železo; d. 9,5 cm. Stavba 3, kv. 1078/C2, SE 161. Inv. št. 23847.
17. Del ščita; železo; d. 7 cm. Stavba 3, kv. 1077/D1, SE 144. Inv. št. 23839.

Tabla 47

1. Prstan; bron; pr. 1,5 cm. Severna cerkev, kv. 1225/C1, SE 02. Inv. št. 23886.
2. Rezilo; železo; d. 2,5 cm. Severna cerkev, kv. 1225/D1, SE 02. Inv. št. 23485.
3. Žica; bron; d. 7,5 cm. Severna cerkev, kv. 1124/C1, SE 56. Inv. št. 23883.
4. Pušična ost; železo; d. 7,7, cm. Severna cerkev, kv. 1175/B4, SE 02. Inv. št. 23479.
5. Obroček; železo; pr. 3,8 cm. Severna cerkev, kv. 1126/B3, SE 02. Inv. št. 23463.
6. Nož; železo; d. 12 cm. Severna cerkev, SE 60. Inv. št. 23487.
7. Žebelj; železo; d. 7,7 cm. Severna cerkev, kv. 1225/B2, SE 02. Inv. št. 23457.
8. Konica; železo; d. 11 cm. Severna cerkev, SE 60. Inv. št. 23488.
9. Žebelj; železo; d. 15,5 cm. Severna cerkev, kv. 1224/A1, SE 02. Inv. št. 23414.
10. Ploščica; keramika; pr. 3,8 cm. Osrednja cerkev, kv. 1326/A1,B1, SE 02, 11. Inv. št. 23435.
11. Ploščica; svinec; pr. 2,8 cm. Osrednja cerkev, kv. 1326/A1,B1, SE 02, 11. Inv. št. 23435.
12. Trak; svinec; d. 6 cm. Osrednja cerkev, kv. 1326/A1,B1, SE 02, 11. Inv. št. 23436.
13. Žica; železo; d. 7 cm. Osrednja cerkev, kv. 1224/A3, SE 01. Inv. št. 23482.
14. Žebelj; železo; d. 2,3 cm. Osrednja cerkev, kv. 1283/B2, SE 02. Inv. št. 23453.
15. Šilo; železo; d. 3,9 cm. Osrednja cerkev, kv. 1224/B4, SE 02. Inv. št. 23484.
16. Žica (7 odlomkov); železo; d. do 6,3 cm. Osrednja cerkev, kv. 1173, SE 01. Inv. št. 23480.
17. Plošča; železo; pr. 8 cm. Osrednja cerkev, kv. 1325/B3, SE 02. Inv. št. 23486.

Tabla 48

1. Žebelj; železo; d. 12 cm. Osrednja cerkev, kv. 1224/A3, SE 02. Inv. št. 23477.
2. Nož; železo; d. 17,6 cm. Osrednja cerkev, kv. 1173/A3, SE 01. Inv. št. 23478.
3. Žebelj; železo; d. 14 cm. Osrednja cerkev, kv. 1223/B2, SE 01. Inv. št. 23476.
4. Žebelj; železo; d. 13 cm. Osrednja cerkev, kv. 1325, SE 02. Inv. št. 23474.
5. Žebelj; železo; d. 14 cm. Osrednja cerkev, kv. 1224/A3, SE 01. Inv. št. 23475.
6. Žebelj; železo; d. 15 cm. Osrednja cerkev, kv. 1275/D4, SE 01. Inv. št. 23419.
7. Žebelj; železo; d. 14 cm. Osrednja cerkev, kv. 1275, SE 01. Inv. št. 23421.
8. Žebelj; železo; d. 14 cm. Osrednja cerkev, kv. 1275, SE 01. Inv. št. 23473.
9. Žebelj; železo; d. 14,5 cm. Osrednja cerkev, kv. 1275, SE 01. Inv. št. 23420.
10. Žebelj; železo; d. 13 cm. Osrednja cerkev, kv. 1275, SE 01. Inv. št. 23422.
11. Žebelj; železo; d. 6,8 cm. Osrednja cerkev, kv. 1224/C3, SE 02. Inv. št. 23451.

12. Žebelj; železo; d. 4,6 cm. Osrednja cerkev, kv. 1224/D2, SE 02. Inv. št. 23483.

Tabla 49

1. Žebelj; železo; d. 15 cm. Osrednja cerkev, kv. 1274/C2, SE 02. Inv. št. 23415.
2. Žebelj; železo; d. 14 cm. Osrednja cerkev, kv. 1325/B3, SE 02. Inv. št. 23417.
3. Žebelj; železo; d. 14 cm. Osrednja cerkev, kv. 1224, SE 02. Inv. št. 23416.
4. Žebelj; železo; d. 15,5 cm. Osrednja cerkev, kv. 1325/B3, SE 02. Inv. št. 23418.
5. Železen predmet; železo; d. 11 cm. Osrednja cerkev. Inv. št. 23651.
6. Ključ; železo; d. 4,7 cm. Zunaj cerkva, kv. 1373/B1, C1, SE 21, zasutje groba 2. Inv. št. 23464.
7. Pločevina; bron; d. 2,2 cm. Zunaj cerkva, kv. 1120/D2, SE 01. Inv. št. 23450.
8. Žebelj; železo; d. 1,3 cm. Zunaj cerkva, kv. 1174, SE 01. Inv. št. 23458.
9. Puščična ost; železo; d. 7,9 cm. Južna cerkev, kv. 1372/D4, SE 01. Inv. št. 23452.
10. Puščična ost; železo; d. 8,3 cm. Južna cerkev, kv. 1422/D2, SE 02. Inv. št. 23449.
11. Žebelj; železo; d. 2,3 cm. Južna cerkev, kv. 1423, SE 01. Inv. št. 23459.
12. Konica; železo; d. 5,4 cm. Južna cerkev, kv. 1373, SE 02. Inv. št. 23466.
13. Žebelj; železo; d. 3,7 cm. Južna cerkev, kv. 1373/C3, SE 02. Inv. št. 23462.
14. Žebelj; železo; d. 6,3 cm. Južna cerkev, kv. 1373/B3, SE 02. Inv. št. 23461.
15. Žebelj; železo; d. 11 cm. Južna cerkev, kv. 1373/C2, SE 02. Inv. št. 23471.
16. Pločevina; bron; d. 2,3 cm. Južna cerkev, kv. 1472, SE 02. Inv. št. 23885.
17. Obroček; bron; pr. 1,7 cm. Južna cerkev, kv. 1321/B2, SE 02. Inv. št. 23888.

Tabla 50

1. Kotel; bron. Južna cerkev. Inv. št. 23567.

Tabla 51

1. Žebelj; železo; d. 13,5 cm. Memorija, kv. 1324/D1, SE 02. Inv. št. 23470.
2. Obroček; bron; pr. 2,5 cm. Memorija, kv. 1325/A4, SE 02. Inv. št. 23887.
3. Žebelj; železo; d. 3 cm. Memorija, kv. 1375, SE 01. Inv. št. 23455.
4. Uhan; bron; pr. 2 cm. Grob 3, kv. 1271/A4. Inv. št. 23570. – Ciglencečki 1997a, 22; Modrijan 2011, sl. 3: 1.
5. Uhan; bron; pr. 2,2 cm. Grob 3, kv. 1271/A4. Inv. št. 23571. – Ciglencečki 1997a, 22; Modrijan 2011, sl. 3: 2.
6. Prstan; srebro, steklo ali kamen; pr. 2,3 cm. Grob 3, kv. 1271/A4. Inv. št. 23569. – Ciglencečki 1997a, 22; Modrijan 2011, sl. 3: 3.

7. Ogrlica iz 17 jagod; steklo. Grob 3, kv. 1271/A4. Inv. št. 23568, sl. 2.13.

- a – cevasta s poliedričnim presekom, temno zelena, d. 1,1 cm
  - b – cevasta s poliedričnim presekom, temno zelena, d. 0,9 cm
  - c – cevasta, svetlo zelena, d. 0,6 cm
  - d – cevasta, modra, d. 0,6 cm
  - e – cevasta z izrastki, poliedrični presek, zelena, d. 0,6 cm
  - f – obročasta, temno modra, pr. 0,5 cm
  - g – obročasta, temno modra, pr. 0,4 cm
  - h – obročasta, temno modra, pr. 0,5 cm
  - i – obročasta, turkizna, pr. 0,4 cm
  - j – obročasta, temno modra, pr. 0,4 cm
  - k – obročasta, temno modra, pr. 0,4 cm
  - l – obročasta, modra, pr. 0,4 cm
  - m – obročasta, svetlo modra, pr. 0,4 cm
  - n – obročasta, svetlo modra, dva dela, pr. 0,4 cm
  - o – neprepoznavne oblike, zelena, dva dela
  - p – cevasta, polomljena, prozorna, d. 0,4 cm
  - r – poliedrična, modra z belo-rdeče-belo črto, d. 0,4 cm
- Ciglencečki 1997a, 22; Modrijan 2011, sl. 3: 4.

Tabla 52

1. Fibula; železo; pr. 4,5 cm. Vmesni prostor, kv. 1222/B2, SE 01. Inv. št. 23469.
2. Jagoda, štiridelna; steklo; d. 3,8 cm. Vmesni prostor, kv. 1324/B3, SE 80. Inv. št. 23654, sl. 2.12: 2.
3. Jagoda, cevasta; steklo; d. 0,6 cm. Vmesni prostor, kv. 1324/A3SE 71. Inv. št. 23653, sl. 2.12: 1.
4. Prstan; bron, steklo ali kamen; pr. 2,4 cm. Vmesni prostor, kv. 1272, SE 96. Inv. št. 23633.
5. Trak; bron; d. 1,7 cm. Vmesni prostor, kv. 1272, SE 92. Inv. št. 23635.
6. Trak; bron; d. 4,8 cm. Vmesni prostor, kv. 1272, SE 92. Inv. št. 23638.
7. Fibula; bron; d. 2,2 cm. Vmesni prostor, kv. 1272, SE 92. Inv. št. 23639.
8. Trak; bron; d. 2,1 cm. Vmesni prostor, kv. 1272, SE 95. Inv. št. 23640.
9. Prstan; bron; d. 1,8 cm. Vmesni prostor, kv. 1222/C2, SE 107. Inv. št. 23877.
10. Nož; železo; d. 4,3 cm. Vmesni prostor, kv. 1272, SE 96. Inv. št. 23637.
11. Žebelj; železo; d. 0,7 cm. Vmesni prostor, kv. 1272, SE 96. Inv. št. 23636.
12. Trak; bron; d. 1,3 cm. Vmesni prostor, kv. 1272, SE 97. Inv. št. 23641.
13. Trak; svinec; d. 2,5 cm. Vmesni prostor, kv. 1272, SE 94. Inv. št. 23644.
14. Železen predmet; železo; d. 2,6 cm. Vmesni prostor, kv. 1272, SE 97. Inv. št. 23642.
15. Železen predmet; železo; d. 5,6 cm. Vmesni prostor, kv. 1252, SE 99. Inv. št. 23645.
16. Žebelj; železo; d. 13 cm. Vmesni prostor, kv. 1273/D2, SE 02. Inv. št. 23655.
17. Nož; železo; d. 11,5 cm. Vmesni prostor, kv. 1272, SE 96. Inv. št. 23643.
18. Žebelj; železo; d. 1,6 cm. Vmesni prostor, SE 02a. Inv. št. 23658.
19. Konica; železo; d. 4,7 cm. Vmesni prostor, kv. 1273/B4, SE 02. Inv. št. 23657.

20. Kamen; kamen; pr. 4,4 cm. Vmesni prostor, kv. 1272, SE 71. Inv. št. 23632.

Tabla 53

1. Svinčen predmet; svinec; d. 7 cm. Vmesni prostor, SE 108. Inv. št. 23874.
2. Svinčen predmet; svinec; d. 3,7 cm, m. 66,80 g. Vmesni prostor, kv. 1222/C4, SE 107. Inv. št. 23879.
3. Svinčen predmet; svinec; d.3,8 cm. Vmesni prostor, SE 107. Inv. št. 23876.
4. Svinčen predmet; svinec; d. 4,7 cm. Vmesni prostor, SE 108. Inv. št. 23875.
5. Nož; železo; d. 4,4 cm. Vmesni prostor. Inv. št. 23873.
6. Žebelj; železo; d. 1,8 cm. Vmesni prostor, SE 108. Inv. št. 23878.
7. Žebelj; železo; d. 3,4 cm. Vmesni prostor, kv. 1222/D3. Inv. št. 23881.
8. Žebelj; železo; d. 6 cm. Vmesni prostor, kv. 1222/D3. Inv. št. 23880.
9. Žebelj; železo; d. 4,5 cm. Vmesni prostor, kv. 1222/D3, SE 107. Inv. št. 23882.
10. Fibula; bron; d. 6,8 cm. Grob 21, kv. 1272, SE 94. Inv. št. 23820.  
– Cunja, Mlinar 2010, 127, kat. 198; Modrijan 2011, sl. 6: 3.
11. Prstan; bron; pr. 2,2 cm. Grob 21, kv. 1272, SE 94. Inv. št. 23821.  
– Modrijan 2011, sl. 6: 2.
12. Nož; železo; d. 9,7 cm. Grob 21, kv. 1272, SE 94. Inv. št. 23822.  
– Modrijan 2011, sl. 6: 1.
- Uhan; bron, prozorno steklo (jagoda). Grob 21, kv. 1272, SE 94. Uničen.
- Uhan; bron, prozorno steklo (jagoda). Grob 21, kv. 1272, SE 94. Uničen.
13. Srp; železo; d. 18 cm. Cisterna, kv. 984/C1, SE 201. Inv. št. 23572.
14. Brus; kamen; d. 7,8 cm. Cisterna, kv. 885/D4, SE 201. Inv. št. 23681.
15. Pušičična ost; železo; d. 7,5 cm. Cisterna, kv. 834/B2, SE 201. Inv. št. 23573.

Tabla 54

1. Ustje; steklo; modro. Stavba 1, kv. 717/D4. Inv. št. 23007, sl. 3.1: 1.
2. Ostenje; steklo; vijoličasto-belo marmorirano. Stavba 1, kv. 816/A2, SE 09. Inv. št. 23058, sl. 3.1: 2.
3. Ročaj; steklo; svetlo modro. Stavba 1, kv. 968/D2, SE 06. Inv. št. 23018.
4. Ustje; steklo; zelenkasto. Stavba 1, kv. 868, SE 34. Inv. št. 22994.
5. Ostenje; steklo; rumenkasto, modro. Stavba 1, kv. 719/D4. Inv. št. 24140.
6. Ustje; steklo; zeleno. Stavba 1, kv. 669/A3,A4,B3,B4, SE 24. Inv. št. 22992.  
– Ciglencečki, Milavec 2009, t. 1: 8.
7. Ustje; steklo; zelenkasto. Stavba 1, kv. 716/A4, SE 23. Inv. št. 22998.

8. Ustje; steklo; svetlo zelenkasto. Stavba 1, kv. 666/D4, SE 24. Inv. št. 22999.

9. Ustje; steklo; rumenozeleno. Stavba 1, kv. 669/B2, SE 24. Inv. št. 22997.
10. Ustje; steklo; rumenozeleno. Stavba 1, kv. 666/A4, SE 29. Inv. št. 22996.
11. Ustje; steklo; rumenkasto. Stavba 1, kv. 666/B 1, SE 34. Inv. št. 22993.
12. Ustje; steklo; zelenkasto. Stavba 1, kv. 619/B 3. Inv. št. 22995.
13. Ustje; steklo; svetlo rumenkasto. Stavba 1, kv. 632/A1, SE 10. Inv. št. 23000.
14. Ustje; steklo; zelenkasto. Stavba 1, kv. 754/D2, SE 56. Inv. št. 23006.
15. Ustje; steklo; rumenozeleno. Stavba 1, kv. 666/B3, SE 50. Inv. št. 23002.  
– Milavec 2009, t. 1: 2.
16. Ustje; steklo; zelenkasto. Stavba 1, kv. 769/A1, SE 03. Inv. št. 23012.  
– Milavec 2009, t. 1: 3.
17. Ustje; steklo; rumenozeleno. Stavba 1, kv. 716/A1, SE 06. Inv. št. 23021.
18. Ustje; steklo; belo. Stavba 1, kv. 668/B2, SE 26. Inv. št. 23003.
19. Ustje; steklo; zeleno. Stavba 1, kv. 666/A1, SE 50. Inv. št. 23008.
20. Ustje; steklo; zelenkasto. Stavba 1, kv. 673/A3, SE 23. Inv. št. 23004.
21. Ustje; steklo; rumenkasto. Stavba 1, kv. 716/A2, SE 23. Inv. št. 23005.
22. Ustje; steklo; zeleno. Stavba 1, kv. 716/C2. Inv. št. 23019.
22. Ustje; steklo; zeleno. Stavba 1, kv. 716/C2. Inv. št. 23019.
23. Ustje; steklo; zelenkasto. Stavba 1, kv. 716/B2, SE 06. Inv. št. 23009.
23. Ustje; steklo; zelenkasto. Stavba 1, kv. 716/B2, SE 06. Inv. št. 23009.
24. Ustje; steklo; svetlo rumenkasto. Stavba 1, kv. 669/A3,A4,B3,B4, SE 23. Inv. št. 23001.
25. Ustje; steklo; svetlo rumeno. Stavba 1, kv. 719/B3. Inv. št. 23020.
26. Ustje; steklo; rumenkasto-zelenkasto. Stavba 1, kv. 713/B2, SE 23. Inv. št. 23023.

Tabla 55

1. Ustje; steklo; rumenkasto. Stavba 1, kv. 716/A2, SE 03. Inv. št. 23028.
2. Ustje; steklo; zeleno. Stavba 1, kv. 755/B4, SE 03. Inv. št. 23024.
3. Ustje; steklo; rumenozeleno. Stavba 1, kv. 666/B4, SE 06. Inv. št. 23031.  
– Milavec 2009, t. 1: 9.
4. Ustje; steklo; zelenkasto. Stavba 1, kv. 755/A2,B2,B3, SE 08. Inv. št. 23027.
5. Ustje; steklo; rumenkasto-zelenkasto. Stavba 1, kv. 755/A3, SE 03. Inv. št. 23022.
6. Ustje; steklo; zelenkasto. Stavba 1, kv. 918/B1, SE 62. Inv. št. 23034.  
– Milavec 2009, t. 1: 8.
7. Ustje; steklo; rumenkasto. Stavba 1. Slučajna najdba. Inv. št. 23048.

8. Ustje; steklo; rumenkasto. Stavba 1, kv. 666/A2,A3,B2,B3, SE 03. Inv. št. 23087.
9. Ustje; steklo; rumenkasto. Stavba 1, kv. 666/A2,A3,B2,B3, SE 34. Inv. št. 23088.
10. Ustje; steklo; prosojno. Stavba 1, SE 01. Inv. št. 23049.
11. Ustje; steklo; rumenkasto. Stavba 1, kv. 618/A1, SE 34. Inv. št. 23052.
12. Ustje; steklo; prosojno. Stavba 1, kv. 619/B1, SE 64. Inv. št. 23050.
13. Ustje; steklo; svetlo rumenkasto. Stavba 1. Inv. št. 23051.
14. Ustje; steklo; rumenkasto-zelenkasto. Stavba 1, kv. 675/D3, SE 05. Inv. št. 23040.  
– Milavec 2009, t. 1: 6.
15. Ustje; steklo; zeleno. Stavba 1, kv. 569/C4, SE 34. Inv. št. 23042.
16. Ustje; steklo; zelenkasto. Stavba 1, kv. 675/B4, SE 05. Inv. št. 23026.
17. Ustje; steklo; svetlo rumenkasto. Stavba 1, kv. 666/A2, SE 29. Inv. št. 23043.
18. Ustje; steklo; prosojno. Stavba 1, kv. 666/C1, SE 50. Inv. št. 23053.
19. Ustje; steklo; zeleno. Stavba 1, kv. 666/C2, SE 50. Inv. št. 23045.
20. Ustje; steklo; svetlozeleno. Stavba 1, kv. 619/A3, SE 34. Inv. št. 23044.
21. Ustje; steklo; rumeno-zelenkasto. Stavba 1, kv. 666/B2, SE 29. Inv. št. 23047.
22. Ustje; steklo; zeleno. Stavba 1, kv. 675/B1, SE 26. Inv. št. 23060.  
– Milavec 2009, t. 1: 23.
23. Ustje; steklo; rumenozeleno. Stavba 1, kv. 716/B4, SE 23. Inv. št. 23406.
24. Ustje; steklo; zelenkasto. Stavba 1, kv. 766/C1, SE 24. Inv. št. 23410.
25. Ustje; steklo; zelenkasto. Stavba 1, kv. 713/B1, SE 23. Inv. št. 23025.  
– Milavec 2009, t. 1: 4.
26. Ustje; steklo; rumenozeleno. Stavba 1, kv. 667/B3,B4, SE 08. Inv. št. 23411.
27. Ustje; steklo; zelenkasto. Stavba 1, kv. 674/D2, SE 08. Inv. št. 23085.  
– Milavec 2009, t. 1: 5.
7. Ustje; steklo; svetlo zelenkasto. Stavba 1, kv. 634/A3, SE 24. Inv. št. 23041.
8. Ustje; steklo; zeleno. Stavba 1, kv. 666/A4. Inv. št. 23046.
9. Ustje; steklo; zelenkasto. Stavba 1, kv. 666/C3, SE 24. Inv. št. 23065.  
– Milavec 2009, t. 1: 27.
10. Ustje; steklo; rumenkasto-zelenkasto. Stavba 1, kv. 716/A1, SE 03. Inv. št. 23079.  
– Milavec 2009, t. 1: 32.
11. Noga; steklo; rumenkasto. Stavba 1, kv. 766/B2, SE 24. Inv. št. 23398.
12. Noga; steklo; rumenkasto. Stavba 1, kv. 669/D2, SE 23. Inv. št. 23405.
13. Noga; steklo; zelenkasto. Stavba 1, kv. 666/C2, SE 23. Inv. št. 23404.
14. Noga; steklo; zelenkasto. Stavba 1, kv. 818/A2, SE 03. Inv. št. 23403.
15. Noga; steklo; zeleno. Stavba 1, kv. 676/A2, SE 01. Inv. št. 23059.  
– Milavec 2009, t. 1: 22.
16. Noga; steklo; zeleno. Stavba 1, kv. 675/B1, SE 26. Inv. št. 23060.  
– Milavec 2009, t. 1: 23.
17. Noga; steklo; zelenkasto. Stavba 1, kv. 870/C4, SE 70. Inv. št. 23061.  
– Milavec 2009, t. 1: 24.
18. Noga; steklo; zelenkasto. Stavba 1, kv. 716. Inv. št. 23062.  
– Milavec 2009, t. 1: 25.
19. Noga; steklo; rumenozeleno. Stavba 1, kv. 795/B1,B2, SE 34. Inv. št. 23064.  
– Milavec 2009, t. 1: 26.
20. Noga; steklo; zelenkasto. Stavba 1, kv. 666/C3, SE 24. Inv. št. 23065.  
– Milavec 2009, t. 1: 27.
21. Noga; steklo; zelenkasto-rumenkasto. Stavba 1, kv. 717/C3,C4, SE 10. Inv. št. 23066.  
– Milavec 2009, t. 1: 28.
22. Noga; steklo; zelenkasto. Stavba 1, kv. 666/A2, SE 29. Inv. št. 23067.  
– Milavec 2009, t. 1: 29.
23. Noga; steklo; rumeno. Stavba 1, kv. 870/D3, SE 69, 70. Inv. št. 23070.  
– Milavec 2009, t. 1: 30.
24. Noga; steklo; rumenozeleno. Stavba 1, kv. 672/A2. Inv. št. 23080.  
– Milavec 2009, t. 1: 31.
25. Noga; steklo; rumenkasto-zelenkasto. Stavba 1, kv. 716/A1, SE 03. Inv. št. 23079.  
– Milavec 2009, t. 1: 32.
26. Noga; steklo; rumenkasto. Stavba 1, kv. 666/C3, SE 23. Inv. št. 23076.  
– Milavec 2009, t. 1: 33.
27. Noga; steklo; rumeno. Stavba 1, kv. 756/A2, SE 03. Inv. št. 23081.  
– Milavec 2009, t. 1: 34.
28. Noga; steklo; modro. Stavba 1, kv. 669/B4, SE 23. Inv. št. 23071.  
– Milavec 2009, t. 1: 35.
29. Kozarec; steklo; zelenkasto. Stavba 1, kv. 720/A3, SE 01. Inv. št. 22468.  
– Milavec 2009, t. 1: 36.

*Tabla 56*

1. Ustje; steklo; zelenkasto. Stavba 1, kv. 619/C3, SE 64. Inv. št. 23032.  
– Milavec 2009, t. 1: 7.
2. Ustje; steklo; rumenozeleno. Stavba 1, kv. 719/C4. Inv. št. 23409.
3. Ustje; steklo; zelenkasto. Stavba 1, kv. 716/C2, SE 24. Inv. št. 23412.
4. Ustje; steklo; rumenkasto. Stavba 1, kv. 816/B1, SE 01. Inv. št. 23407.
5. Ustje; steklo; zelenkasto. Stavba 1, kv. 668/C2, SE 01. Inv. št. 23413.
6. Ustje; steklo; zeleno. Stavba 1, kv. 719/C4, SE 05. Inv. št. 23408.
6. Ustje; steklo; zelenkasto. Stavba 1, kv. 719/C4, SE 05. Inv. št. 23408.

30. Kozarec; steklo; zelenkasto. Stavba 1, kv. 717/D4, SE 10. Inv. št. 22469.  
 31. Noga; steklo; zelenkasto. Stavba 1. Slučajna najdba. Inv. št. 22469.  
 32. Noga; steklo; zelenkasto. Stavba 1, kv. 716/A2, SE 23. Inv. št. 23401.  
 33. Noga; steklo; zelenkasto. Stavba 1. Inv. št. 23402.  
 34. Noga; steklo; rumeno. Stavba 1. Inv. št. 23082.  
 35. Noga; steklo; rumenkasto. Stavba 1, kv. 766/C2, SE 23. Inv. št. 23747.  
 36. Kozarec; steklo; zelenkasto. Stavba 1, kv. 717/B3, SE 08. Inv. št. 22467.

Tabla 57

1. Dno; steklo; rjavozeleno. Stavba 1, kv. 619/C2, SE 68. Inv. št. 23063.  
 – Milavec 2009, t. 1: 11.  
 2. Dno; steklo; zeleno. Stavba 1, kv. 634/A4, SE 29a. Inv. št. 23068.  
 – Milavec 2009, t. 1: 12.  
 3. Dno; steklo; svetlo zeleno. Stavba 1, kv. 666/A3, SE 29. Inv. št. 23056.  
 – Milavec 2009, t. 1: 13.  
 4. Dno; steklo; zeleno. Stavba 1, kv. 634/B3, SE 29a. Inv. št. 23074.  
 – Milavec 2009, t. 1: 14.  
 5. Dno; steklo; zelenkasto. Stavba 1, kv. 669/C3, SE 29. Inv. št. 23077.  
 – Milavec 2009, t. 1: 15.  
 6. Dno; steklo; rumenozeleno. Stavba 1, kv. 669/B1, SE 29. Inv. št. 23397.  
 – Milavec 2009, t. 1: 16.  
 7. Dno; steklo; rumenozeleno. Stavba 1, kv. 716/A1, SE 23. Inv. št. 23399.  
 – Milavec 2009, t. 1: 17.  
 8. Dno; steklo; zeleno. Stavba 1, kv. 754/B1, SE 10. Inv. št. 23075.  
 – Milavec 2009, t. 1: 19.  
 9. Dno; steklo; olivno zeleno. Stavba 1, kv. 569/D3. Inv. št. 23054.  
 – Milavec 2009, t. 1: 18.  
 10. Dno; steklo; rumenkasto. Stavba 1, kv. 719/D1. Inv. št. 23719.  
 – Milavec 2009, t. 1: 20.  
 11. Dno; steklo; rumenozeleno. Stavba 1, kv. 666/B1, SE 24. Inv. št. 23816.  
 – Milavec 2009, t. 1: 21.  
 12. Dno; steklo; zeleno. Stavba 1, kv. 754/D2, SE 12. Inv. št. 23073.  
 – Milavec 2009, t. 1: 10.  
 13. Ustje; steklo; zeleno. Stavba 1, kv. 817/C3,D3, SE 03. Inv. št. 23033.  
 – Milavec 2009, t. 2: 3.  
 14. Vrat; steklo; zelenkasto. Stavba 1, kv. 719/B2, SE 01. Inv. št. 23055.  
 – Milavec 2009, t. 2: 4.  
 15. Ostenje; steklo; zeleno. Stavba 1, kv. 669/B3, SE 29a. Inv. št. 23089.  
 – Milavec 2009, t. 2: 5.

16. Ostenje; steklo; zeleno. Stavba 1, kv. 669/B3, SE 29A. Inv. št. 23057.  
 17. Ostenje; steklo; zeleno. Stavba 1, kv. 720/A4, SE 01. Inv. št. 23011.  
 18. Ostenje; steklo; rumenkasto-zelenkasto. Stavba 1, kv. 667/D3,D4, SE 06. Inv. št. 23013.  
 19. Ročaj svetilke; steklo; rumeno. Stavba 1, kv. 672/C1, SE 06. Inv. št. 23015.  
 – Milavec 2009, t. 2: 9.  
 20. Ročaj svetilke; steklo; zeleno. Stavba 1, kv. 672/D3, SE 06. Inv. št. 23016.  
 – Milavec 2009, t. 2: 10.  
 21. Ročaj in ustje svetilke; steklo; rumenkasto. Stavba 1, kv. 675/D3, SE 26. Inv. št. 23014.  
 – Milavec 2009, t. 2: 7.  
 22. Ročaj; steklo; zeleno. Stavba 1, kv. 816/D2,D1. Inv. št. 23017.

Tabla 58

1. Dno balzamarija; steklo; rumenkasto-zelenkasto. Stavba 1, kv. 817/D2, SE 03. Inv. št. 23069.  
 – Milavec 2009, t. 2: 8.  
 2. Noga; steklo; zeleno. Stavba 1, kv. 769/A1, SE 03. Inv. št. 23078.  
 – Milavec 2009, t. 2: 12.  
 3. Noga; steklo; zelenkasto. Stavba 1, kv. 867/D2. Inv. št. 23072.  
 4. Noga; steklo; zelenkasto. Stavba 1, kv. 669/B2, SE 24. Inv. št. 23083.  
 – Milavec 2009, t. 2: 2.  
 5. Noga; steklo; rumenozeleno. Stavba 1, kv. 817/B4, SE 05. Inv. št. 23400.  
 – Milavec 2009, t. 2: 1.  
 6. Noga; steklo; zelenkasto. Stavba 1, kv. 619/C3, SE 74. Inv. št. 23010.  
 7. Ustje; steklo; brezbarvno. Stavba 1, kv. 669, SE 29. Inv. št. 23030.  
 – Milavec 2009, t. 2: 11.  
 8. Ustje; steklo; zelenkasto. Stavba 1, kv. 669/C4, SE 07. Inv. št. 23029.  
 9. Ustje; steklo; zelenkasto. Stavba 2, kv. 1279/A1. Inv. št. 23829.  
 10. Ustje; steklo; rjavkasto. Stavba 2, kv. 1229, SE 106. Inv. št. 23830.  
 11. Noga; steklo; zeleno. Stavba 2, kv. 1179/B2, SE 106. Inv. št. 23828.  
 12. Noga; steklo; zeleno. Stavba 2, kv. 1178/B2, SE 112. Inv. št. 23827.  
 13. Noga; steklo; rumenkasto. Stavba 2, kv. 1178/B3, SE 106. Inv. št. 23826.  
 14. Noga; steklo; rumenkasto. Stavba 2, kv. 1178/B2, SE 112. Inv. št. 23825.  
 15. Dno; steklo; zeleno. Stavba 2, kv. 1229/D4, SE 106. Inv. št. 23833.  
 16. Dno; steklo; rjavkasto. Stavba 2, kv. 1229/D4, SE 106. Inv. št. 23832.  
 17. Dno; steklo; rjavkasto. Stavba 2, kv. 1229/D4, SE 106. Inv. št. 23831.  
 18. Ročaj svetilke; steklo; rjavkasto. Stavba 2, kv. 1178/A1, SE 112. Inv. št. 23824.

19. Ustje; steklo; rumenkasto. Stavba 3, SE 137. Inv. št. 23579.  
 20. Ustje; steklo; rumenkasto. Stavba 3, kv. 928/D3, SE 158. Inv. št. 23578.  
 21. Ustje; steklo; rumenkasto. Stavba 3, SE 162. Inv. št. 23577.

Tabla 59

1. Ustje; steklo; zelenkasto. Stavba 3, kv. 1077/D1, SE 150. Inv. št. 23594.  
 2. Ustje; steklo; rumenkasto. Stavba 3, kv. 1078/D4, SE 160. Inv. št. 23586.  
 3. Ustje; steklo; zelenkasto. Stavba 3, SE 161. Inv. št. 23589.  
 4. Ustje; steklo; zelenkasto. Stavba 3, kv. 1077/D1, SE 144. Inv. št. 23590.  
 5. Ustje; steklo; zelenkasto. Stavba 3, kv. 1128/D2, SE 144. Inv. št. 23853.  
 6. Ustje; steklo; rumenkasto. Stavba 3, kv. 1128/B3, SE 135. Inv. št. 23576.  
 7. Noga; steklo; zelenkasto. Stavba 3, kv. 1078/D1, SE 144. Inv. št. 23592.  
 8. Noga; steklo; zeleno. Stavba 3, kv. 1078/B2, SE 137. Inv. št. 23593.  
 9. Dno; steklo; zeleno. Stavba 3, kv. 1078/B3, SE 160. Inv. št. 23591.  
 10. Ustje; steklo; rumeno. Severna cerkev, kv. 1226/D1, SE 02. Inv. št. 23504.  
 11. Ustje; steklo; rumenkasto. Severna cerkev, kv. 1124, SE 54. Inv. št. 23423.  
 12. Ustje; steklo; zeleno. Severna cerkev, kv. 1124, SE 56. Inv. št. 23424.  
 13. Ustje; steklo; rumenkasto. Severna cerkev, kv. 1277/A1, SE 01. Inv. št. 23442.  
 14. Noga; steklo; rumenkasto. Severna cerkev, kv. 1124/C1, SE 56. Inv. št. 23425.  
 15. Ustje; steklo; zelenkasto. Osrednja cerkev, kv. 1326/A1,B1, SE 02,11. Inv. št. 23429.  
 16. Ustje; steklo; zelenkasto. Osrednja cerkev, kv. 1326/A1,B1, SE 02,11. Inv. št. 23430.  
 17. Ustje; steklo; rumeno-zeleno. Osrednja cerkev, kv. 1324/D1, SE 02. Inv. št. 23509.  
 18. Ustje; steklo; zelenkasto. Osrednja cerkev, kv. 1326/A1,B1, SE 02,11. Inv. št. 23431.  
 19. Ustje; steklo; zelenkasto. Osrednja cerkev, kv. 1325, SE 02. Inv. št. 23438.  
 20. Ustje; steklo; rumeno. Osrednja cerkev, kv. 1326/B2, SE 02. Inv. št. 23499.  
 21. Ustje; steklo; rumeno. Osrednja cerkev, SE 02. Inv. št. 23501.  
 22. Ustje; steklo; zelenkasto. Osrednja cerkev, kv. 1325/A2, SE 11. Inv. št. 23503.

Tabla 60

1. Dno; steklo; rumeno-zeleno. Osrednja cerkev, kv. 1324/D1, SE 02. Inv. št. 23506.  
 2. Dno; steklo; rjavkasto. Osrednja cerkev, kv. 1326/A1,B1, SE 02,11. Inv. št. 23432.  
 3. Dno; steklo; rumeno. Osrednja cerkev, kv. 1324/D1, SE 02. Inv. št. 23505.

4. Dno; steklo; rumeno-zeleno. Osrednja cerkev, kv. 1324/D1, SE 02. Inv. št. 23507.  
 5. Dno; steklo; zelenkasto. Osrednja cerkev, kv. 1326/A1,B1, SE 02, 11. Inv. št. 23434.  
 6. Dno; steklo; zelenkasto. Osrednja cerkev, kv. 1326/A1,B1, SE 02,11. Inv. št. 23433.  
 7. Svetilka; steklo; zelenkasto. Osrednja cerkev, kv. 1325/A2, SE 11. Inv. št. 23448.  
 – Milavec 2009, t. 2: 6.  
 8. Svetilka; steklo; svetlo zeleno. Osrednja cerkev, kv. 1326/A1,B1, SE 02,11. Inv. št. 23426.  
 9. Svetilka; steklo; rumenkasto. Osrednja cerkev, kv. 1325/A2, SE 11. Inv. št. 23446.  
 10. Svetilka; steklo; temno zelenkasto. Osrednja cerkev, kv. 1326/A1,B1, SE 02,11. Inv. št. 23427.  
 11. Svetilka; steklo; zelenkasto. Osrednja cerkev, kv. 1326/D2, SE 02. Inv. št. 23447.  
 12. Svetilka; steklo; zelenkasto. Osrednja cerkev, kv. 1325/D1, SE 02. Inv. št. 23440.  
 13. Ročaj svetilke; steklo; svetlo zeleno. Osrednja cerkev, kv. 1326/A1,B1, SE 02,11. Inv. št. 23428.  
 14. Ustje; steklo; rumenkasto. Osrednja cerkev, kv. 1324/D1, SE 02. Inv. št. 23508.  
 15. Ustje; steklo; zelenkasto. Osrednja cerkev, SE 02. Inv. št. 23502.  
 16. Ustje; steklo; zelenkasto. Memorija, kv. 1375/A2, SE 04. Inv. št. 23492.  
 17. Ustje; steklo; zelenkasto. Memorija, kv. 1375/A2, SE 04. Inv. št. 23491.  
 18. Noga; steklo; zelenkasto. Memorija, kv. 1324/C4, SE 02. Inv. št. 23498.

Tabla 61

1. Dno; steklo; rumeno. Memorija, kv. 1374/B2. Inv. št. 23500.  
 2. Dno; steklo; svetlo modro. Memorija, kv. 1324/C4, SE 02. Inv. št. 23497.  
 3. Dno; steklo; zelenkasto. Memorija, kv. 1375/A2, SE 04. Inv. št. 23495.  
 4. Dno; steklo; rumenkasto. Memorija, kv. 1325/A4, SE 02. Inv. št. 23444.  
 5. Vrat steklenice; steklo; rumeno-zeleno. Memorija, kv. 1375/A2, SE 04. Inv. št. 23510.  
 6. Ustje; steklo; zelenkasto. Memorija, kv. 1375/A2, SE 04. Inv. št. 23493.  
 7. Ustje; steklo; zelenkasto. Memorija, kv. 1375/A2, SE 04. Inv. št. 23494.  
 8. Dno balzamarija; steklo; rumenkasto. Memorija, kv. 1325/A4, SE 02. Inv. št. 23445.  
 9. Dno balzamarija; steklo; rumeno. Memorija, kv. 1375/A2, SE 04. Inv. št. 23511.  
 10. Dno steklenice; steklo; zelenkasto. Južna cerkev, kv. 1322/D4, SE 02. Inv. št. 23496.  
 11. Ustje; steklo; zelenkasto. Zasutje groba 1, kv. 1423/D4, SE Zasutje groba 1. Inv. št. 23441.  
 12. Ročaj svetilke; steklo; rumenkasto. Zasutje groba 1, kv. 1422, SE 06. Inv. št. 23443.  
 13. Ustje; steklo; zelenkasto. Zasutje groba 7, kv. 1326, SE Zasutje groba 7. Inv. št. 23437.  
 14. Ustje; steklo; rumenkasto. Zasutje groba 21, kv. 1272, SE 94. Inv. št. 23601.

15. Ustje; steklo; zelenkasto. Zasutje groba 21, SE 94. Inv. št. 23602.

16. Dno; steklo; zeleno. Zasutje groba 21, SE 94. Inv. št. 23603.

17. Ustje; steklo; rumenkasto. Vmesni prostor, kv. 1273/C2, SE 02. Inv. št. 23661.

18. Ustje; steklo; rumenkasto. Vmesni prostor, kv. 1273/D3, SE 02. Inv. št. 23664.

19. Ustje; steklo; rumenkasto. Vmesni prostor, kv. 1324/A1, SE 84. Inv. št. 23666.

20. Ustje; steklo; zelenkasto. Vmesni prostor, kv. 1323/D1, SE 02. Inv. št. 23674.

21. Ustje; steklo; rumenkasto. Vmesni prostor, SE 02a. Inv. št. 23667.

22. Ustje; steklo; zelenkasto. Vmesni prostor, kv. 1323/D1, SE 02. Inv. št. 23673.

23. Ustje; steklo; rumenkasto. Vmesni prostor, kv. 1272, SE 74. Inv. št. 23649.

*Tabla 62*

1. Ustje; steklo; rumenkasto. Vmesni prostor, kv. 1272, SE 102. Inv. št. 23612.

2. Ustje; steklo; zelenkasto. Vmesni prostor, kv. 1272, SE 74. Inv. št. 23609.

3. Ustje; steklo; rumenkasto. Vmesni prostor. Inv. št. 23614.

4. Ustje; steklo; zelenkasto. Vmesni prostor, kv. 1272, SE 89. Inv. št. 23605.

5. Ustje; steklo; rjavkasto. Vmesni prostor, kv. 1272, SE 102. Inv. št. 23613.

6. Ustje; steklo; rumeno. Vmesni prostor, kv. 1272, SE 93. Inv. št. 23615.

7. Ustje; steklo; zelenkasto. Vmesni prostor. Inv. št. 23647.

8. Ustje; steklo; rumenkasto. Vmesni prostor, kv. 1272, SE 103. Inv. št. 23648.

9. Ustje; steklo; rumenkasto. Vmesni prostor, kv. 1272, SE 97. Inv. št. 23600.

10. Ustje; steklo; zelenkasto. Vmesni prostor, kv. 1222/C2, SE 100. Inv. št. 23623.

11. Ustje; steklo; rumenkasto. Vmesni prostor, SE 78. Inv. št. 23608.

12. Ustje; steklo; turkizno. Vmesni prostor, kv. 1272, SE 89. Inv. št. 23604.

13. Ustje; steklo; zelenkasto. Vmesni prostor, kv. 1252, SE 92. Inv. št. 23622.

14. Ustje; steklo; rumenkasto. Vmesni prostor, kv. 1272/C1, SE 01. Inv. št. 23439.

15. Ustje; steklo; rumenkasto. Vmesni prostor, kv. 64?, SE 84. Inv. št. 23663.

16. Ustje; steklo; rumenkasto. Vmesni prostor, kv. 1272, SE 96. Inv. št. 23619.

17. Ustje; steklo; zeleno. Vmesni prostor, kv. 1272, SE 76. Inv. št. 23610.

18. Ustje; steklo; rumenkasto. Vmesni prostor, SE 89. Inv. št. 23598.

19. Ustje; steklo; zelenkasto. Vmesni prostor, kv. 1272, SE 96. Inv. št. 23631.

20. Ustje; steklo; zelenkasto. Vmesni prostor, kv. 1272, SE 96. Inv. št. 23630.

21. Ustje; steklo; zelenkasto. Vmesni prostor, kv. 1272, SE 96. Inv. št. 23629.

22. Ustje; steklo; zelenkasto. Vmesni prostor, kv. 1222/C2, SE 100. Inv. št. 23626.

23. Ustje; steklo; zelenkasto. Vmesni prostor, kv. 1222/C2, SE 100. Inv. št. 23625.

24. Ustje; steklo; zelenkasto. Vmesni prostor, kv. 1222/C2, SE 100. Inv. št. 23624.

25. Ustje; steklo; rumenkasto. Vmesni prostor, kv. 1272, SE 96. Inv. št. 23611.

*Tabla 63*

1. Ustje in stena; steklo; rumenkasto. Vmesni prostor, kv. 64?, SE 84. Inv. št. 23663.

2. Noga; steklo; zelenkasto. Vmesni prostor, kv. 1272, SE 89. Inv. št. 23606.

3. Noga; steklo; rumeno. Vmesni prostor, kv. 1272, SE 96. Inv. št. 23618.

4. Noga; steklo; rumenkasto. Vmesni prostor, kv. 1273/D3, SE 62 (sonda 93). Inv. št. 23676.

5. Noga; steklo; rumenkasto. Vmesni prostor, SE 71. Inv. št. 23659.

6. Dno; steklo; rjavkasto. Vmesni prostor, SE 02a. Inv. št. 23668.

7. Dno; steklo; zeleno. Vmesni prostor, kv. 1273/D3, SE 62 (sonda 93). Inv. št. 23671.

8. Dno; steklo; zelenkasto. Vmesni prostor, kv. 1323/D1, SE 02. Inv. št. 23675.

9. Dno; steklo; rumenkasto. Vmesni prostor, SE 111. Inv. št. 23650.

10. Dno; steklo; zeleno. Vmesni prostor, kv. 1272, SE 98. Inv. št. 23646.

11. Dno; steklo; zelenkasto. Vmesni prostor, SE 100. Inv. št. 23627.

12. Dno; steklo; zelenkasto. Vmesni prostor, kv. 1272. Inv. št. 23617.

13. Dno; steklo; zelenkasto. Vmesni prostor, SE 107. Inv. št. 23616.

14. Dno; steklo; rumenkasto. Vmesni prostor, kv. 1252, SE 97. Inv. št. 23599.

15. Dno; steklo; prozorno. Vmesni prostor, SE 89. Inv. št. 23597.

16. Dno; steklo; zelenkasto. Vmesni prostor, SE 100. Inv. št. 23628.

17. Dno; steklo; zeleno. Vmesni prostor, kv. 1272, SE 92. Inv. št. 23620.

18. Dno; steklo; zeleno. Vmesni prostor, kv. 1272, SE 92. Inv. št. 23621.

19. Ustje z ročajem; steklo; rumenkasto. Vmesni prostor, kv. 1273/D3, SE 62 (sonda 93). Inv. št. 23672.

20. Ročaj svetilke; steklo; zeleno. Vmesni prostor, kv. 1273/C2, SE 02. Inv. št. 23660.

21. Ustje; steklo; rumenkasto. Vmesni prostor, kv. 1272/C4, SE 02. Inv. št. 23665.

22. Ustje; steklo; rumenkasto. Vmesni prostor, SE 86. Inv. št. 23670.

23. Ročaj; steklo; rumenkasto. Vmesni prostor, SE 86. Inv. št. 23670.

24. Svetilka; steklo; rumenkasto. Vmesni prostor, SE 100. Inv. št. 23634.

25. Ročaj svetilke; steklo; rumeno. Vmesni prostor, kv. 1272, SE 94. Inv. št. 23595.

26. Noga; steklo; prozorno. Vmesni prostor, SE 111. Inv. št. 23607.

27. Ustje; steklo; turkizno. Vmesni prostor, SE 89. Inv. št. 23596.

– Ciglenečki, Milavec 2009, t. 1: 7.

28. Noga; steklo; zelenkasto. Cisterna, kv. 934/ A3, SE 218. Inv. št. 23678.

29. Dno; steklo; zeleno. Cisterna, kv. 934/ C2, SE 101. Inv. št. 23679.

30. Ustje; steklo; rumenkasto. Cisterna, kv. 934/ D2, SE 229. Inv. št. 23677.

Tabla 64

1. Skleda; 2 dela ustja z ostenjem; afriška sigilata; barva zunaj, znotraj in v prelomu: 2,5YR 4/8. Stavba 1, kv. 669/C1, SE 06. Inv. št. 20871, 21559.

– Milavec, Modrijan 2007, sl. 7: 1; Modrijan 2010, sl. 2: 1.

2. Skleda; del ustja z ostenjem; afriška sigilata; barva zunaj, znotraj in v prelomu: 2,5YR 4/8; 3. Stavba 1, kv. 769/B2, SE 04. Inv. št. 21943.

3. Skleda; del ustja z ostenjem; afriška sigilata; barva zunaj, znotraj in v prelomu: 10R 5/8; Stavba 1, kv. 718/B2, SE 10. Inv. št. 20464.

4. Krožnik ali skleda; 3 deli ustja z ostenjem; afriška sigilata; barva zunaj, znotraj in v prelomu: 2,5YR 5/8. Stavba 1, kv. 669/ C1, SE 30. Inv. št. 20625.

– Milavec, Modrijan 2007, sl. 7: 2; Modrijan 2010, sl. 2: 2.

5. Krožnik ali skleda; del ustja in 2 dela ostenja; afriška sigilata; barva zunaj, znotraj in v prelomu: 2,5YR 5/8. Stavba 1, kv. 769/A1, SE 04. Inv. št. 20529.

– Modrijan 2010, sl. 2: 3.

6. Krožnik ali skleda; del ustja z ostenjem in del ostenja; afriška sigilata; barva zunaj, znotraj in v prelomu: 2,5YR 5/8. Stavba 1, kv. 718/D4, SE 36. Inv. št. 20325, 20326.

7. Krožnik ali skleda; del ustja z ostenjem; afriška sigilata; barva zunaj, znotraj in v prelomu: 2,5YR 5/8. Stavba 1, kv. 720/ A3, SE 01. Inv. št. 21684.

8. Krožnik ali skleda; del ustja z ostenjem; afriška sigilata; barva zunaj, znotraj in v prelomu: 2,5YR 6/6, premaz 2,5YR 5/8. Stavba 1, kv. 619/B2, SE 64. Inv. št. 20602.

9. Skleda; del ustja z ostenjem; afriška sigilata; barva zunaj, znotraj in v prelomu: 2,5YR 5/8. Stavba 1, kv. 669/C4, SE 07. Inv. št. 20999.

– Milavec, Modrijan 2007, sl. 9: 1; Modrijan 2010, sl. 3: 13.

10. Krožnik ali skleda; 2 dela dna; afriška sigilata; barva zunaj, znotraj in v prelomu: 2,5YR 5/8; okras: vrbovi listi. Stavba 1, kv. 669/A3, SE 23. Inv. št. 20472.

11. Krožnik ali skleda; del ustja in ostenja; afriška sigilata; barva zunaj, znotraj in v prelomu: 2,5YR 6/8. Stavba 1, kv. 720/ A4, SE 01. Inv. št. 21687.

– Milavec, Modrijan 2007, sl. 9: 2.

Tabla 65

1. Krožnik ali skleda; del dna in ostenja; afriška; barva zunaj, znotraj in v prelomu: 2,5YR 5/8. Stavba 1, kv. 719/B3, SE 07. Inv. št. 21492.

2. Krožnik ali skleda; del dna in ostenja; afriška; barva zunaj, znotraj in v prelomu: 2,5YR 5/8. Stavba 1, kv. 720/A4, SE 01. Inv. št. 21688.

3. Oljenka; del diska; afriška; barva zunaj, znotraj in v prelomu: 2,5YR 6/8; reliefni okras menjajočih se koncentričnih krogov in rombov. Stavba 1, kv. 618/B3, SE 67. Inv. št. 21791.

– Milavec, Modrijan 2007, sl. 7: 3.

4. Oljenka; držaj in del diska; afriška; barva zunaj, znotraj in v prelomu: 2,5YR 6/6; reliefni okras menjajočih se trikotnikov in palmet. Stavba 1, kv. 666/A3, SE 29. Inv. št. 21900.

– Milavec, Modrijan 2007, sl. 7: 4.

5. Oljenka; držaj in del diska; afriška; barva zunaj, znotraj in v prelomu: 2,5YR 6/8; reliefni okras. Stavba 1, kv. 716/D4, SE 23. Inv. št. 21393.

– Ciglenečki 1994b, sl. 4. 1; Milavec, Modrijan 2007, sl. 9.3.

6. Oljenka; imitacija afriške; barva zunaj, znotraj in v prelomu: 10YR 8/4; reliefni okras. Stavba 1, 666/A1 SE 34. Inv. št. 21812.

– Milavec, Modrijan 2007, sl. 9.4.

7. Skleda; 3 deli ustja z ostenjem; afriška namizna; barva zunaj, znotraj in v prelomu: 10R 4/6; Stavba 1, kv. 766/B3, SE 01. Inv. št. 21659.

8. Lonček; deli ustja, ostenja in dna; glazirana; barva zunaj: 5YR 6/8, lošč 2,5Y 4/3; barva znotraj: 5YR 6/8, lošč 2,5Y 6/3; barva v prelomu: 5YR 6/8; okras enojne valovnice; stavba 1, kv. 766/A4, SE 24. Inv. št. 21674, 21772, 21892.

– Modrijan 2009, sl. 1.2: b, sl. 4.1.

9. Lonček; del ustja z ostenjem; barva zunaj: 5YR 6/6, lošč 2,5Y 6/4; barva znotraj: 5YR 6/6, lošč 2,5Y 6/4; barva v prelomu: 5YR 6/6. Stavba 1, kv. 716/C3, SE 23. Inv. št. 21249.

– Modrijan 2009, sl. 1.2.c.

10. Lonec; del dna z ostenjem; glazirana keramika; barva zunaj: 2,5YR 6/6, lošč 10YR 4/2; barva znotraj: 2,5YR 6/6, lošč 10YR 4/2; barva v prelomu: 2,5YR 6/6. Stavba 1, kv. 666/B3, SE 24. Inv. št. 20075.

– Modrijan 2009, sl. 1.2.d.

11. Vrč; del ustja z ročajem; namizna keramika; barva zunaj, znotraj in v prelomu: 7,5YR 7/6; Stavba 1, kv. 666/B1, SE 29. Inv. št. 21702.

12. Vrč; del ustja z ročajem; namizna keramika; barva zunaj, znotraj in v prelomu: 7,5YR 7/6. Stavba 1, SE 669/D2, SE 30. Inv. št. 21043, 21095.

Tabla 66

1. Vrč; namizna keramika; deli ustja, ročaja, ostenja in dna; barva zunaj, znotraj in v prelomu: 7,5YR 7/4. Stavba 1, kv. 666/A1, SE 29. Inv. št. 22185a-c.

2. Vrč; namizna keramika; del ostenja z ročajem in dva dela ostenja; barva zunaj, znotraj in v prelomu 7,5YR 7/6. Stavba 1, kv. 669/B2, SE24. Inv. št. 20904.

3. Vrč; namizna keramika; del ustja in ostenja z ročajem; barva zunaj, znotraj in v prelomu 7,5YR 7/6. Stavba 1, SE 716/ C4, SE 23. Inv. št. 21271.

4. Vrč; namizna keramika; del ustja z ostenjem; barva zunaj, znotraj in v prelomu: rumena. Stavba 1, kv. 619/B3, C3, SE 67. Inv. št. 21696.

5. Vrč; namizna keramika; del ustja z ostenjem; barva zunaj, znotraj in v prelomu: 5YR 6/6. Stavba 1, kv. 817/D2, SE 03. Inv. št. 22093.



6. Lonček; namizna keramika; del ustja z ostenjem; barva zunaj, znotraj in v prelomu: 7,5YR 7/6. Stavba 1, kv. 716/D4, SE 23. Inv. št. 21356.

7. Lonček; namizna keramika; del ustja z ostenjem; barva zunaj, znotraj in v prelomu: 5YR 3/1. Stavba 1, kv. 766/A3, SE 23. Inv. št. 20659.

8. Lonček; namizna keramika; del ustja z ostenjem; barva zunaj, znotraj in v prelomu: 7,5YR 7/6. Stavba 1, kv. 667/A1 A2, SE 06. Inv. št. 20748.

9. Lonček; namizna keramika; del ustja z ostenjem; barva zunaj, znotraj in v prelomu: 7,5YR 6/6. Stavba 1, kv. 815/D1, SE 14. Inv. št. 22006.

10. Lonček; namizna keramika; del ustja z ostenjem; barva zunaj, znotraj in v prelomu: 5YR 5/8. Stavba 1, kv. 667/A4. Inv. št. 21641.

11. Posoda; namizna keramika; del ostenja; barva zunaj in znotraj; oranžna; v prelomu: siv; okras: rahli široki vzporedni žlebovi. Stavba 1, kv. 719/D1, SE 26. Inv. št. 21636.

12. Vrč; namizna keramika; del ročaja; barva zunaj, znotraj in v prelomu: 10YR 8/3; Stavba 1, kv. 719/C2, SE 26. Inv. št. 21557.

13. Vrč; namizna keramika; del ročaja; barva zunaj, znotraj in v prelomu: 7,5YR 8/4. Stavba 1, kv. 619/B2, SE 34. Inv. št. 21697.

14. Vrč; namizna keramika; del spiralno narebrenega ročaja; barva zunaj, znotraj in v prelomu: 7,5YR 7/4. Stavba 1, kv. 720/A3, SE 07. Inv. št. 21689.

15. Vrč; namizna keramika; del ročaja; barva zunaj, znotraj in v prelomu: 7,5YR 8/4. Stavba 1, kv. 666/D4, SE 06. Inv. št. 20849.

16. Posoda; namizna keramika; del dna in ostenja; barva zunaj, znotraj in v prelomu: 5YR 6/8. Stavba 1, kv. 668/D3, SE 29. Inv. št. 22066.

17. Posoda; namizna keramika; del dna; barva zunaj, znotraj in v prelomu: 5YR 6/8. Stavba 1, kv. 669/B2, SE 24. Inv. št. 20907, 22090.

18. Posoda; namizna keramika; del dna in ostenja; barva zunaj, znotraj in v prelomu: 5YR 6/6. Stavba 1, kv. 817/D3, SE 03. Inv. št. 22103.

#### Tabla 67

1. Amfora; ustje in del ostenja; afriška; barva zunaj, znotraj in v prelomu: 2,5YR 5/6. Stavba 1, kv. 719/C1, SE 29a. Inv. št. 21526.

– Modrijan 2010, sl. 2: 4.

2. Amfora; ustje in del ostenja; afriška; barva zunaj in znotraj: 5YR 6/2; barva v prelomu: 10YR 5/6. Stavba 1, kv. 717/C3, SE 10. Inv. št. 21942.

3. Amfora; ustje in del ostenja; afriška; barva zunaj in znotraj: 2,5YR 6/8; barva v prelomu: 2,5YR 6/8-2,5YR 6/2-2,5YR 6/8. Stavba 1, kv. 668/D2, SE 29. Inv. št. 21918.

4. Amfora; ustje in del ostenja; afriška; barva zunaj in znotraj: 5YR 6/2; barva v prelomu: 2,5YR 6/8. Stavba 1, kv. 666/A2, SE 56. Inv. št. 21725.

– Modrijan 2010, sl. 2: 5.

5. Amfora; ustje in del ostenja; afriška; barva zunaj: 10YR 8/2; barva znotraj: 7,5YR 8/4; barva v prelomu: 7,5YR 7/3. Stavba 1, kv. 668/B1, SE 06. Inv. št. 22183.

– Milavec, Modrijan 2007, sl. 7: 5.

6. Amfora; ustje in del ostenja; afriška; barva zunaj in znotraj: 10YR 8/21; barva v prelomu: 7,5YR 8/4. Stavba 1, kv. 716/C1, SE 06. Inv. št. 21561.

– Modrijan 2010, sl. 2: 6.

7. Amfora; konica; afriška; barva zunaj: 2,5YR 6/6; barva znotraj in v prelomu: 2,5YR 5/6. Stavba 1, kv. 766/C4, SE12. Inv. št. 20002.

– Ciglencečki 1994b, sl. 4: 4.

8. Amfora; konica; afriška; barva zunaj 2,5YR 6/8 (premaz 7,5YR 7/3; barva znotraj in v prelomu: 2,5YR 6/8. Stavba 1, kv. 768/C3, SE 03. Inv. št. 21865.

9. Amfora; del konice z ostenjem; afriška; barva zunaj, znotraj in v prelomu: 2,5YR 5/6. Stavba 1, kv. 666/A4, SE57. Inv. št. 22127.

10. Amfora; del konice z ostenjem; afriška; barva zunaj: 2,5YR 6/2; barva znotraj in v prelomu: 2,5YR 5/6. Stavba 1, kv. 669/C4, SE 01. Inv. št. 20985.

– Ciglencečki 1994, sl. 4: 6.

– Milavec, Modrijan 2007, sl. 7: 6.

#### Tabla 68

1. Amfora; del ustja z ostenjem; afriška; barva zunaj, znotraj in v prelomu: 7,5YR 7/3. Stavba 1, kv. 669/B3, SE29a. Inv. št. 20930.

2. Amfora; del ustja z ostenjem; afriška; barva zunaj: 7,5YR 4/3; barva znotraj: 7,5YR 7/6; barva v prelomu: 2,5YR 5/8. Stavba 1, kv. 669/C3, SE 01. Inv. št. 21030.

– Milavec, Modrijan 2007, sl. 10: 6; Modrijan 2010, sl. 3: 11.

3. Amfora; konica in del ostenja; afriška; barva zunaj, znotraj in v prelomu: 7,5YR 7/4. Stavba 1, kv. 568/B1, SE 34. Inv. št. 21514.

4. Amfora; del ostenja z ročajem; afriška; barva zunaj: 2,5YR 5/8; barva znotraj in v prelomu: 7,5YR 7/7. Stavba 1, kv. 718/A3, SE 11. Inv. št. 20380.

5. Amfora; del ostenja z ročajem; afriška; barva zunaj in znotraj: 7,5YR 8/2; barva v prelomu: 7,5YR 7/4. Stavba 1, kv. 718/C1, SE 10. Inv. št. 20493.

6. Amfora; del vratu in ostenja; afriška; barva zunaj, znotraj in v prelomu: 2,5YR 6/8. Izven izkopnega polja.

– Ciglencečki 1994a, t. 1: 1.

#### Tabla 69

1. Amfora; del ročaja; afriška; barva zunaj in znotraj: 2,5YR 6/8; barva v prelomu: 2,5YR 6/1. Stavba 1, kv. 619/D1, SE 67. Inv. št. 21908.

2. Amfora; del ročaja; afriška; barva zunaj in znotraj: 5YR 6/2; barva v prelomu: 2,5YR 5/8. Stavba 1, kv. 816/A1, SE 68. Inv. št. 22026.

3. Amfora; del ostenja z nastavkom ročaja; afriška; barva zunaj: 7,5YR 8/2; barva znotraj in v prelomu: 2,5YR 5/6. Stavba 1, kv. 669/A2, SE 29. Inv. št. 21959.

4. Amfora; 3 deli ustja z ostenjem in dvema ročajema; vzhodnomediterska; barva zunaj: 10YR 8/3; barva znotraj in v prelomu: 7,5YR 7/6. Stavba 1, kv. 669/ A3, SE 26. Inv. št. 20883, 21122, 21469.

– Ciglencečki 1994b, sl. 4: 3; Milavec, Modrijan 2007, sl. 10.1; Modrijan 2010, sl. 3: 1.

5. Amfora; 30 delov ustja in ostenja; vzhodnomeditranska; barva zunaj: 5YR 6/8; barva znotraj: 5YR 5/8; barva v prelomu: 5YR 7/3; gosti vzporedni žlebovi. Stavba 1, kv. 669/C3, C4, SE 01. Inv. št. 21033-21037, 20949.

Tabla 70

1. Amfora; del ustja z ostenjem; vzhodnomeditranska; barva zunaj, znotraj in v prelomu: 5YR 6/6. Stavba 1, kv. 719/D3, SE26. Inv. št. 21660.

– Modrijan 2010, sl. 3: 3.

2. Amfora; del ustja z ostenjem; vzhodnomeditranska; barva zunaj, znotraj in v prelomu: 10YR 8/3. Stavba 1, kv. 666/C3, SE 07. Inv. št. 20626.

– Ciglencečki 1994b, sl. 4.2; Modrijan 2010, sl. 3: 4.

3. Amfora; gumbast zaključek; vzhodnomeditranska; barva zunaj, znotraj in v prelomu: 5YR 6/6. Stavba 1, kv. 669/C1, SE 07. Inv. št. 21057.

– Milavec, Modrijan 2007, sl. 10. 3.

4. Amfora; gumbast zaključek; vzhodnomeditranska; barva zunaj, znotraj in v prelomu: 5YR 5/8. Stavba 1, kv. 669/C4, SE 01. Inv. št. 21017.

– Milavec, Modrijan 2007, sl. 10.2; Modrijan 2010, sl. 3: 6.

5. Amfora; deli ustja, ostenja in ročaja; vzhodnomeditranska; barva zunaj: 7,5YR 7/6; barva znotraj: 5YR 6/6; barva v prelomu: 7,5YR 7/6 do 5YR 6/6; gosti vzporedni žlebovi. Stavba 1, kv. 669/C4, SE 07. Inv. št. 21002, 21112, 21116.

– Milavec, Modrijan 2007, sl. 10.4.

Tabla 71

1. Amfora; konica in del ostenja; vzhodnomeditranska; barva zunaj, znotraj in v prelomu: 5YR 7/4. Stavba 1, kv. 716/B3, SE 23. Inv. št. 21205.

– Ciglencečki 1994b, sl. 4: 5; Milavec, Modrijan 2007, sl. 10.5; Modrijan 2010, sl. 3: 12.

2. Amfora; del ostenja z ročajem; vzhodnomeditranska; barva zunaj: 7,5YR 7/3; barva znotraj in v prelomu: 5YR 6/8; široki plitvi vzporedni žlebovi. Stavba 1, kv. 769/A1, SE 03. Inv. št. 21899.

3. Amfora; 5 delov ostenja; vzhodnomeditranska; barva zunaj, znotraj in v prelomu: 2,5YR 6/6; široki vzporedni žlebovi. Stavba 1, kv. 719/B4, SE 05. Inv. št. 21520, 21521, 21525.

4. Amfora; dva dela ostenja; vzhodnomeditranska; barva zunaj, znotraj in v prelomu: 7,5YR 7/6; široki vzporedni žlebovi. Stavba 1, kv. 716/C3, SE 23. Inv. št. 21254.

5. Amfora; del ostenja z ročajem; vzhodnomeditranska; barva zunaj: 10YR 7/8; barva znotraj in v prelomu: 5YR 7/6; široki vzporedni žlebovi; Stavba 1, kv. 717/C1, SE 24. Inv. št. 21396.

– Modrijan 2010, sl. 3: 5.

6. Amfora; del ostenja; vzhodnomeditranska; barva zunaj, znotraj in v prelomu: 2,5YR 6/6; gosti vzporedni žlebovi. Stavba 1, kv. 666/D1. Inv. št. 20647.

Tabla 72

1. Amfora; ročaj; vzhodnomeditranska; barva zunaj: 7,5YR 7/6; barva znotraj: 5YR 6/6; barva v prelomu: 7,5YR 7/6 - 5YR 6/6. Stavba 1, kv. 668/A3, SE 26. Inv. št. 21460.

2. Amfora; vzhodnomeditranska; del ostenja z ročajem; vzhodnomeditranska; barva zunaj, znotraj in v prelomu: 7,5YR 7/4. Stavba 1, kv. 720/A2, SE 01. Inv. št. 21680.

3. Amfora; del ostenja z ročajem; vzhodnomeditranska; barva zunaj, znotraj in v prelomu: 2,5YR 6/4; široki vzporedni žlebovi. Stavba 1, kv. 668/D4, SE 08. Inv. št. 20839-20841.

4. Amfora; del ostenja z ročajem; vzhodnomeditranska; barva zunaj, znotraj in v prelomu: 2,5YR 5/8; gosti vzporedni žlebovi. Stavba 1, kv. 666/D1, SE 34. Inv. št. 22043.

5. Amfora; del ostenja; vzhodnomeditranska; barva zunaj: 10YR 7/4; barva znotraj in v prelomu: 7,5YR 7/4; gosti vzporedni žlebovi. Stavba 1, kv. 669/C1, SE 07. Inv. št. 20895, 21058.

6. Amfora; del ostenja; vzhodnomeditranska; barva zunaj: 10YR 7/8; barva znotraj: 5YR 7/6; barva v prelomu: 10YR 7/8; gosti vzporedni žlebovi. Stavba 1, kv. 718/B2, SE 10. Inv. št. 20465.

7. Amfora; 6 delov ostenja; vzhodnomeditranska; barva zunaj, znotraj in v prelomu: 10YR 7/3; gosti vzporedni žlebovi. Stavba 1, kv. 716/B1, SE 23. Inv. št. 21141, 21190, 21199.

8. Amfora; del ostenja; vzhodnomeditranska; barva zunaj: 10YR 7/4; barva znotraj: 2,5YR 6/8; barva v prelomu: 10YR 7/4-2,5YR6/8; gosti vzporedni žlebovi. Stavba 1, kv. 666/B3, SE 06. Inv. št. 20604.

– Modrijan 2010, sl. 3: 8.

9. Amfora; 2 dela ostenja; vzhodnomeditranska; barva zunaj: 7,5YR 8/4; barva znotraj in v prelomu: 7,5YR 7/6; gosti vzporedni žlebovi. Stavba 1, kv. 666/D2, SE 23. Inv. št. 20667, 20692.

– Modrijan 2010, sl. 3: 7.

Tabla 73

1. Amfora; del ostenja; vzhodnomeditranska; barva zunaj: 7,5YR 8/4; barva znotraj in v prelomu: 7,5YR 7/6; gosti vzporedni žlebovi. Stavba 1, kv. 815/D3, SE 14. Inv. št. 22011.

2. Amfora; 2 dela ostenja; vzhodnomeditranska; barva zunaj; 7,5YR 8/4; barva znotraj in v prelomu: 7,5YR 7/6; gosti vzporedni žlebovi. Stavba 1, kv. 669/D3,D4, SE 07. Inv. št. 21109, 21110.

3. Amfora; del ostenja; vzhodnomeditranska; barva zunaj: 10YR 7/8; barva znotraj in v prelomu: 5YR 7/6; gosti vzporedni žlebovi. Stavba 1, kv. 766/A1, SE 23. Inv. št. 21715.

4. Amfora; del ostenja; vzhodnomeditranska; barva zunaj in v prelomu: 10YR 7/8; barva znotraj: 5YR 7/6; gosti vzporedni žlebovi. Stavba 1, kv. 669, SE 06. Inv. št. 20801.

5. Amfora; del ostenja; vzhodnomeditranska; barva zunaj; 7,5YR 8/4; barva znotraj in v prelomu: 7,5YR 7/6; široki vzporedni žlebovi. Stavba 1, kv. 716/B3. Inv. št. 21198, 21211.

6. Amfora; del ostenja; vzhodnomeditranska; barva zunaj, znotraj in v prelomu: 5YR 6/6; široki vzporedni žlebovi. Stavba 1, kv. 716/A3, SE 23. Inv. št. 21172.

7. Amfora; del ostenja; vzhodnomeditranska; barva zunaj, znotraj in v prelomu: 5YR 6/6; široki vzporedni žlebovi. Stavba 1, kv. 719/A1, SE 23. Inv. št. 20685.

8. Amfora; del ostenja; vzhodnomeditranska; barva zunaj, znotraj in v prelomu: 5YR 6/6; široki vzporedni žlebovi. Stavba 1, kv. 716/A2, SE 06. Inv. št. 20473.

9. Amfora; del ostenja; vzhodnomeditranska; barva zunaj, znotraj in v prelomu: 7,5YR 6/6; široki vzporedni žlebovi. Stavba 1, kv. 666/D2, SE 23. Inv. št. 20668.

10. Amfora; del ostenja; vzhodnomediteranska; barva zunaj, znotraj in v prelomu: 7,5YR 7/3; široki vzporedni žlebovi. Stavba 1, kv. 716/A3 SE 23. Inv. št. 21169.

11. Amfora; del ostenja; vzhodnomediteranska; barva zunaj, znotraj in v prelomu: 2,5YR 7/6; široki vzporedni žlebovi. Stavba 1, kv. 716/C3, SE 23. Inv. št. 21255.

12. Amfora; del ostenja; vzhodnomediteranska; barva zunaj, znotraj in v prelomu: 5YR 5/6; široki vzporedni žlebovi. Stavba 1, kv. 666/C2, SE 23. Inv. št. 21214.

13. Amfora; del ostenja; vzhodnomediteranska; barva zunaj, znotraj in v prelomu: 2,5YR 6/6; široki vzporedni žlebovi. Stavba 1, kv. 666/B4, SE 06. Inv. št. 20611.

14. Amfora; del ostenja; vzhodnomediteranska; barva zunaj, znotraj in v prelomu: 5YR 6/7; široki vzporedni žlebovi. Stavba 1, kv. 768/C3 C4, SE 01. Inv. št. 21862.

15. Amfora; del ostenja; vzhodnomediteranska; barva zunaj, znotraj in v prelomu: 2,5YR 5/6; široki vzporedni žlebovi. Stavba 1, kv. 668/D4, SE 08. Inv. št. 20842.

16. Amfora ali vrč; del ostenja; vzhodnomediteranska; barva zunaj, znotraj in v prelomu: 2,5YR 6/6; široki vzporedni žlebovi. Stavba 1, kv. 666/B3, SE 06. Inv. št. 20603.

Tabla 74

1. Skleda; del ustja z ostenjem; groba keramika; barva zunaj, znotraj in v prelomu: črna; dodatki: apnenec (drobna, zmerna); površina: trda; žlebljenje, enolinijska valovnica. Stavba 1, kv. 718/A3, A4, SE 21. Inv. št. 20304.

2. Skleda; del ustja z ostenjem; groba keramika; barva zunaj, znotraj in v prelomu: rumena; dodatki: apnenec (drobna, zmerna); površina: trda; metličenje, enolinijska valovnica. Stavba 1, kv. 718/A2, SE 10. Inv. št. 20351.

3. Skleda; del ustja z ostenjem; groba keramika; barva zunaj, znotraj in v prelomu: svetlo rjava; dodatki: apnenec (drobna, redka); površina: trda; žlebljenje. Stavba 1, kv. 769/B1, SE 01. Inv. št. 21935.

4. Skleda; del ustja in ostenje; groba keramika; barva zunaj, znotraj in v prelomu: črna; dodatki: apnenec (drobna, redka); površina: trda; metličenje. Stavba 1, kv. 717/B3. Inv. št. 20578.

5. Skleda; del ustja z ostenjem; groba keramika; barva zunaj, znotraj in v prelomu: rjava in črna lisasta; dodatki: apnenec (fina, zmerna); površina: mehka. Stavba 1, kv. 767/D4. Inv. št. 20233.

6. Skleda; del ustja z ostenjem; groba keramika; barva zunaj, znotraj in v prelomu: svetlo rjava; dodatki: apnenec (fina, redka); površina: trda; žlebljenje, enolinijska valovnica. Stavba 1, kv. 718/B1, SE 08. Inv. št. 20808.

7. Skleda; del ustja z ostenjem; groba keramika; barva zunaj, znotraj in v prelomu: svetlo rjava; dodatki: apnenec (drobna, zmerna); površina: mehka; žlebljenje. Stavba 1, kv. 769/B1, SE 01. Inv. št. 21936.

8. Skleda; del ustja z ostenjem; groba keramika; barva zunaj, znotraj in v prelomu: črna; dodatki: apnenec (drobna, zmerna); površina: mehka; metličenje, enolinijska valovnica. Stavba 1, kv. 765/D1, SE 06. Inv. št. 21706.

9. Skleda; del ustja iz ostenjem; groba keramika; barva zunaj, znotraj in v prelomu: siva; dodatki: apnenec (drobna, zmerna); površina: trda; enolinijska valovnica; vrez. Stavba 1, kv. 716/C4, SE 23. Inv. št. 21272.

– Modrijan 2010, sl. 4: 10.

10. Skleda; del ustja z ostenjem; groba keramika; barva zunaj, znotraj in v prelomu: rjava; dodatki: apnenec (drobna, zmerna); površina: trda. Stavba 1, kv. 668/D3, SE 24. Inv. št. 21409.

Tabla 75

1. Skleda; del ustja z ostenjem; groba keramika; barva zunaj, znotraj in v prelomu: črna; dodatki: apnenec (drobna, zmerna); površina: mehka, rahlo porozna. Stavba 1, kv. 667, 717. SE 01. Inv. št. 20856.

2. Skleda; del ustja z ostenjem; groba keramika barva zunaj, znotraj in v prelomu: črna; dodatki: apnenec (drobna, zmerna); površina: mehka, porozna. Stavba 1, kv. 667/A4, SE 23. Inv. št. 20711.

3. Skleda; del ustja z ostenjem; groba keramika; barva zunaj, znotraj in v prelomu: rjava; dodatki: apnenec (fina, zmerna); površina: trda; metličenje. Stavba 1, kv. 667/C4, SE 01. Inv. št. 20733.

4. Skleda; del ustja z ostenjem; groba keramika; barva zunaj in znotraj: svetlo rjava; barva v prelomu: svetlo rjavo-črno-svetlo rjava; dodatki: apnenec (drobna, redka); površina: mehka, rahlo porozna; enolinijska valovnica. Stavba 1, kv. 716/D2, SE23. Inv. št. 21310.

5. Skleda; del ustja z ostenjem; groba keramika; barva zunaj, znotraj in v prelomu: rjava; dodatki: apnenec (drobna, redka); površina: trda; dve enolinijski valovnici, vrez. Stavba 1, kv. 668/D3, SE 08. Inv. št. 20832.

6. Skleda; 2 dela ustja z ostenjem; groba keramika; barva zunaj, znotraj in v prelomu: črna; dodatki: apnenec (fina, zmerna), sljuda (zelo fina, zmerna); površina: trda. Stavba 1, kv. 719/D1, SE 33. Inv. št. 21643, 20822.

7. Skleda; del ustja z ostenjem; groba keramika; barva zunaj, znotraj in v prelomu: rjava; dodatki: apnenec (drobna, redka); površina: mehka, rahlo porozna. Stavba 1, kv. 766/A2, SE23. Inv. št. 21739.

– Modrijan 2010, sl. 5: 1.

8. Skleda; del ustja z ostenjem; groba keramika; barva zunaj, znotraj in v prelomu: siva; dodatki: apnenec (fina, zmerna); površina: trda; metličenje. Stavba 1, kv. 817, SE 03. Inv. št. 22162.

9. Skleda; del ustja z ostenjem; groba keramika; barva zunaj, znotraj in v prelomu: rjava; dodatki: apnenec (drobna, zmerna); površina: trda. Stavba 1, kv. 717/A4, SE 36. Inv. št. 20255.

10. Skleda; del ustja z ostenjem; groba keramika; barva zunaj, znotraj in v prelomu: rjava, dodatki: apnenec (fina, redka), sljuda (zelo fina, redka); površina: trda; vrezi. Stavba 1, kv. 717/B3, SE 78. Inv. št. 20564.

– Modrijan 2010, sl. 4: 11.

Tabla 76

1. Skleda; del ustja z ostenjem; groba keramika; barva zunaj, znotraj in v prelomu: svetlo rjava; dodatki: apnenec (drobna, zmerna); površina: trda; metličenje. Stavba 1, kv. 666/B3, SE 50. Inv. št. 21619.

2. Skleda; 3 deli ustja z ostenjem; groba keramika; barva zunaj, znotraj in v prelomu: rjava; dodatki: apnenec (drobna, zmerna); površina: mehka, močno porozna; vrez, enolinijska valovnica. Stavba 1, kv. 816/B2, SE 09. Inv. št. 20057.

3. Skleda; 5 delov ustja z ostenjem; groba keramika; barva zunaj, znotraj in v prelomu: rjava; dodatki: apnenec (drobna, redka); površina: trda; metličenje. Stavba 1, kv. 718/A2, SE10. Inv. št. 20512.

– Modrijan 2010, sl. 6: 5.

4. Skleda; del ustja z ostenjem; groba keramika; barva zunaj, znotraj in v prelomu: rjava; dodatki: apnenec (groba, zmerna); površina: mehka, porozna; metličenje. Stavba 1, kv. 717/B4, SE 10. Inv. št. 20282.

5. Skleda; del ustja z ostenjem; groba keramika; barva zunaj: rjava; barva znotraj in v prelomu: črna; dodatki: apnenec (drobna, redka); površina: mehka, porozna; vrezi. Stavba 1, kv. 666/D1, SE 23. Inv. št. 20649.

6. Skleda; del ustja z ostenjem; groba keramika; barva zunaj, znotraj in v prelomu: siva; dodatki: apnenec (drobna, redka); površina: trda; vrezi. Stavba 1. 20348.

7. Skleda; deli ustja z ostenjem; groba keramika; barva zunaj, znotraj in v prelomu: rjava; dodatki: apnenec (drobna, zmerna); površina: mehka, porozna; vrezi. Stavba 1, kv. 717/D4, SE 21. Inv. št. 20279, 20280, 20281.

8. Skleda; del ustja z ostenjem; groba keramika; barva zunaj, znotraj in v prelomu: oranžna; dodatki: apnenec (drobna, obilna); površina: mehka, porozna; metličenje. Stavba 1, kv. 719/B2, SE 32. Inv. št. 21534.

9. Skleda; del ustja z ostenjem; groba keramika; barva zunaj in znotraj: oranžna; barva v prelomu: oranžno-sivo-oranžna; dodatki: apnenec (drobna, redka); površina: trda; vrezi. Stavba 1, kv. 717/C2, SE 10. Inv. št. 20286.

10. Skleda; 2 dela ustja in 9 delov ostenja; groba keramika; barva zunaj, znotraj in v prelomu: rjava; dodatki: apnenec (drobna, zmerna); površina: mehka, porozna; enolinijska valovnica, vrezi. Stavba 1, kv. 816/A2, SE 09. Inv. št. 20020.

11. Skleda; del ustja z ostenjem; groba keramika; barva zunaj, znotraj in v prelomu: oranžna; dodatki: apnenec (fina, zmerna); površina: mehka; metličenje. Stavba 1, kv. 768/D2, SE 05. Inv. št. 21985.

12. Skleda; del ustja z ostenjem; groba keramika; barva zunaj, znotraj in v prelomu: svetlo rjava; dodatki: apnenec (drobna, zmerna); površina: mehka, porozna; metličenje. Stavba 1, kv. 718/1, SE 10. Inv. št. 20462.

13. Skleda; del ustja in ostenja; groba keramika; barva zunaj, znotraj in v prelomu: oranžna; dodatki: apnenec (drobna, zmerna); površina: trda; Stavba 1, kv. 719/B4. Inv. št. 21500.

14. Skleda; 3 deli ustja z ostenjem in del ostenja; groba keramika; barva zunaj, znotraj in v prelomu: rjava; dodatki: apnenec (drobna, zmerna); površina: mehka, rahlo porozna; metličenje. Stavba 1, kv. 768/C1, SE 10. Inv. št. 20214.

15. Skleda; del ustja z ostenjem; groba keramika; barva zunaj, znotraj in v prelomu: rjava; dodatki: apnenec (drobna, zmerna); površina: mehka; metličenje. Stavba 1, kv. 717/B4, SE 10. Inv. št. 20283.

16. Skleda; del ustja z ostenjem; groba keramika; barva zunaj, znotraj in v prelomu: rumena; dodatki: apnenec (drobna, redka); površina: trda; enolinijska valovnica. Stavba 1, kv. 766/B2, SE 23. Inv. št. 21798.

17. Skleda; del ustja z ostenjem; groba keramika; barva zunaj, znotraj in v prelomu: oranžna; dodatki: apnenec (drobna, zmerna); površina: mehka, porozna; enolinijska valovnica. Stavba 1, kv. 815/D2, SE 14. Inv. št. 22008.

Tabla 77

1. Skleda; del ustja z ostenjem; groba keramika; barva zunaj in znotraj: svetlo rjava; barva v prelomu: črna; dodatki: apnenec (fina, obilna), sljuda (zelo fina, obilna); površina: trda; TS 1; enolinijska valovnica, vrez. Stavba 1, kv. 766/C4, SE 12. Inv. št. 20090.

2. Skleda; del ustja z ostenjem; groba keramika; barva zunaj, znotraj in v prelomu: svetlo rjava; dodatki: apnenec (drobna, zmerna); površina: trda; TS 2; enolinijska valovnica, vrez. Stavba 1, kv. 717/D1, SE 21. Inv. št. 21322.

– Modrijan 2010, sl. 5: 3.

3. Skleda; del ustja z ostenjem; groba keramika; barva zunaj in znotraj: temno rjava; barva v prelomu: črna; dodatki: apnenec (zelo fina, redka); površina: mehka, rahlo porozna; TS 11; metličenje. Stavba 1, kv. 767/D2, SE 21. Inv. št. 21320.

4. Skleda; del ustja z ostenjem; groba keramika; barva zunaj, znotraj in v prelomu: siva; dodatki: apnenec (drobna, zmerna); površina: trda; TS 11; metličenje, dvolinijska valovnica. Stavba 1, kv. 669/D1, SE 30. Inv. št. 21074.

– Modrijan 2010, sl. 2: 10.

5. Skleda; del ustja z ostenjem; groba keramika; barva zunaj in znotraj: svetlo rjava; barva v prelomu: siva; dodatki: apnenec (fina, zmerna); površina: mehka, rahlo porozna; TS 2. Stavba 1, kv. 669/B1, SE 29. Inv. št. 22080.

6. Skleda; del ustja z ostenjem; groba keramika; barva zunaj in znotraj: temno rjava; barva v prelomu: črna; dodatki: apnenec (fina, zmerna); površina: mehka, rahlo porozna; TS 9; enolinijska valovnica. Stavba 1, kv. 815/D2, SE 14. Inv. št. 22009.

– Ciglencečki 1994b, sl. 3: 5.

7. Skleda; del ustja z ostenjem; groba keramika; barva zunaj, znotraj in v prelomu: črna; dodatki: apnenec (fina, zmerna), sljuda (zelo fina, zmerna); površina: trda. Stavba 1, kv. 666/B2, SE 26. Inv. št. 20793, 20785.

– Ciglencečki 1994b, sl. 3: 3.

8. Skleda; del ustja z ostenjem; groba keramika; barva zunaj in znotraj: rjava lisasta; barva v prelomu: črna; dodatki: apnenec (fina, zmerna); površina: mehka, močno porozna; TS 10; metličenje. Stavba 1. Inv. št. 22154.

9. Skleda; del ustja z ostenjem; groba keramika; barva zunaj, znotraj in v prelomu: črna; dodatki: apnenec (drobna, zmerna); površina: mehka, močno porozna; TS 9; enolinijska valovnica, žlebovi. Stavba 1, kv. 666/D1, SE 34. Inv. št. 21276.

11. Skleda; del ustja z ostenjem; groba keramika; barva zunaj, znotraj in v prelomu: črna; dodatki: apnenec (fina, zmerna), nedefinirani svetlo rjavi delci (fina, redka); površina: mehka, močno porozna; TS 9. Stavba 1, kv. 716/A2, SE 23. Inv. št. 21165.

12. Skleda; del ustja z ostenjem; groba keramika; barva zunaj, znotraj in v prelomu: črna; dodatki: apnenec (drobna, zmerna); površina: trda; TS 8; enolinijska valovnica, vrez. Stavba 1, kv. 719/C3, SE 01. Inv. št. 21585.

13. Skleda; del ustja z ostenjem; groba keramika; barva zunaj, znotraj in v prelomu: svetlo rjava; dodatki: apnenec (drobna, zmerna); površina: trda; TS 2; metličenje. Stavba 1, kv. 769/C2, SE 05. Inv. št. 21945.

14. Skleda; del ustja z ostenjem; groba keramika; barva zunaj, znotraj in v prelomu: črna; dodatki: apnenec (fina, zmerna); površina: mehka, močno porozna; TS 9. Stavba 1, kv. 716/C3, SE 23. Inv. št. 21251.

15. Skleda; del ustja z ostenjem; groba keramika; barva zunaj, znotraj in v prelomu: črna; apnenec (drobna, zmerna); površina: trda; TS 8. Stavba 1, kv. 716/D4, SE 23. Inv. št. 21390.

Tabla 78

1. Skleda; del ustja z ostenjem; groba keramika; barva zunaj, znotraj in v prelomu: črna; dodatki: apnenec (drobna, zmerna); površina: trda; TS 8; vbodi. Stavba 1, kv. 666/D1, SE 23. Inv. št. 20652.

2. Skleda; del ustja z ostenjem; groba keramika; barva zunaj, znotraj in v prelomu: črna; dodatki: apnenec (drobna, zmerna); površina: trda; TS 8. Stavba 1, kv. 666/D3, SE 23. Inv. št. 20629.

3. Skleda; del ustja z ostenjem; groba keramika; barva zunaj, znotraj in v prelomu: črna; dodatki: apnenec (drobna, obilna); površina: mehka, drobno porozna; TS 9; enolinijska valovnica. Stavba 1, kv. 766/A2, SE 23. Inv. št. 21754.

4. Skleda; del ustja z ostenjem; groba keramika; barva zunaj, znotraj in v prelomu: rjava; dodatki: apnenec (drobna, zmerna); površina: trda; TS: neopr.; dve enolinijski valovnici. Stavba 1, kv. 769/B2, SE 04. Inv. št. 20572.

5. Skleda; del ustja z ostenjem; groba keramika; barva zunaj, znotraj in v prelomu: svetlo rjava; dodatki: apnenec (fina, zmerna); površina: trda; TS 2; vbodi, glavničenje. Stavba 1, kv. 619/D3, SE 74. Inv. št. 21438.

6. Skleda; del ustja z ostenjem; groba keramika; barva zunaj in znotraj: oranžna; barva v prelomu: siva; dodatki: apnenec (drobna do groba, zmerna); površina: mehka, drobno porozna; TS 11; vbodi. Stavba 1, kv. 817/D2, SE 03. Inv. št. 22081.

7. Skleda; del ustja z ostenjem; groba keramika; barva zunaj, znotraj in v prelomu: svetlo rjava; dodatki: apnenec (drobna, zmerna); površina: trda, rahlo porozna; TS 2; dvojna valovnica. Stavba 1, kv. 669/D3, SE 30. Inv. št. 21111.

8. Skleda; del ustja z ostenjem; groba keramika; barva zunaj, znotraj in v prelomu: svetlo rjava; dodatki: apnenec (drobna, zmerna); površina: trda; TS 2; metličenje. Stavba 1, kv. 719/B2, SE 24. Inv. št. 21488.

9. Skleda; del ustja z ostenja; groba keramika; barva zunaj: črna; barva znotraj in v prelomu: oranžna; dodatki: apnenec (drobna, zmerna); površina: trda; TS 14; dve večlinijski valovnici, metličenje. Stavba 1, kv. 619/D3. Inv. št. 21375.

10. Skleda; del ustja z ostenjem; groba keramika; barva zunaj, znotraj in v prelomu: svetlo rjava; dodatki: apnenec (drobna, zmerna); površina: mehka; TS 2; metličenje. Stavba 1, kv. 669/B2, SE 30. Inv. št. 20939.

11. Skleda; del ustja z ostenjem; groba keramika; barva zunaj, znotraj in v prelomu: rjava; dodatki: apnenec (drobna, zmerna); površina: trda; TS 6; metličenje. Stavba 1, kv. 668/D2, SE 28. Inv. št. 20816.

12. Skleda; del ostenja; groba keramika; barva zunaj, znotraj in v prelomu: rumena; dodatki: apnenec (drobna, zmerna); površina: mehka; TS 2; valovnica, vrez. Stavba 1, kv. D. Inv. št. 21495.

13. Skleda; del ustja z ostenjam; groba keramika; barva zunaj, znotraj in v prelomu: temno siva; dodatki: apnenec (drobna, obilna); površina: trda; TS 8; enolinijska valovnica. Stavba 1, kv. 766/A4, SE 14. Inv. št. 21785.

14. Skleda; del ustja z ostenjem; groba keramika; barva zunaj, znotraj in v prelomu: črna; dodatki: apnenec (drobna,

obilna); površina: mehka; TS 9; vrez. Stavba 1, kv. 669/C3. Inv. št. 21026.

15. Skleda; del ustja z ostenjem; groba keramika; barva zunaj, znotraj in v prelomu: temno siva; dodatki: apnenec (drobna, fina, zmerna); površina: trda; TS 8; metličenje. Stavba 1, kv. 768/B3. Inv. št. 21965.

16. Skleda; del ustja z ostenjem; groba keramika; barva zunaj, znotraj in v prelomu: temno siva; dodatki: apnenec (drobna, obilna); površina: trda; TS 8; valovnica, metličenje. Stavba 1, kv. 717/A2, SE 23a. Inv. št. 20540.

Tabla 79

1. Skleda; del ustja z ostenjem; groba keramika; barva zunaj, znotraj in v prelomu: rjava; dodatek: apnenec (drobna do fina, zmerna); površina: trda; TS 9; metličenje. Stavba 1, kv. 717/D2, SE 11. Inv. št. 20439.

2. Skleda; 2 dela ustja z ostenjem; groba keramika; barva zunaj in znotraj: rjava; barva v prelomu: oranžna; dodatek: apnenec (fina, zmerna); površina: trda; TS 6; vrez, žlebljenje, enolinijska valovnica. Stavba 1, kv. 719/B2, SE 24. Inv. št. 21325, 21489.

3. Skleda; del ustja z ostenjem; groba keramika; barva zunaj in znotraj: črna in rjava; barva v prelomu: siva; apnenec (fina, redka), sljuda (fina, zmerna); površina: trda; TS 15; metličenje. Stavba 1, kv. 668/2, SE 28. Inv. št. 20818.

4. Skleda; del ustja z ostenjem; groba keramika; barva zunaj, znotraj in v prelomu: črna; dodatek: apnenec (fina, zmerna); površina: trda; TS 8; metličenje. Stavba 1, kv. 818/B2, SE 03. Inv. št. 22118.

5. Skleda; del ustja z ostenjem; groba keramika; barva zunaj, znotraj in v prelomu: temno siva; dodatek: apnenec (drobna, obilna); površina: trda; TS 8; metličenje. Stavba 1, kv. 717/A2, SE 23a. Inv. št. 20535.

6. Skleda; 3 deli ustja; groba keramika; barva zunaj, znotraj in v prelomu: svetlo rjava; dodatek: apnenec (drobna, zmerna); površina: trda; TS 2; vrez, enolinijski valovnici. Stavba 1, kv. 719/C2, SE 01. Inv. št. 21540, 21651, 21661.

7. Skleda; del ustja z ostenjem; groba keramika; barva zunaj, znotraj in v prelomu: črna; dodatek: apnenec (fina, zmerna); površina: mehka, rahlo porozna; TS 9; enolinijska valovnica, vrez. Stavba 1, kv. 666/A3, SE 23. Inv. št. 20698.

8. Skleda; del ustja z ostenja; groba keramika; barva zunaj in znotraj: svetlo rjava; barva v prelomu: siva; dodatek: apnenec (fina, redka); površina: trda; TS 1; žleb. Stavba 1, kv. 769/A1, SE 05. Inv. št. 21885.

9. Skleda; del ustja z ostenjem; groba keramika; barva zunaj, znotraj in v prelomu: svetlo rjava; dodatek: apnenec (drobna, zmerna); površina: trda; TS 2; vbodi. Stavba 1, kv. 666/B2, C2. Stavba 1. Inv. št. 21354.

10. Skleda; del ustja z ostenjem; groba keramika; barva zunaj, znotraj in v prelomu: črna; dodatek: apnenec (fina, obilna); barva zunaj, znotraj in v prelomu: črna; površina: trda; TS 8; metličenje. Stavba 1, kv. 719/A1, SE 26. Inv. št. 21403.

11. Skleda; del ustja z ostenjem; groba keramika; barva zunaj, znotraj in v prelomu: črna; dodatek: apnenec (fina, zmerna), sljuda (zelo fina, zmerna); površina: trda; TS 11. Stavba 1, kv. 719/A4. Inv. št. 21427.

12. Skleda; del ustja z ostenjem; groba keramika; barva zunaj, znotraj in v prelomu: temno siva; dodatek: apnenec

(drobna do groba, zmerna); površina: trda; TS 14. Stavba 1, kv. 666/A1, SE 29. Inv. št. 22178.

13. Skleda; del ustja z ostenjem; groba keramika; barva zunaj, znotraj in v prelomu: črna; dodatek: apnenec (fina do drobna, zmerna); površina: mehka, rahlo porozna; TS 9; metličenje. Stavba 1, kv. 716/B3. Inv. št. 21571.

14. Skleda; del ustja z ostenjem; groba keramika; barva zunaj, znotraj in v prelomu: črna; dodatek: apnenec (drobna, obilna); površina: trda; TS 8; metličenje. Stavba 1, kv. 817/1, SE 08. Inv. št. 20245.

15. Skleda; del ustja z ostenjem; groba keramika; barva zunaj, znotraj in v prelomu: črna; dodatek: apnenec (fina, obilna); površina: mehka, rahlo porozna; TS 9; enolinijska valovnica. Stavba 1, kv. 666/D3, SE 23. Inv. št. 20630.

16. Skleda; del ustja z ostenjem; groba keramika; barva zunaj, znotraj in v prelomu: svetlo rjava; dodatek: apnenec (drobna, zmerna); površina: trda; TS 2; enolinjska valovnica, vrezi. Stavba 1, kv. 666/A1, SE 29. Inv. št. 22181.

#### Tabla 80

1. Skleda; del ustja z ostenjem; groba keramika; barva zunaj, znotraj in v prelomu: temno siva; dodatki: apnenec (drobna, zmerna); površina: trda; TS 8; metličenje, vrezi, večlinijska valovnica. Stavba 1, kv. 666/D4, SE 24. Inv. št. 22059.

2. Skleda; 2 dela ustja z ostenjem; groba keramika; barva zunaj, znotraj in v prelomu: rjava; dodatki: apnenec (drobna, zmerna); površina: trda; TS 6. Stavba 1, kv. 718/B4, SE 36a. Inv. št. 20474, 20484.

3. Skleda; del ustja z ostenjem; groba keramika; barva zunaj, znotraj in v prelomu: temno siva; dodatki: apnenec (drobna, zmerna); površina: trda; TS 8; vbodi, enolinijska valovnica. Stavba 1, kv. 817/D2, SE 03. Inv. št. 22071.

– Ciglenečki 1994b, sl. 3.6.

4. Skleda; del ustja z ostenjem; groba keramika; barva zunaj, znotraj in v prelomu: črna; dodatki: apnenec (drobna, obilna); površina: trda; TS 8. Stavba 1, kv. 669/A2, SE 29. Inv. št. 21448.

5. Skleda; 2 dela ustja z ostenjem; groba keramika; barva zunaj: temno rjava; barva znotraj: temno siva; barva v prelomu: črna; dodatki: apnenec (drobna, zmerna); površina: mehka, močno porozna; TS 9. Stavba 1, kv. 669/C4, SE 24. Inv. št. 21073.

6. Skleda; del ustja z ostenjem; groba keramika; barva zunaj, znotraj in v prelomu: rjava; dodatki: apnenec (drobna, zmerna); površina: mehka, močno porozna; TS 14; vbodi, žlebljenje, enolinijska valovnica. Stavba 1, kv. 669/C2, SE 24. Inv. št. 20969.

7. Skleda; del ustja z ostenjem; groba keramika; barva zunaj, znotraj in v prelomu: temno siva; dodatki: apnenec (drobna do groba, zmerna); površina: trda; TS 8. Stavba 1, kv. 669/A1, SE 29. Inv. št. 21334.

8. Skleda; del ustja z ostenjem; groba keramika; barva zunaj, znotraj in v prelomu: temno siva; dodatki: apnenec (drobna, zmerna); površina: trda; TS 14; metličenje, enolinijska valovnica. Stavba 1, kv. 666/C2, SE 24. Inv. št. 20618.

9. Skleda; del ustja z ostenjem; groba keramika; barva zunaj, znotraj in v prelomu: temno siva; dodatki: apnenec (drobna, zmerna); površina: trda; TS 8; večlinijska valovnica, metličenje. Stavba 1, kv. 719/B4, SE 04. Inv. št. 21505.

10. Skleda; del ustja z ostenjem; groba keramika; barva zunaj, znotraj in v prelomu: rjava; dodatki: apnenec (drobna, zmerna); površina: mehka; TS 5; večlinijska valovnica. Stavba 1, kv. 669/A2, SE 29. Inv. št. 21470.

11. Skleda; del ustja z ostenjem; groba keramika; barva zunaj, znotraj in v prelomu: oranžna; dodatki: apnenec (drobna do groba, zmerna); površina: trda, rahlo porozna; TS 2; dve enolinijski valovnici. Stavba 1, kv. 719/B1, SE 24. Inv. št. 22023.

12. Skleda; del ustja z ostenjem; groba keramika; barva zunaj in znotraj: oranžna; barva v prelomu: siva; dodatki: apnenec (drobna, zmerna); površina: mehka, rahlo porozna; TS 1; vbodi, metličenje, enolinijska valovnica. Stavba 1, kv. 817. Inv. št. 22042.

13. Skleda; 3 deli ustja z ostenjem; groba keramika; barva zunaj, znotraj in v prelomu: črna; dodatki: apnenec (drobna, zmerna); površina: trda; TS 8; vrezi, valovnica. Stavba 1, kv. 668/D3, SE 24. Inv. št. 20761, 20707, 21662.

14. Skleda; del ustja z ostenjem; groba keramika; barva zunaj, znotraj in v prelomu: črna; dodatki: apnenec (zelo fina, redka); površina: mehka, rahlo porozna; TS 9; enolinijska valovnica. Stavba 1, kv. 669/A1, SE 29. Inv. št. 20538.

15. Skleda; del ustja z ostenjem; groba keramika; barva zunaj, znotraj in v prelomu: svetlo rjava; dodatki: apnenec (drobna, zmerna); površina: trda; TS 2; metličenje. Stavba 1, kv. 767/A1, SE 36. Inv. št. 20154.

16. Skleda; del ustja z ostenjem; groba keramika; barva zunaj, znotraj in v prelomu: črna; dodatki: apnenec (drobna, zmerna); površina: trda; TS 8; enolinijska valovnica. Stavba 1, kv. 669/B3, SE 24. Inv. št. 20954.

#### Tabla 81

1. Skleda; del ustja z ostenjem; groba keramika; barva zunaj in znotraj: črna; barva v prelomu: oranžna; dodatki: apnenec (drobna, redka); površina: trda; TS 14; vbodi, metličenje, enolinijska valovnica. Stavba 1, kv. 769/B1, SE 04. Inv. št. 20568.

2. Skleda; ustja z ostenjem; groba keramika; barva zunaj, znotraj in v prelomu: temno siva; dodatki: apnenec (drobna, obilna); površina: trda; TS 8; vbodi. Stavba 1, kv. 817/D3, SE 03. Inv. št. 22102.

3. Skleda; del ustja z ostenjem; groba keramika; barva zunaj in znotraj: črna; barva v prelomu: oranžna; dodatki: apnenec (drobna, redka); površina: trda; TS 14; enolinijska valovnica. Stavba 1, kv. 766/A4, SE 24. Inv. št. 21773.

4. Skleda; del ustja z ostenjem; groba keramika; barva zunaj: svetlo rjava; barva znotraj: svetlo rjava in siva; barva v prelomu: siva; dodatki: apnenec (drobna, zmerna); površina: mehka, rahlo porozna; TS neopr. Stavba 1, kv. 768/C4 D, SE 03. Inv. št. 21882.

5. Skleda; del ustja z ostenjem; groba keramika; barva zunaj: siva in rjava; barva znotraj in v prelomu: siva; dodatki: apnenec (fina, zmerna), sljuda (zelo fina, zmerna); površina: trda; TS 15. Stavba 1, kv. 769/A2, SE 03. Inv. št. 21920.

6. Skleda; del ustja z ostenjem; groba keramika; barva zunaj: črna; barva znotraj: rjava; barva v prelomu: oranžna; dodatki: apnenec (drobna, zmerna); površina: trda; TS 14. Stavba 1, kv. 719/B4, SE 04. Inv. št. 21507.

7. Skleda; del ustja z ostenjem in dnom; groba keramika; barva zunaj, znotraj in v prelomu: siva; dodatki: apnenec (groba, zmerna); površina: trda; TS 14; vrezi, enolinijska valovnica. Stavba 1, kv. 669/A2, SE 29. Inv. št. 21663, 22049.

8. Skleda; del ustja z ostenjem; groba keramika; barva zunaj: rjava; barva znotraj: oranžna; barva v prelomu: rjava; dodatki: apnenec (drobna, zmerna); površina: trda; TS 6; vbodi. Stavba 1, kv. 669/A3, SE 24. Inv. št. 20878.

9. Skleda; del ustja z ostenjem; groba keramika; barva zunaj in znotraj: rjava; barva v prelomu: oranžna; dodatki: apnenec (drobna do groba, redka); površina: mehka; TS 3; vbodi. Stavba 1, kv. 669/C2, SE 30. Inv. št. 20988.

– Modrijan 2010, sl. 2: 11.

10. Skleda; del ustja z ostenjem; groba keramika; barva zunaj in v prelomu: rjava; barva znotraj: oranžna; dodatki: apnenec (drobna, zmerna); površina: trda; TS 6; vrezji. Stavba 1, kv. 666/B4, SE 50. Inv. št. 20546.

11. Skleda; del ustja z ostenjem; groba keramika; barva zunaj, znotraj in v prelomu: rjava; dodatki: apnenec (fina do groba, redka); površina: trda; TS 6; vbodi. Stavba 1, kv. 669/C3, SE 29. Inv. št. 21006.

12. Skleda; del ustja z ostenjem; groba keramika; barva zunaj in znotraj: črna; barva v prelomu: črna in oranžna; dodatki: apnenec (drobna do groba, zmerna); površina: trda; TS 14; vbodi, enolinijska valovnica. Stavba 1, kv. 719/C3, SE 04. Inv. št. 20776.

13. Skleda; del ustja z ostenjem; groba keramika; barva zunaj, znotraj in v prelomu: črna; dodatki: apnenec (drobna do groba, zmerna); površina: trda; TS 8; vbodi, valovnica. Stavba 1, kv. 668/A2. Inv. št. 20743.

14. Skleda; del ustja z ostenjem; groba keramika; barva zunaj, znotraj in v prelomu: črna; dodatki: apnenec (drobna, zmerna); površina: trda; TS 8; vbodi, enolinijska valovnica. Stavba 1, kv. 619/B3, SE 67. Inv. št. 21174.

Tabla 82

1. Skleda; del ustja z ostenjem; groba keramika; barva zunaj: siva; barva znotraj in v prelomu: črna; dodatki: apnenec (drobna, zmerna), sljuda (zelo fina, zmerna); površina: trda; TS 4; dvolinijska valovnica, vrezji. Stavba 1, kv. 669/B4, SE 24. Inv. št. 21010.

2. Skleda; del ustja z ostenjem; groba keramika; barva zunaj: rjava; barva znotraj in v prelomu: črna; dodatki: apnenec (drobna, zmerna); površina: mehka, rahlo porozna; TS 9; metličenje, enolinijska valovnica. Stavba 1, kv. 815/D1, SE 14. Inv. št. 21995.

3. Skleda; 2 dela ustja z ostenjem in dnom; groba keramika; barva zunaj, znotraj in v prelomu: temno siva; dodatki: apnenec (drobna do groba, zmerna); površina: trda; TS 14; vbodi, žlebljenje. Stavba 1, kv. 669/C3, SE 29. Inv. št. 21005, 22167.

4. Skleda; del ustja z ostenjem; groba keramika; barva zunaj, znotraj in v prelomu: siva; dodatki: apnenec (drobna do groba, zmerna), sljuda (zelo fina, zmerna); površina: trda, porozna; TS 7; metličenje. Stavba 1, kv. 668/C1. Inv. št. 20777.

5. Skleda; del ustja z ostenjem; groba keramika; barva zunaj: svetlo rjava; barva znotraj: rjava; barva v prelomu: siva; dodatki: apnenec (drobna, zmerna); površina: mehka, rahlo porozna; TS 1. Stavba 1, kv. 816/D1, SE 09. Inv. št. 20094.

6. Skleda; 6 delov ustja in 6 ostenja; groba keramika; barva zunaj, znotraj in v prelomu: rjava; dodatki: apnenec (drobna do groba, obilna); površina: trda; TS 6; glavničenje. Stavba 1, kv. 666/A1, SE 50. Inv. št. 22190.

– Modrijan 2010, sl. 5: 4.

7. Skleda; del ustja z ostenjem in del dna z ostenjem; groba keramika; barva zunaj, znotraj in v prelomu: rjava; dodatki:

apnenec (drobna, zmerna); površina: trda; TS 6; žlebljenje. Stavba 1, kv. 669/A2, SE 30. Inv. št. 20971.

8. Skleda; del ustja z ostenjem; groba keramika; barva zunaj, znotraj in v prelomu: svetlo rjava; dodatki: apnenec (drobna, zmerna); površina: trda; TS 2; navzkrižno metličenje; Stavba 1, kv. 666/C1, SE 50. Inv. št. 20890.

– Modrijan 2010, sl. 5: 5.

9. Skleda; del ustja z ostenjem; groba keramika; barva zunaj, znotraj in v prelomu: rjava; dodatki: apnenec (drobna, zmerna); površina: trda; TS 6; navzkrižno metličenje. Stavba 1, kv. 717/A2, SE 24. Inv. št. 21383.

– Modrijan 2010, sl. 5: 6.

Tabla 83

1. Skleda; del ustja z ostenjem in del ostenja; groba keramika; barva zunaj in znotraj: siva; barva v prelomu: črna; dodatki: apnenec (drobna, zmerna), sljuda (zelo fina, zmerna); površina: trda; TS 4; večlinijska valovnica, žlebljenje. Stavba 1, kv. 669/A4. Inv. št. 20897.

2. Skleda; del ustja z ostenjem; groba keramika; barva zunaj, znotraj in v prelomu: oranžna; dodatki: apnenec (fina do groba, obilna); površina: trda; TS 2; metličenje. Stavba 1, kv. 669/C3. Inv. št. 21027.

3. Skleda; del ustja z ostenjem; groba keramika; barva zunaj in znotraj: oranžna; barva v prelomu: siva; dodatki: apnenec (drobna, zmerna); površina: trda; TS 1; metličenje. Stavba 1, kv. 769/C1, SE 04. Inv. št. 21978.

4. Skleda; del ustja z ostenjem; groba keramika; barva zunaj, znotraj in v prelomu: rjava; dodatki: apnenec (drobna, zmerna); površina: trda; TS 6; žlebljenje. Stavba 1, kv. 717/A4, SE 77. Inv. št. 20812.

5. Skleda; del ustja z ostenjem; groba keramika; barva zunaj, znotraj in v prelomu: rjava; dodatki: apnenec (drobna, redka); površina: mehka, močno porozna; TS 5; žlebljenje. Stavba 1, kv. 816/D1, SE 09. Inv. št. 20077.

6. Skleda; del ustja z ostenjem; groba keramika; barva zunaj, znotraj in v prelomu: svetlo rjava; dodatki: apnenec (drobna, zmerna); površina: trda; TS 2. Stavba 1, kv. 719/A4. Inv. št. 21426.

7. Skleda; del ustja z ostenjem; groba keramika; barva zunaj, znotraj in v prelomu: črna; dodatki: apnenec (drobna, obilna); površina: trda; TS 14; vbodi. Stavba 1, kv. 669/D1, SE 30. Inv. št. 21075.

8. Skleda; del ustja z ostenjem; groba keramika; barva zunaj, znotraj in v prelomu: rjava; dodatki: apnenec (drobna, zmerna); površina: trda; TS 6; vbodi. Stavba 1, kv. 768/C3 C4, SE 05. Inv. št. 21863.

9. Skleda; deli ustja in ostenja; groba keramika; barva zunaj, znotraj in v prelomu: rjava; dodatki: apnenec (drobna do groba, zmerna); površina: trda; TS 6; navzkrižno metličenje. Stavba 1, kv. 669/B3, SE 29a. Inv. št. 21705.

10. Skleda; 2 dela ustja z ostenjem; groba keramika; barva zunaj, znotraj in v prelomu: rjava; dodatki: apnenec (drobna, zmerna); površina: trda; TS 6; metličenje. Stavba 1, kv. 766/A4, SE 24. Inv. št. 20284.

11. Skleda; del ustja z ostenjem; groba keramika; barva zunaj in znotraj: rjava; barva v prelomu: oranžna; dodatki: apnenec (drobna, redka); površina: trda; TS 6; metličenje. Stavba 1, kv. 719. Inv. št. 20820.

Tabla 84

1. Skleda; del ustja in ostenja; groba keramika; barva zunaj, znotraj in v prelomu: rjava; dodatki: apnenec (drobna, zmerna); površina: trda; TS 6; navzkrižno metličenje. Stavba 1, kv. 766/A4, SE 24. Inv. št. 20828.

2. Skleda; del ustja z ostenjem; groba keramika; barva zunaj, znotraj in v prelomu: rjava; dodatki: apnenec (drobna, zmerna); oksidacijsko; površina: trda; TS 6; navzkrižno metličenje. Stavba 1, kv. 719/B1, SE 24. Inv. št. 22024.

3. Skleda; del ustja z ostenjem; groba keramika; barva zunaj, znotraj in v prelomu: rjava; dodatki: apnenec (fina, zmerna); površina: trda; TS6; metličenje. Stavba 1, kv. 669/C3, SE 29. Inv. št. 21007.

4. Skleda; del ustja z ostenjem; groba keramika; barva zunaj, znotraj in v prelomu: svetlo rjava; dodatki: apnenec (fina, zmerna); površina: trda; TS 2; navzkrižno metličenje. Stavba 1, kv. 669/A2, SE 29. Inv. št. 21447.

5. Skleda; del ustja z ostenjem; groba keramika; barva zunaj, znotraj in v prelomu: rjava; dodatki: apnenec (fina do drobna, zmerna); površina: trda; TS 6; navzkrižno metličenje. Stavba 1, kv. 669/A3, SE 24. Inv. št. 20877.

6. Skleda; del ustja z ostenjem; groba keramika; barva zunaj in znotraj: rjava; barva v prelomu: črna; dodatki: apnenec (fina, zmerna); površina: mehka; TS neopr. Stavba 1, kv. 717/D1, SE 06. Inv. št. 20569.

7. Skleda; del ustja z ostenjem; groba keramika; barva zunaj in v prelomu črna; barva znotraj: oranžna; dodatki: apnenec (drobna, zmerna); površina: trda; TS 14; večlinijska valovnica, metličenje. Stavba 1, kv. 719/B4, SE 04. Inv. št. 21506.

8. Skleda; del ustja z ostenjem; groba keramika; barva zunaj, znotraj in v prelomu: črna; dodatki: apnenec (fina, zmerna); površina: mehka, rahlo porozna; TS 8. Stavba 1, kv. 716/C1, SE 06. Inv. št. 21242.

9. Skleda; del ustja z ostenjem; groba keramika; barva zunaj, znotraj in v prelomu: siva; dodatki: apnenec (drobna, zmerna); površina: trda; TS 8; enolinijska valovnica, žlebljenje. Stavba 1, kv. 716/A4, SE 23. Inv. št. 21176.

10. Skleda; 2 dela ustja z ostenjem; groba keramika; barva zunaj, znotraj in v prelomu: črna; dodatki: apnenec (drobna, zmerna); površina: trda; TS 14; vtisi, večlinijska valovnica, enojna valovnica. Stavba 1, kv. 817/D2, SE 03. Inv. št. 20247.

– Ciglenečki 1994, sl. 3: 1.

11. Skleda; del ustja z ostenjem; groba keramika; barva zunaj, znotraj in v prelomu: rjava; dodatki: apnenec (drobna, zmerna); površina: mehka, rahlo porozna; TS 2. Stavba 1, 716/D1, SE 06. Inv. št. 20253

12. Skleda; del ustja z ostenjem; groba keramika; barva zunaj: rjava lisasta; barva znotraj in v prelomu: črna; dodatki: apnenec (drobna, obilna); površina: trda, rahlo porozna; TS 14; dvojna valovnica, večlinijska valovnica. Stavba 1, kv. 669/C1, SE 30. Inv. št. 21065.

13. Skleda; del ustja z ostenjem; groba keramika; barva zunaj, znotraj in v prelomu: siv; dodatki: apnenec (groba, zmerna), sljuda (zelo fina, zmerna); površina: trda; TS 7. Stavba 1, kv. 718/A3, SE 21. Inv. št. 20303.

Tabla 85

1. Skleda; del ustja z ostenjem; groba keramika; barva zunaj, znotraj in v prelomu: črna; dodatki: apnenec (drobna,

zmerna); površina: trda; TS 8. Stavba 1, kv. 716/C2, SE 23. Inv. št. 21235.

2. Skleda; del ustja z ostenjem; groba keramika; barva zunaj in znotraj: siva in rjava; barva v prelomu: siva; dodatki: apnenec (drobna, zmerna), sljuda (zelo fina, zmerna); površina: trda; TS 15. Stavba 1, kv. 716/B4, SE 23. Inv. št. 21218.

3. Skleda; del ustja z ostenjem; groba keramika; barva zunaj in v prelomu; svetlo rjava; barva znotraj: oranžna; dodatki: apnenec (fina, redka); površina: mehka, rahlo porozna; TS 1; enolinijska in dvolinijska valovnica, metličenje. Stavba 1, kv. 669/B2, SE 30. Inv. št. 20938.

– Modrijan 2010, sl. 2: 9.

4. Skleda; del ustja z ostenjem; groba keramika; barva zunaj: svetlo rjava; barva znotraj: rjava; barva v prelomu: črna; dodatki: apnenec (fina, obilna); površina: trda; TS 1; dve enolinijski valovnici. Stavba 1, kv. 816/D1. Inv. št. 20102.

5. Skleda; del ustja z ostenjem in dno; barva zunaj, znotraj in v prelomu: rjava in oranžna; dodatki: kremen (fina, zmerna), sljuda (zelo fina, zmerna); površina: zelo trda; TS neopr.; vrezi. Stavba 1, kv. 666/B2, SE 29. Inv. št. 21701.

6. Krožnik; del ustja z ostenjem in dnom; groba keramika; barva zunaj, znotraj in v prelomu: črna; dodatki: apnenec (fina, obilna); površina: mehka, močno porozna; TS 9; dve enolinijski valovnici, žlebljenje. Stavba 1, kv. 666/C3, SE 07. Inv. št. 20627, 20637, 21711.

– Ciglenečki 1994b, sl. 3.7; Modrijan 2010, sl. 5: 7.

Tabla 86

1. Pokrov; del ustja z ostenjem; groba keramika; barva zunaj, znotraj in v prelomu: črna; dodatki: apnenec (fina, obilna); površina: mehka, rahlo porozna; TS 9. Stavba 1, kv. 816/B1, SE 09. Inv. št. 20045.

2. Pokrov; del ustja z ostenjem; groba keramika; barva zunaj, znotraj in v prelomu: črna; dodatki: apnenec (fina, zmerna); površina: mehka, rahlo porozna; TS 9. Stavba 1, kv. 767/A2, SE 10. Inv. št. 20164.

3. Pokrov; del ustja z ostenjem; groba keramika; barva zunaj, znotraj in v prelomu: siva; dodatki: apnenec (fina, zmerna), sljuda (zelo fina, zmerna); površina: trda; TS 4; enolinijska valovnica. Stavba 1, kv. 719/A1, SE 08. Inv. št. 21413.

4. Pokrov; del ustja z ostenjem; groba keramika; barva zunaj, znotraj in v prelomu: črna; dodatki: apnenec (fina do drobna, obilna); površina: mehka, rahlo porozna; TS 8. Stavba 1, kv. 766/A4, SE 01. Inv. št. 21781.

5. Pokrov; del ustja z ostenjem in ročajem; groba keramika; barva zunaj, znotraj in v prelomu: siva; dodatki: apnenec (drobna, zmerna), sljuda (fina, zmerna); površina: trda; TS 8; vrezi. Stavba 1, kv. 666/B2,C2. Inv. št. 21011.

6. Pokrov; del ustja z ostenjem in ročajem; groba keramika; barva zunaj, znotraj in v prelomu: siva; dodatki: apnenec (drobna, zmerna), sljuda (fina, zmerna); površina: trda; TS 8; vrezi. Stavba 1, kv. 666/A3, SE 50. Inv. št. 21013.

7. Pokrov; del ustja z ostenjem; groba keramika; barva zunaj, znotraj in v prelomu: rjava; dodatki: apnenec (fina, zmerna); površina: trda; TS 6; metličenje, enolinijska valovnica, vrezi. Stavba 1, kv. 666/D3, SE 23. Inv. št. 20628.

8. Pokrov; del ustja z ostenjem; groba keramika; barva zunaj, znotraj in v prelomu: rjava; dodatki: apnenec (drobna, zmerna); površina: trda; TS 5; enolinijska valovnica, vrezi. Stavba 1, kv. 666/A2, SE 34. Inv. št. 20543.



9. Pokrov; del ustja z ostenjem; groba keramika; barva zunaj, znotraj in v prelomu: rjava; dodatki: apnenec (drobna, zmerna); površina: trda; TS 6; metličenje. Stavba 1, kv. 766. Inv. št. 20571.

10. Pokrov; del ustja z ostenjem; groba keramika; barva zunaj, znotraj in v prelomu: rjava; dodatki: apnenec (drobna, zmerna); površina: trda; TS 5. Stavba 1, kv. 669/B3, SE 23. Inv. št. 20931, 22025.

11. Pokrov; del ustja z ostenjem; groba keramika; barva zunaj, znotraj in v prelomu: rjava; dodatki: apnenec (fina do drobna, obilna); površina: trda, rahlo porozna; TS 6; metličenje, enolinijska valovnica. Stavba 1, kv. 666/B3, SE 23. Inv. št. 20605.

12. Pokrov; del ustja z ostenjem; groba keramika; barva zunaj, znotraj in v prelomu: svetlo rjava; dodatki: apnenec (drobna, redka); površina: trda; TS 2; metličenje. Stavba 1, kv. 766/A2, SE 23. Inv. št. 21752.

13. Pokrov; del ustja z ostenjem; groba keramika; barva zunaj, znotraj in v prelomu: rjava; dodatki: apnenec (drobna, redka); površina: trda; TS 6; enolinijska valovnica. Stavba 1, kv. 666/A1, A2, SE 34. Inv. št. 20891.

14. Pokrov; del ustja z ostenjem; groba keramika; barva zunaj, znotraj in v prelomu: siva; dodatki: apnenec (drobna, zmerna), sljuda (zelo fina, zmerna); površina: zelo trda; TS 4. Stavba 1, kv. 668/D3, SE 24. Inv. št. 20324.

15. Pokrov; del ustja z ostenjem; groba keramika; barva zunaj, znotraj in v prelomu: temno siva; dodatki: apnenec (fina, zmerna); površina: trda; TS 8; metličenje. Stavba 1, kv. 719/A2, SE 10. Inv. št. 20521.

16. Pokrov; del ustja z ostenjem; groba keramika; barva zunaj, znotraj in v prelomu: rjava; dodatki: apnenec (drobna, redka); površina: trda; TS 6; metličenje. Stavba 1, kv. 766/A2, SE 23. Inv. št. 21740.

17. Pokrov; del ustja z ostenjem; groba keramika; barva zunaj, znotraj in v prelomu: svetlo rjava; dodatki: apnenec (drobna, zmerna); površina: trda; TS 2. Stavba 1, kv. 668/D3, SE 24. Inv. št. 21443.

18. Pokrov; del ustja in ostenja; groba keramika; barva zunaj, znotraj in v prelomu: svetlo rjava; dodatki: apnenec (drobna do groba, obilna); površina: trda; TS 3. Stavba 1, kv. 666/B3, SE 56. Inv. št. 21355.

*Tabla 87*

1. Lonec; del ustja z ostenjem; groba keramika; barva zunaj, znotraj in v prelomu: črna; dodatki: apnenec (fina, zmerna), sljuda (zelo fina, zmerna); površina: trda; TS 11; metličenje, dvolinijska valovnica. Stavba 1, kv. 817/C3, SE 03. Inv. št. 22054.

2. Lonec; del ustja z ostenjem; groba keramika; barva zunaj, znotraj in v prelomu: črna; dodatki: apnenec (drobna, redka); površina: trda; TS 8. Stavba 1, kv. 817/A2, SE 10. Inv. št. 20033.

3. Lonec; del ustja z ostenjem; groba keramika; barva zunaj, znotraj in v prelomu: temno siva; dodatki: apnenec (drobna, zmerna), sljuda (zelo fina, redka); površina: trda, rahlo porozna; TS 13; vrezi. Stavba 1, kv. 767/D4, SE 22. Inv. št. 20220.

– Modrijan 2010, sl. 2: 7.

4. Lonec; del ustja z ostenjem; groba keramika; barva zunaj, znotraj in v prelomu: črna; dodatki: apnenec (groba do zelo groba, zmerna); površina: trda; TS 12. Stavba 1, kv. 817. Inv. št. 22041.

5. Lonec; del ustja z ostenjem; groba keramika; barva zunaj, znotraj in v prelomu: temno rjava; dodatki: apnenec (drobna do fina, zmerna); površina: trda, rahlo porozna; metličenje. Stavba 1, kv. 717/A4, SE 10. Inv. št. 20330, 20375.

6. Lonec; del ustja z ostenjem; groba keramika; barva zunaj in znotraj: rjava in siva; barva v prelomu: siva; dodatki: apnenec (drobna, zmerna), sljuda (zelo fina, zmerna); površina: trda; TS 15; enolinijska valovnica, metličenje. Stavba 1, kv. 719/B2, SE 32. Inv. št. 21487.

– Modrijan 2010, sl. 2: 8.

7. Lonec; del ustja z ostenjem; groba keramika; barva zunaj, znotraj in v prelomu: črna; dodatki: apnenec (fina, zmerna), sljuda (zelo fina, zmerna); površina: trda; TS 13; dve enolinijski valovnici. Stavba 1, kv. 769/A1, SE 03. Inv. št. 21891.

8. Lonec; del ustja z ostenjem; groba keramika; barva zunaj, znotraj in v prelomu: črna; dodatki: apnenec (fina, zmerna), sljuda (zelo fina, redka); površina: trda, rahlo porozna; dve prepleteni enolinijski valovnici, vrezi. Stavba 1, kv. 716/B1, SE 06. Inv. št. 21149.

9. Lonec; del ustja z ostenjem; groba keramika; barva zunaj, znotraj in v prelomu: siva; dodatki: apnenec (drobna, obilna); površina: trda; TS 8. Stavba 1, kv. 666/B4, SE 50. Inv. št. 22159.

10. Lonec; del ustja z ostenjem; groba keramika; barva zunaj: črna; barva znotraj: oranžna in črna; barva v prelomu: oranžna; dodatki: apnenec (drobna, redka); površina: mehka, rahlo porozna; TS 10. Stavba 1, kv. 666/D3, SE 23. Inv. št. 20673.

11. Lonec; del ustja z ostenjem; groba keramika; barva zunaj: svetlo rjava in črna; barva znotraj: črna; barva v prelomu: rjava; dodatki: apnenec (drobna, zmerna), sljuda (zelo fina, zmerna); površina: trda; TS 15. Stavba 1, kv. 669/D1, SE 30. Inv. št. 21076.

*Tabla 88*

1. Lonec; del ustja z ostenjem; groba keramika; barva zunaj, znotraj in v prelomu: črna; dodatki: apnenec (drobna, zmerna), sljuda (fina, zmerna); površina: trda; TS 13; dve enolinijski valovnici, vrez. Stavba 1, kv. 766/A4, SE 24. Inv. št. 21774, 21775, 21776.

2. Lonec; del ustja z ostenjem; groba keramika; barva zunaj in znotraj: oranžna; barva v prelomu: svetlo rjava; dodatki: apnenec (drobna do groba, zmerna); površina: mehka; TS 1. Stavba 1, kv. 769/719, SE 03. Inv. št. 21991.

3. Lonec; del ustja z ostenjem; groba keramika; barva zunaj, znotraj in v prelomu: črna; dodatki: apnenec (fina, zmerna); površina: trda; TS 8; metličenje, dve enolinijski valovnici. Stavba 1, kv. 719/B1, SE 01. Inv. št. 21446.

4. Lonec; del ustja z ostenjem; groba keramika; barva zunaj, znotraj in v prelomu: črna; dodatki: apnenec (drobna, redka), sljuda (zelo fina, redka); površina: trda; TS 13; enolinijska valovnica. Stavba 1, kv. 668/D2, SE 28. Inv. št. 20815.

5. Lonec; del ustja z ostenjem; groba keramika; barva zunaj, znotraj in v prelomu: črna; dodatki: apnenec (drobna, zmerna); površina: trda; TS 8. Stavba 1, kv. 766/B2, SE 23. Inv. št. 21793.

6. Lonec; del ustja z ostenjem; groba keramika; barva zunaj, znotraj in v prelomu: črna in rjava; dodatki: apnenec (fina, redka); površina: mehka, rahlo porozna; TS 10. Stavba 1, kv. 666/B2, SE 23. Inv. št. 20624.

7. Lonec; del ustja z ostenjem; groba keramika; barva zunaj, znotraj in v prelomu: črna; dodatki: apnenec (fina do groba,

zmerna); površina: trda, rahlo porozna; TS 12. Stavba 1, kv. 766/A1, SE 23. Inv. št. 21716.

8. Lonec; del ustja in ostenja; groba keramika; barva zunaj, znotraj in v prelomu: črna; dodatki: apnenec (fina, zmerna); mehka, rahlo porozna; TS 9. Stavba 1, kv. 666/A2, SE 34. Inv. št. 21294.

9. Lonec; del ustja z ostenjem; groba keramika; barva zunaj, znotraj in v prelomu siva; dodatki: apnenec (drobna, redka); površina: trda; TS 8; poševno metličenje. Stavba 1, kv. 669/B4, SE 26. Inv. št. 21038.

10. Lonec; del ustja z ostenjem; groba keramika; barva zunaj, znotraj in v prelomu siva; dodatki: apnenec (drobna, redka); površina: trda; TS 8; poševno metličenje. Stavba 1, kv. 768, SE 03. Inv. št. 21877.

11. Lonec; del ustja z ostenjem; groba keramika; barva zunaj: rjava in oranžna; barva znotraj: oranžna; barva v prelomu: oranžno-sivo-oranžna; dodatki: apnenec (drobna, redka); površina: trda; TS 8. Stavba 1, kv. 717/A2, SE 23a. Inv. št. 20539.

12. Lonec; del ustja z ostenjem; groba keramika; barva zunaj, znotraj in v prelomu: črna; dodatki: apnenec (drobna, zmerna); površina: trda; TS 8. Stavba 1, kv. 816/D1. Inv. št. 20588.

13. Lonec; del ustja z ostenjem; groba keramika; barva zunaj: črna; barva znotraj: rjava lisasta; barva v prelomu: rjava; dodatki: apnenec (fina, redka); površina: mehka, močno porozna; TS 10. Stavba 1, kv. 818/A3, SE 03. Inv. št. 22115.

14. Lonec; del ustja z ostenjem; groba keramika; barva zunaj, znotraj in v prelomu: črna; dodatki: apnenec (drobna, zmerna); površina: trda; TS 8; vrezi. Stavba 1, kv. 767, SE 39. Inv. št. 20239.

8. Lonec; groba keramika; barva zunaj, znotraj in v prelomu: črna; dodatki: apnenec (fina, zmerna); površina: trda; TS 8. Stavba 1, kv. 717/B1, SE 01. Inv. št. 20557.

9. Lonec; del ustja z ostenjem; groba keramika; barva zunaj, znotraj in v prelomu: črna; dodatki: apnenec (drobna, zmerna); površina: trda; TS 8. Stavba 1, kv. 669/A3, SE 29a. Inv. št. 22158.

10. Lonec; dva dela ostenja; groba keramika; barva zunaj, znotraj in v prelomu: črna; dodatki: apnenec (zelo fina, redka); površina: trda, rahlo porozna; TS 13. Stavba 1, kv. 918/B1, SE 62. Inv. št. 21140.

11. Lonec; del ustja z ostenjem; groba keramika; barva zunaj in znotraj: rjava; barva v prelomu: siva; dodatki: apnenec (drobna, obilna), sljuda (zelo fina, zmerna); površina: mehka, porozna; TS 5. Stavba 1, kv. 718/A2, SE 10. Inv. št. 20365.

12. Lonec; del ustja z ostenjem; groba keramika; barva zunaj, znotraj in v prelomu: temno rjava; dodatki: apnenec (zelo fina, zmerna); površina: mehka, rahlo porozna; TS 9. Stavba 1, kv. 767/B1, SE 10. Inv. št. 20184.

13. Lonec; del ustja z ostenjem; groba keramika; barva zunaj, znotraj in v prelomu: črna; dodatki: apnenec (groba, zmerna); površina: trda; TS 8; enolinijska valovnica, vrezi. Stavba 1, kv. 669/B1, SE 24. Inv. št. 22046.

14. Lonec; del ustja z ostenjem; groba keramika; barva zunaj, znotraj in v prelomu: rjava; dodatki: apnenec (fina, zmerna), sljuda (zelo fina, redka); površina: trda; TS. Stavba 1, kv. 669/D2, SE 30. Inv. št. 21089.

15. Lonec; del ustja z ostenjem; groba keramika; barva zunaj, znotraj in v prelomu: oranžna; dodatki: apnenec (drobna, zmerna), sljuda (zelo fina, redka); površina: trda; TS 2. Stavba 1, kv. 769/A3, SE 04. Inv. št. 21924.

Tabla 89

1. Lonec; 2 dela ustja z ostenjem in del ostenja; groba keramika; barva zunaj, znotraj in v prelomu: črna; dodatki: apnenec (fina, zmerna); površina: trda; TS 8; metličenje, večlinijska valovnica. Stavba 1, kv. 717/A1, SE 68. Inv. št. 21379, 21380.

2. Lonec; del ustja z ostenjem; groba keramika; barva zunaj, znotraj in v prelomu: črna; dodatki: apnenec (drobna, zmerna); površina: trda; TS 8; metličenje. Stavba 1, kv. 669/B1, SE 29. Inv. št. 22063.

3. Lonec; del ustja z ostenjem; groba keramika; barva zunaj, znotraj in v prelomu: črna; dodatki: apnenec (zelo fina, redka); površina: mehka, rahlo porozna; TS 9; vrezi. Stavba 1, kv. 669/B2, SE 24. Inv. št. 20967.

4. Lonec; del ustja z ostenjem; groba keramika; barva zunaj, znotraj in v prelomu: črna; dodatki: apnenec (drobna do groba, zmerna); površina: trda; TS neopred. Stavba 1, kv. 768, SE 03. Inv. št. 21874.

5. Lonec; del ustja z ostenjem; groba keramika; barva zunaj, znotraj in v prelomu: črna; dodatki: apnenec (drobna do groba, zmerna); površina: trda; TS 8; žlebljenje. Stavba 1, kv. 666/B2, C2. Inv. št. 20983.

6. Lonec; del ustja z ostenjem; groba keramika; barva zunaj, znotraj in v prelomu: črna; dodatki: apnenec (fina do drobna, obilna); površina: trda; TS 8; večlinijska valovnica, metličenje. Stavba 1, kv. 669/B3, SE 24. Inv. št. 20965.

7. Lonec; del ustja z ostenjem; groba keramika; barva zunaj: rjava; barva znotraj: črna in oranžna; barva v prelomu: oranžna; dodatki: apnenec (drobna do groba, zmerna); površina: trda; TS 3. Stavba 1, kv. 666/A2, SE 34. Inv. št. 21691.

Tabla 90

1. Lonec; del ustja z ostenjem; groba keramika; barva zunaj, znotraj in v prelomu: rjava; dodatki: apnenec (drobna, zmerna); površina: trda; TS 5; dvolinijska valovnica, metličenje. Stavba 1, kv. 666/B4, SE 50. Inv. št. 21069.

– Modrijan 2010, sl. 4: 1.

2. Lonec; del ustja z ostenjem; groba keramika; barva zunaj, znotraj in v prelomu: svetlo rjava; dodatki: apnenec (drobna, zmerna); površina: trda; TS 1; metličenje. Stavba 1, kv. 669/C2, SE 30. Inv. št. 20987.

3. Lonec; del ustja z ostenjem; groba keramika; barva zunaj, znotraj in v prelomu: črna; dodatki: apnenec (drobna, obilna); površina: trda; TS 8; večlinijska valovnica. Stavba 1, kv. 769/B1, SE 04. Inv. št. 21929.

4. Lonec; del ustja z ostenjem; groba keramika; barva zunaj: rjava; barva znotraj in v prelomu: oranžna; dodatki: apnenec (drobna do groba, obilna); površina: mehka, rahlo porozna; TS 3. Stavba 1, kv. 669/C1, SE 30. Inv. št. 21062, 21063.

5. Lonec; del ustja z ostenjem; groba keramika; barva zunaj, znotraj in v prelomu: svetlo rjava; dodatki: apnenec (drobna, zmerna); površina: trda; TS 2; metličenje. Stavba 1, kv. 716/C1, SE 24. Inv. št. 21224.

6. Lonec; del ustja z ostenjem; groba keramika; barva zunaj, znotraj in v prelomu: svetlo rjava; dodatki: apnenec (drobna, zmerna); površina: trda, rahlo porozna; TS 1. Stavba 1, kv. 669/D2, SE 30. Inv. št. 21088.

7. Lonec; del ustja z ostenjem; groba keramika; barva zunaj, znotraj in v prelomu: siva; dodatki: apnenec (drobna, zmerna);

površina: trda, rahlo porozna; TS 6. Stavba 1, SE 666/A3, SE 50. Inv. št. 22176

8. Lonec; del ustja in ostenja; groba keramika; barva zunaj in znotraj: oranžna; barva v prelomu: črna; dodatki: apnenec (drobna, zmerna), sljuda (fina s posameznimi grobimi delci, obilna); površina: mehka, rahlo porozna; TS 1. Stavba 1, kv. 669/D2, SE 30. Inv. št. 21093.

#### Tabla 91

1. Lonec; del ustja z ostenjem; groba keramika; barva zunaj, znotraj in v prelomu: svetlo rjava; dodatki: apnenec (drobna, zmerna), sljuda (fina, zmerna); površina: trda, rahlo porozna; TS 2. Stavba 1, kv. 669/B2, SE 30. Inv. št. 20941.

2. Lonec; del ustja z ostenjem; groba keramika; barva zunaj, znotraj in v prelomu: svetlo rjava; dodatki: apnenec (drobna, zmerna); površina: trda; TS 2. Stavba 1, kv. 669/D2, SE 30. Inv. št. 21091.

3. Lonec; del ustja z ostenjem; groba keramika; barva zunaj, znotraj in v prelomu: svetlo rjava; dodatki: apnenec (drobna, redka); površina: mehka, rahlo porozna; TS 2. Stavba 1, kv. 716/A3. Inv. št. 20884.

4. Lonec; del ustja z ostenjem; groba keramika; barva zunaj, znotraj in v prelomu: svetlo rjava; dodatki: apnenec (drobna, zmerna); površina: mehka; TS 2. Stavba 1, kv. 669/A3, SE 29a. Inv. št. 21028.

5. Lonec; del ustja z ostenjem; groba keramika; barva zunaj in znotraj: črna in oranžna; barva v prelomu: črna; dodatki: apnenec (drobna, redka); površina: trda; TS neopr. Stavba 1, kv. 717/A2, SE 24. Inv. št. 21384.

6. Lonec; del ustja z ostenjem; groba keramika; barva zunaj, znotraj in v prelomu: siva; dodatki: apnenec (drobna do groba, redka); površina: trda; TS 8. Stavba 1, kv. 668/C1. Inv. št. 20779.

7. Lonec; del ustja z ostenjem; groba keramika; barva zunaj, znotraj in v prelomu: svetlo rjava; dodatki: apnenec (drobna, zmerna); površina: trda; TS 2. Stavba 1, kv. 716/C3, SE 24. Inv. št. 20833.

8. Lonec; 2 dela ustja z ostenjem, groba keramika; zunaj, znotraj in v prelomu: črna; dodatki: apnenec (drobna do groba, obilna); površina: trda; TS 8. Stavba 1, kv. 666/A1, SE 50. Inv. št. 22189.

– Modrijan 2010, sl. 4: 9.

9. Lonec; del ustja z ostenjem; groba keramika; barva zunaj, znotraj in v prelomu: črna; dodatki: apnenec (fina, zmerna), zdobljena keramika (fina, redka); površina: mehka, močno porozna; TS 9. Stavba 1, kv. 867/D2. Inv. št. 21429.

10. Lonec; del ustja z ostenjem; groba keramika; barva zunaj, znotraj in v prelomu: svetlo rjava; dodatki: apnenec (drobna, zmerna); površina: mehka; TS 2. Stavba 1, kv. 666/C1. Inv. št. 20762.

11. Lonec; del ustja z ostenjem; groba keramika; barva zunaj in znotraj: rjava; barva v prelomu: siva; dodatki: apnenec (drobna, redka); površina: mehka, rahlo porozna; TS 10. Stavba 1, kv. 719/D1, SE 01. Inv. št. 21633.

12. Lonec; del ustja z ostenjem; groba keramika; barva zunaj, znotraj in v prelomu: temno siva; dodatki: apnenec (fina, zmerna), sljuda (zelo fina, zmerna); površina: zelo trda; TS 4. Stavba 1, kv. 666/A3, B3, SE 50. Inv. št. 20982.

13. Lonec; del ustja z ostenjem; groba keramika; barva zunaj, znotraj in v prelomu: črna; dodatki: apnenec (drobna

do groba, zmerna); površina: trda; TS 12. Stavba 1, kv. 666/C2, SE 24. Inv. št. 20621.

14. Lonec; del ustja z ostenjem; groba keramika; barva zunaj: svetlo rjava; barva znotraj: temno rjava; barva v prelomu: siva; dodatki: apnenec (drobna do groba, zmerna); površina: trda; TS 3. Stavba 1, kv. 669/A4, SE 24. Inv. št. 20592.

15. Lonec; del ustja z ostenjem; groba keramika; barva zunaj: svetlo siva; barva znotraj in v prelomu: črna; dodatki: apnenec (drobna do groba, redka); površina: trda; TS 8; metličenje, vrezi. Stavba 1, kv. 817/C3, SE 03. Inv. št. 22053.

16. Lonec; del ustja z ostenjem; groba keramika; barva zunaj: rjava; barva znotraj: oranžna; barva v prelomu: črna; dodatki: apnenec (drobna, zmerna); površina: trda; TS neopr. Stavba 1, kv. 819/D2. Inv. št. 20117

17. Lonec; del ustja z ostenjem; groba keramika; barva zunaj, znotraj in v prelomu: temno siva; dodatki: apnenec (fina, zmerna); površina: trda; TS 8; žlebljenje. Stavba 1, kv. 666/A2, SE 29. Inv. št. 20978.

18. Lonec; del ustja z ostenjem; groba keramika; barva zunaj, znotraj in v prelomu: siva; dodatki: apnenec (drobna do groba, zmerna), sljuda (zelo fina, zmerna); površina: zelo trda; TS 7; vrezi. Stavba 1, kv. 766/A2, SE 24. Inv. št. 21730.

#### Tabla 92

1. Lonec; del ustja z ostenjem; groba keramika; barva zunaj: črna; barva znotraj: svetlo in temno rjava; barva v prelomu: črna; dodatki: apnenec (drobna, zmerna), sljuda (zelo fina, zmerna); površina: mehka, porozna; TS 5. Stavba 1, kv. 815/D3, SE 14. Inv. št. 22012.

2. Lonec; del ustja z ostenjem; groba keramika; barva zunaj, znotraj in v prelomu: rjava; dodatki: apnenec (drobna, zmerna); površina: trda; TS 6. Stavba 1, kv. 669/B4, SE 24. Inv. št. 21049.

3. Lonec; del ustja z ostenjem; groba keramika; barva zunaj, znotraj in v prelomu: črna; dodatki: apnenec (drobna, zmerna); površina: trda; TS 8. Stavba 1, kv. 666/D2, SE 23. Inv. št. 20660, 20662, 20674.

4. Lonec; del ustja z ostenjem; groba keramika; barva zunaj, znotraj in v prelomu: črna; dodatki: apnenec (drobna, zmerna); sljuda (zelo fina, zmerna); površina: trda, močno porozna; TS 13. Stavba 1, kv. 666/C1, SE 29. Inv. št. 20534.

5. Lonec; del ustja z ostenjem; groba keramika; barva zunaj: siva; barva znotraj in v prelomu: rjava; dodatki: apnenec (drobna, zmerna), sljuda (zelo fina, zmerna); površina: mehka; TS neopr. Stavba 1, kv. 666/A2, SE 34. Inv. št. 20549.

6. Lonec; del ustja z ostenjem; groba keramika; barva zunaj in znotraj: črna; barva v prelomu: oranžna; dodatki: apnenec (drobna, zmerna); površina: trda; TS neopr. Stavba 1, kv. 766/D1, SE 22, 08. Inv. št. 20151.

7. Lonec; del ustja z ostenjem; groba keramika; barva zunaj in v prelomu: črna; barva znotraj: oranžna; dodatki: apnenec (fina do drobna, zmerna); površina: trda; TS neopr. Stavba 1, kv. 719/D2, SE 26. Inv. št. 21645.

8. Lonec; del ustja z ostenjem; groba keramika; barva zunaj, znotraj in v prelomu: črna; dodatki: apnenec (fina, obilna); površina: mehka, rahlo porozna; TS 8. Stavba 1, kv. 666/D1, SE 29. Inv. št. 21133.

9. Lonec; del ustja z ostenjem; groba keramika; barva zunaj, znotraj in v prelomu: temno rjava; dodatki: apnenec (fina do

groba, redka); površina: mehka, rahlo porozna; TS 12. Stavba 1, kv. 667/B2, SE 06. Inv. št. 20727.

10. Lonec; del ustja z ostenjem; groba keramika; barva zunaj, znotraj in v prelomu: rjava in črna; dodatki: apnenec (fina, zmerna); površina: mehka, rahlo porozna; TS 10. Stavba 1, kv. 816/D3, SE 09. Inv. št. 20124.

11. Lonec; 2 dela ustja z ostenjem; groba keramika; barva zunaj, znotraj in v prelomu: siva; dodatki: apnenec (fina, obilna); površina: trda; TS 8. Stavba 1, kv. 719/B1, SE 07. Inv. št. 21430.

12. Lonec; del ustja z ostenjem; groba keramika; barva zunaj, znotraj in v prelomu: svetlo rjava; apnenec; drobna, zmerna; površina: trda; TS 2; metličenje. Stavba 1, kv. 716/D3, SE 24. Inv. št. 21326.

13. Lonec; del ustja z ostenjem; groba keramika; barva zunaj, znotraj in v prelomu: siva; dodatki: apnenec (fina, zmerna), sljuda (zelo fina, redka); površina: trda; TS 13. Stavba 1, kv. 666/B3, SE 23. Inv. št. 20606.

14. Lonec; del ustja in ostenja; groba keramika; barva zunaj znotraj: rjava; barva v prelomu: siva; dodatki: apnenec (drobna do groba, zmerna), sljuda (zelo fina, zmerna); površina: trda; TS 15; metličenje. Stavba 1, kv. 716, SE 23. Inv. št. 21815.

#### Tabla 93

1. Lonec; del ustja z ostenjem; groba keramika; barva zunaj, znotraj in v prelomu: svetlo rjava; dodatki: apnenec (drobna, zmerna), sljuda (fina, zmerna); površina: trda; TS 2; enolinijska valovnica. Stavba 1, kv. 766/C1, SE 23. Inv. št. 21816.

2. Lonec; del ustja z ostenjem; groba keramika; barva zunaj, znotraj in v prelomu: svetlo rjava; apnenec; drobna, zmerna; površina: trda; TS 2. Stavba 1, kv. 717/D3, SE 08. Inv. št. 20426.

3. Lonec; del ustja z ostenjem; groba keramika; barva zunaj: svetlo in temno rjava; barva znotraj: temno rjava; barva v prelomu: črna; dodatki: apnenec (fina, zmerna); površina: mehka, rahlo porozna; TS 10. Stavba 1, kv. 718/A3, SE 11. Inv. št. 20378.

4. Lonec; del ustja z ostenjem; groba keramika; barva zunaj, znotraj in v prelomu: rjava; dodatki: apnenec (drobna, zmerna); površina: trda; TS 2. Stavba 1, SE 08. Inv. št. 20831.

5. Lonec; del ustja z ostenjem; groba keramika; barva zunaj, znotraj in v prelomu: rjava in črna; dodatki: apnenec (drobna, redka); površina: trda; TS 10. Stavba 1, kv. 668/D2, SE 28. Inv. št. 21083.

6. Lonec; del ustja z ostenjem; groba keramika; barva zunaj, znotraj in v prelomu: črna; dodatki: apnenec (drobna do groba, zmerna); površina: trda, rahlo porozna; TS 8. Stavba 1, kv. 719/C3, SE 04. Inv. št. 20331.

7. Lonec; del ustja z ostenjem; groba keramika; barva zunaj, znotraj in v prelomu: črna; dodatki: apnenec (fina, obilna); površina: trda; TS 8; tri enolinijske valovnice, vrez. Stavba 1, kv. 669/B1, SE 24. Inv. št. 20974.

8. Lonec; del ustja z ostenjem; groba keramika; barva zunaj in znotraj: rjava; barva v prelomu: siva; dodatki: apnenec (drobna, zmerna); površina: trda, rahlo porozna; TS 2. Stavba 1, kv. 669/A1, SE 23. Inv. št. 20870.

– Modrijan 2010, sl. 4: 5.

9. Lonec; del ustja z ostenjem; groba keramika; barva zunaj, znotraj in v prelomu: rjava; dodatki: apnenec (drobna, zmerna); površina: trda; TS 2. Stavba 1, SE 08. Inv. št. 22038.

10. Lonec; del ustja z ostenjem; groba keramika; barva zunaj, znotraj in v prelomu: črna; dodatki: apnenec (fina,

zmerna), sljuda: (zelo fina, zmerna); površina: trda; TS 4. Stavba 1, SE 10. Inv. št. 21009.

– Modrijan 2010, sl. 4: 7.

11. Lonec; del ustja z ostenjem; groba keramika; barva zunaj; temno siva; barva znotraj: rjava; barva v prelomu: siva; dodatki: apnenec (fina, zmerna), sljuda (zelo fina, zmerna); površina: trda; TS neopr. Stavba 1, kv. 716/D2. Inv. št. 21157.

#### Tabla 94

1. Lonec; del ustja z ostenjem in del ostenja; groba keramika; barva zunaj, znotraj in v prelomu: črna; dodatki: apnenec (fina, zmerna); površina: mehka, rahlo porozna; TS 8; metličenje. Stavba 1, kv. 768, SE 03. Inv. št. 21875, 21876.

2. Lonec; del ustja z ostenjem; groba keramika; barva zunaj, znotraj in v prelomu: svetlo rjava; apnenec; drobna, zmerna; površina: trda; TS 2. Stavba 1, kv. 716/D3, SE 24. Inv. št. 21327.

3. Lonec; del ustja z ostenjem; groba keramika; barva zunaj: svetlo rjava in črna; barva znotraj in v prelomu: črna; dodatki: apnenec (drobna, zmerna), sljuda (zelo fina, zmerna); površina: trda; TS 4. Stavba 1, kv. 769/A1, SE 03. Inv. št. 21884.

4. Lonec; del ustja z ostenjem; groba keramika; barva zunaj, znotraj in v prelomu: temno siva; dodatki: apnenec (drobna do fina, zmerna); površina: trda; TS 8. Stavba 1, kv. 768, SE 03. Inv. št. 21873.

5. Lonec; del ustja z ostenjem; groba keramika; barva zunaj, znotraj in v prelomu: črna; dodatki: apnenec (drobna, redka); površina: trda; TS 8. Stavba 1, kv. 668/C1, SE 26. Inv. št. 21922.

6. Lonec; del ustja z ostenjem; groba keramika; barva zunaj in znotraj: svetlo rjava; barva v prelomu: črna; dodatki: apnenec (drobna, zmerna); površina: trda; TS 1. Stavba 1, kv. 668/B1, SE 26. Inv. št. 20750.

7. Lonec; del ustja z ostenjem; groba keramika; barva zunaj, znotraj in v prelomu: temno siva; dodatki: apnenec (fina, zmerna); površina: trda; TS 8; žlebljenje. Stavba 1, kv. 719/B1. Inv. št. 21462.

8. Lonec; del ustja z ostenjem; groba keramika; barva zunaj, znotraj in v prelomu: svetlo rjava; apnenec; drobna, zmerna; površina: trda; TS 2; žlebljenje. Stavba 1, kv. 719/D2, SE 27. Inv. št. 20560.

9. Lonec; del ustja z ostenjem; groba keramika; barva zunaj, znotraj in v prelomu: siva; dodatki: apnenec (fina, zmerna); površina: trda; TS 8. Stavba 1, kv. 667/A2, SE 23. Inv. št. 20693.

– Modrijan 2010, sl. 4: 4.

10. Lonec; del ustja z ostenjem; groba keramika; barva zunaj in znotraj: svetlo rjava; barva v prelomu: črna; dodatki: apnenec (fina, zmerna); površina: trda; TS 1. Stavba 1, kv. 716/A4, SE 23. Inv. št. 21173.

11. Lonec; del ustja z ostenjem; groba keramika; barva zunaj, znotraj in v prelomu: rjava; dodatki: apnenec (drobna, zmerna); površina: trda; TS 6; žlebljenje. Stavba 1, kv. 717/B3, C2. Inv. št. 22163.

– Modrijan 2010, sl. 4: 6

12. Lonec; del ustja z ostenjem; groba keramika; barva zunaj in znotraj: svetlo rjava; barva v prelomu: oranžna; dodatki: apnenec (fina, zmerna); površina: trda, rahlo porozna; TS 2. Stavba 1, kv. 716/A4, SE 24. Inv. št. 21649.

13. Lonec; del ustja z ostenjem; groba keramika; barva zunaj, znotraj in v prelomu: rjava; dodatki: apnenec (drobna, zmerna); površina: trda; TS 6. Stavba 1, kv. 669/B3, SE 29a. Inv. št. 21029.

14. Lonec; del ustja z ostenjem; groba keramika; barva zunaj, znotraj in v prelomu: črna; dodatki: apnenec (fina, zmerna); površina: trda; TS 8. Stavba 1, kv. 666/A2, SE 56. Inv. št. 21360.

15. Lonec; del ustja z ostenjem; groba keramika; barva zunaj, znotraj in v prelomu: svetlo rjava; dodatki: apnenec (drobna, zmerna); površina: trda; TS 2. Stavba 1, kv. 666/B2, C2. Inv. št. 21353.

16. Lonec; del ustja z ostenjem; groba keramika; barva zunaj, znotraj in v prelomu: črna; dodatki: apnenec (fina, redka); površina: trda; TS 8. Stavba 1, kv. 716/C3, SE 24. Inv. št. 21328.

#### Tabla 95

1. Lonec; del ustja z ostenjem; groba keramika; barva zunaj in znotraj: svetlo rjava; barva v prelomu: črna; dodatki: apnenec (drobna, zmerna); površina: trda; TS 1; metličenje. Stavba 1, kv. 669/A3, A4. Inv. št. 21467.

2. Lonec; del ustja z ostenjem; groba keramika; barva zunaj, znotraj in v prelomu: črna; dodatki: apnenec (zelo fina do groba, zmerna); površina: trda, rahlo porozna; TS 12. Stavba 1, kv. 767, SE 30. Inv. št. 20230, 20241.

3. Lonec; del ustja z ostenjem; groba keramika; barva zunaj in znotraj: svetlo rjava; barva v prelomu: črna; dodatki: apnenec (drobna, obilna); površina: trda; TS neopr. Stavba 1, kv. 669/B2, SE 30. Inv. št. 20940.

4. Lonec; del ustja z ostenjem; groba keramika; barva zunaj, znotraj in v prelomu: črna; dodatki: apnenec (fina, zmerna); površina: trda; TS 8. Stavba 1, kv. 669/C2, SE 30. Inv. št. 20989.

5. Lonec; del ustja z ostenjem; groba keramika; barva zunaj in znotraj: svetlo rjava; barva v prelomu: temno siva; dodatki: apnenec (fina do drobna, zmerna), sljuda (zelo fina, redka); površina: mehka, rahlo porozna; TS 5. Stavba 1, kv. 666/C1, SE 50. Inv. št. 20545.

6. Lonec; del ustja z ostenjem; groba keramika; barva zunaj: rjava; barva znotraj in v prelomu: siva; dodatki: apnenec (fina, zmerna); površina: trda; TS 10; metličenje. Stavba 1, kv. 669/A3, SE 64. Inv. št. 21372.

7. Lonec; del ustja z ostenjem; groba keramika; barva zunaj, znotraj in v prelomu: rjava; dodatki: apnenec (drobna, zmerna); površina: trda; TS 2. Stavba 1, kv. 669/A3, SE 29a. Inv. št. 20583

8. Lonec; del ustja z ostenjem; groba keramika; barva zunaj in znotraj: svetlo rjava; barva v prelomu: temno siva; dodatki: apnenec (fina do drobna, zmerna), sljuda (zelo fina, redka); površina: mehka, rahlo porozna; TS 5; vrezji. Stavba 1, kv. 767/A3, SE 10. Inv. št. 20173, 20181.

– Modrijan 2010, sl. 6: 3; 2011, sl. 5: 3.

9. Lonec; del ustja z ostenjem; groba keramika; barva zunaj in znotraj: svetlo rjava; barva v prelomu: temno siva; dodatki: apnenec (fina, zmerna), sljuda (zelo fina, zmerna); površina: mehka; TS 5. Stavba 1, kv. 767/A1, SE 10. Inv. št. 20195.

10. Lonec; 3 deli ustja z ostenjem; groba keramika; barva zunaj, znotraj in v prelomu: črna; dodatki: apnenec (drobna do groba, zmerna), sljuda (zelo fina, redka); površina: trda; TS 5. Stavba 1, kv. 767/B3, SE 10. Inv. št. 20194, 20196, 20208.

11. Lonec; del ustja z ostenjem; groba keramika; barva zunaj, znotraj in v prelomu: črna; dodatki: apnenec (drobna, zmerna); površina: trda; TS 8; žlebljenje. Stavba 1, kv. 716/D1, SE 23. Inv. št. 21305.

#### Tabla 96

1. Lonec; del ustja in ostenja; groba keramika; barva zunaj, znotraj in v prelomu: črna; dodatki: apnenec (fina, zmerna); površina: trda; TS 8. Stavba 1, kv. 717/B2, SE 08. Inv. št. 20563.

2. Lonec; del ustja z ostenjem; groba keramika; barva zunaj in znotraj: rjava; barva v prelomu: črna; dodatki: apnenec (fina, zmerna), zdrobljena keramika (fina, redka), sljuda (zelo fina, zmerna); površina: mehka, rahlo porozna; TS 5. Stavba 1, kv. 717/C3, SE 10. Inv. št. 20287.

3. Lonec; del ustja z ostenjem; groba keramika; barva zunaj, znotraj in v prelomu: rjava; dodatki: apnenec (fina, zmerna); površina: mehka, močno porozna; TS 10. Stavba 1, kv. 816/B1, SE 01. Inv. št. 20039.

4. Lonec; del ustja z ostenjem; groba keramika; barva zunaj in znotraj: rjava; barva v prelomu: siva; dodatki: apnenec (drobna do groba, zmerna); površina: mehka, rahlo porozna; TS 3. Stavba 1, kv. 717/D2, SE 11. Inv. št. 20438.

5. Lonec; del ustja z ostenjem; groba keramika; barva zunaj, znotraj in v prelomu: črna; dodatki: apnenec (drobna, zmerna); površina: trda; TS 8. Stavba 1, kv. 816/B1, SE 09. Inv. št. 20044.

6. Lonec; del ustja z ostenjem; groba keramika; barva zunaj, znotraj in v prelomu: črna; dodatki: apnenec (zelo fina do fina, redka); površina: mehka, rahlo porozna; TS 9. Stavba 1, kv. 667/A4, SE 23. Inv. št. 20702.

7. Lonec; del ustja z ostenjem; groba keramika; barva zunaj, znotraj in v prelomu: črna; dodatki: apnenec (drobna, zmerna), sljuda (zelo fina, zmerna); površina: trda; TS 8; metličenje. Stavba 1, kv. 817. Inv. št. 22040.

8. Lonec; del ustja z ostenjem; groba keramika; barva zunaj in znotraj: svetlo rjava; barva v prelomu: siva; dodatki: apnenec (drobna, zmerna), sljuda (zelo fina, redka); površina: mehka, rahlo porozna; TS 3. Stavba 1, kv. 716/D1, D2, SE 10. Inv. št. 20185, 20197.

– Modrijan 2010, sl. 6: 4, Modrijan 2011, sl. 5: 4.

9. Lonec; del ustja z ostenjem; groba keramika; barva zunaj in znotraj: rjava; barva v prelomu: siva; dodatki: apnenec (drobna, zmerna); površina: mehka, močno porozna; TS 10. Stavba 1, kv. 767/A2, SE 10. Inv. št. 20166.

10. Lonec; del ustja z ostenjem; groba keramika; barva zunaj in znotraj: rjava; barva v prelomu: siva; dodatki: apnenec (drobna, zmerna); površina: mehka, rahlo porozna; TS 10. Stavba 1, kv. 767/A2, SE 10. Inv. št. 20165.

11. Lonec; del ustja z ostenjem; groba keramika; barva zunaj in znotraj: rjava; barva v prelomu: siva; dodatki: apnenec (drobna, zmerna), sljuda (zelo fina, redka); površina: mehka, rahlo porozna; TS 5. Stavba 1, kv. 767/A4, SE 10. Inv. št. 20180.

12. Lonec; del ustja z ostenjem; groba keramika; barva zunaj: svetlo in temno rjava; barva znotraj: rjava; barva v prelomu: siva; dodatki: apnenec (fina do drobna, obilna); površina: mehka, porozna; TS 10. Stavba 1, kv. 716/D3, SE 23. Inv. št. 21313.

13. Lonec; del ustja z ostenjem; groba keramika; barva zunaj in znotraj: svetlo rjava; barva v prelomu: siva; dodatki: apnenec (drobna do groba, redka); površina: mehka, porozna; TS 3. Stavba 1, kv. 767/A2, SE 10. Inv. št. 20167.

14. Lonec; del ustja z ostenjem; groba keramika; barva zunaj, znotraj in v prelomu: črna; dodatki: apnenec (fina, zmerna); površina: mehka, rahlo porozna; TS 9. Stavba 1, kv. 767/B2, SE 10. Inv. št. 20193.

15. Lonec; del ustja z ostenjem; groba keramika; barva zunaj in znotraj: siva; barva v prelomu: oranžna; dodatki: apnenec (fina, zmerna); površina: mehka; TS neopr. Stavba 1, kv. 668/D3, SE 08. Inv. št. 21618.

Tabla 97

1. Lonec; del ustja z ostenjem; groba keramika; barva zunaj: svetlo rjava; barva znotraj: oranžna; barva v prelomu: rjava; dodatki: apnenec (drobna do groba, zmerna); površina: trda; TS 3. Stavba 1, kv. 666/B3, SE 24. Inv. št. 20763.

– Modrijan 2010, sl. 4: 3.

2. Lonec; del ustja in ostenja; groba keramika; barva zunaj in znotraj: svetlo rjava; barva v prelomu: siva; dodatki: apnenec (drobna do groba, zmerna); površina: trda; TS 3. Stavba 1, kv. 666/B4, SE 23. Inv. št. 20615.

3. Lonec; del ustja z ostenjem; groba keramika; barva zunaj: črna; barva znotraj in v prelomu: oranžna; dodatki: apnenec (drobna do groba, zmerna); površina: trda; TS 3. Stavba 1, kv. 666/B2, SE 29. Inv. št. 20826.

4. Lonec; del ustja z ostenjem; groba keramika; barva zunaj: siva; barva znotraj: rjava; barva v prelomu: oranžna; dodatki: apnenec (groba, redka); površina: trda; TS 3. Stavba 1, kv. 666/A2, SE 29. Inv. št. 20881.

5. Lonec; del ustja z ostenjem; groba keramika; barva zunaj in znotraj: svetlo rjava; barva v prelomu: siva; dodatki: apnenec (drobna do groba, redka); površina: trda, rahlo porozna; TS 3. Stavba 1, kv. 818/A2, SE 03. Inv. št. 22109.

6. Lonec; del ustja in ostenja; groba keramika; barva zunaj in znotraj: svetlo rjava; barva v prelomu: siva; dodatki: apnenec (drobna, zmerna); površina: trda; TS 1. Stavba 1, kv. 666/C3, SE 23. Inv. št. 20636.

– Modrijan 2010, sl. 4: 2.

7. Lonec; del ustja z ostenjem; groba keramika; barva zunaj, znotraj in v prelomu: črna; dodatki: apnenec (fina, obilna), sljuda (zelo fina, redka); površina: trda; rahlo porozna; TS 13; vrez. Stavba 1, kv. 716/A3, SE 68. Inv. št. 21168.

8. Vrč; 2 dela ostenja in ročaj; groba keramika; barva zunaj, znotraj in v prelomu: črna; dodatki: apnenec (drobna, obilna), sljuda (zelo fina, zmerna); površina: trda, močno porozna; TS 13; enolinijska valovnica, vrez. Stavba 1, kv. 666/A2,A3,B2,B3, SE 34,29. Inv. št. 20533.

9. Vrč; del ostenja z delom ročaja; groba keramika; barva zunaj, znotraj in v prelomu: črna; dodatki: apnenec (drobna, zmerna), sljuda (zelo fina, redka); površina: trda; TS 13. Stavba 1, kv. 817, SE 03. Inv. št. 22164.

10. Vrč; del ročaja; groba keramika; barva zunaj in znotraj: svetlo rjava; barva v prelomu: siva; dodatki: apnenec (fina, redka); površina: trda; TS 1. Stavba 1, kv. 666/A2, SE 56. Inv. št. 20536.

11. Posoda; del ročaja; groba keramika; barva zunaj, znotraj in v prelomu: siva; dodatki: apnenec (drobna, zmerna); sljuda (zelo fina, zmerna); površina: trda; TS 4. Stavba 1, kv. 768, SE 03. Inv. št. 21878.

12. Posoda; del ročaja; groba keramika; barva zunaj, znotraj in v prelomu: črna; dodatki: apnenec (drobna, zmerna); sljuda (zelo fina, redka); površina: trda, rahlo porozna; TS 13. Stavba 1, kv. 816/D1 D2, SE 12. Inv. št. 20121.

13. Vrč; del ročaja; groba keramika; barva zunaj, znotraj in v prelomu: siva; dodatki: apnenec (fina, zmerna); površina: trda; TS 1. Stavba 1, kv. 817, SE 03. Inv. št. 22161.

14. Vrč; del ročaja; groba keramika; barva zunaj, znotraj in v prelomu: oranžna; dodatki: apnenec (fina, zmerna); površina: trda; TS neopr. Stavba 1, kv. 717, SE 23. Inv. št. 21397.

15. Vrč; del ročaja; groba keramika; barva zunaj in znotraj: oranžna; barva v prelomu: črna; dodatki: apnenec (drobna, zmerna); površina: mehka; TS 4. Stavba 1, 669/D4, SE 24. Inv. št. 20888.

16. Vrč; del ročaja; groba keramika; barva zunaj, znotraj in v prelomu: oranžna; dodatki: apnenec (fina, zmerna); površina: mehka; TS neopr. Stavba 1, kv. 616/B3, SE 67. Inv. št. 20869.

Tabla 98

1. Lonec; del ostenja; groba keramika; barva zunaj, znotraj in v prelomu: rjava; dodatki: apnenec (fina, zmerna); površina: trda; TS 6; metličenje. Stavba 1, kv. 719/B2, SE 01. Inv. št. 21482.

2. Lonec; del dna z ostenjem; groba keramika; barva zunaj, znotraj in v prelomu: rjava; dodatki: apnenec (drobna do groba, redka); površina: trda; TS 6; metličenje. Stavba 1, kv. 716/D4, SE 23. Inv. št. 21344.

3. Posoda; del ostenja; groba keramika; barva zunaj, znotraj in v prelomu: rjava; dodatki: apnenec (drobna do fina, zmerna); površina: mehka; TS 9; metličenje. Stavba 1, kv. 717/D3, SE 11. Inv. št. 20454.

4. Posoda; del ostenja; groba keramika; barva zunaj, znotraj in v prelomu: svetlo rjava; dodatki: apnenec (drobna do groba, obilna); površina: trda; TS 3; metličenje. Stavba 1, kv. 718/C1, SE 10. Inv. št. 20495.

5. Posoda; del ostenja; groba keramika; barva zunaj, znotraj in v prelomu: rjava; dodatki: apnenec (drobna do groba, zmerna); površina: trda; TS 6; metličenje. Stavba 1, kv. 716/D4. Inv. št. 20872.

6. Lonec; del ostenja; groba keramika; barva zunaj, znotraj in v prelomu: rjava; dodatki: apnenec (drobna, zmerna); površina: trda; TS 6; metličenje. Stavba 1, kv. 669/A3, SE 29a. Inv. št. 20976.

7. Lonec; del ostenja; groba keramika; barva zunaj: rjava; barva znotraj: svetlo in temno rjava; barva v prelomu: črna; dodatki: apnenec (drobna, zmerna); površina: mehka, porozna; TS 9; metličenje. Stavba 1, kv. 818/B2, SE 03. Inv. št. 22121.

8. Lonec; del ostenja; groba keramika; barva zunaj in znotraj: rjava lisasta; barva v prelomu: črna; dodatki: apnenec (fina, redka); površina: trda, porozna; TS 10; več enolinijskih valovnic, metličenje. Stavba 1, kv. 820/C2, SE 34. Inv. št. 22020.

9. Lonec; del ostenja; groba keramika; barva zunaj, znotraj in v prelomu: črna; dodatki: apnenec (drobna, redka); površina: trda; TS 8; enolinijska valovnica, metličenje. Stavba 1, kv. 718/A1, SE 10. Inv. št. 22020.

10. Lonec; del ostenja; groba keramika; barva zunaj, znotraj in v prelomu: rjava; dodatki: apnenec (drobna, redka); površina: trda; TS 6; metličenje. Stavba 1, kv. 669/B2, SE 24. Inv. št. 20909.

11. Lonec; del ostenja; groba keramika; barva zunaj, znotraj in v prelomu: rjava; dodatki: apnenec (drobna, redka); površina: trda; TS 6; metličenje, večlinijska valovnica. Stavba 1, kv. 616/D3, SE 24. Inv. št. 21330.

12. Lonec; del ostenja; groba keramika; barva zunaj in v prelomu: oranžna; barva znotraj: siva; dodatki: apnenec (drobna, redka); površina: trda; TS neopr.; metličenje, večlinijska valovnica. Stavba 1, kv. 716/D4, SE 24. Inv. št. 21374.

13. Lonec; del ostenja; groba keramika; barva zunaj in znotraj: oranžna; barva v prelomu: siva; dodatki: apnenec (fina, redka); površina: mehka, rahlo porozna; TS neopr.; večlinijska valovnica, metličenje. Stavba 1, kv. 719/C1, SE 24. Inv. št. 20558.

*Tabla 99*

1. Lonec; del ostenja; groba keramika; barva zunaj, znotraj in v prelomu: svetlo rjava; dodatki: apnenec (fina, zmerna); površina: trda; TS 2; metličenje, enolinijska valovnica. Stavba 1, kv. 669/B3, SE 29a. Inv. št. 21445.

2. Lonec; del ostenja; groba keramika; barva zunaj in v prelomu: črna; barva znotraj: oranžna; dodatki: apnenec (drobna do groba, zmerna); površina: trda; TS 14; enolinijski valovnici, vrez, metličenje. Stavba 1, kv. 766/B3, SE 23. Inv. št. 21805.

3. Lonec; del ostenja; groba keramika; barva zunaj, znotraj in v prelomu: črna; dodatki: apnenec; (drobna, zmerna), sljuda (fina, zmerna); površina: trda; TS 4; enolinijski valovnici, vrez. Stavba 1, kv. 666/B1, SE 29. Inv. št. 21012.

4. Lonec; del ostenja; groba keramika; barva zunaj, znotraj in v prelomu: črna; dodatki: apnenec (drobna, zmerna); površina: trda; TS 8; enolinijska valovnica. Stavba 1, kv. 769/D4. Inv. št. 21923.

5. Lonec; del ostenja; groba keramika; barva zunaj, znotraj in v prelomu: črna; dodatki: apnenec (drobna, obilna); površina: mehka, rahlo porozna; TS 8; enolinijska valovnica. Stavba 1, kv. 815/D1. Inv. št. 21994.

6. Posoda; del ostenja; groba keramika; barva zunaj in znotraj: rjava lisasta; barva v prelomu: rjava; dodatki: apnenec (drobna, zmerna); površina: mehka, porozna; TS 10; metličenje, enolinijska valovnica. Stavba 1, kv. 716/B1, SE 06. Inv. št. 21151.

7. Lonec; del ostenja; groba keramika; barva zunaj, znotraj in v prelomu: dodatki: apnenec (fina, redka); površina: trda; TS 8; metličenje, vbodi. Stavba 1, kv. 669/A3, SE 29a. Inv. št. 20585.

8. Posoda; del ostenja; groba keramika; barva zunaj, znotraj in v prelomu: črna; dodatki: apnenec (fina, zmerna); površina: mehka, močno porozna; TS 9; razčlenjeno rebro, metličenje. Stavba 1, kv. 668/D2, SE 28. Inv. št. 20824.

9. Lonec; del ostenja; groba keramika; barva zunaj, znotraj in v prelomu: siva; dodatki: apnenec (fina, redka); površina: trda; TS 8; razčlenjeno rebro. Stavba 1, kv. 769/A2, SE 03. Inv. št. 21917.

11. Lonec; del ostenja; groba keramika; barva zunaj, znotraj in v prelomu: svetlo rjava; dodatki: apnenec (drobna, obilna); površina: trda, rahlo porozna; TS 2; razčlenjeno rebro. Stavba 1, kv. 666/B2,C2. Inv. št. 21602.

12. Lonec; del ostenja; groba keramika; barva zunaj, znotraj in v prelomu: siva; dodatki: apnenec (fina, redka); površina: trda; TS 8; razčlenjeno rebro. Stavba 1, kv. 769/B1, SE 03. Inv. št. 21941.

13. Posoda; del ostenja; groba keramika; barva zunaj, znotraj in v prelomu: siva; dodatki: apnenec (fina, zmerna); površina: trda; TS neopr.; razčlenjeno rebro, metličenje. Stavba 1, kv. 717/D4. Inv. št. 20838.

14. Posoda; del ostenja; groba keramika; barva zunaj, znotraj in v prelomu: siva; dodatki: apnenec (drobna, zmerna); površina: trda; TS neopr.; nerazčlenjeno rebro. Stavba 1, kv. 719/B2, SE 01. Inv. št. 21483.

15. Posoda; del dna z ostenjem; groba keramika; barva zunaj in v prelomu: oranžna; barva znotraj: rjava; dodatki: apnenec (drobna do groba, zmerna); površina: trda; TS 3; kratki vrezi, ki oblikujejo krog. Stavba 1, kv. 717/A4, SE 77. Inv. št. 20813.

16. Posoda; del dna; groba keramika; barva zunaj, znotraj in v prelomu: črna; dodatki: apnenec (drobna, obilna); površina: trda; TS 8; dva niza kratkih vrezov, ki oblikujejo krog, med njima žleb. Stavba 1, kv. 669/B1, SE 29. Inv. št. 22171.

17. Posoda; del dna z ostenjem; groba keramika; barva zunaj: svetlo rjava; barva znotraj: oranžna; barva v prelomu: siva; dodatki: apnenec (drobna, obilna); površina: trda; TS 1; križ iz dveh dvojnih reber. Stavba 1, kv. 716/D4, SE 23. Inv. št. 21339.

– Modrijan 2010, sl. 5: 11

18. Posoda; del dna z ostenjem; groba keramika; barva zunaj, znotraj in v prelomu: črna; dodatki: apnenec (fina, obilna); površina: mehka, rahlo porozna; TS 9; križ iz dveh dvojnih reber. Stavba 1, kv. 666/A3, SE 23. Inv. št. 20700.

– Modrijan 2010, sl. 5: 9.

19. Posoda; 2 dela dna z ostenjem; groba keramika; barva zunaj, znotraj in v prelomu: črna; dodatki: apnenec (drobna, zmerna); površina: trda; TS 8; križ iz dveh dvojnih reber. Stavba 1, kv. 766/B1, SE 23. Inv. št. 21844.

20. Posoda; del dna z ostenjem; groba keramika; barva zunaj in znotraj: svetlo rjava; barva v prelomu: črna; dodatki: apnenec (fina, zmerna); površina: trda; TS 1; rebro. Stavba 1, kv. 718/A2, SE 10. Inv. št. 20354.

– Modrijan 2010, sl. 5: 11.

21. Posoda; del dna z ostenjem; groba keramika; barva zunaj in znotraj: rjava; barva v prelomu: temno siva; dodatki: apnenec (drobna, zmerna); rebro; površina: mehka, močno porozna; TS 10. Stavba 1, kv. 815/D1, SE 14. Inv. št. 21998.

*Tabla 100*

1. Krožnik; del ustja in ostenja; vzhodna sigilata; barva zunaj, znotraj in v prelomu: 2,5YR 6/6; Stavba 3, SE 137, inv. št. 24021.

– Modrijan 2010, sl. 3: 11.

2. Ploščica; afriška sigilata; barva zunaj, znotraj in v prelomu: 5YR 5/8; stavba 2, SE 101. Inv. št. 24002.

3. Lonec; del ustja z ostenjem; glazirana keramika; barva zunaj: 5YR 7/8, lošč 2,5Y 5/6; barva znotraj in v prelomu: 6 YR 6/8. Stavba 3, SE 135.

– Modrijan 2009, sl. 1.2c.

4. Vrč; del ročaja; namizna keramika; barva zunaj, znotraj in v prelomu: 7,7YR 8/3. Stavba 2, SE 101.

5. Vrč; del ostenja; namizna keramika; barva zunaj, znotraj in v prelomu: svetlo rjava; Stavba 3, SE 135.

6. Amfora; del ustja z ostenjem; vzhodnomediterska; barva zunaj in znotraj: 10YR 8/6; barva v prelomu 7,5YR 8/6. Stavba 2, SE 110. Inv. št. 24004.

7. Amfora; deli ostenja; vzhodnomediterska; barva zunaj, znotraj in v prelomu: 5YR 6/8; gosti vzporedni žlebovi. Stavba 2, SE 101. Inv. št. 24006.

– Modrijan 2010, sl. 3: 2.

8. Amfora; del ostenja; vzhodnojadranska; barva zunaj: 7,5YR 8/4; barva znotraj in v prelomu: 7,5YR 5/6. Stavba 2, SE 115.

9. Amfora; del ostenja; vzhodnomediterska; barva zunaj: 7,5YR 8/4; barva znotraj in v prelomu: 2,5YR 6/8. Stavba 3, SE 135.

10. Amfora; del ostenja; vzhodnomediterska; barva zunaj: 5YR 6/6; barva znotraj in v prelomu: 5YR 6/2. Stavba 3, SE 162.

*Tabla 101*

1. Amfora; del ostenja; vzhodnomediterska; barva zunaj: 7,5YR 7/8; barva znotraj in v prelomu: 7,5YR 6/8. Stava 3, SE 135.

2. Amfora; del ostenja; vzhodnomediterska; barva zunaj: 7,5YR 7/6; barva znotraj in v prelomu: 5YR 6/8: Stavba 3, SE 137.

3. Krožnik ali skleda; del dna; afriška sigilata; barva zunaj, znotraj in v prelomu: 2.5YR 5/8. Severna cerkev – ladja, SE 58. Inv. št. 24056.

4. Lonec; deli ustja, ostenja in dna; glazirana keramika; barva zunaj: 5YR 6/8, lošč 2,5Y 4/3; barva znotraj: 5YR 6/8; barva v prelomu: 5YR 6/8; vbodi. Prostor med osrednjo in južno cerkvijo, SE 103. Inv. št. 24129.

– Modrijan 2009, sl. 1.2b.

5. Vrč; deli ostenja; namizna keramika; barva zunaj in znotraj: 7,7 YR 8/3, premaz 2,5, YR 6/6; barva v prelomu: 7,7 YR 8/3. Prostor med osrednjo in južno cerkvijo, SE 108. Inv. št. 24123.

6. Amfora; del ostenja; vzhodnomediterska; barva znotraj in v prelomu: 2,5YR 6/8; gosti vzporedni žlebovi. Prostor med osrednjo in južno cerkvijo, SE 93. Inv. št. 24121.

– Modrijan 2010, sl. 3: 9.

7. Amfora; cela; afriška; barva zunaj in v prelomu: 10YR 8/6; barva znotraj: 5YR 7/6. Osrednja cerkev – prezbiterij, SE 26. Inv. št. 24137.

– Modrijan 2010, sl. 3: 10.

*Tabla 102*

1. Skleda; del ustja z ostenjem; groba keramika; barva zunaj, znotraj in v prelomu: svetlo rjava; dodatki: apnenec (drobna, zmerna); površina: mehka, močno porozna; TS 10. Stavba 2, SE 101. Inv. št. 24017.

2. Skleda; del ustja z ostenjem; groba keramika; barva zunaj, znotraj in v prelomu: svetlo rjava; dodatki: apnenec (fina, zmerna), sljuda (zelo fina, redka); površina: trda, rahlo porozna; TS 02. Stavba 3, SE 165. Inv. št. 24037.

3. Skleda; del ustja; groba keramika; barva zunaj, znotraj in v prelomu: črna; dodatki: apnenec (fina, zmerna); mehka, rahlo porozna; TS 9. Stavba 2, SE 106. Inv. št. 24027.

4. Posoda; del ustja in ostenja; groba keramika; barva zunaj, znotraj in v prelomu: črna; dodatki: apnenec (drobna do fina, redka); površina: trda, rahlo porozna; TS 08. Stavba 2, SE 106. Inv. št. 24025.

5. Skleda; del ustja z ostenjem; groba keramika; barva zunaj, znotraj in v prelomu: črna; dodatki: apnenec (drobna, zmerna); površina: mehka; TS 8. Stavba 3, SE 170. Inv. št. 24033.

6. Lonec; del ustja z ostenjem; groba keramika; barva zunaj, znotraj in v prelomu: rjava; dodatki: apnenec (drobna, zmerna); površina: mehka; TS neopr. Stavba 3, SE 175. Inv. št. 24136.

7. Lonec; del ustja; groba keramika; barva zunaj, znotraj in v prelomu: črna; dodatki: apnenec (drobna, redka); površina: mehka, rahlo porozna; TS 3. Stavba 3, SE 175. Inv. št. 24040.

8. Lonec; del ustja in ostenja; groba keramika; barva zunaj, znotraj in v prelomu: rjava; dodatki: apnenec (fina, zmerna); površina: trda; TS 9. Stavba 2, SE 122. Inv. št. 24014.

9. Lonec; del ustja z ostenjem; groba keramika; barva zunaj, znotraj in v prelomu: svetlo rjava; dodatki: apnenec (drobna, redka); površina: mehka, rahlo porozna; TS10. Stavba 3, SE 137. Inv. št. 24022.

10. Lonec; del ustja; groba keramika; barva zunaj, znotraj in v prelomu: svetlo tjava; dodatki: dodatki: apnenec (groba, redka); površina: trda; TS 02. Stavba 3, SE 137. Inv. št. 24028.

11. Lonec; del ustja in ostenja; groba keramika; barva zunaj in znotraj: svetlo rjava; barva v prelomu: siva; dodatki: apnenec (drobna, zmerna); površina: trda; TS 02. Stavba 2, SE 106. Inv. št. 24026.

12. Lonec; del ustja in ostenja; groba keramika; barva zunaj, znotraj in v prelomu: oranžna; dodatki: apnenec (groba, redka); površina: mehka, močno porozna; TS 10. Stavba 2, SE 106. Inv. št. 24005.

13. Lonec; del ustja z ostenjem; groba keramika; barva zunaj: črna; barva znotraj: oranžna; barva v prelomu: črna-oranžna; dodatki: apnenec (fina, zmerna); površina: trda, rahlo porozna; TS neopr. Stavba 2, SE 106. Inv. št. 24031.

14. Lonec; del ustja in ostenja; groba keramika; barva zunaj, znotraj in v prelomu: črna; dodatki: apnenec (fina, zmerna); površina: trda, rahlo porozna; TS 08; Stavba 2, SE 92. Inv. št. 24009.

15. Lonec; del ustja; groba keramika; barva zunaj, znotraj in v prelomu: črna; dodatki: apnenec (drobna, redka); površina: trda; TS 04. Stavba 3, SE 175. Inv. št. 24041.

16. Lonec; del ustja in ostenja; groba keramika; barva zunaj, znotraj in v prelomu: rjava; dodatki: apnenec (drobna, redka); površina: trda, rahlo porozna; TS 09. Stavba 2, SE 121. Inv. št. 24008.

*Tabla 103*

1. Lonec; del ustja in ostenja; groba keramika; barva zunaj, znotraj in v prelomu: črna; dodatki: apnenec (drobna, zmerna); površina: trda, rahlo porozna; TS 13. Stavba 3, SE 161. Inv. št. 24038.

2. Skleda; del ustja z ostenjem; groba keramika; barva zunaj, znotraj in v prelomu: svetlo rjava; dodatki: apnenec (drobna do groba, redka); površina: mehka, močno porozna; enolinijska valovnica, vrez; TS10. Severna cerkev – ladja, SE 15. Inv. št. 24045.

– Modrijan 2010, sl. 6: 6; 2011, sl. 5: 5.

3. Skleda; del ustja z ostenjem; groba keramika; barva zunaj, znotraj in v prelomu: svetlo rjava; dodatki: apnenec (drobna do groba, redka); površina: mehka; TS 3. Osrednja cerkev – ladja, SE 14. Inv. št. 24053.

4. Skleda; del ustja z ostenjem; groba keramika; barva zunaj, znotraj in v prelomu: rjava; dodatki: apnenec (zelo fina redka); površina: mehka, močno porozna; TS 10. Osrednja cerkev – ladja, SE 02. Inv. št. 24050.

5. Skleda; del ustja z ostenjem; groba keramika; barva zunaj, znotraj in v prelomu: svetlo rjava; dodatki: apnenec (groba, obilna); površina: mehka, močno porozna. Osrednja cerkev – ladja, SE 02. Inv. št. 24047.

6. Skleda; del ustja z ostenjem; groba keramika; barva zunaj, znotraj in v prelomu: siva; dodatki: apnenec (fina, redka); površina: trda; enolinijska valovnica; TS 4. Osrednja cerkev – ladja, SE 02. Inv. št. 24062.

7. Skleda; del ustja z ostenjem; groba keramika; barva zunaj, znotraj in v prelomu: rjava; dodatki: apnenec (drobna



do groba, redka); površina: trda; TS 3. Severna cerkev – ladja, SE 02. Inv. št. 24065.

8. Lonec; del ustja z ostenjem; groba keramika; barva zunaj, znotraj in v prelomu: siva; dodatki: apnenec (fina, redka); površina: trda; TS 13. Severna cerkev – ladja, SE 22. Inv. št. 24049.

9. Lonec; del ustja z ostenjem; groba keramika; barva zunaj, znotraj in v prelomu: siva; dodatki: apnenec (drobna, redka); površina: trda; TS 8. Severna cerkev – ladja, SE 02. Inv. št. 24061.

10. Lonec; del ustja z ostenjem; groba keramika; barva zunaj, znotraj in v prelomu: črna; dodatki: apnenec (fina, obilna); površina: trda; TS 8. Severna cerkev – narteks. Inv. št. 24060.

#### Tabla 104

1. Lonec; del ustja z ostenjem; groba keramika; barva zunaj, znotraj in v prelomu: črna; dodatki: apnenec (drobna, zmerna); površina: trda; TS 08. Severna cerkev. Inv. št. 24051.  
– Modrijan 2010, sl. 6: 1; 2011, sl. 5: 1.

2. Lonec; del ustja z ostenjem; groba keramika; barva zunaj, znotraj in v prelomu: rjava; dodatki: apnenec (fina, obilna); površina: trda, močno porozna; TS 10. Osrednja cerkev – ladja, SE 32. Inv. št. 24067.

3. Lonec; del ustja z ostenjem; groba keramika; barva zunaj, znotraj in v prelomu: siva; dodatki: apnenec (drobna, pogosta), sljuda (zelo fina, zmerna); površina: trda; TS 8. Osrednja cerkev – ladja, SE 15. Inv. št. 24054.

4. Lonec; del ustja z ostenjem; groba keramika; barva zunaj, znotraj in v prelomu: črna; dodatki: apnenec (drobna, redka); površina: trda; TS 5. Osrednja cerkev – narteks, SE 02. Inv. št. 24044.

5. Lonec; del ustja z ostenjem; groba keramika; barva zunaj: črna in rjava; barva znotraj: črna; barva v prelomu: rjava; dodatki: apnenec (fina do groba, zmerna); površina: trda. Osrednja cerkev. Inv. št. 24046.

6. Lonec; del ustja z ostenjem; groba keramika; barva zunaj, znotraj in v prelomu: črna; dodatki: apnenec (fina, redka); površina: trda, rahlo porozna. Osrednja cerkev – prezbiterij, SE 02. Inv. št. 24068.

7. Lonec; del ustja z ostenjem; barva zunaj: črna in rjava; barva znotraj: črna; barva v prelomu: rjava; dodatki: apnenec (fina do groba, zmerna); površina, mehka, močno porozna; TS 05. Osrednja cerkev – ladja. Inv. št. 24048.

8. Lonec; del ustja z ostenjem; barva zunaj, znotraj in v prelomu: rjava; dodatki: apnenec (fina, obilna); površina: trda; TS 8. Osrednja cerkev – ladja, SE 02. Inv. št. 24043.

9. Pokrov; barva zunaj, znotraj in v prelomu: siva; dodatki: apnenec (fina, zmerna); površina: trda, rahlo porozna; TS 04. Severna cerkev. Inv. št. 24058.

10. Skleda; barva zunaj: črna in rjava; barva znotraj: rjava; barva v prelomu: črna; dodatki: apnenec (groba, redka); TS 14. Prostor med osrednjo in južno cerkvijo, SE 92. Inv. št. 24071.

#### Tabla 105

1. Skleda; del ustja z ostenjem; barva zunaj, znotraj in v prelomu: črna; dodatki: apnenec (drobna, zmerna), zdrobljena keramika (groba, redka); površina: trda; TS 8; enolinijska valovnica, vrez. Prostor med osrednjo in južno cerkvijo, SE 100. Inv. št. 24107.

2. Skleda; del ustja z ostenjem; barva zunaj, znotraj in v prelomu: črna; dodatki: apnenec (drobna, zmerna); površina: trda; TS 8. Prostor med osrednjo in južno cerkvijo, SE 89. Inv. št. 24082.

3. Skleda; del ustja z ostenjem; barva zunaj, znotraj in v prelomu: črna; dodatki: apnenec (drobna, obilna), sljuda (zelo fina, obilna); površina: trda; TS 8; enolinijska valovnica, vrezi, metličenje. Prostor med osrednjo in južno cerkvijo, SE 99. Inv. št. 24076.

4. Skleda; del ustja z ostenjem; barva zunaj, znotraj in v prelomu: črna; dodatki: apnenec (drobna do fina, obilna); površina: trda; TS 8. Prostor med osrednjo in južno cerkvijo, SE 92. Inv. št. 24096.

5. Skleda; del ustja z ostenjem; barva zunaj, znotraj in v prelomu: črna; dodatki: apnenec (drobna, redka); površina: trda; TS 4; večlinijska valovnica, žlebovi, metličenje. Prostor med osrednjo in južno cerkvijo, SE 100. Inv. št. 24104.  
– Modrijan 2010, sl. 2: 12.

6. Skleda; del ustja z ostenjem; barva zunaj, znotraj in v prelomu: črna; dodatki: apnenec (drobna, zmerna); površina: trda; TS 8. Prostor med osrednjo in južno cerkvijo, SE 95. Inv. št. 24074.

7. Skleda; del ustja z ostenjem; barva zunaj, znotraj in v prelomu: rjava; dodatki: apnenec (drobna, zmerna); površina: trda; TS 2; metličenje. Prostor med osrednjo in južno cerkvijo, SE 92. Inv. št. 24100.

8. Krožnik; del ustja z ostenjem; barva zunaj, znotraj in v prelomu: siva; dodatki: apnenec (drobna, zmerna), sljuda (zelo fina, zmerna); površina: trda; TS neopr.; dve enolinijski valovnici, žlebljenje, metličenje. Prostor med osrednjo in južno cerkvijo, SE 84. Inv. št. 24090.  
– Modrijan 2010, sl. 5: 8.

9. Lonec; del ustja z ostenjem; barva zunaj, znotraj in v prelomu: črna; dodatki: apnenec (drobna, redka); površina: trda; TS 8. Prostor med osrednjo in južno cerkvijo. Inv. št. 24091.

10. Lonec; del ustja z ostenjem; barva zunaj, znotraj in v prelomu: črna; dodatki: apnenec (fina, redka); površina: trda; TS 8. Prostor med osrednjo in južno cerkvijo, SE 82. Inv. št. 24097.

11. Lonec; del ustja z ostenjem; barva zunaj, znotraj in v prelomu: siva; dodatki: apnenec (drobna, obilna); površina: trda; TS 8. Prostor med osrednjo in južno cerkvijo, SE 111. Inv. št. 24118.

#### Tabla 106

1. Lonec; del ustja z ostenjem; barva zunaj, znotraj in v prelomu: siva; dodatki: apnenec (drobna, redka); površina: trda; TS 8. Prostor med osrednjo in južno cerkvijo, SE 89. Inv. št. 24080.

2. Lonec; del ustja z ostenjem; barva zunaj, znotraj in v prelomu: siva; dodatki: apnenec (drobna, redka); površina: trda; TS 8. Prostor med osrednjo in južno cerkvijo, SE 96. Inv. št. 24103.

3. Lonec; del ustja z ostenjem; barva zunaj, znotraj in v prelomu: črna; dodatki: apnenec (groba, redka), zdrobljena keramika (zelo groba, zmerna); površina: trda; TS 12. Prostor med osrednjo in južno cerkvijo, SE 96. Inv. št. 24102.

4. Lonec; del ustja z ostenjem; barva zunaj, znotraj in v prelomu: črna; dodatki: apnenec (drobna do fina, redka); površina: trda; TS 9. Prostor med osrednjo in južno cerkvijo, SE 02. Inv. št. 24088.

5. Lonec; del ustja z ostenjem; barva zunaj, znotraj in v prelomu: črna; dodatki: apnenec (fina, redka), zdrobljena keramika (zelo groba, zmerna); površina: trda; TS 9. Prostor med osrednjo in južno cerkvijo, SE 02. Inv. št. 24086.

6. Lonec; del ostenja; barva zunaj, znotraj in v prelomu: črna; dodatki: apnenec (drobna, obilna), sljuda (fina, obilna); površina: trda; TS 8; enolinijska valovnica, vrezi. Prostor med osrednjo in južno cerkvijo. Inv. št. 24092.

7. Lonec; del dna; barva zunaj, znotraj in v prelomu: siva; dodatki: apnenec (groba, redka); površina: trda; TS 4; vrez. Prostor med osrednjo in južno cerkvijo, SE 100. Inv. št. 24105.

8. Lonec; del dna; barva zunaj, znotraj in v prelomu: črna; dodatki: apnenec (drobna, redka); površina: trda; TS 8; enolinijska valovnica, metličenje. Prostor med osrednjo in južno cerkvijo. Inv. št. 24113.

9. Skleda; del ustja z ostenjem; barva zunaj; temno rjava; barva znotraj in v prelomu: črna; dodatki: apnenec (fina, obilna); površina: trda, rahlo porozna; TS 13. Cisterna. Inv. št. 24133.

10. Skleda; del ustja z ostenjem; barva zunaj, znotraj in v prelomu: rjava; dodatki: apnenec (drobna, zmerna); površina: mehka; TS 2. Cisterna. Inv. št. 24133.

11. Skleda; del ustja z ostenjem; barva zunaj in znotraj temno rjava; barva prelomu: črna; dodatki: apnenec (drobna, zmerna); površina: trda, rahlo porozna; TS 13. Cisterna, SE 241. Inv. št. 24133.

– Modrijan 2010, sl. 6: 7; 2011, sl. 5: 2.

12. Lonec; del ustja z ostenjem; barva zunaj in znotraj: temno rjava; barva v prelomu: črna; dodatki: apnenec (fina do groba, obilna); površina: trda, rahlo porozna; TS 13. Cisterna, SE 241. Inv. št. 24130.

– Modrijan 2010, sl. 6: 2; 2011, sl. 5: 6.

12. TABLE / PLATES

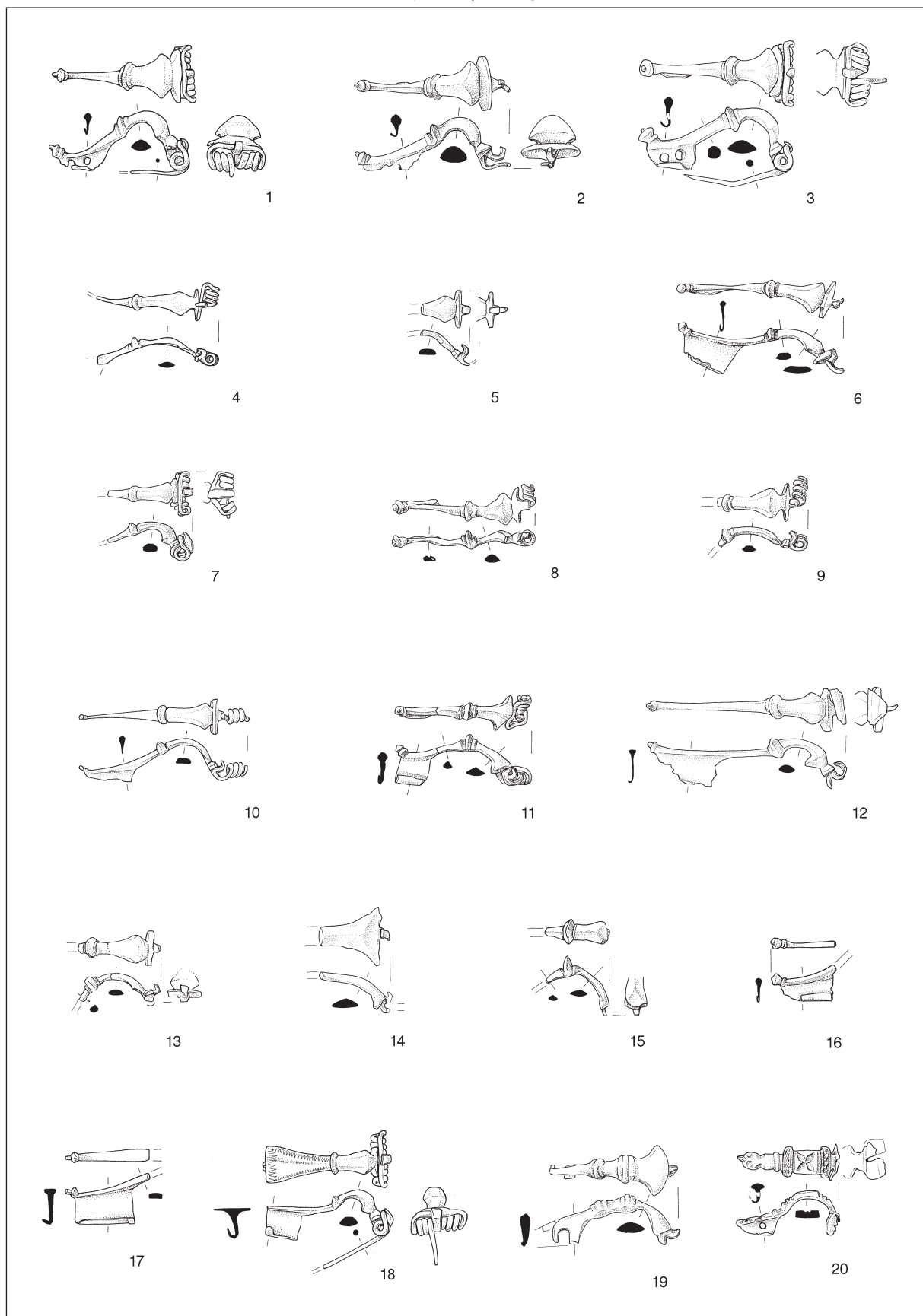

T. 1: Tonovcov grad, stavba 1. Vse bron. M. = 1:2.

Pl. 1: Tonovcov grad, building 1. All bronze. Scale = 1:2.

TABLE / PLATES

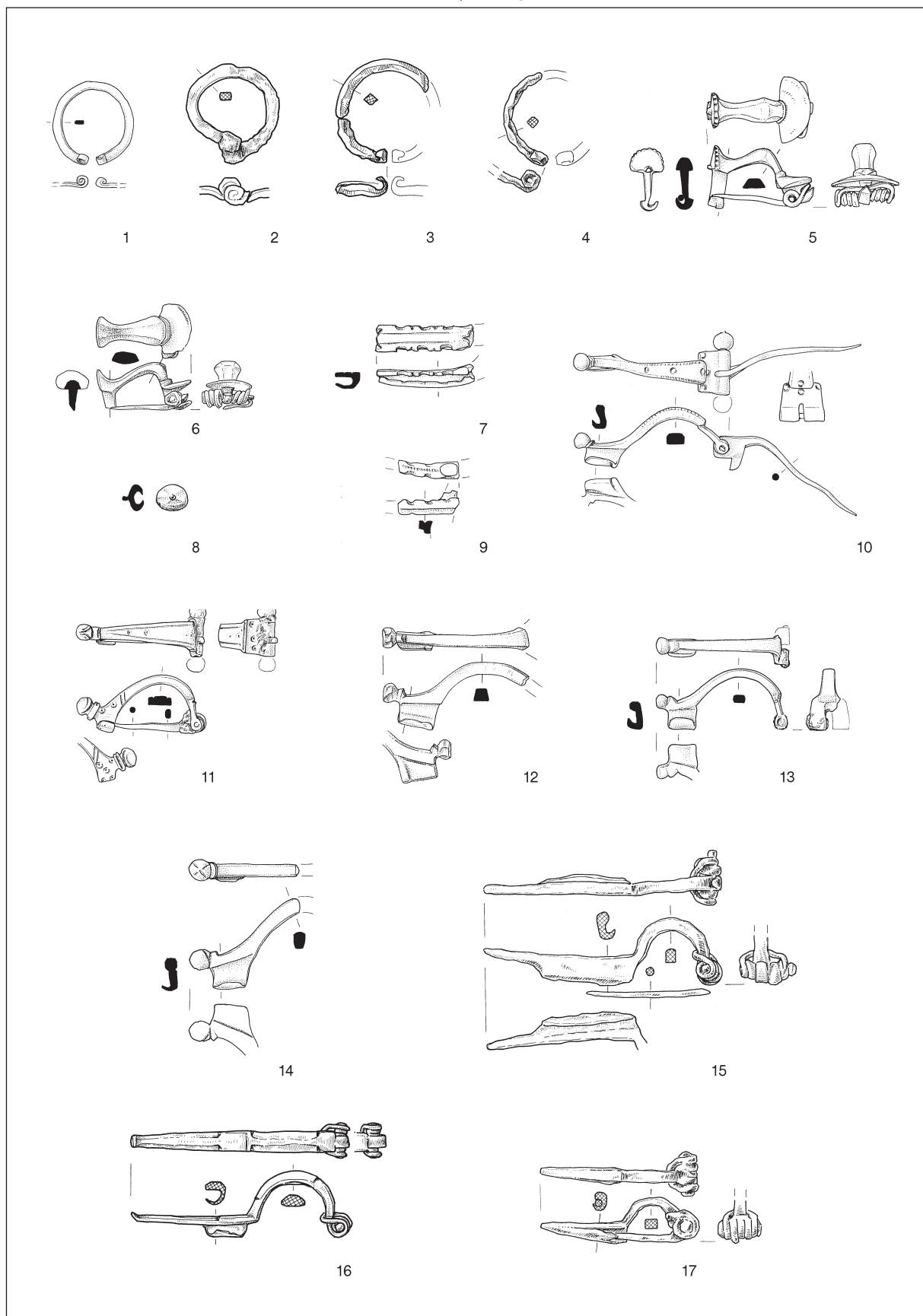

T. 2: Tonovcov grad, stavba 1. 1,5-14 bron; 2-4,15-17 železo. M. = 1:2.

Pl. 2: Tonovcov grad, building 1. 1,5-14 bronze; 2-4,15-17 iron. Scale = 1:2.

TABLE / PLATES

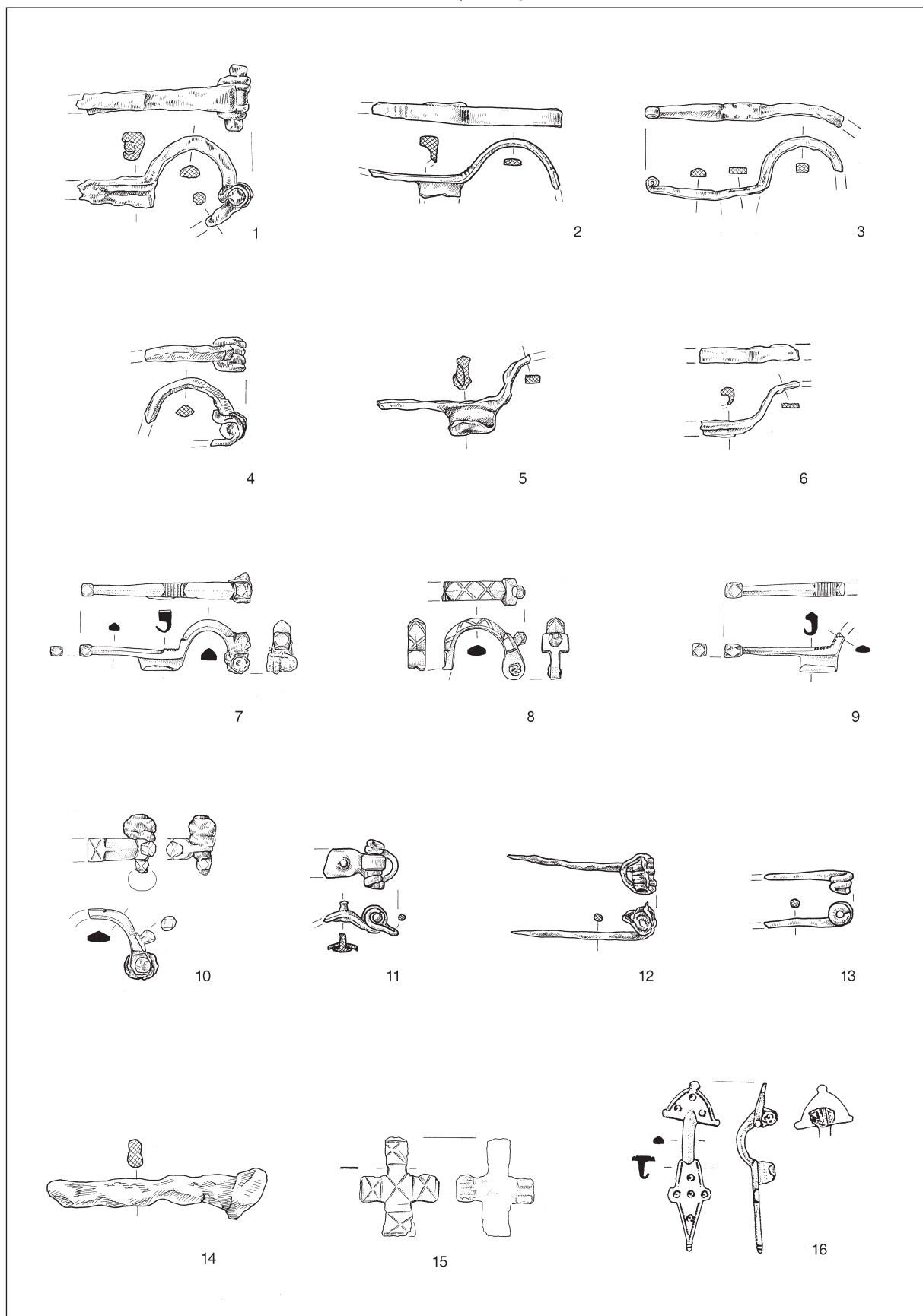

T. 3: Tonovcov grad, stavba 1. 1-6,11-14 železo; 7-10,15-16 bron. M. = 1:2.

Pl. 3: Tonovcov grad, building 1. 1-6,11-14 iron; 7-10,15-16 bronze. Scale = 1:2.

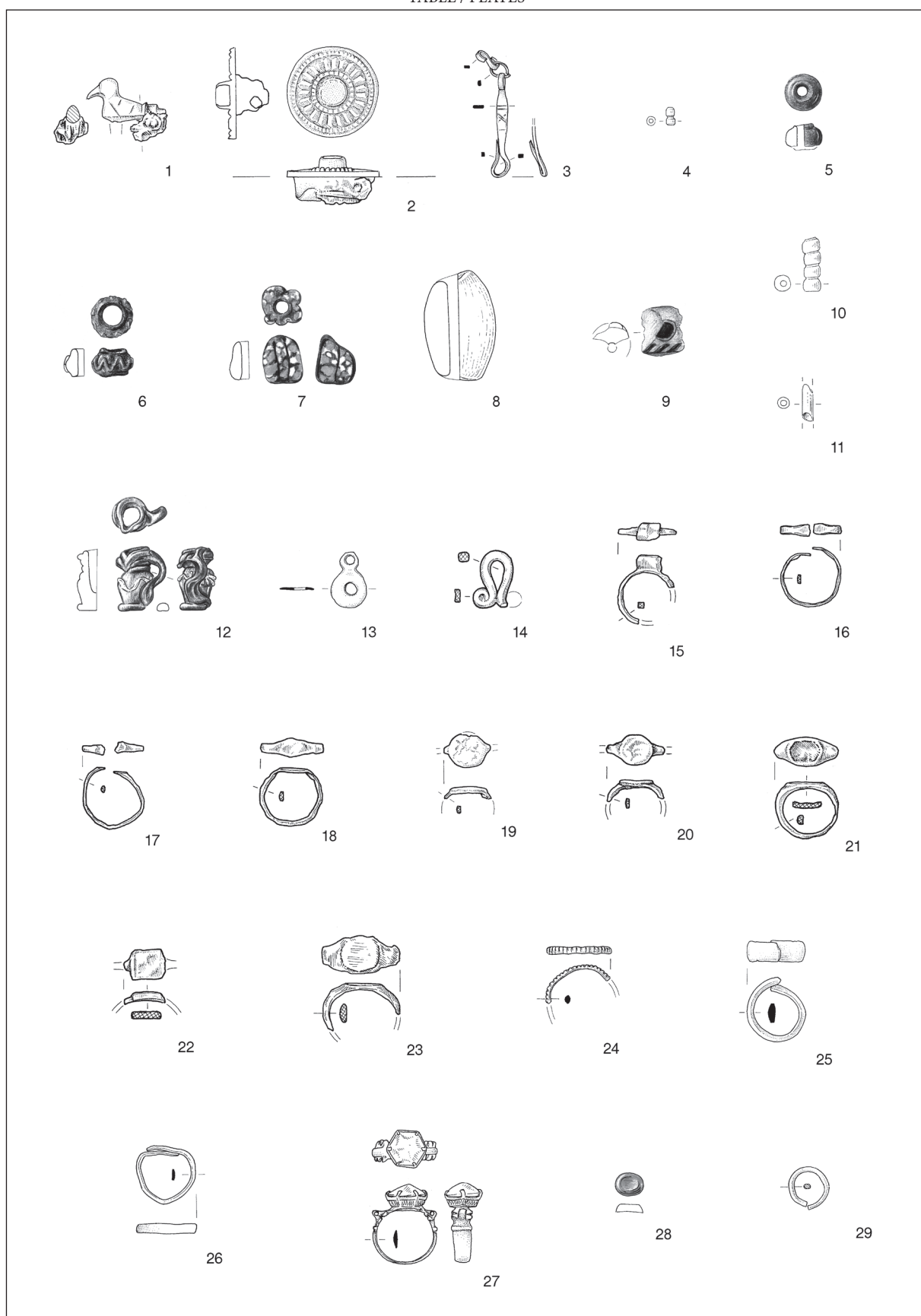

T. 4: Tonovcov grad, stavba 1. 1-2 srebro, železo; 3,13,24-26 bron; 4-7,9-12 steklo; 8 kalcedon; 14-23 železo; 27 bron, steklo ali kamen; 28 steklo ali kamen; 29 srebro. M. 1, 3-29 = 1:2, 2 = 1:1.

Pl. 4: Tonovcov grad, building 1. 1-2 silver, iron; 3,13, 24-26 bronze; 4-7,9-12 glass; 8 chalcedony; 14-23 iron; 27 bronze, glass or stone; 28 glass or stone; 29 silver. Scale 1, 3-29 = 1:2, 2 = 1:1.

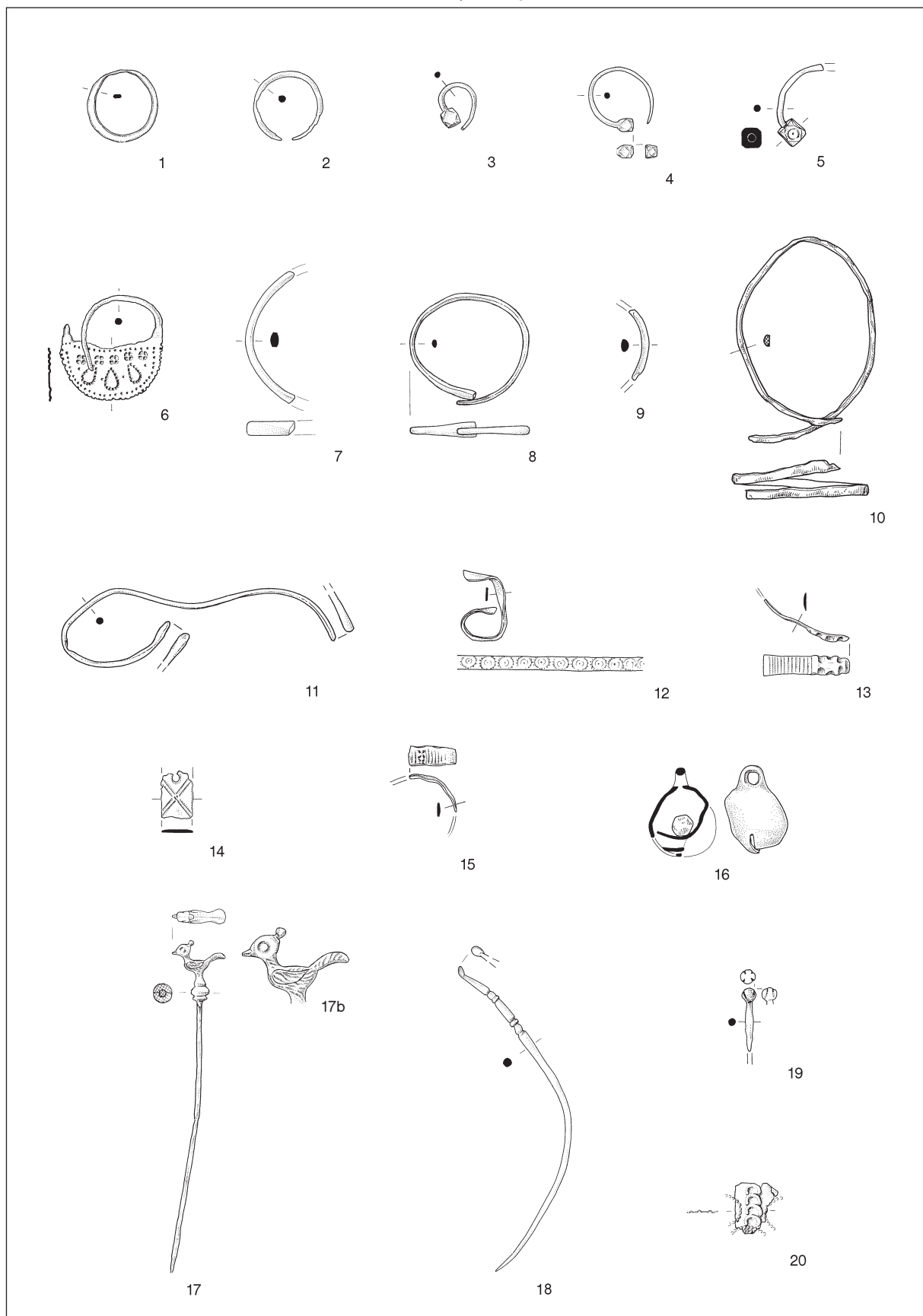

T. 5: Tonovcov grad, stavba 1. 1-9,11-15,18-19 bron; 10 železo; 16 bron, kamen; 17,20 srebro. M. = 1:2, 17b = 1:1.  
 Pl. 5: Tonovcov grad, building 1. 1-9,11-15,18-19 bronz; 10 iron; 16 bronze, stone; 17,20 silver. Scale = 1:2, 17b = 1:1.

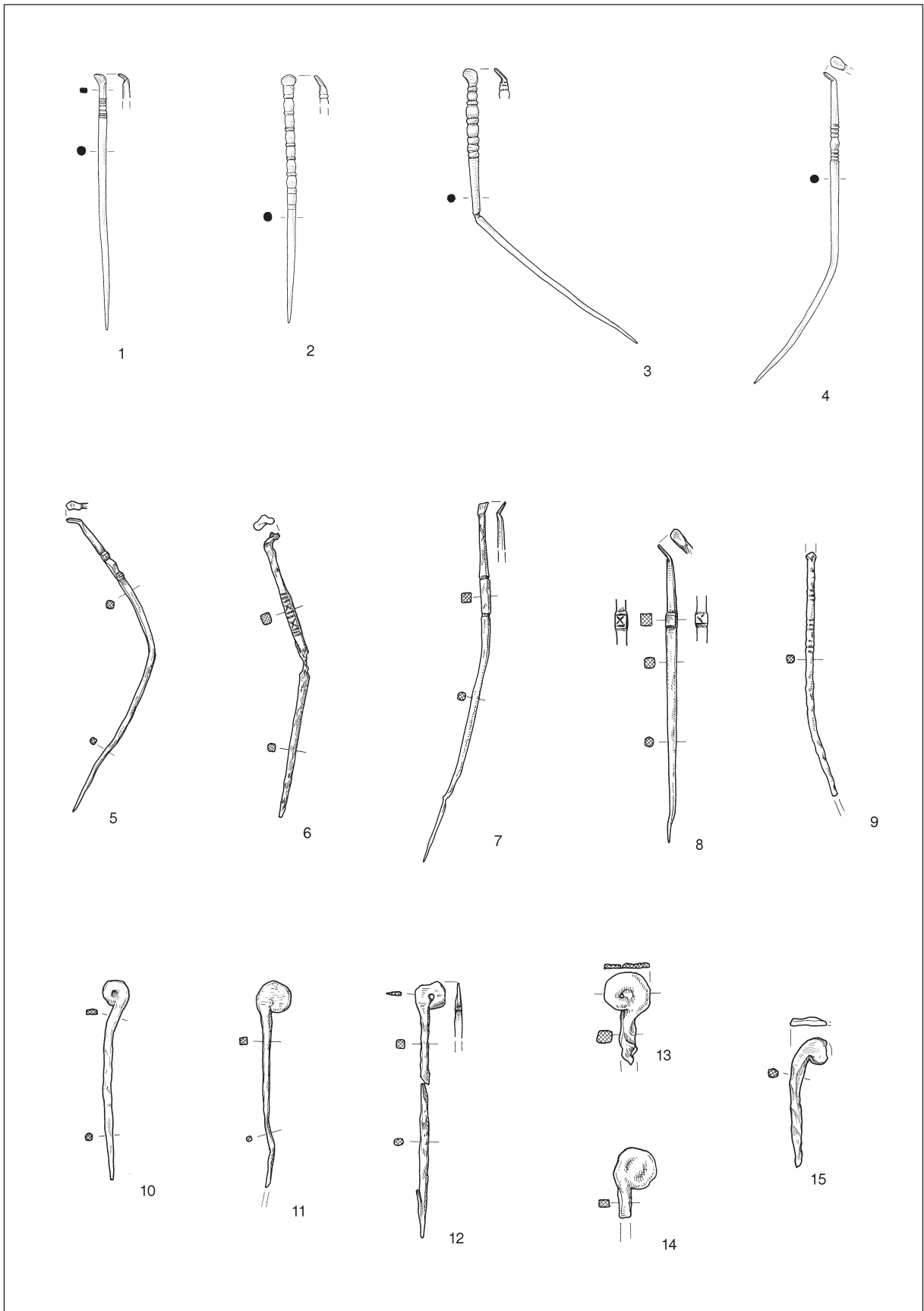

T. 6: Tonovcov grad, stavba 1. 1-4 bron; 5-15 železo. M. = 1:2.

Pl. 6: Tonovcov grad, building 1. 1-4 bronze; 5-15 iron. Scale = 1:2.



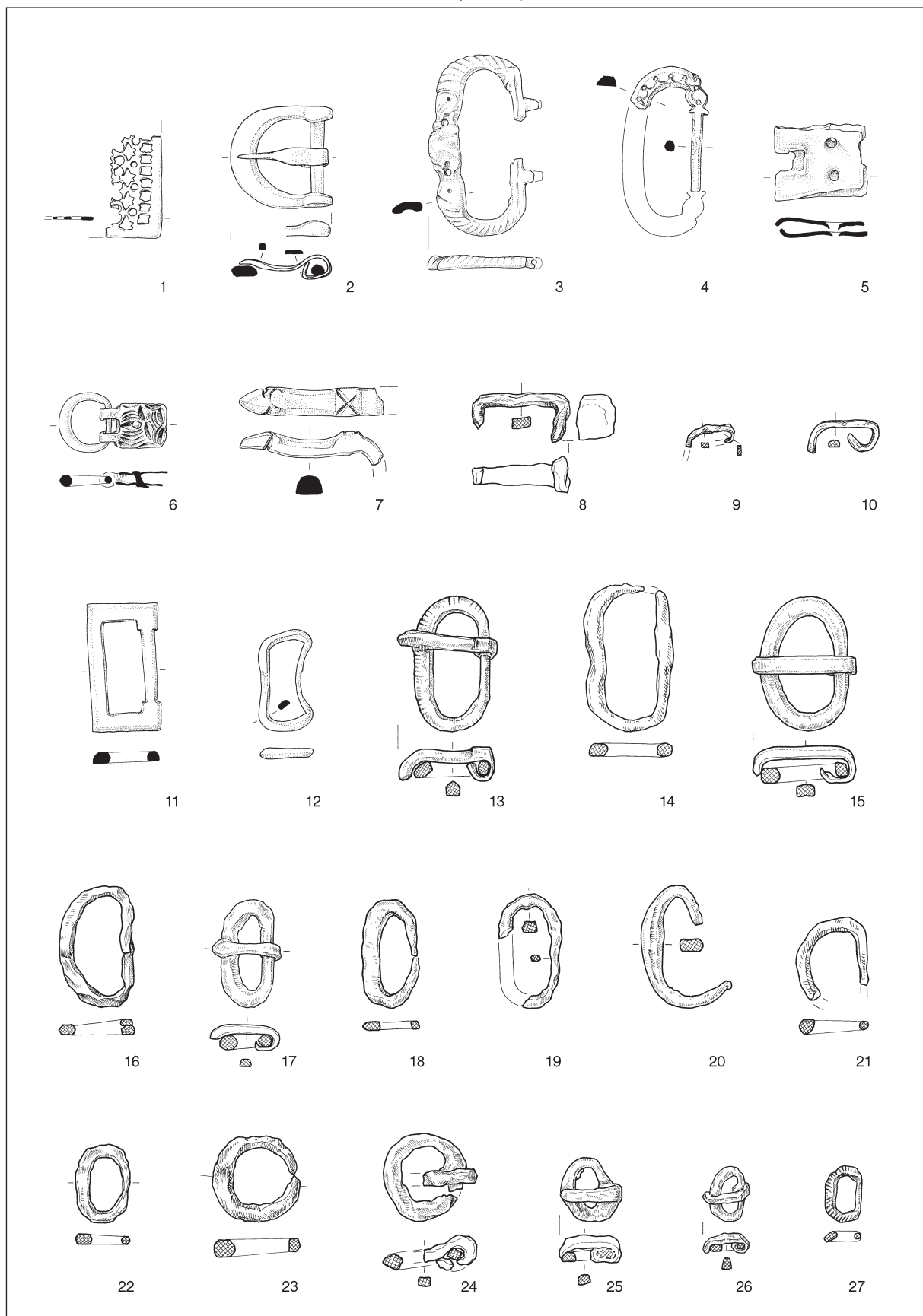

T. 7: Tonovcov grad, stavba 1. 1-7,11-12 bron; 8-10; 13-27 železo. M. = 1:2.

Pl. 7: Tonovcov grad, building 1. 1-7,11-12 bronze; 8-10; 13-27 iron. Scale = 1:2.

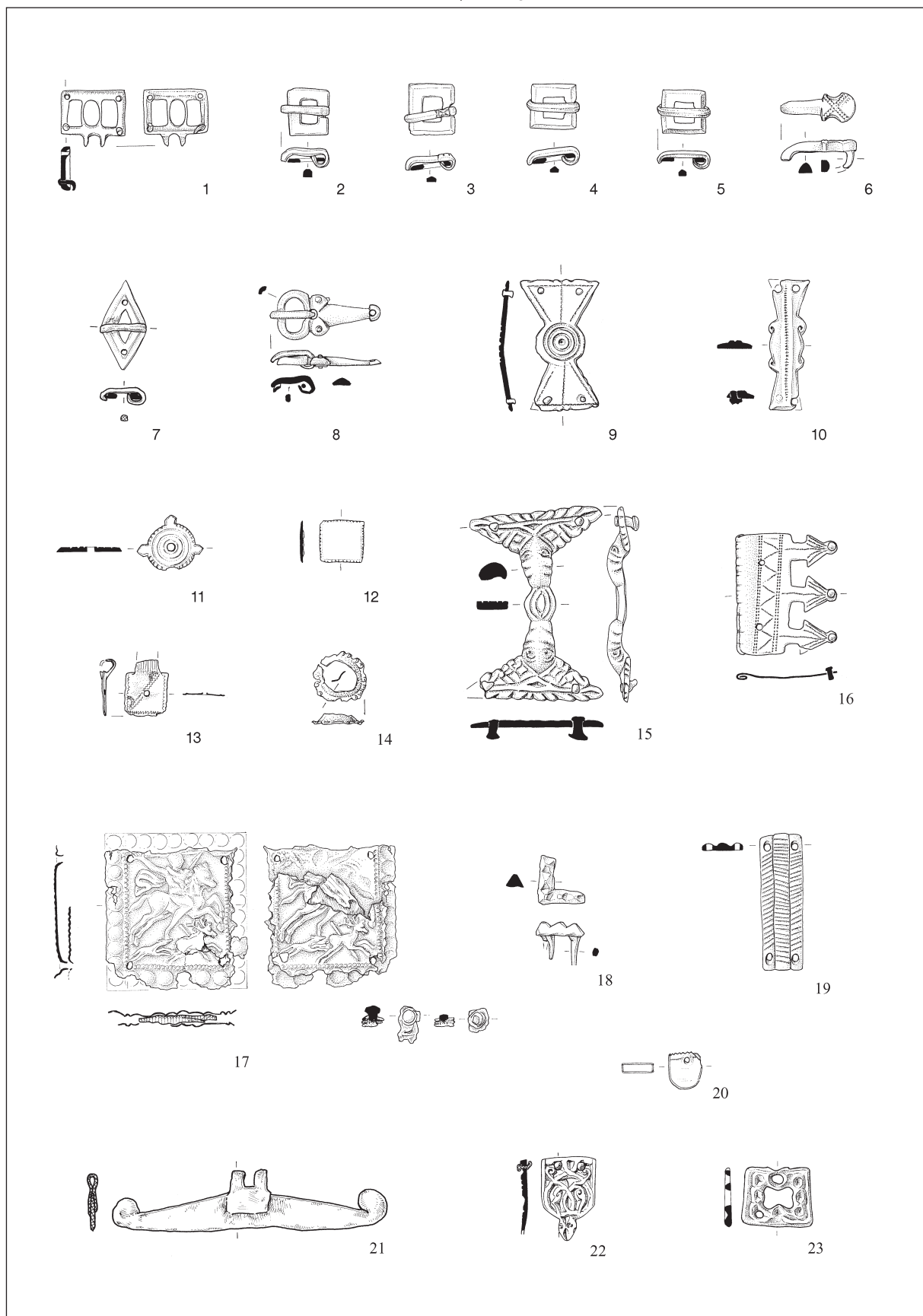

T. 8: Tonovcov grad, stavba 1. 1–6,8–19, 23 bron; 7 bron, železo; 20 srebro; 21 bron, železo, pozlata. M. = 1:2.

Pl. 8: Tonovcov grad, building 1. 1–6,8–19, 23 bronze; 7 bronze, iron; 20 silver; 21 bronze, iron, gilding. Scale = 1:2.

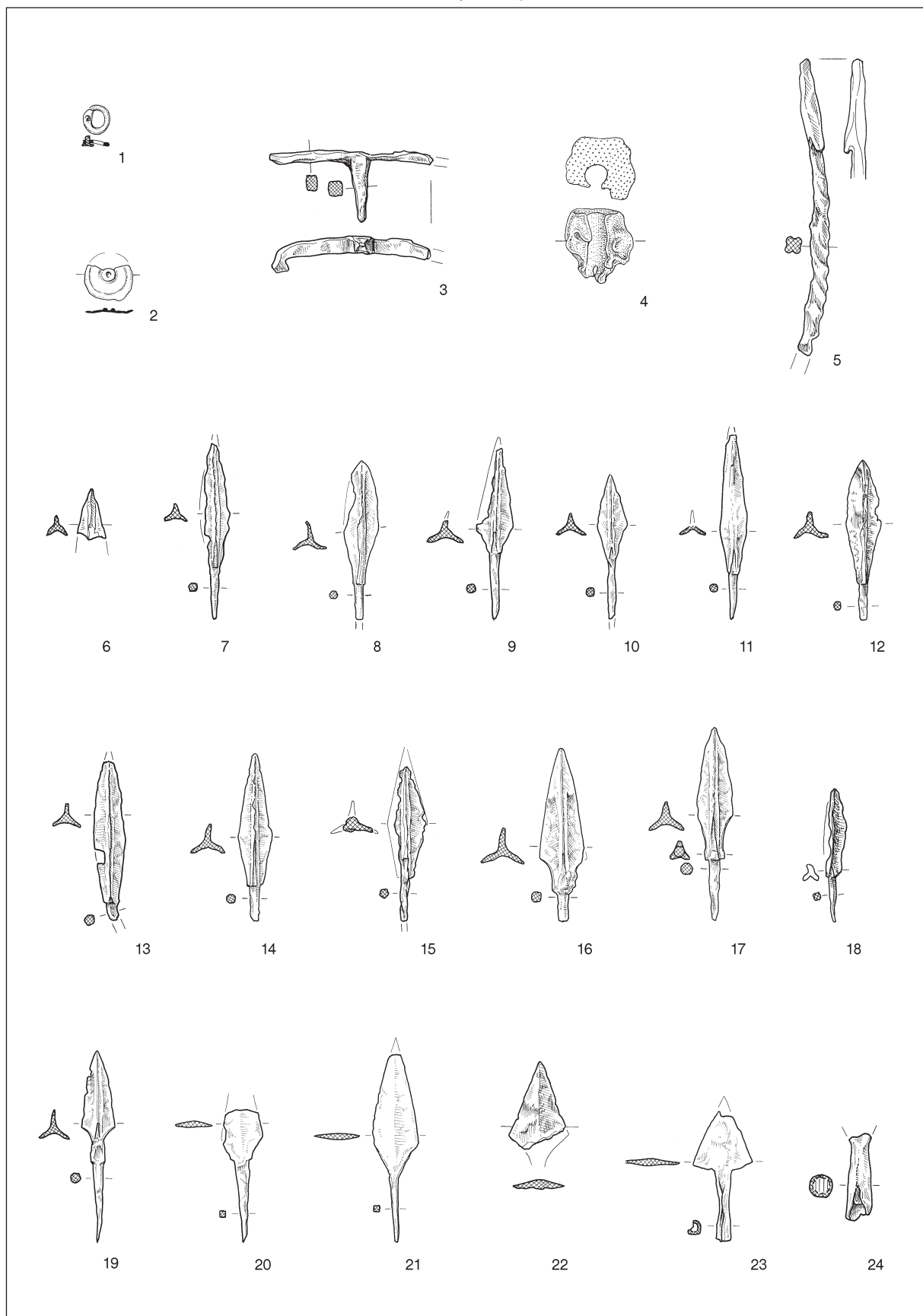

T. 9: Tonovcov grad, stavba 1. 1 bron, železo; 2 bron; 3,5–24 železo; 4 svinec. M. = 1:2.

Pl. 9: Tonovcov grad, building 1. 1 bronzes, iron; 2 bronzes; 3,5–24 iron; 4 lead. Scale = 1:2.

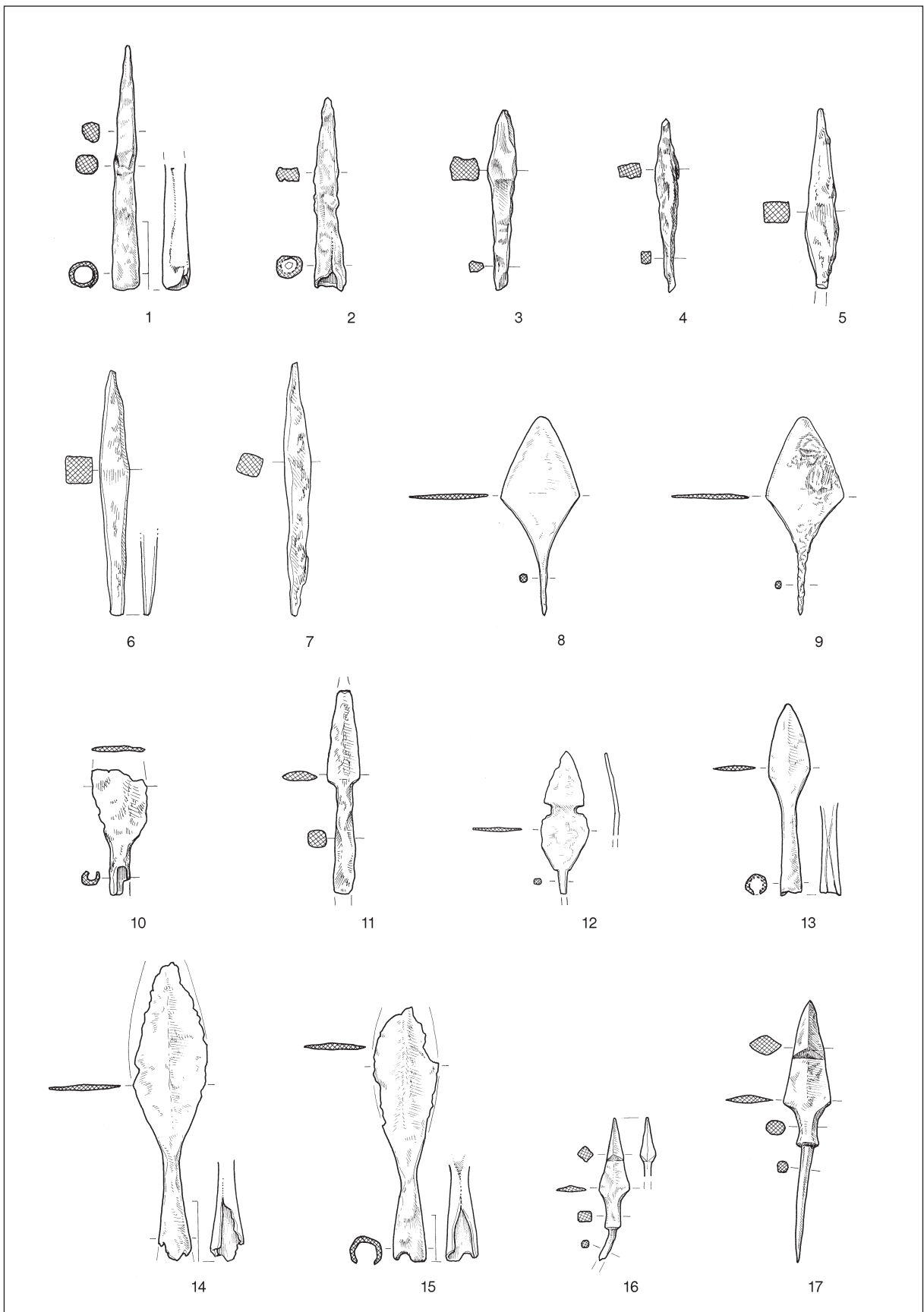

T. 10: Tonovcov grad, stavba 1. Vse železo. M. = 1:2.  
 Pl. 10: Tonovcov grad, building 1. All iron. Scale = 1:2.

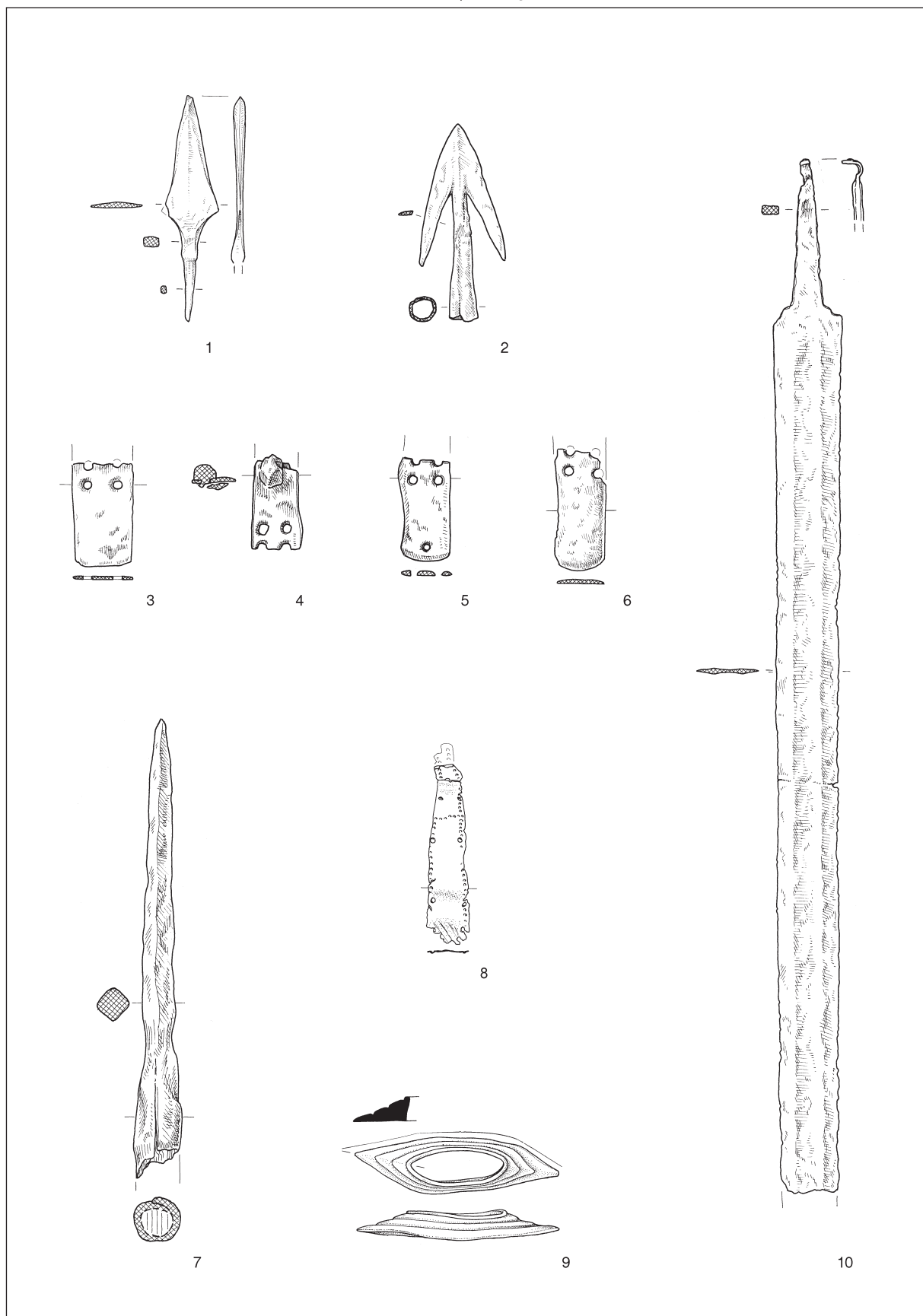

*T. 11:* Tonovcov grad, 1-9 stavba 1, 10 širše območje stavbe 1. 1-7, 10 železo; 8-9 bron. M. 1-9 = 1:2; 10 = 1:3.

*Pl. 11:* Tonovcov grad, 1-9 building 1, 10 wider area of building 1. 1-7, 10 iron; 8-9 bronze. Scale 1-9 = 1:2; 10 = 1:3.

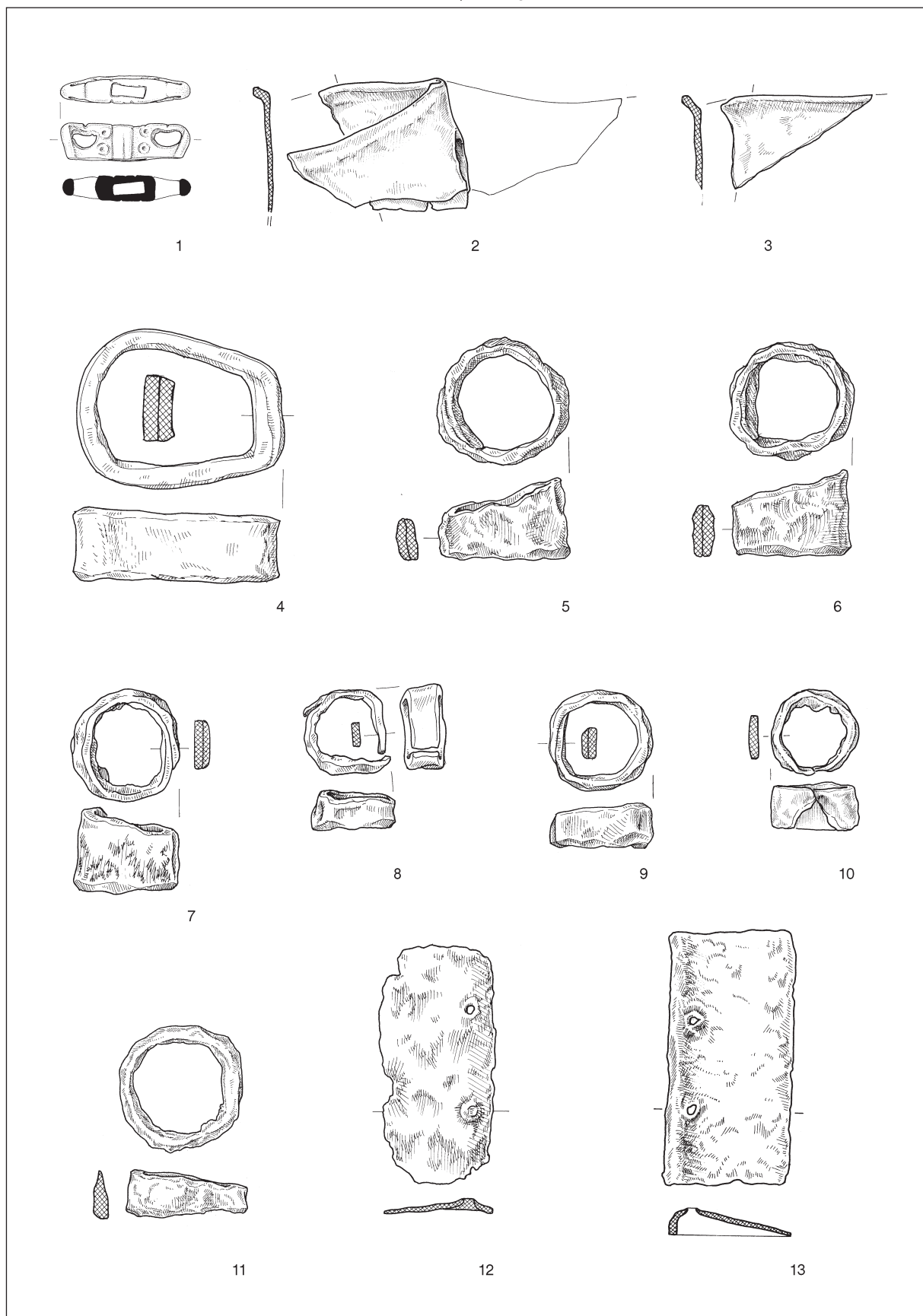

T. 12: Tonovcov grad, stavba 1. 1 bron; 2-13 železo. M. = 1:2.

Pl. 12: Tonovcov grad, building 1. 1 bronze; 2-13 iron. Scale = 1:2.

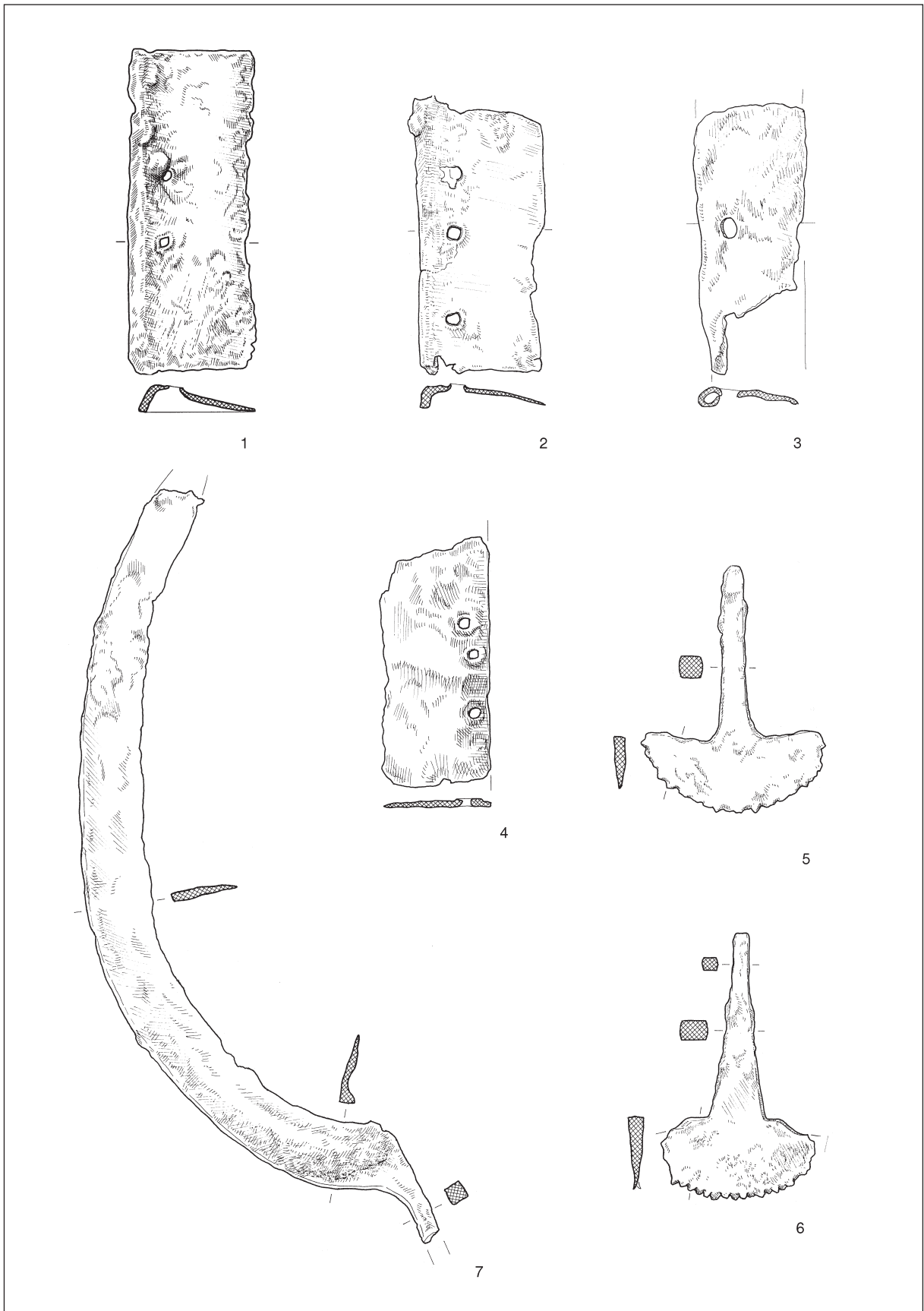

*T. 13:* Tonovcov grad, stavba 1. Vse železo. M. 1–6 = 1:2; 7 = 1:3.

*Pl. 13:* Tonovcov grad, building 1. All iron. Scale 1-6 = 1:2; 7 = 1:3.

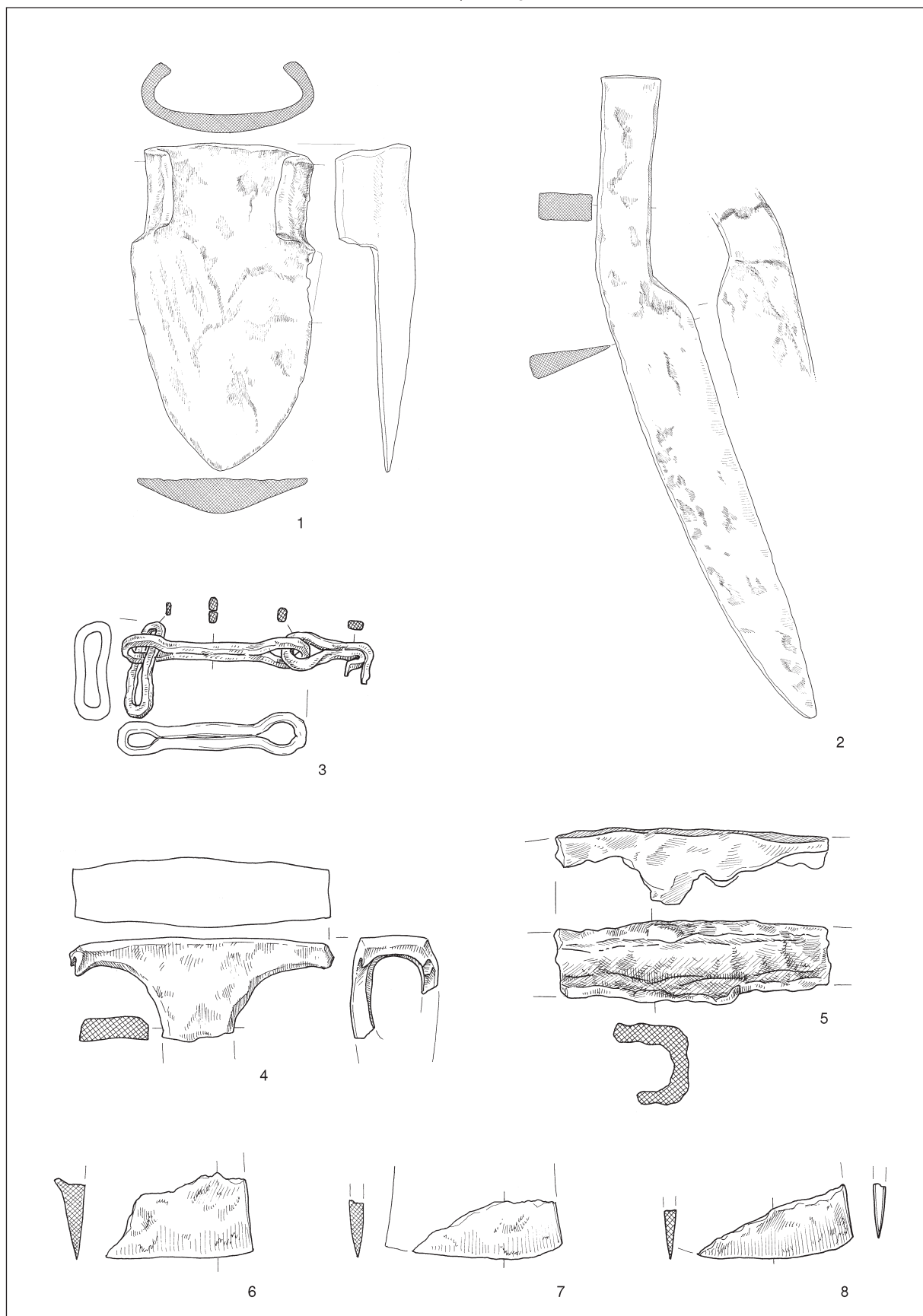

T. 14: Tonovcov grad, stavba 1. Vse železo. M. 1-2 = 1:5; 3-8 = 1:2.

Pl. 14: Tonovcov grad, building 1. All iron. Scale 1-2 = 1:5; 3-8 = 1:2.



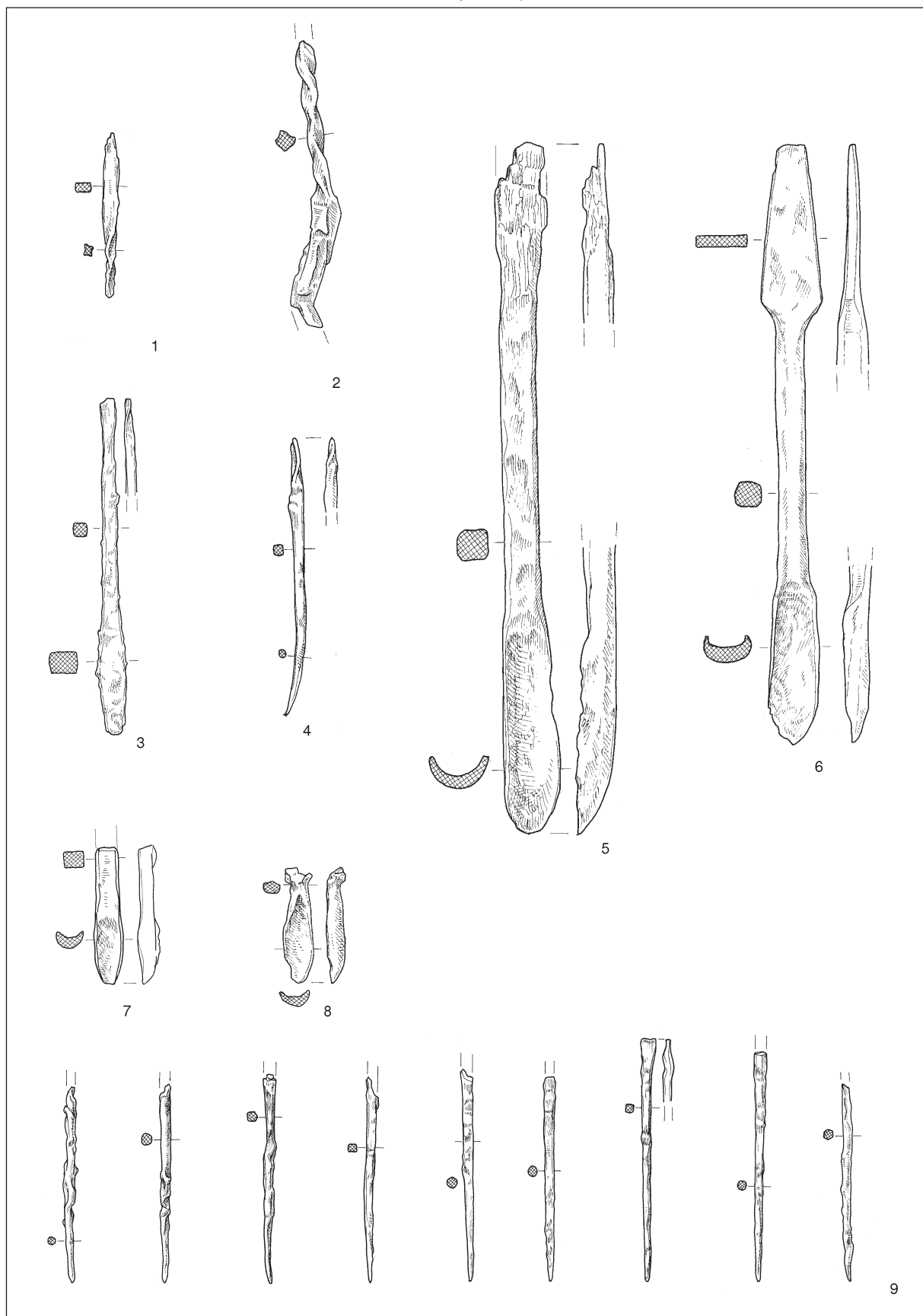

T. 15: Tonovcov grad, stavba 1. Vse železo. M. = 1:2.  
 Pl. 15: Tonovcov grad, building 1. All iron. Scale = 1:2.

TABLE / PLATES

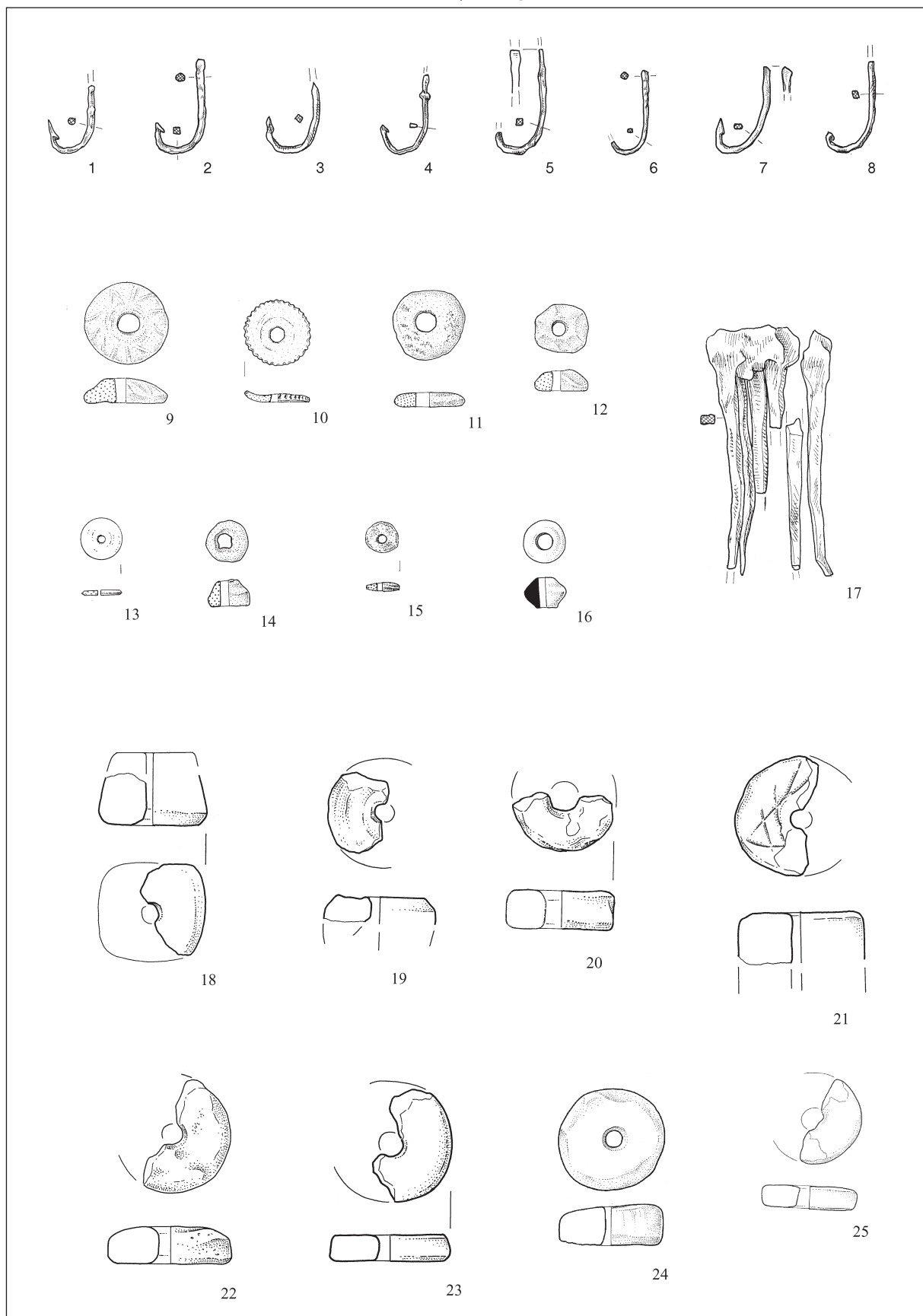

T. 16: Tonovcov grad, stavba 1. 1-8,17 železo; 9-15 svinec; 16 bron; 18-25 keramika. M. = 1:2.  
 Pl. 16: Tonovcov grad, building 1. 1-8,17 iron; 9-15 lead; 16 bronze; 18-25 pottery. Scale = 1:2.

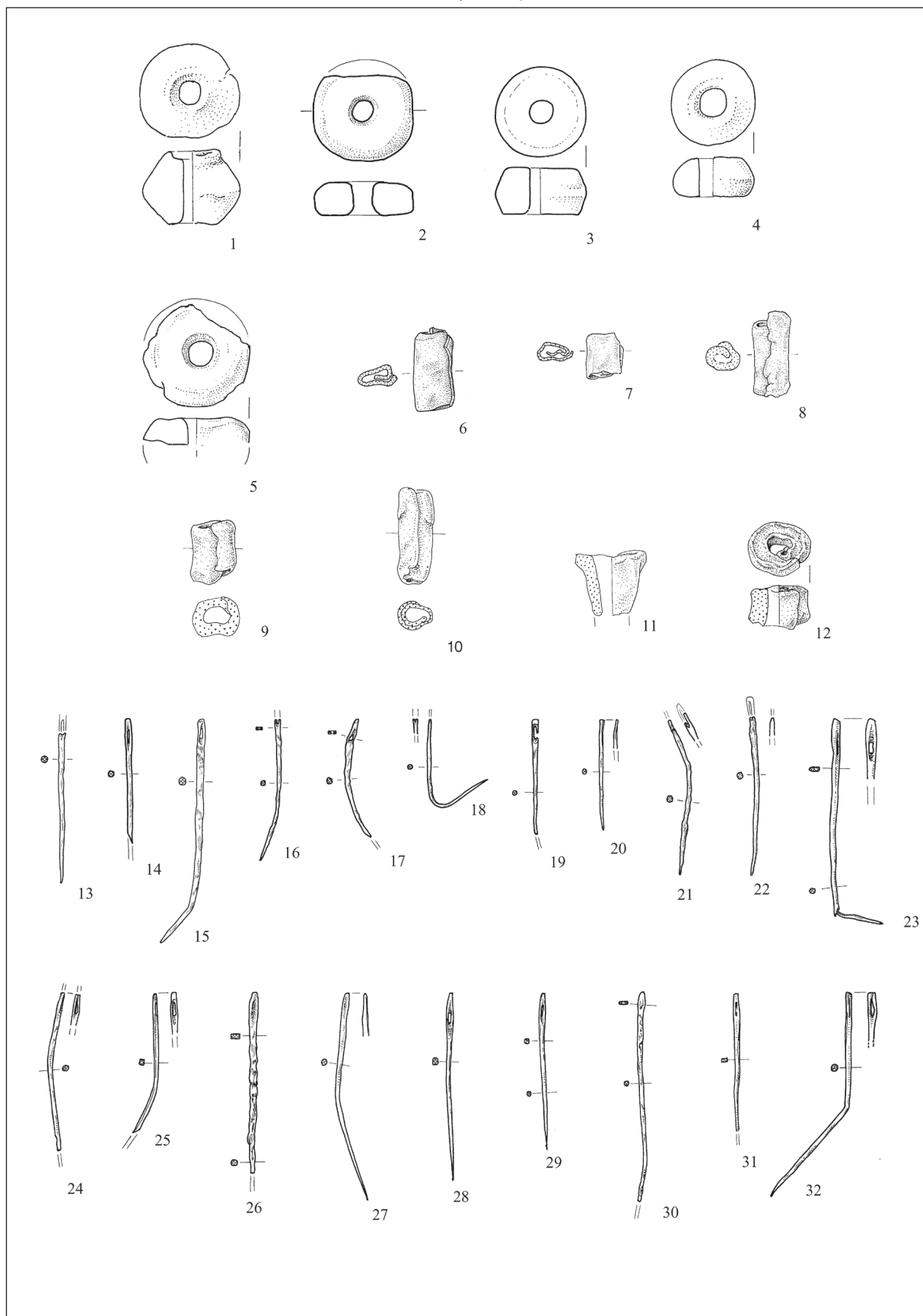

T. 17: Tonovcov grad, stavba 1. 1-5 keramika; 6-12 svinec; 13-32 železo. M. = 1:2.

Pl. 17: Tonovcov grad, building 1. 1-5 pottery; 6-12 lead; 13-32 iron. Scale = 1:2.

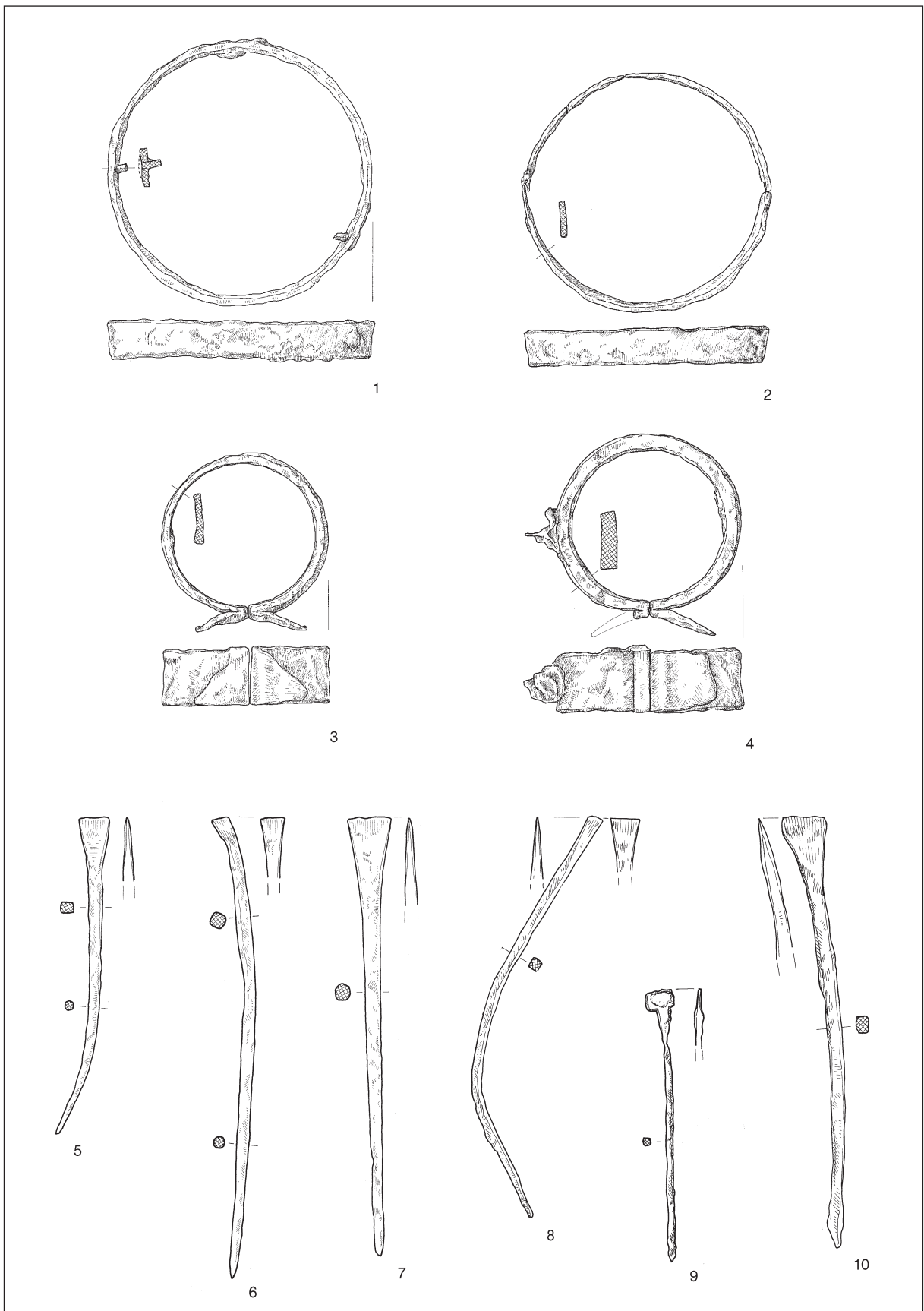

*T. 18:* Tonovcov grad, stavba 1. Vse železo. M. 1-4 = 1:4; 5-10 = 1:2.

*Pl. 18:* Tonovcov grad, building 1. All iron. Scale 1-4 = 1:4; 5-10 = 1:2.

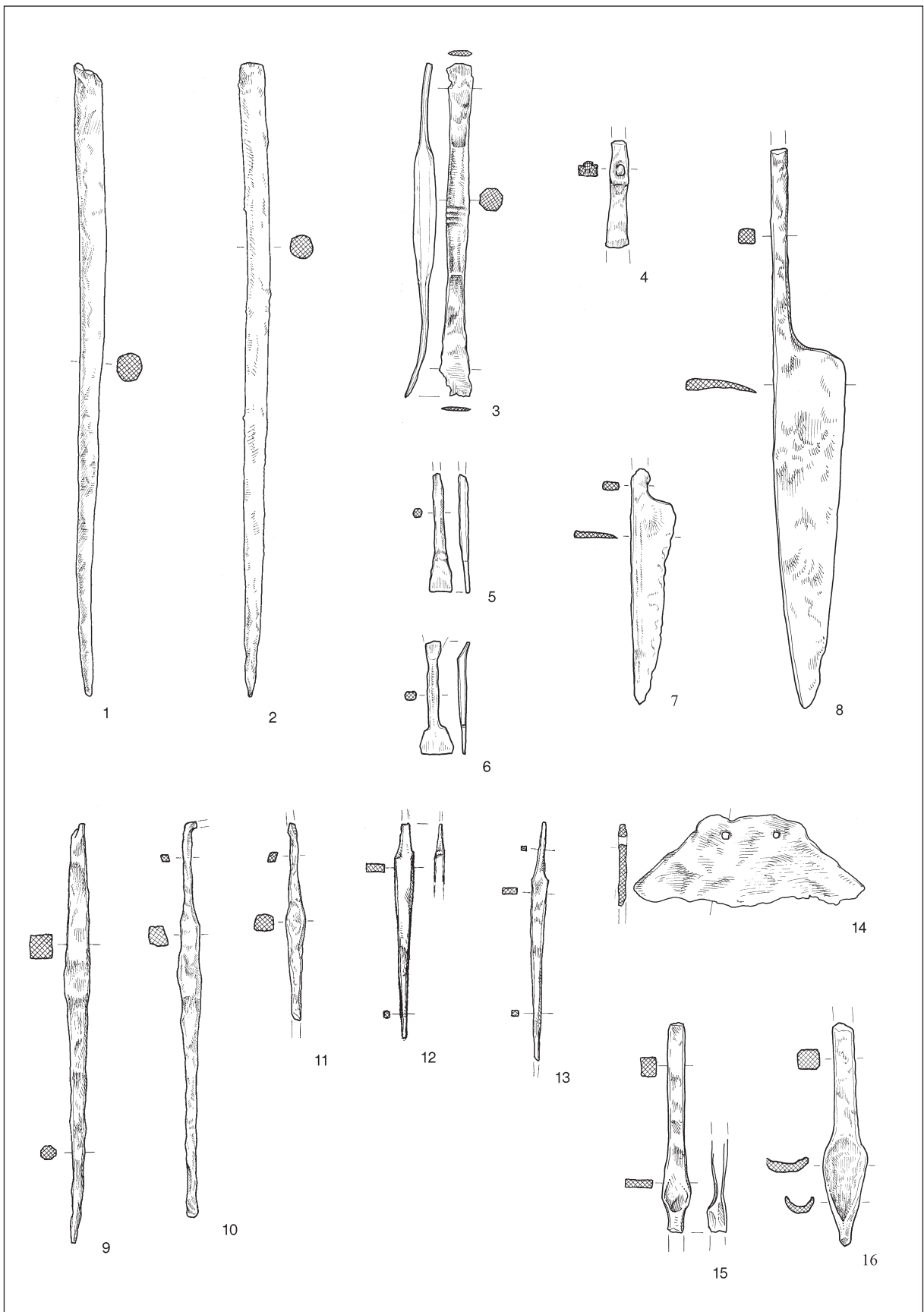

T. 19: Tonovcov grad, stavba 1. Vse železo. M. = 1:2.  
 Pl. 19: Tonovcov grad, building 1. All iron. Scale = 1:2.

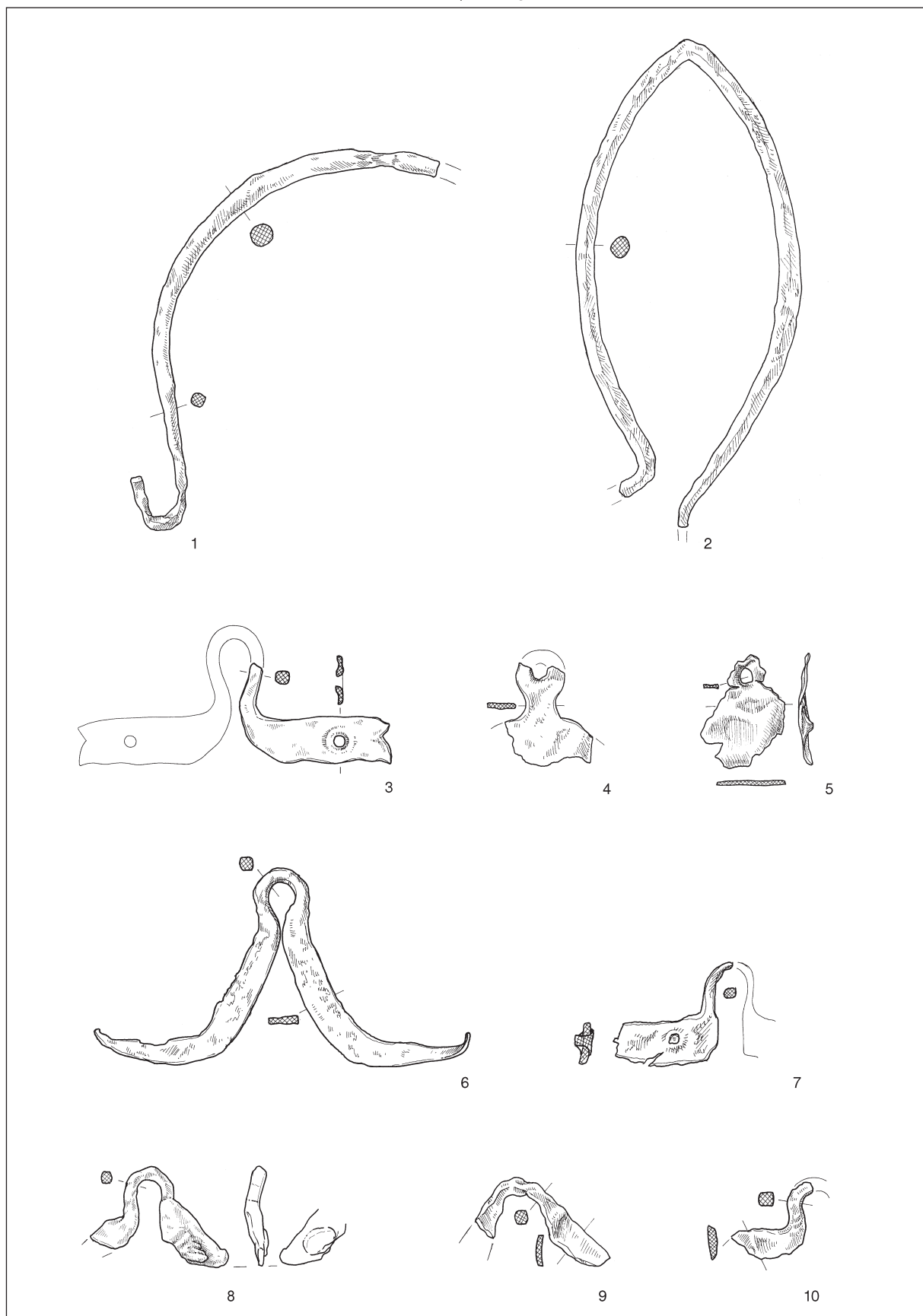

T. 20: Tonovcov grad, stavba 1. Vse železo. M. = 1:2.  
 Pl. 20: Tonovcov grad, building 1. All iron. Scale = 1:2.

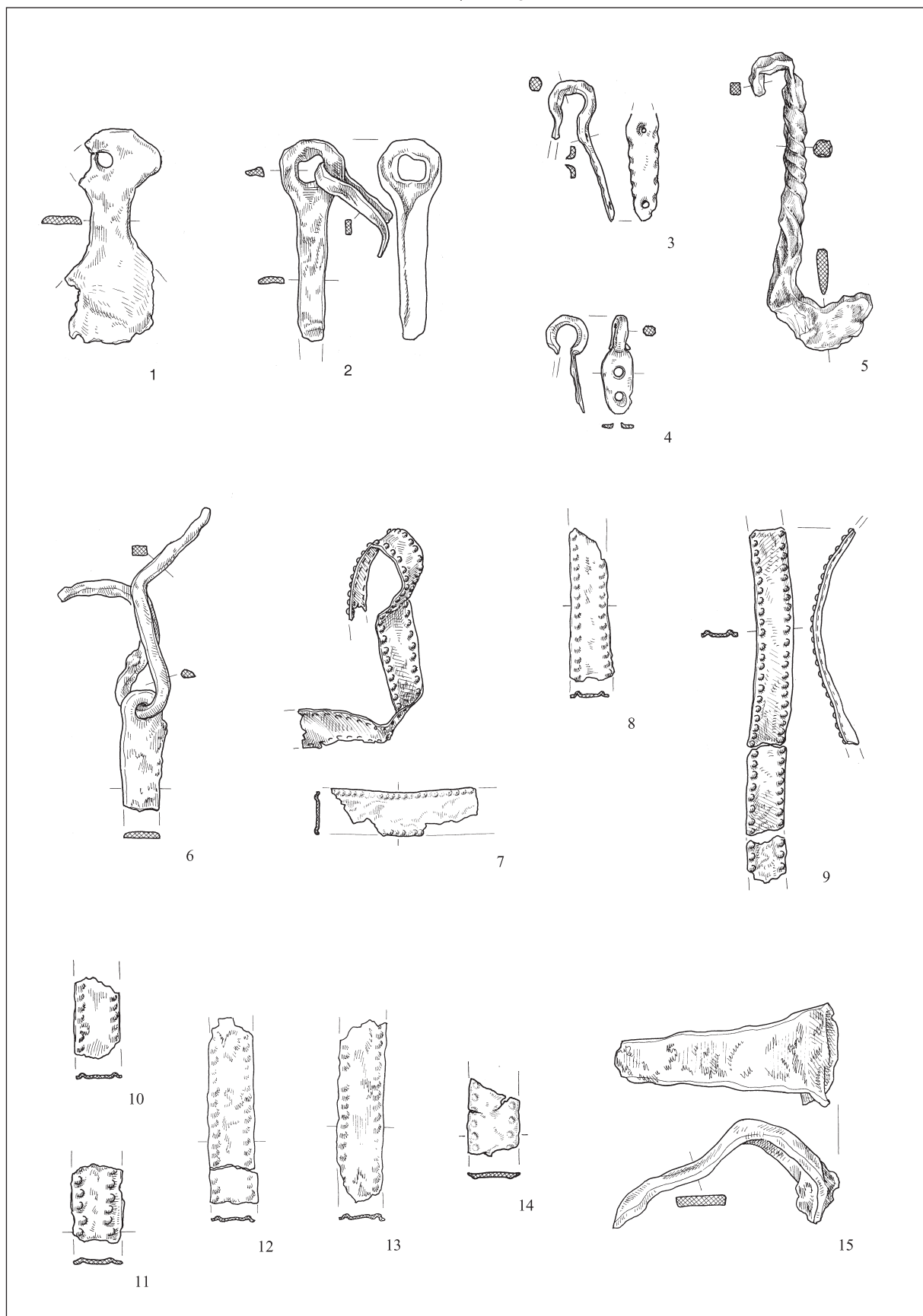

T. 21: Tonovcov grad, stavba 1. Vše železo. M. = 1:2.  
 Pl. 21: Tonovcov grad, building 1. All iron. Scale = 1:2.

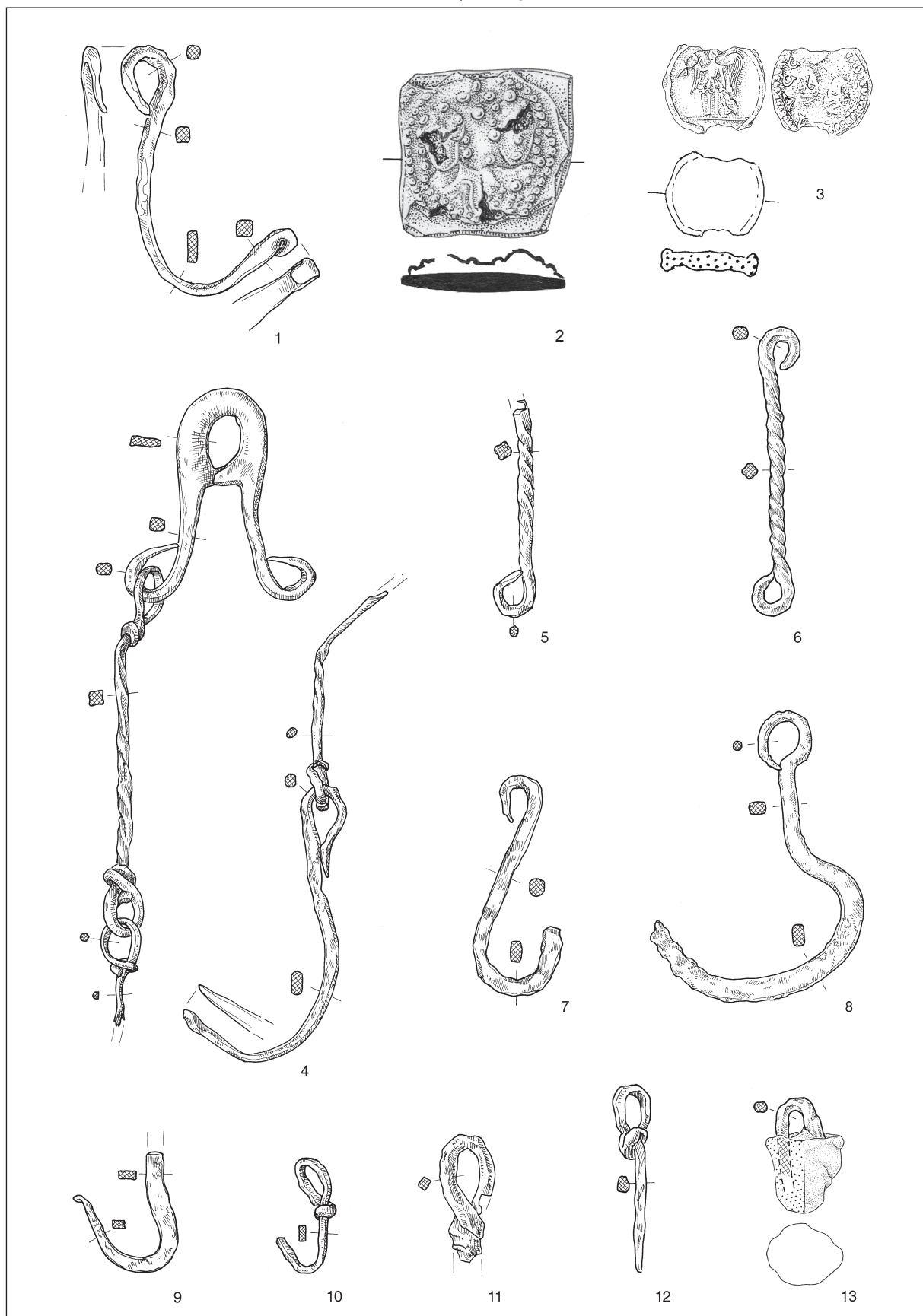

T. 22: Tonovcov grad, stavba 1. 1,4-12 železo; 2 bron; 3 svinec; 13 svinec, železo. M. 1,4-13= 1:2, 2-3 = 2:1.

Pl. 22: Tonovcov grad, building 1. 1,4-12 iron; 2 bronze; 3 lead; 13 lead, iron. Scale 1,4-13= 1:2, 2-3 = 2:1.



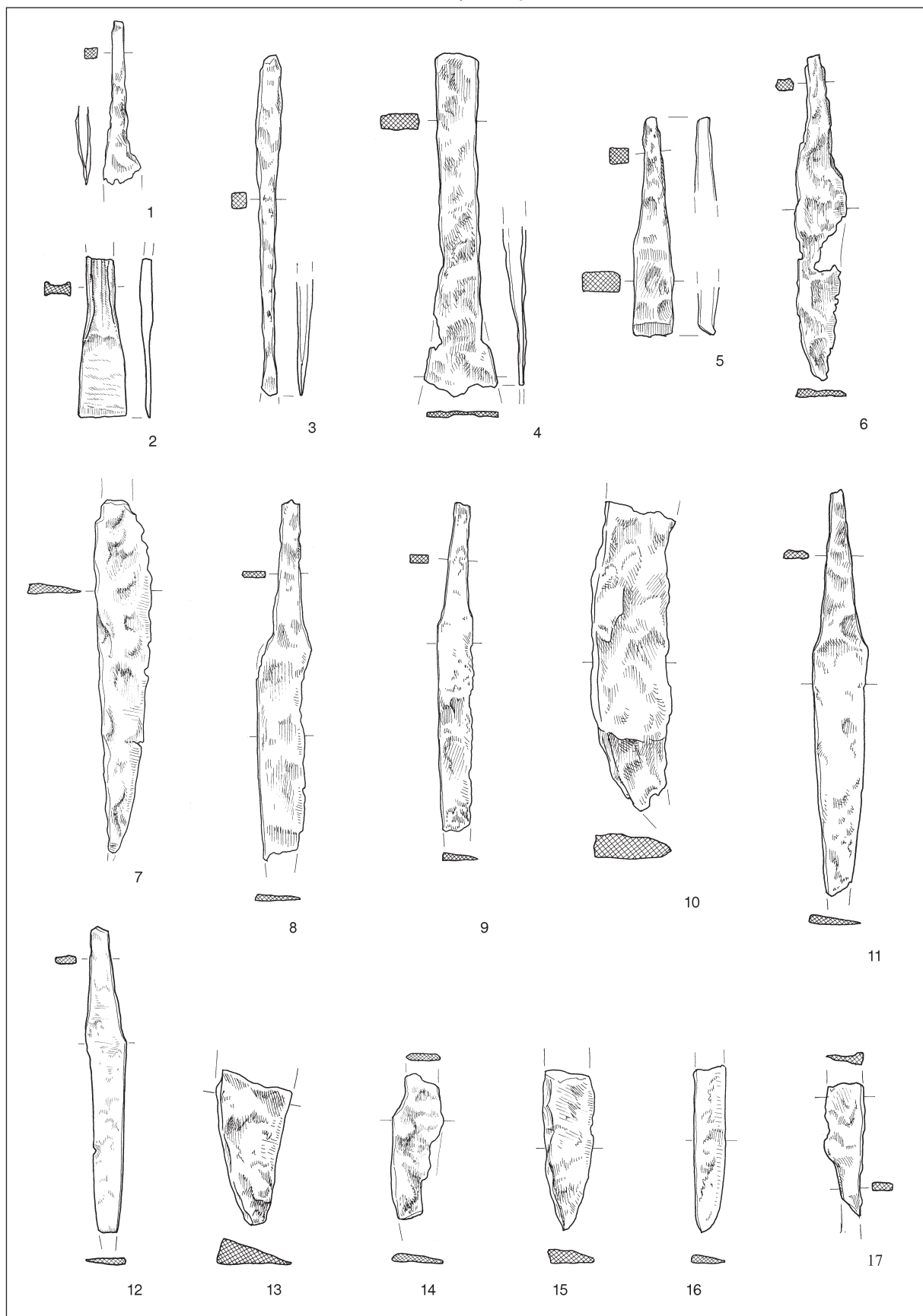

T. 23: Tonovcov grad, stavba 1. Vse železo. M. = 1:2.  
 Pl. 23: Tonovcov grad, building 1. All iron. Scale = 1:2.

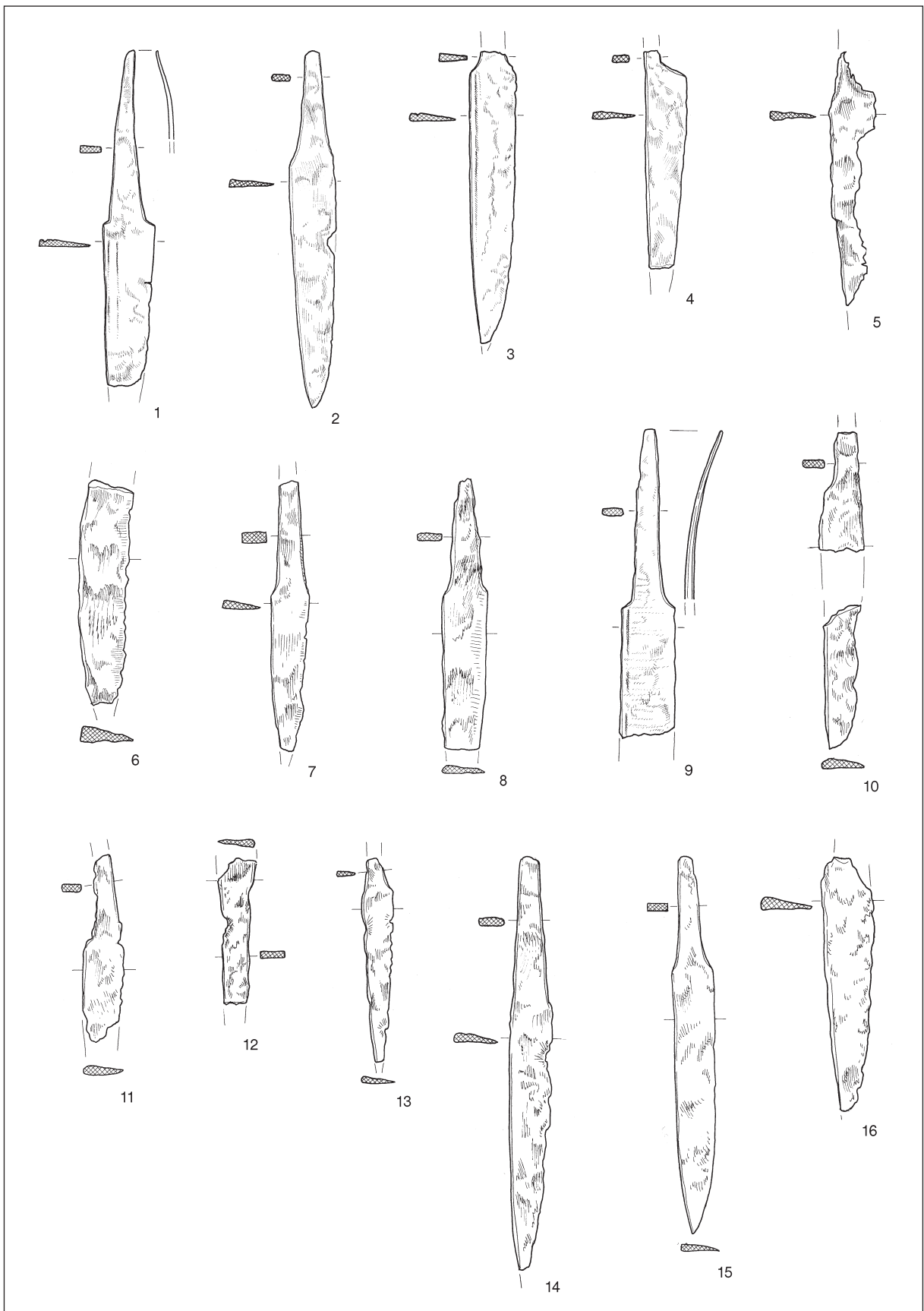

T. 24: Tonovcov grad, stavba 1. Vse železo. M. = 1:2.  
 Pl. 24: Tonovcov grad, building 1. All iron. Scale = 1:2.

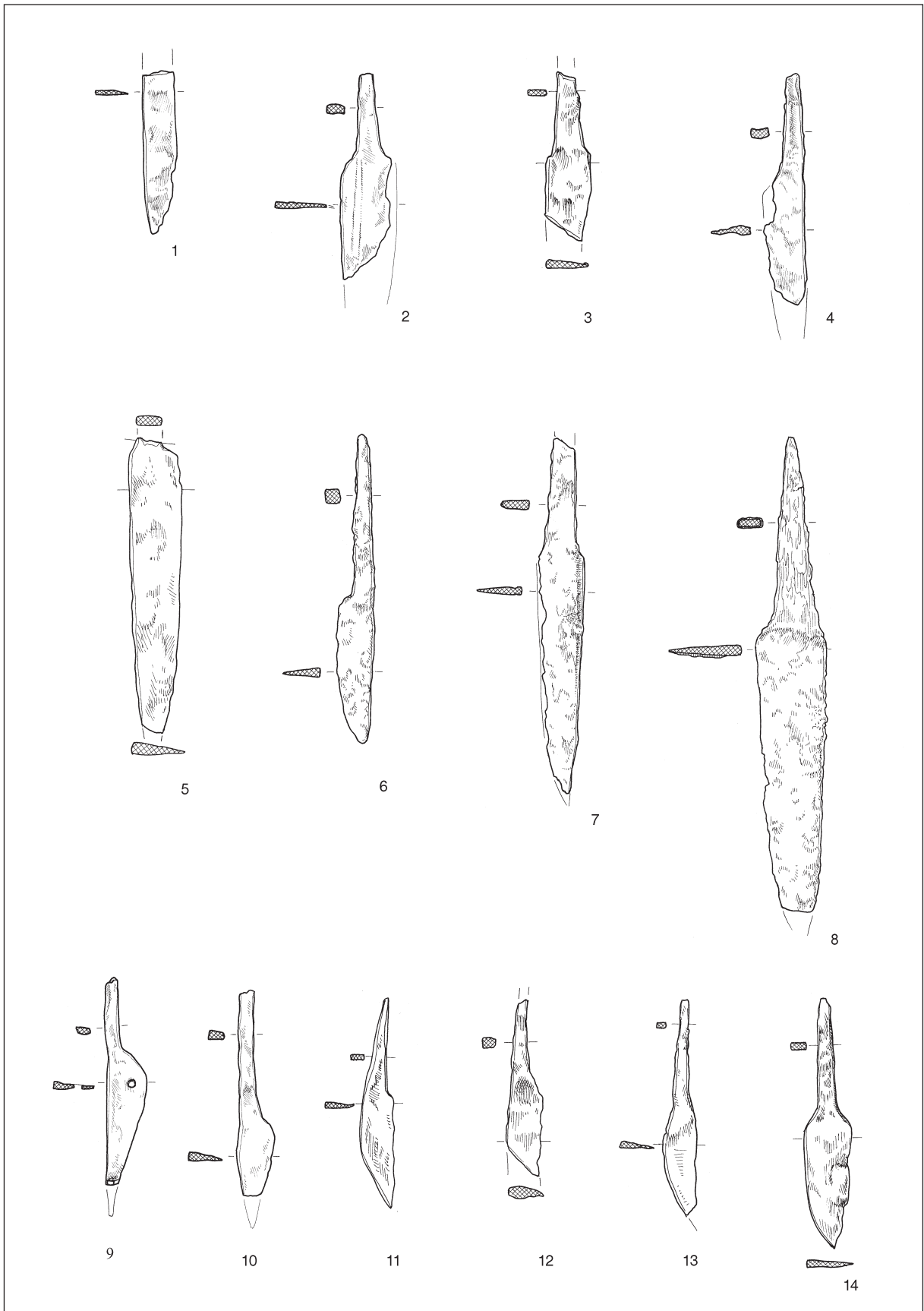

T. 25: Tonovcov grad, stavba 1. Vse železo. M. = 1:2.  
 Pl. 25: Tonovcov grad, building 1. All iron. Scale = 1:2.

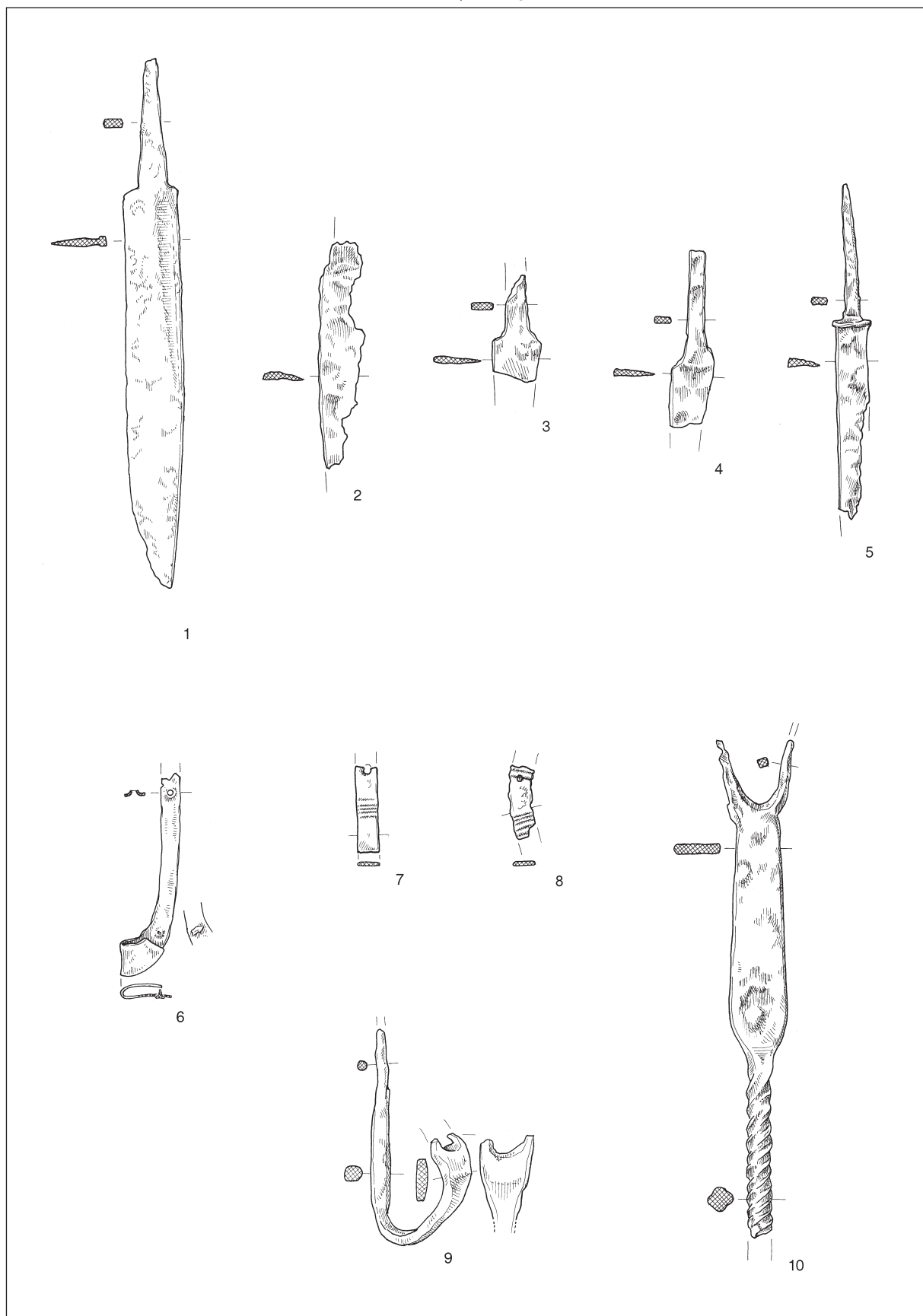

T. 26: Tonovcov grad, stavba 1. Vse železo. M. = 1:2.  
 Pl. 26: Tonovcov grad, building 1. All iron. Scale = 1:2.

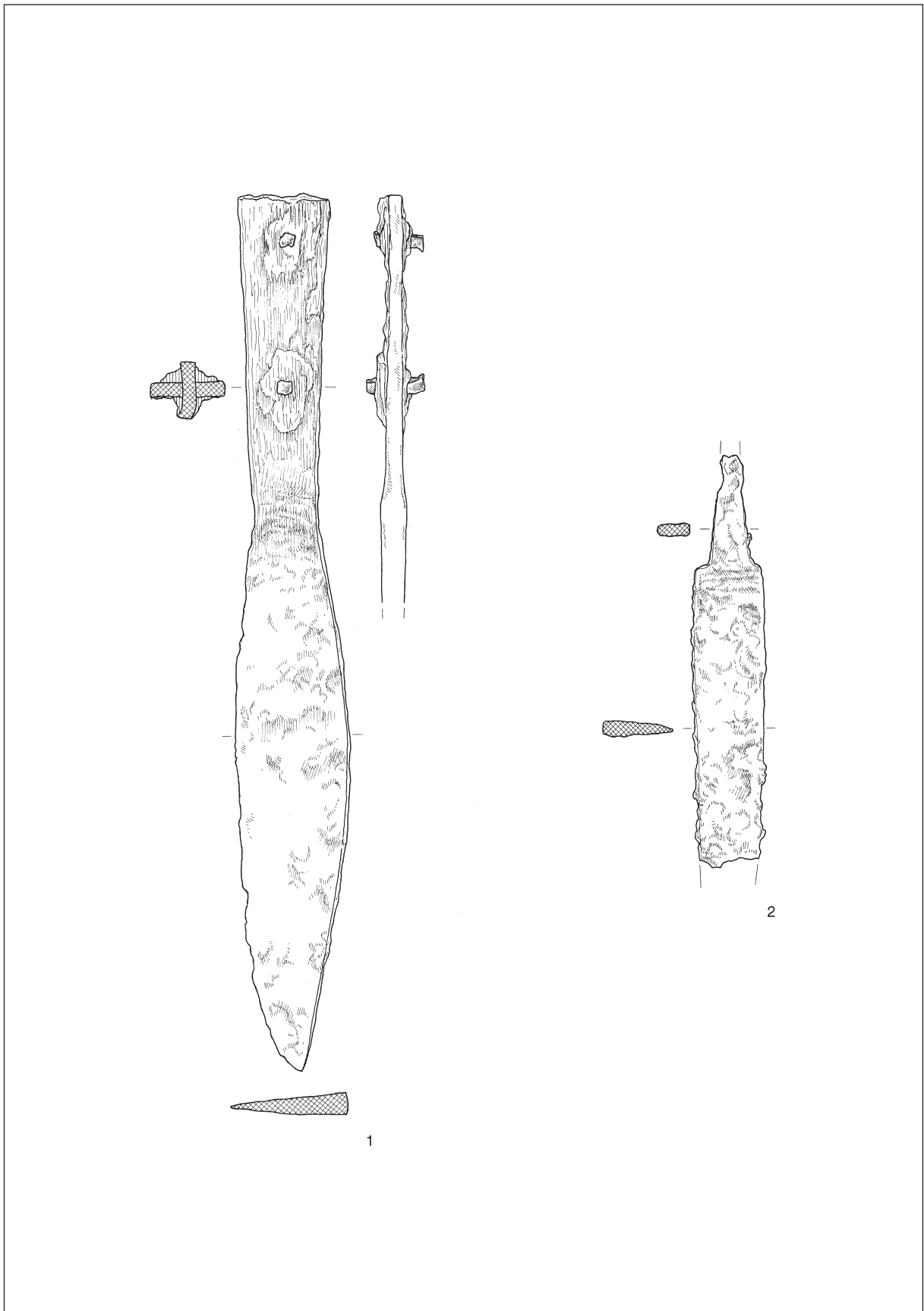

T. 27: Tonovcov grad, stavba 1. Vse železo. M. = 1:2.

Pl. 27: Tonovcov grad, building 1. All iron. Scale = 1:2.

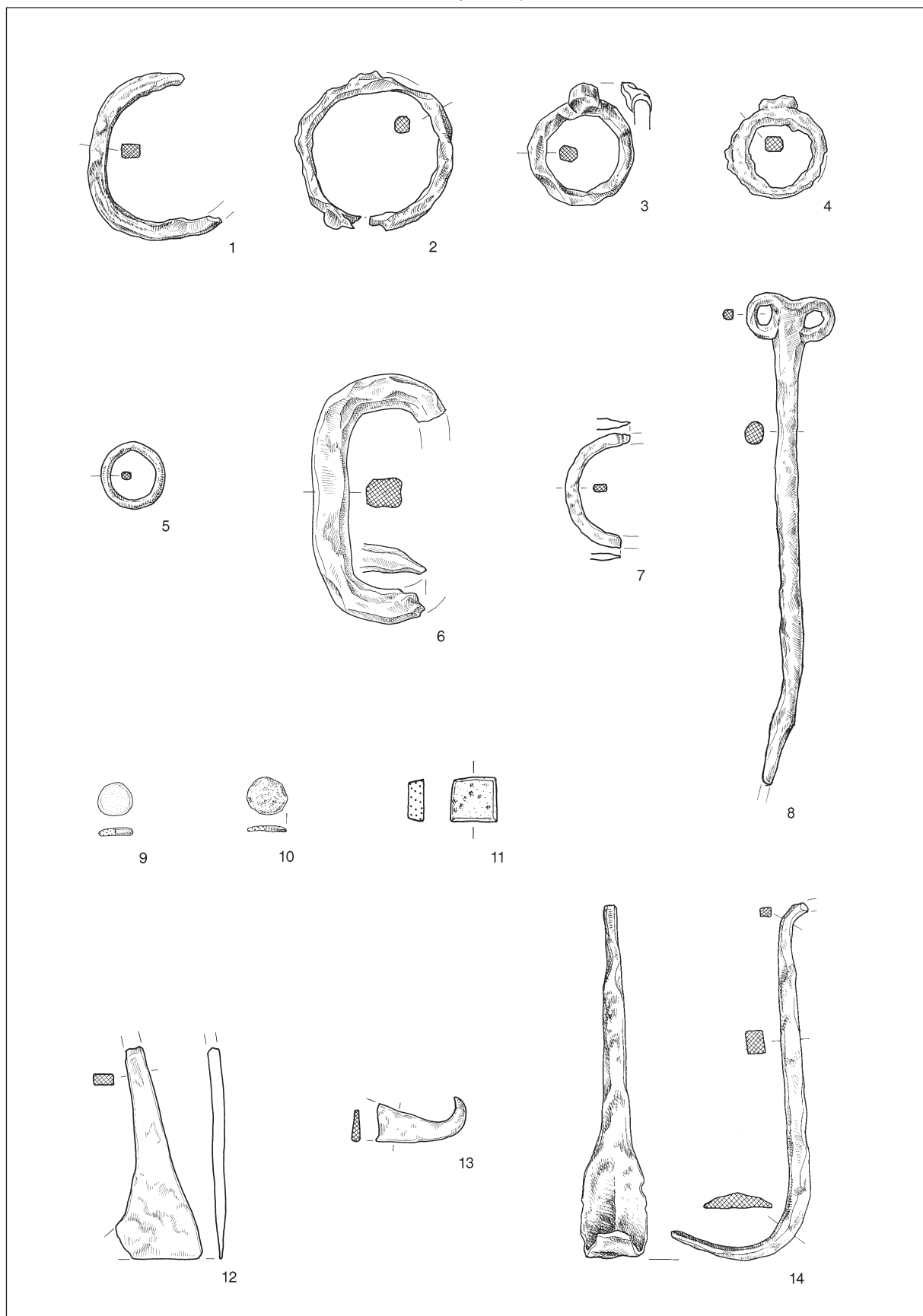

T. 28: Tonovcov grad, stavba 1. 1-8,12-14 železo; 9-11 svinec. M. = 1:2.  
 Pl. 28: Tonovcov grad, building 1. 1-8,12-14 iron; 9-11 lead. Scale = 1:2.

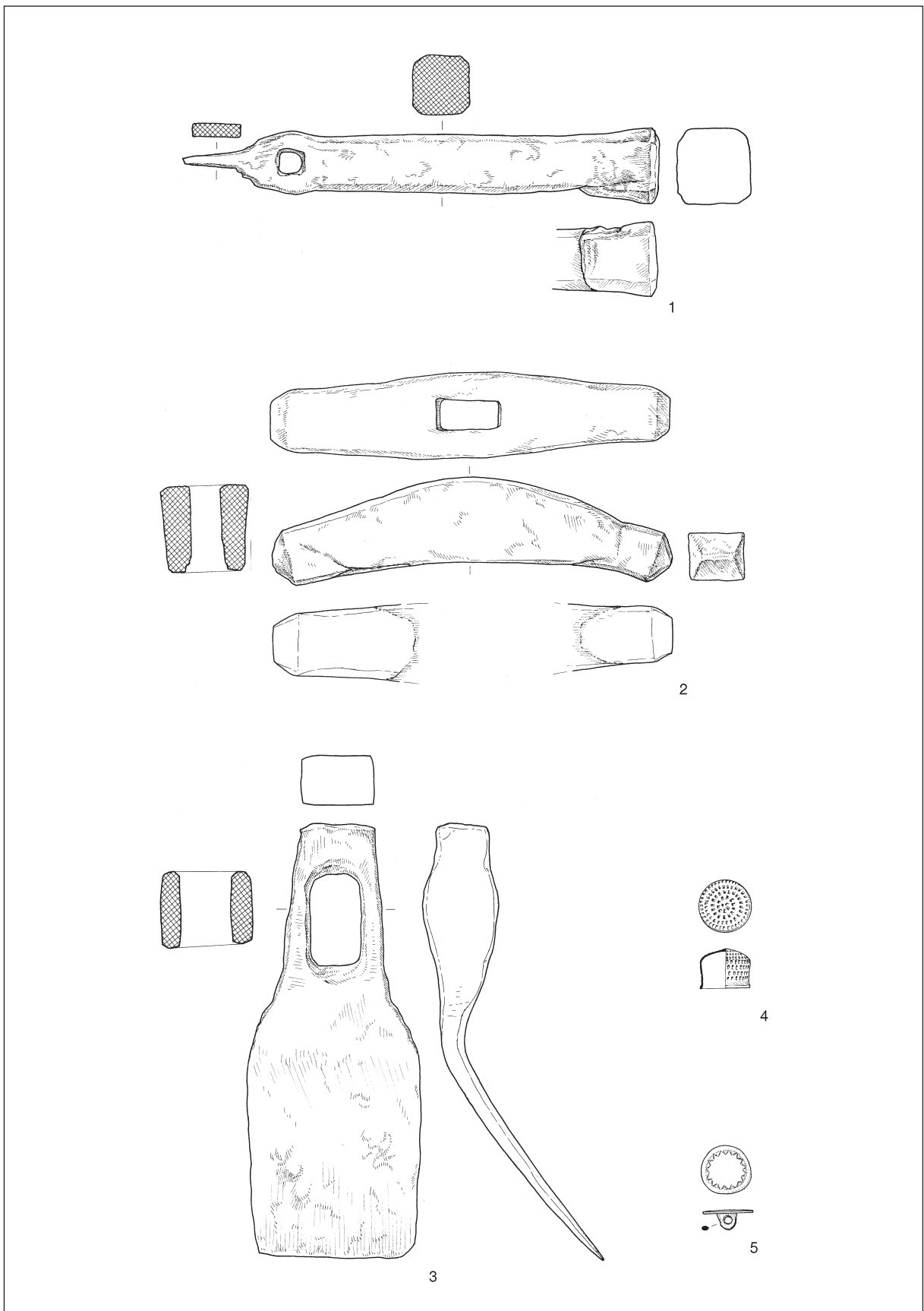

T. 29: Tonovcov grad, stavba 1. 1-3 železo; 4-5 bron. M. = 1:2.  
 Pl. 29: Tonovcov grad, building 1. 1-3 iron; 4-5 bronze. Scale = 1:2.

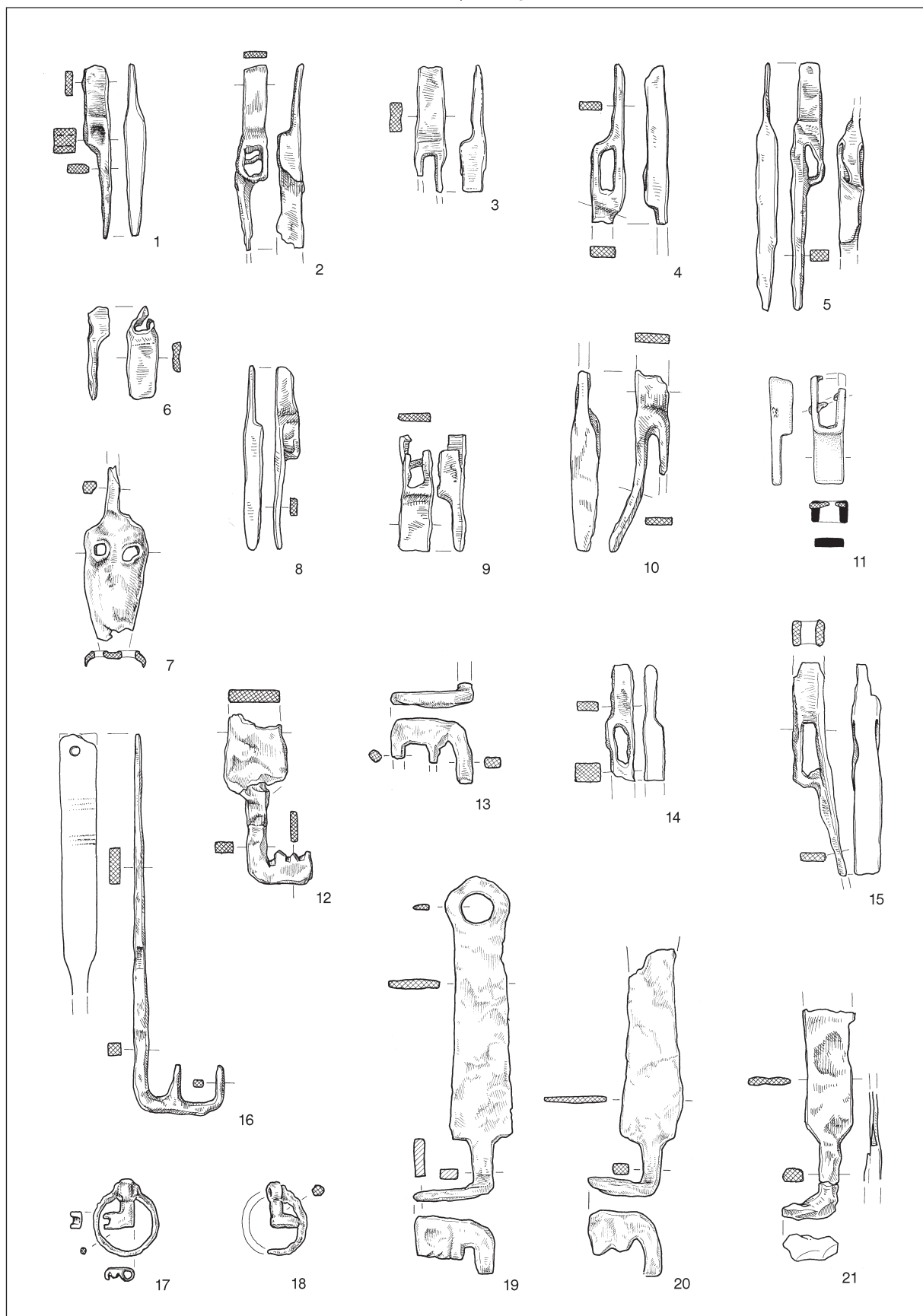

T. 30: Tonovcov grad, stavba 1. 1-10,12-21 železo; 11 bron, železo. M. = 1:2.

Pl. 30: Tonovcov grad, building 1. 1-10,12-21 iron; 11 bronze, iron. Scale = 1:2.



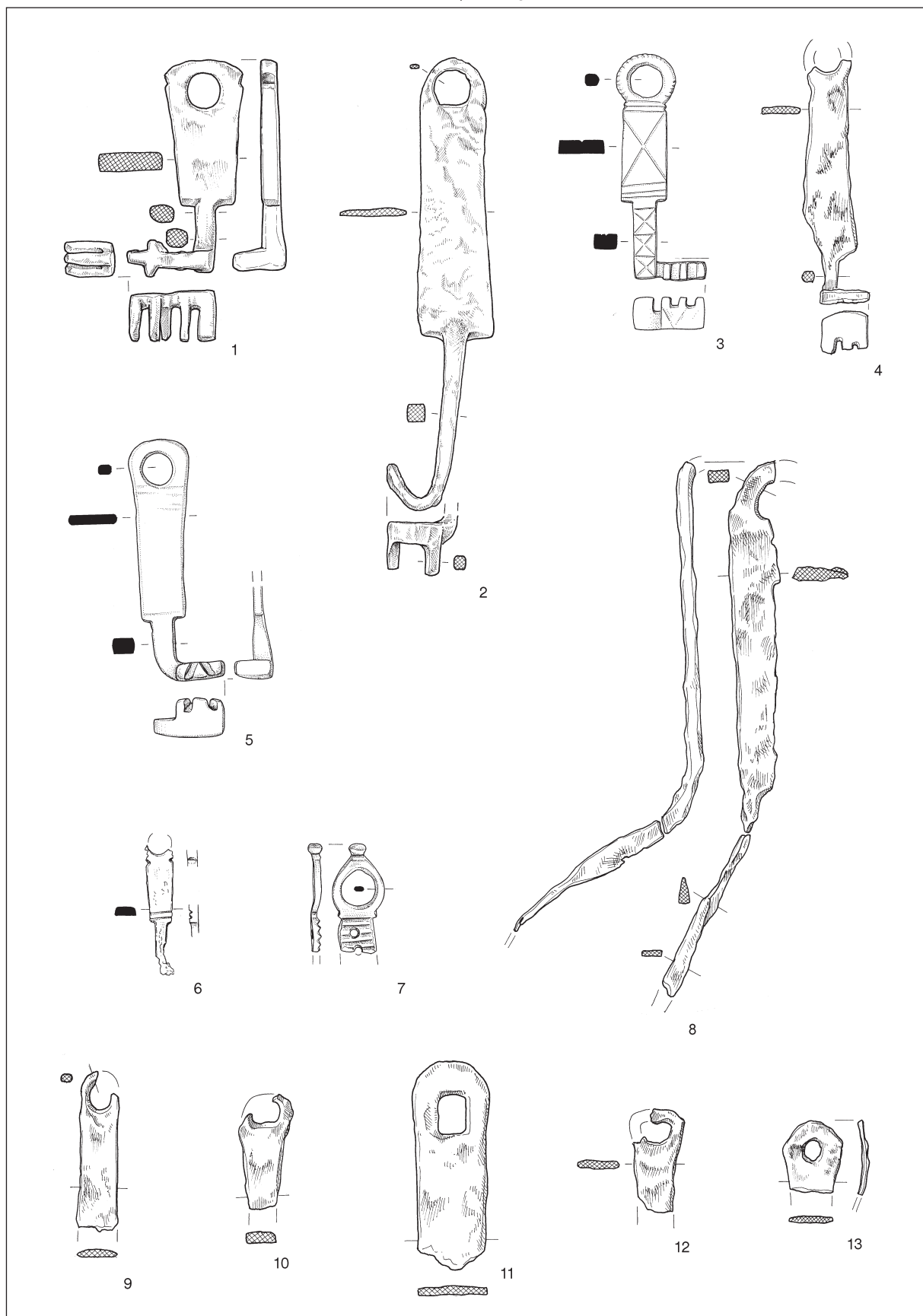

*T. 31:* Tonovcov grad, stavba 1. 1-2, 4,8-13 železo; 3,5-7 bron. M. = 1:2.

*Pl. 31:* Tonovcov grad, building 1. 1-2, 4,8-13 iron; 3,5-7 bronze. Scale = 1:2.

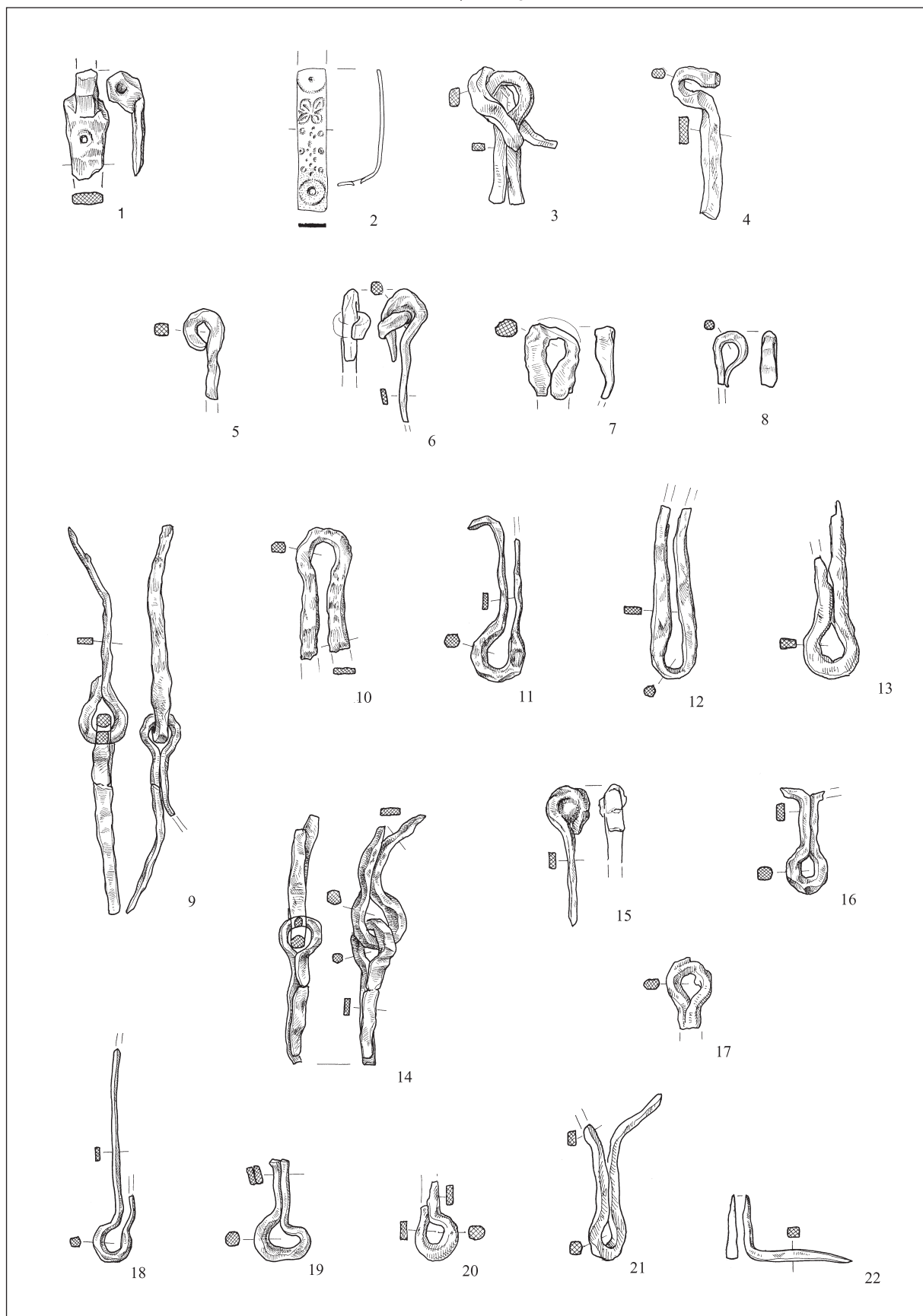

T. 32: Tonovcov grad, stavba 1. 1,3-22 železo; 2 bron. M. = 1:2.

Pl. 32: Tonovcov grad, building 1. 1,3-22 iron; 2 bronze. Scale = 1:2.

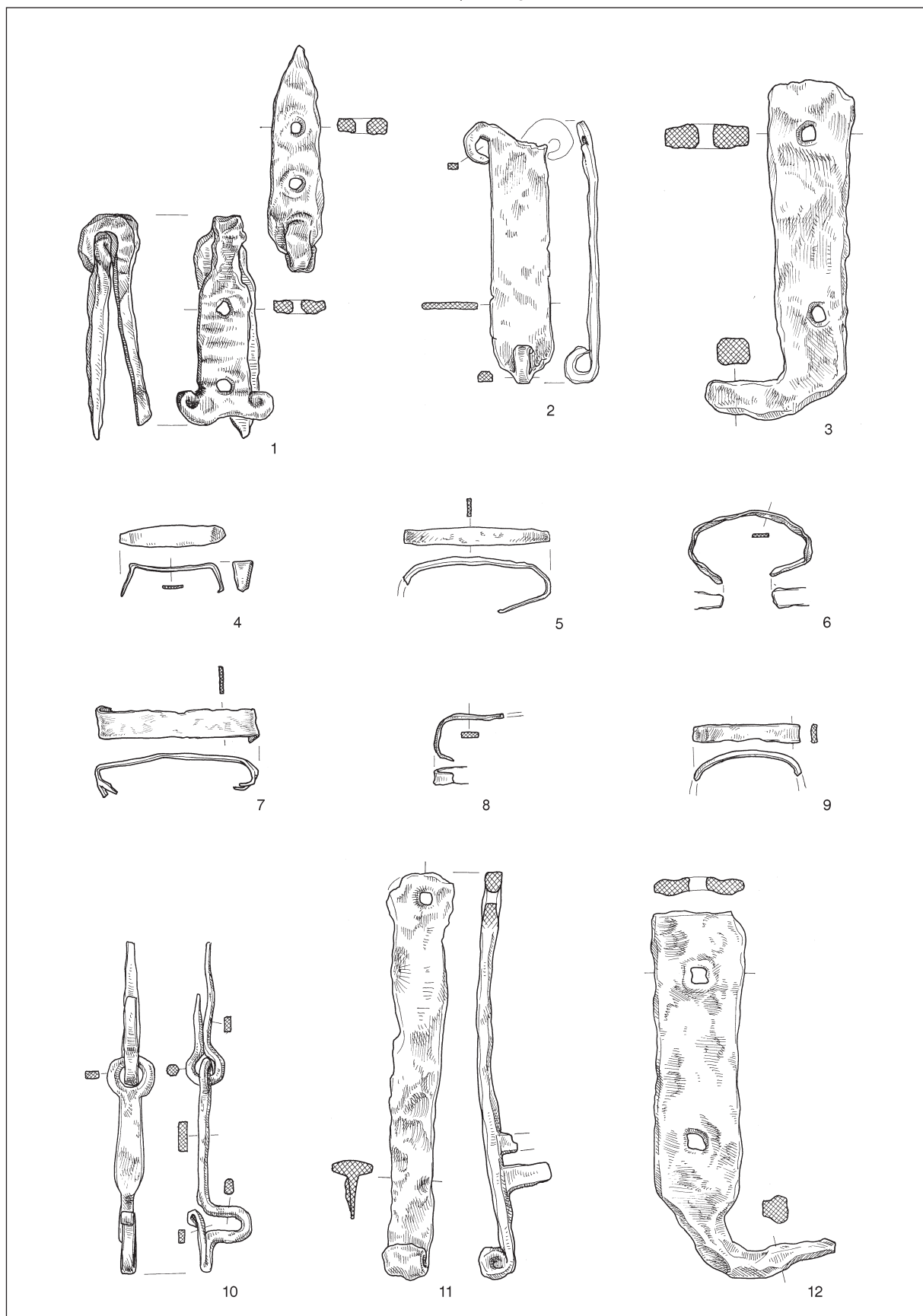

T. 33: Tonovcov grad, stavba 1. Vse železo. M. = 1:2.  
 Pl. 33: Tonovcov grad, building 1. All iron. Scale = 1:2.

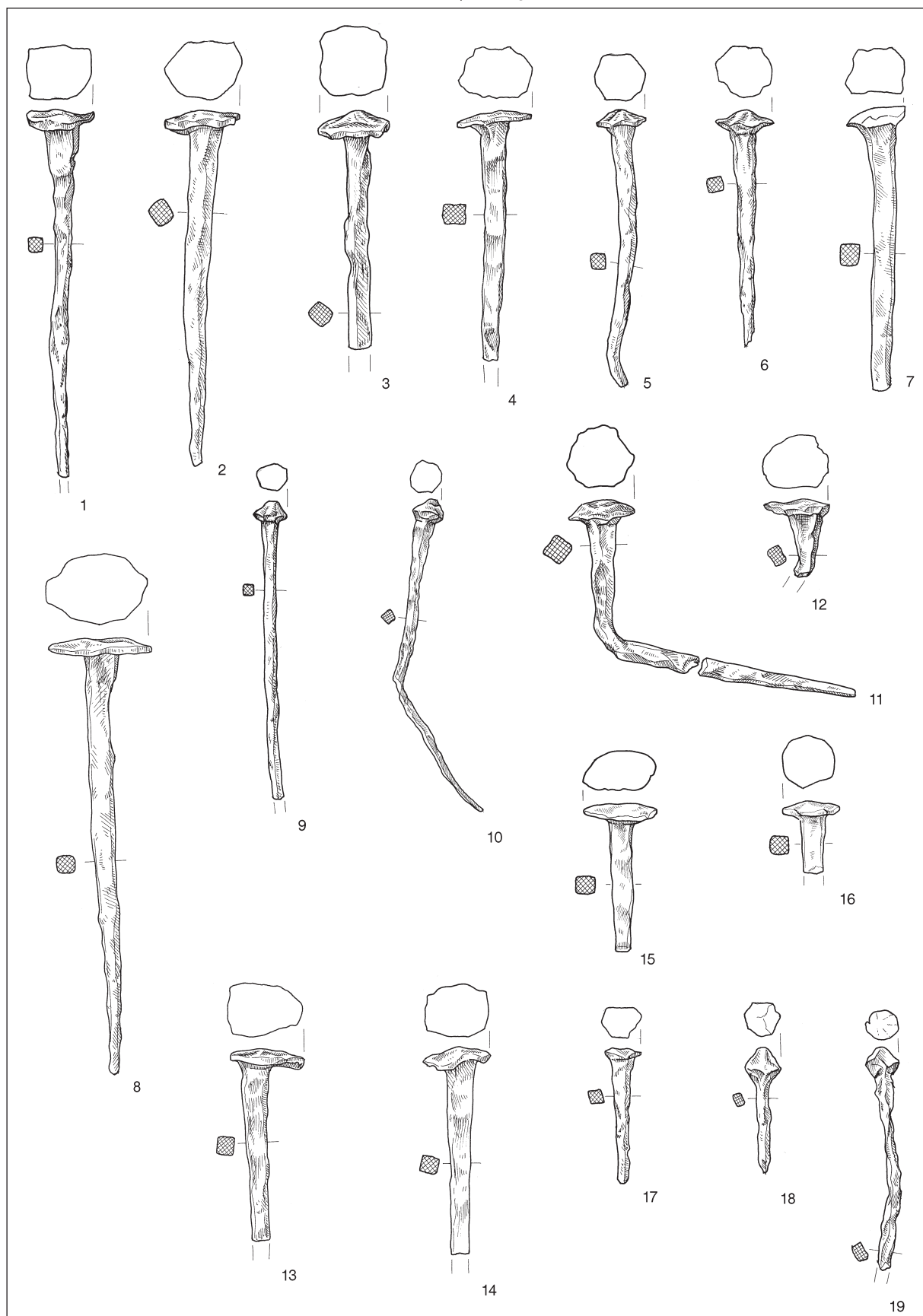

T. 34: Tonovcov grad, stavba 1. Vse železo. M. = 1:2.  
 Pl. 34: Tonovcov grad, building 1. All iron. Scale = 1:2.

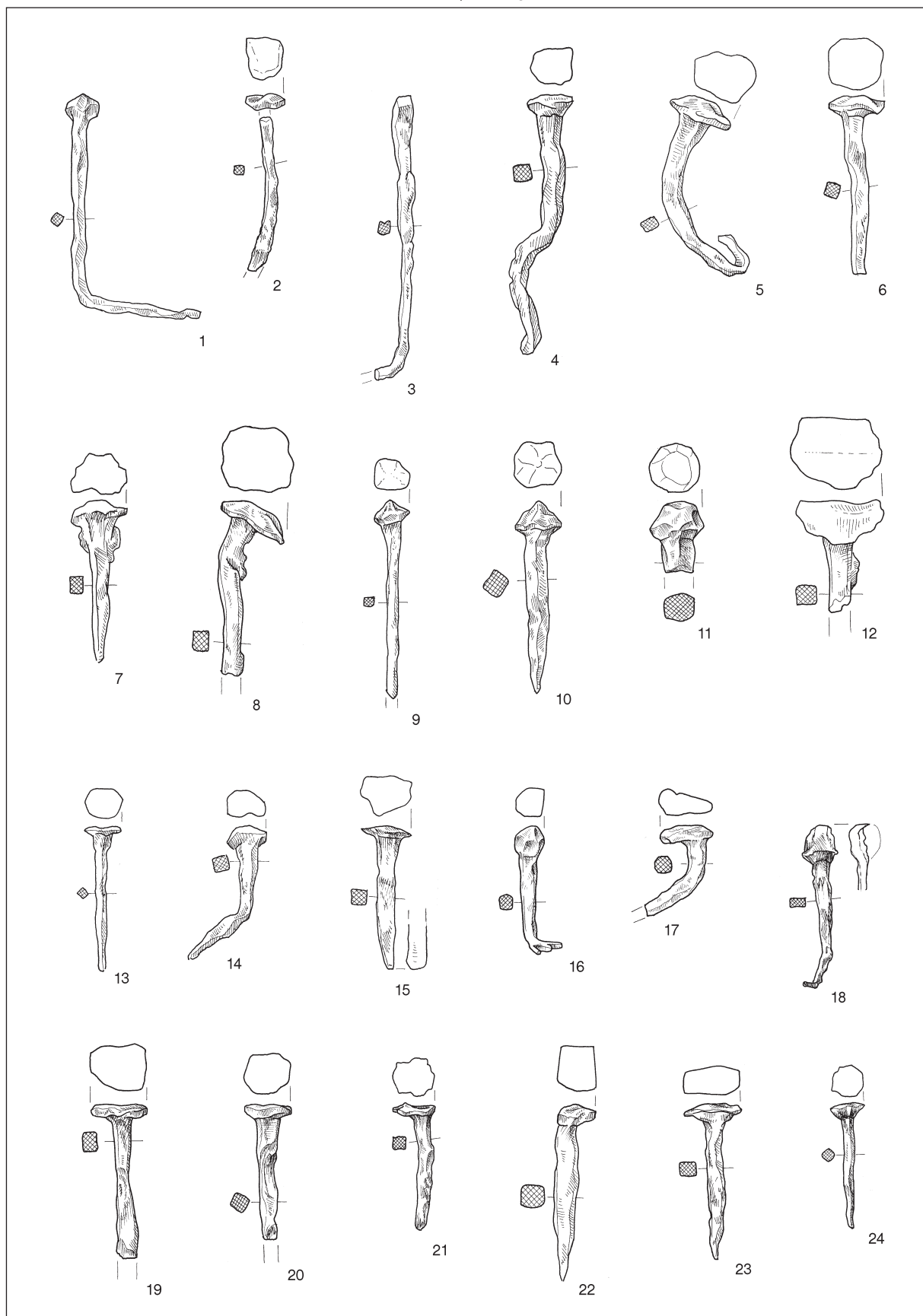

T. 35: Tonovcov grad, stavba 1. Vse železo. M. = 1:2.  
 Pl. 35: Tonovcov grad, building 1. All iron. Scale = 1:2.

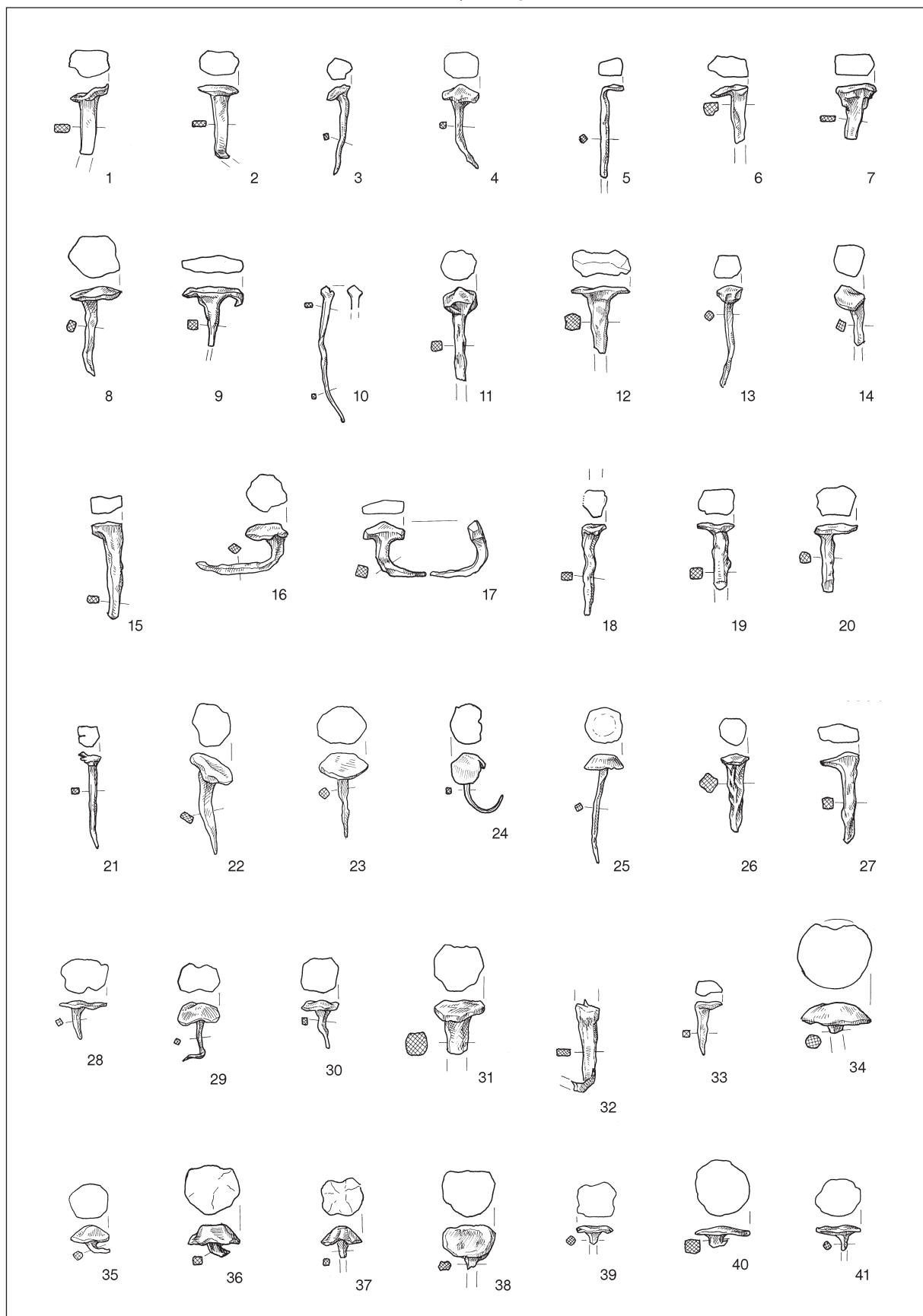

T. 36: Tonovcov grad, stavba 1. Vse železo. M. = 1:2.  
 Pl. 36: Tonovcov grad, building 1. All iron. Scale = 1:2.

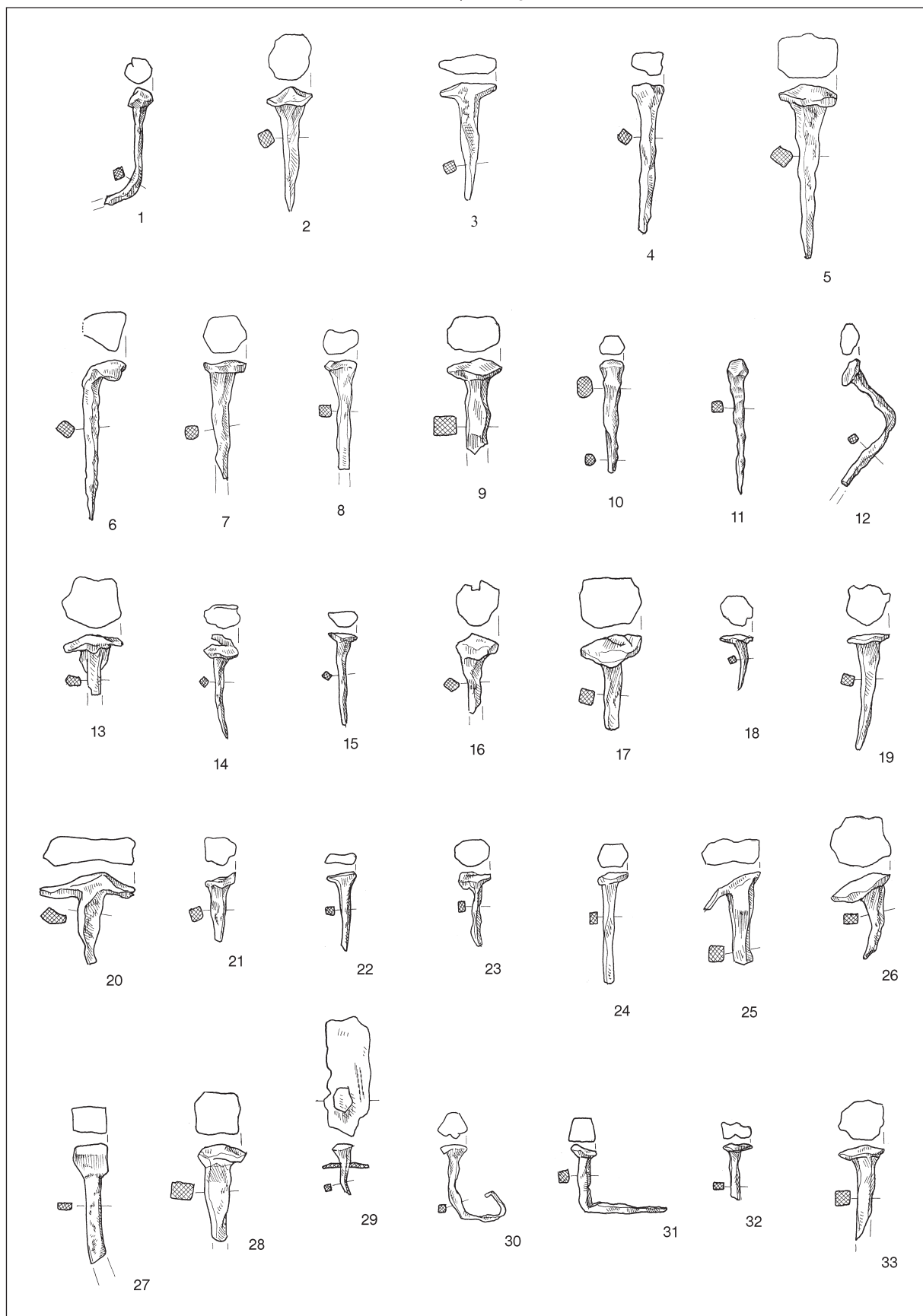

T. 37: Tonovcov grad, stavba 1. Vse železo. M. = 1:2.  
 Pl. 37: Tonovcov grad, building 1. All iron. Scale = 1:2.

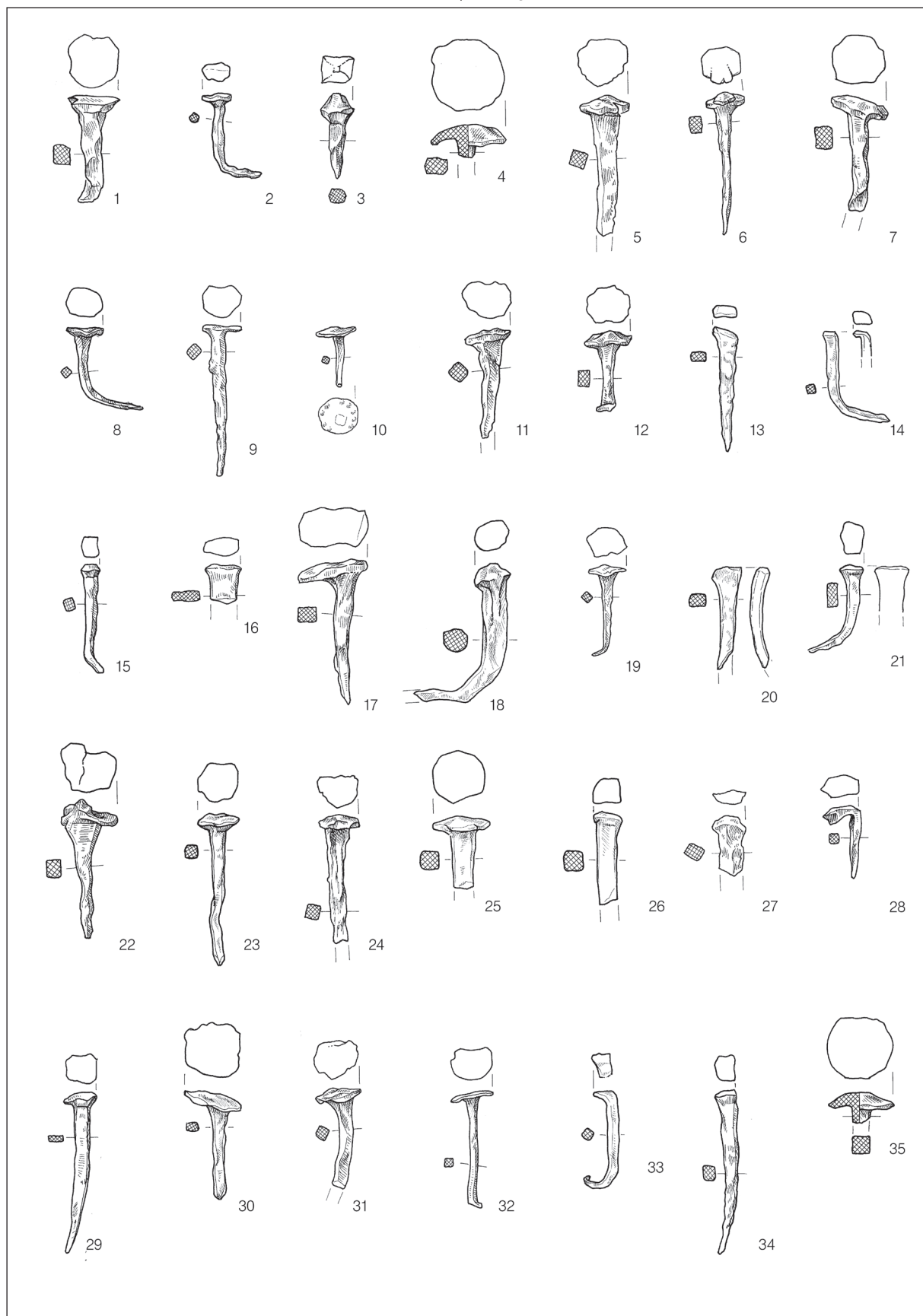

T. 38: Tonovcov grad, stavba 1. Vse železo. M. = 1:2.  
 Pl. 38: Tonovcov grad, building 1. All iron. Scale = 1:2.



TABLE / PLATES

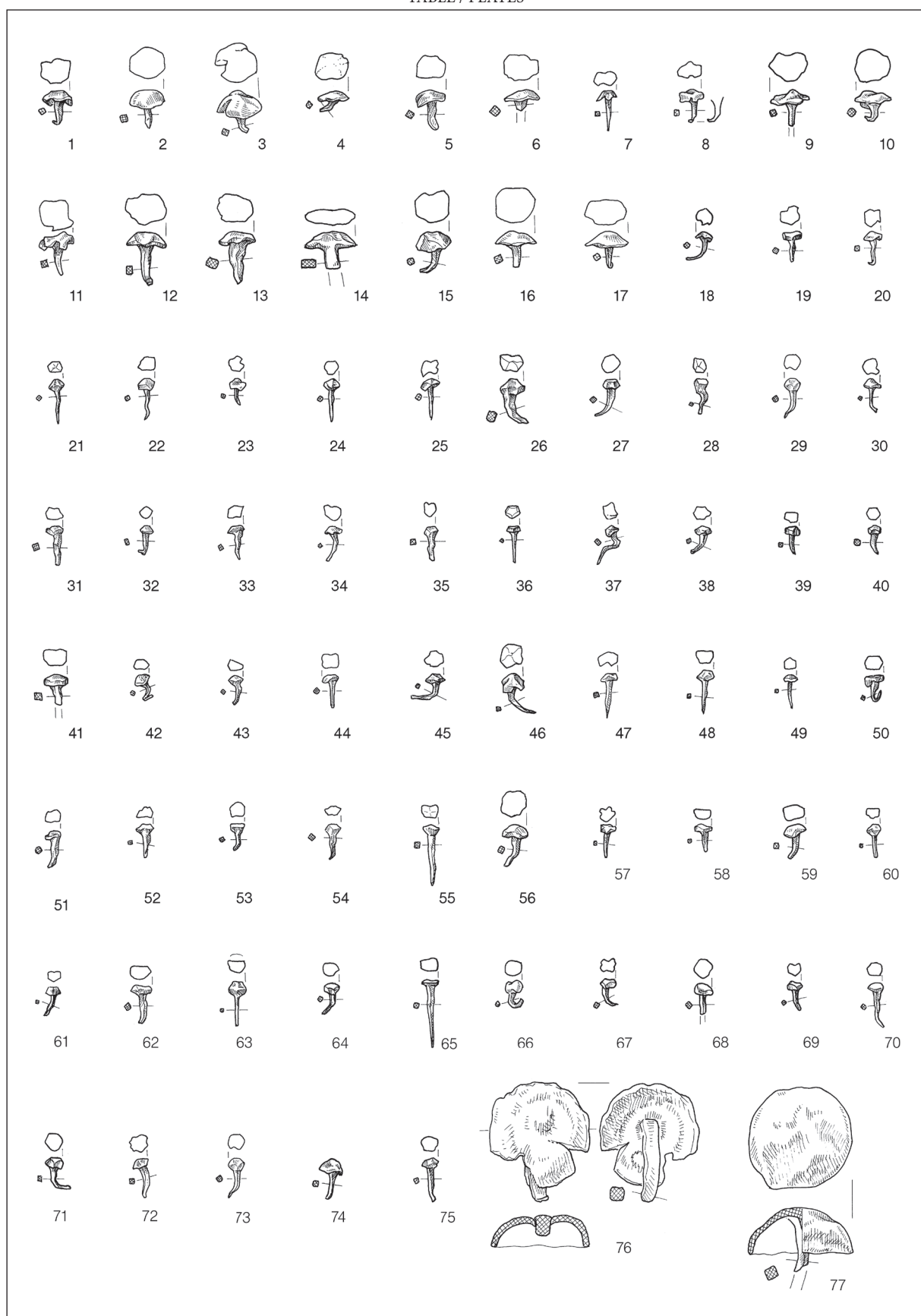

T. 39: Tonovcov grad, stavba 1. Vse železo. M. = 1:2.  
 Pl. 39: Tonovcov grad, building 1. All iron. Scale = 1:2.

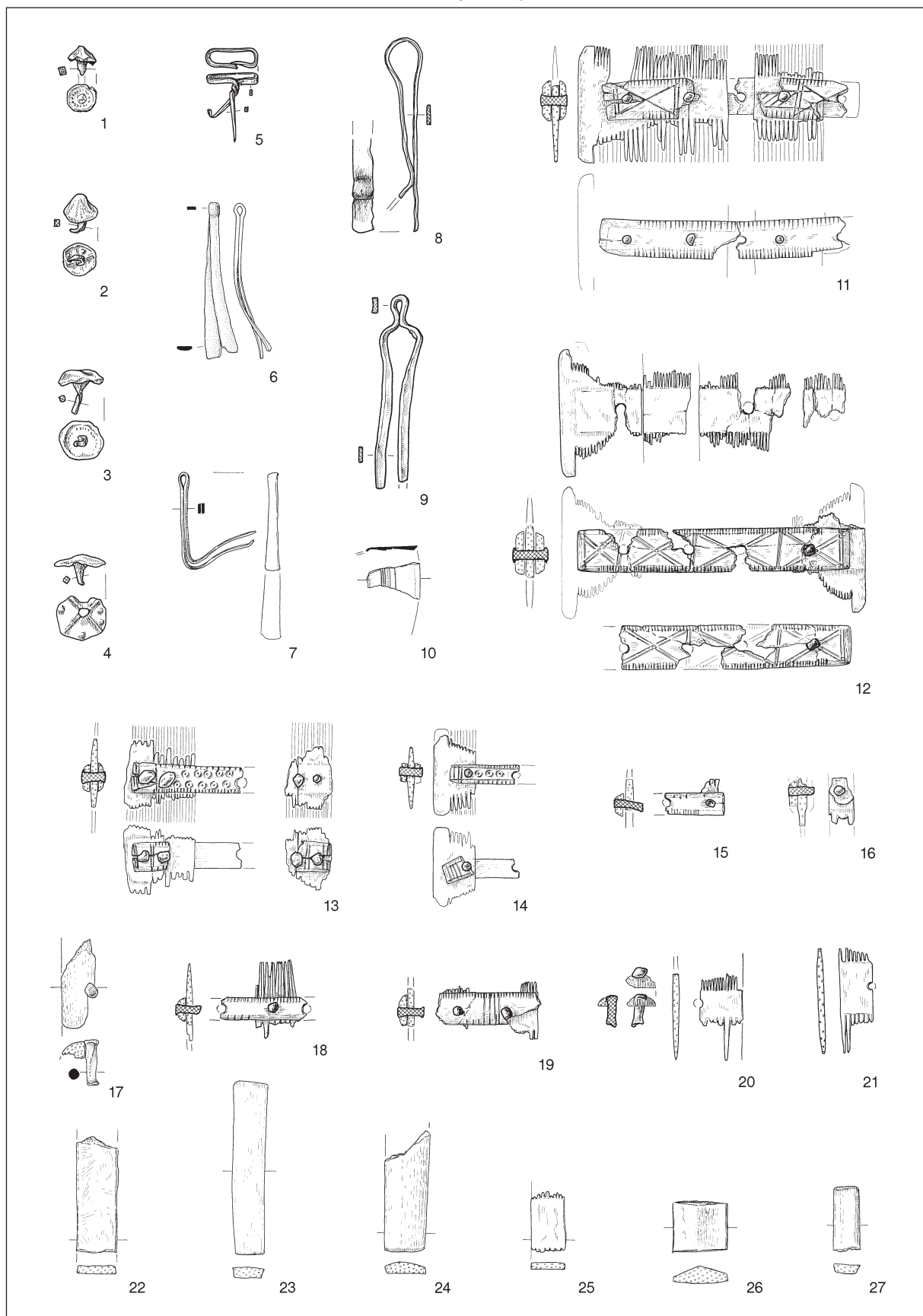

T. 40: Tonovcov grad, stavba 1. 1-5,8-9 železo; 6-7,10 bron; 11-16,18-20 rogovina, železo; 17 rogovina, bron; 21-27 rogovina. M. = 1:2.  
 Pl. 40: Tonovcov grad, building 1. 1-5,8-9 iron; 6-7,10 bronze; 11-16,18-20 antler, iron; 17 antler, bronze; 21-27 antler. Scale = 1:2.

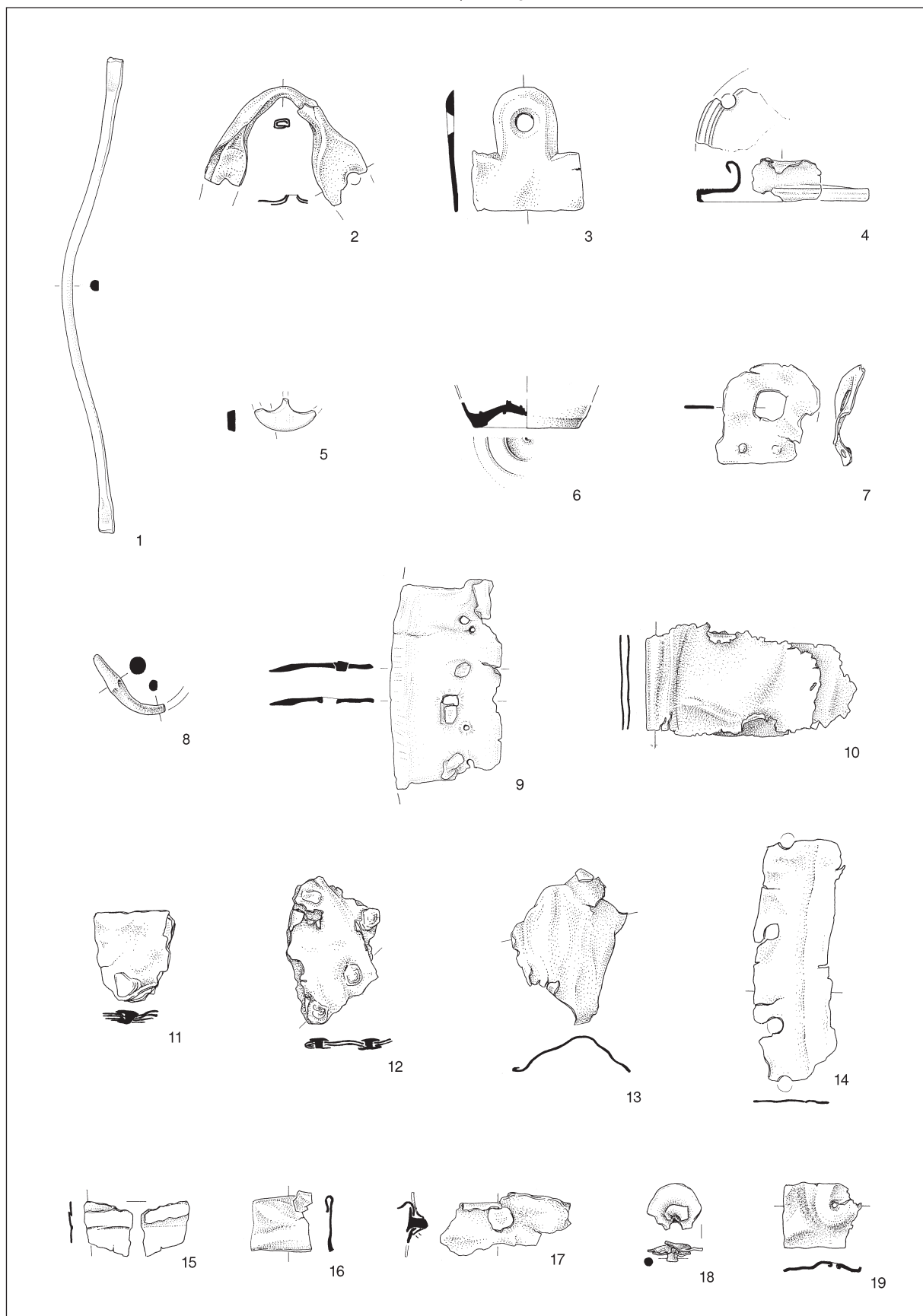

T. 41: Tonovcov grad, stavba 1. Vse bron. M. = 1:2.

Pl. 41: Tonovcov grad, building 1. All bronze. Scale = 1:2.

TABLE / PLATES

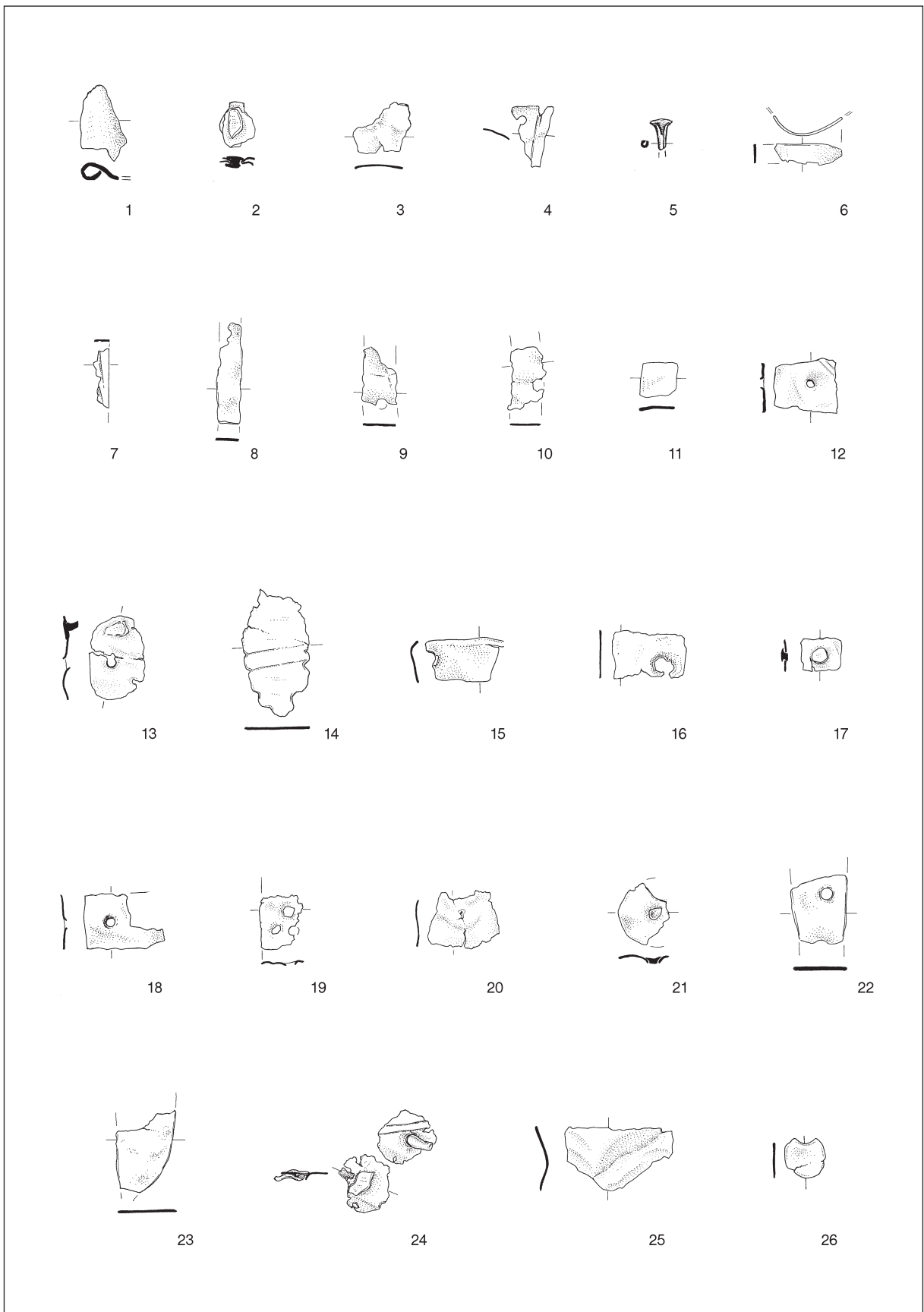

T. 42: Tonovcov grad, stavba 1. Vse bron. M. = 1:2.

Pl. 42: Tonovcov grad, building 1. All bronze. Scale = 1:2.

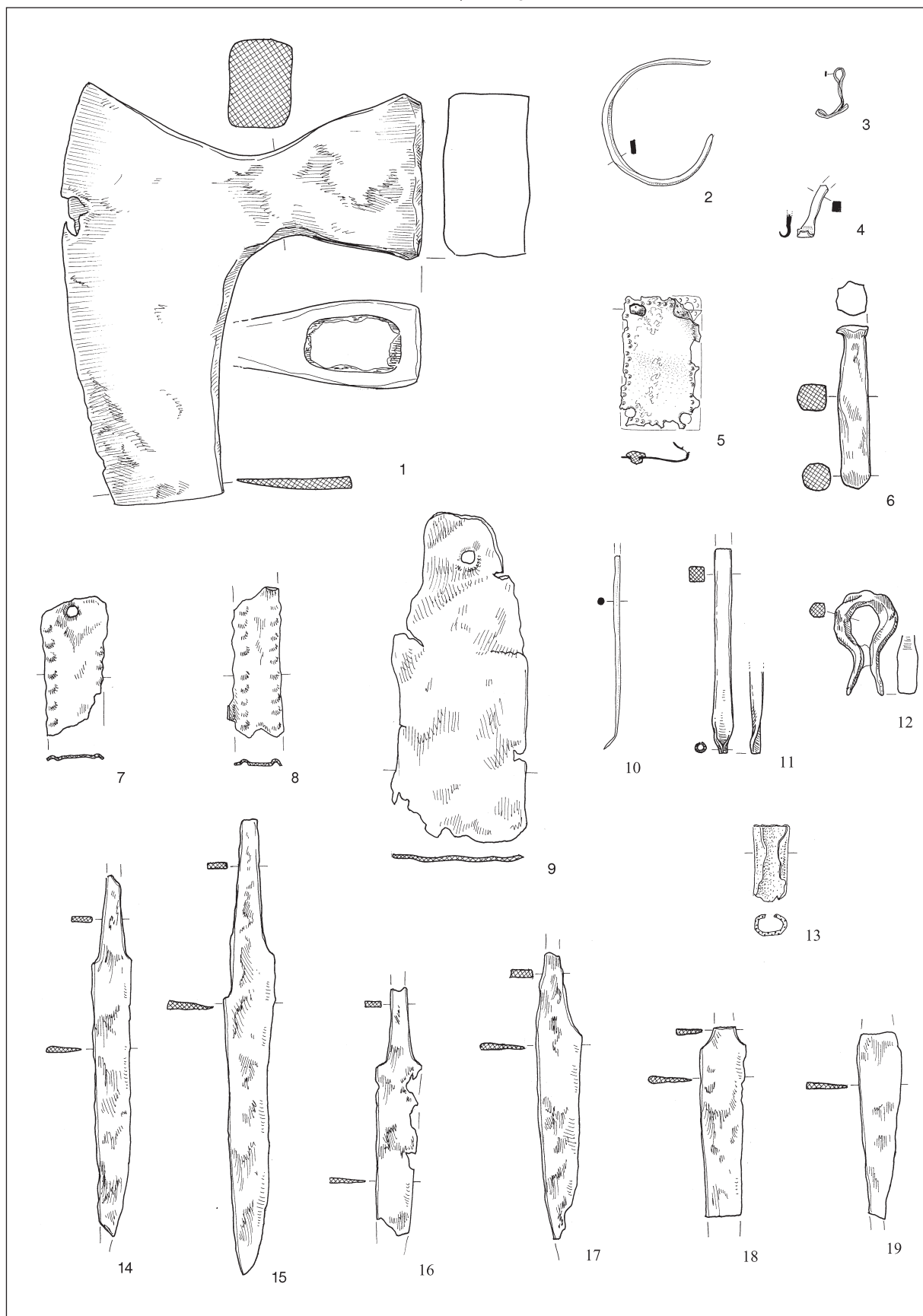

T. 43: Tonovcov grad, stavba 2. 1,6-9,11-12,14-19 železo; 2-4,10 bron; 5 bron, železo; 13 svinec. M. = 1:2.

Pl. 43: Tonovcov grad, building 2. 1,6-9,11-12,14-19 iron; 2-4,10 bronze; 5 bronze, iron; 13 lead. Scale = 1:2.

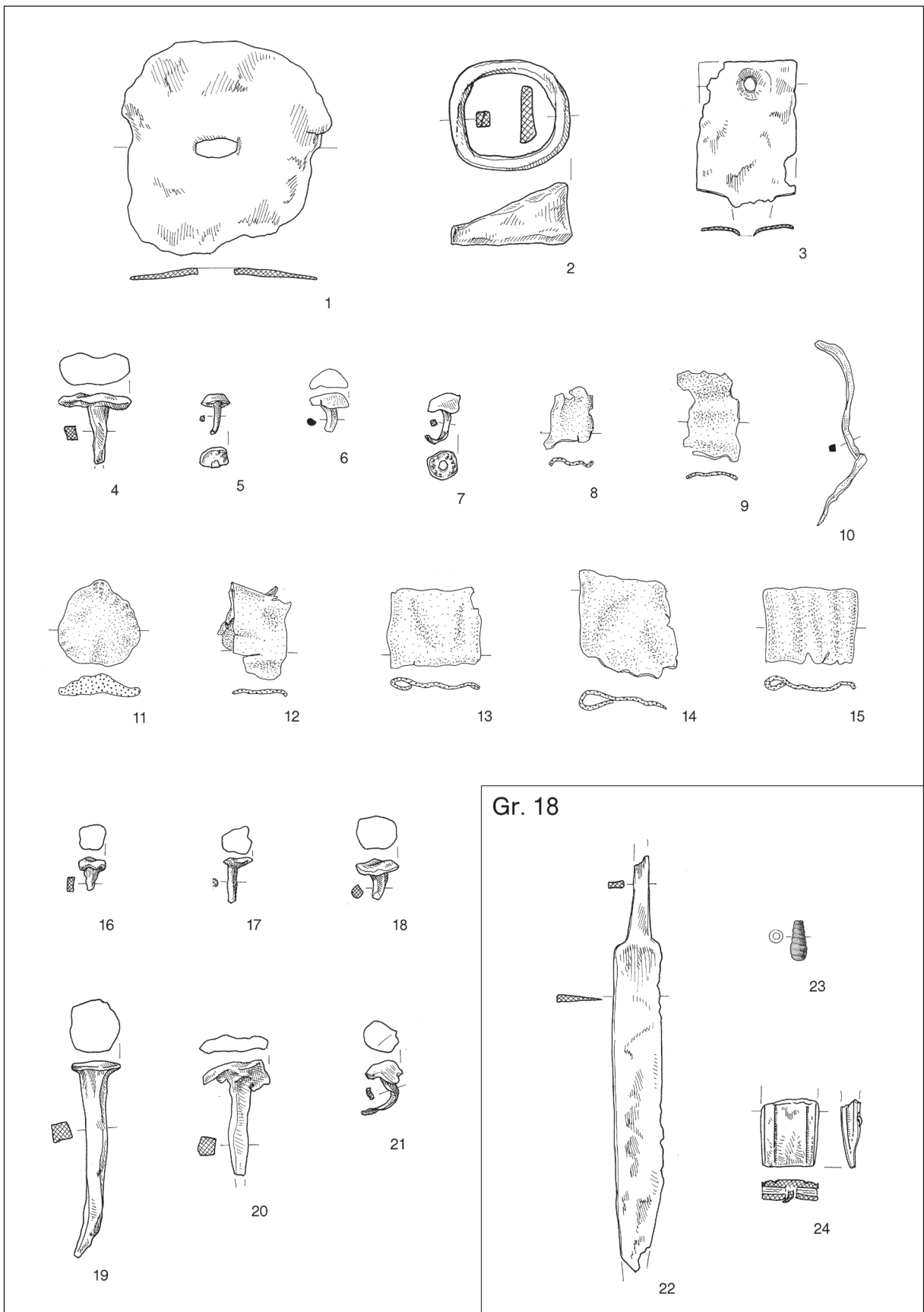

T. 44: Tonovcov grad, 1-21 stavba 2; 22-24 grob 18. 1-5,7,16-22,24 železo; 6,10 bron; 8-9,11-15 svinec; 23 steklo. M. = 1:2.  
 Pl. 44: Tonovcov grad, 1-21 building 2; 22-24 grave 18. 1-5,7,16-22,24 iron; 6,10 bronze; 8-9,11-15 lead; 23 glass. Scale = 1:2.

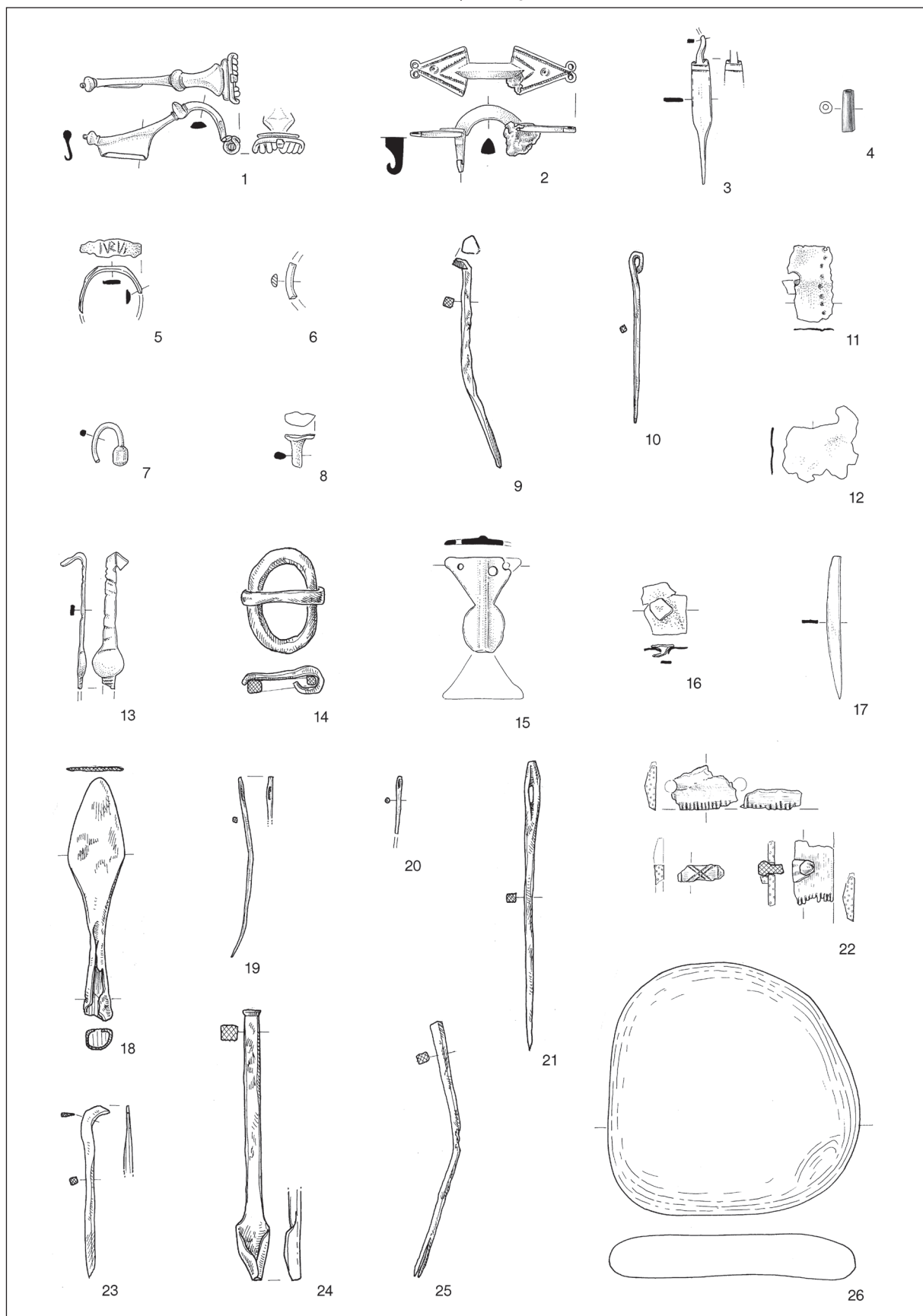

T. 45: Tonovcov grad, stavba 3. 1-3,5,7-8,11-13,15-17 bron; 4 steklo; 6 srebro; 9-10,14,18-21,23-25 železo; 22 rogovina, železo; 26 kamen. M. = 1:2.

Pl. 45: Tonovcov grad, building 3. 1-3,5,7-8,11-13,15-17 bronze; 4 glass; 6 silver; 9-10,14,18-21,23-25 iron; 22 antler, iron; 26 stone. Scale = 1:2.

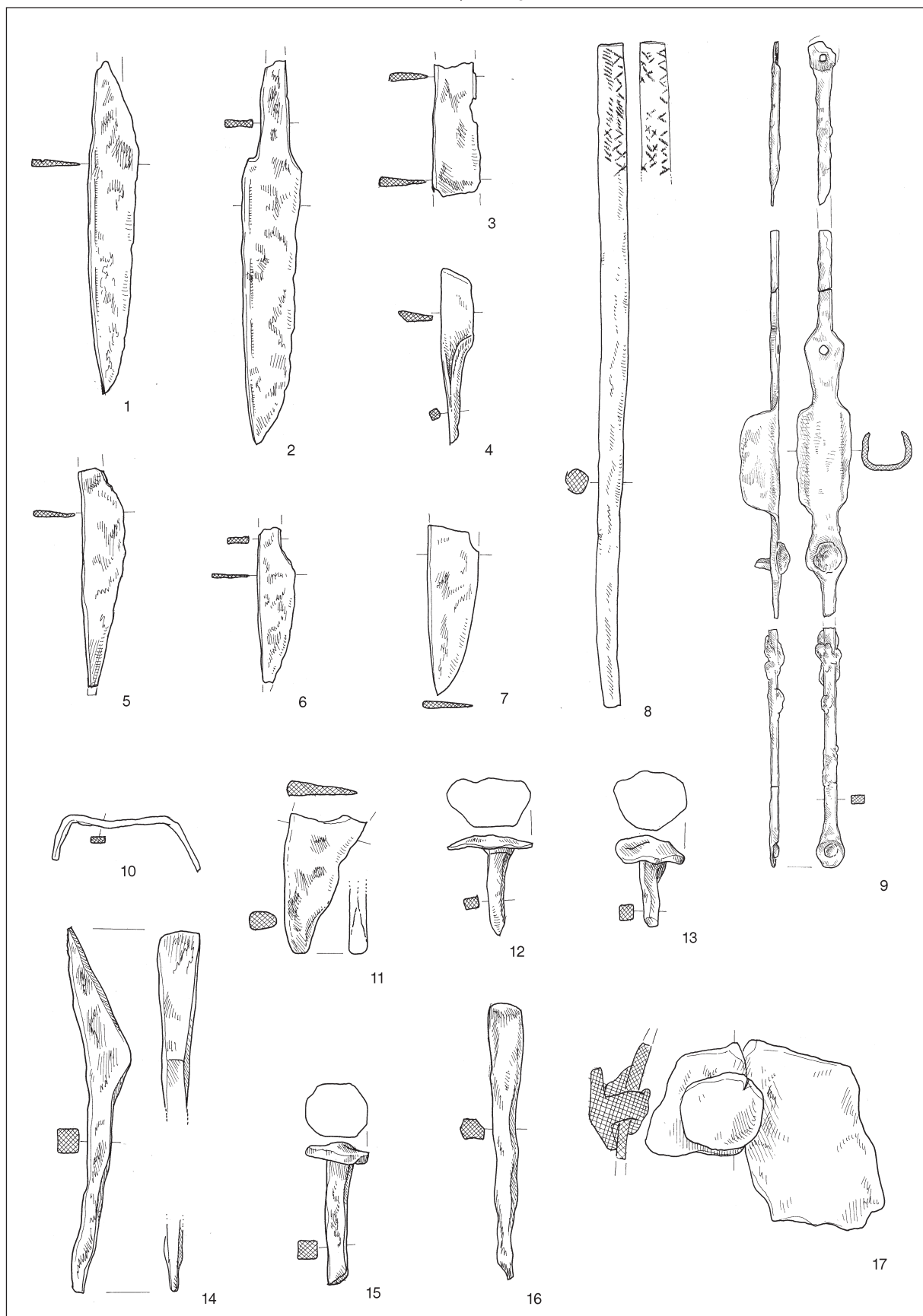

T. 46: Tonovcov grad, stavba 3. Vse železo. M. 1-8,10-17 = 1:2; 9 = 1:3.

Pl. 46: Tonovcov grad, building 3. All iron. Scale 1-8,10-17 = 1:2; 9 = 1:3.



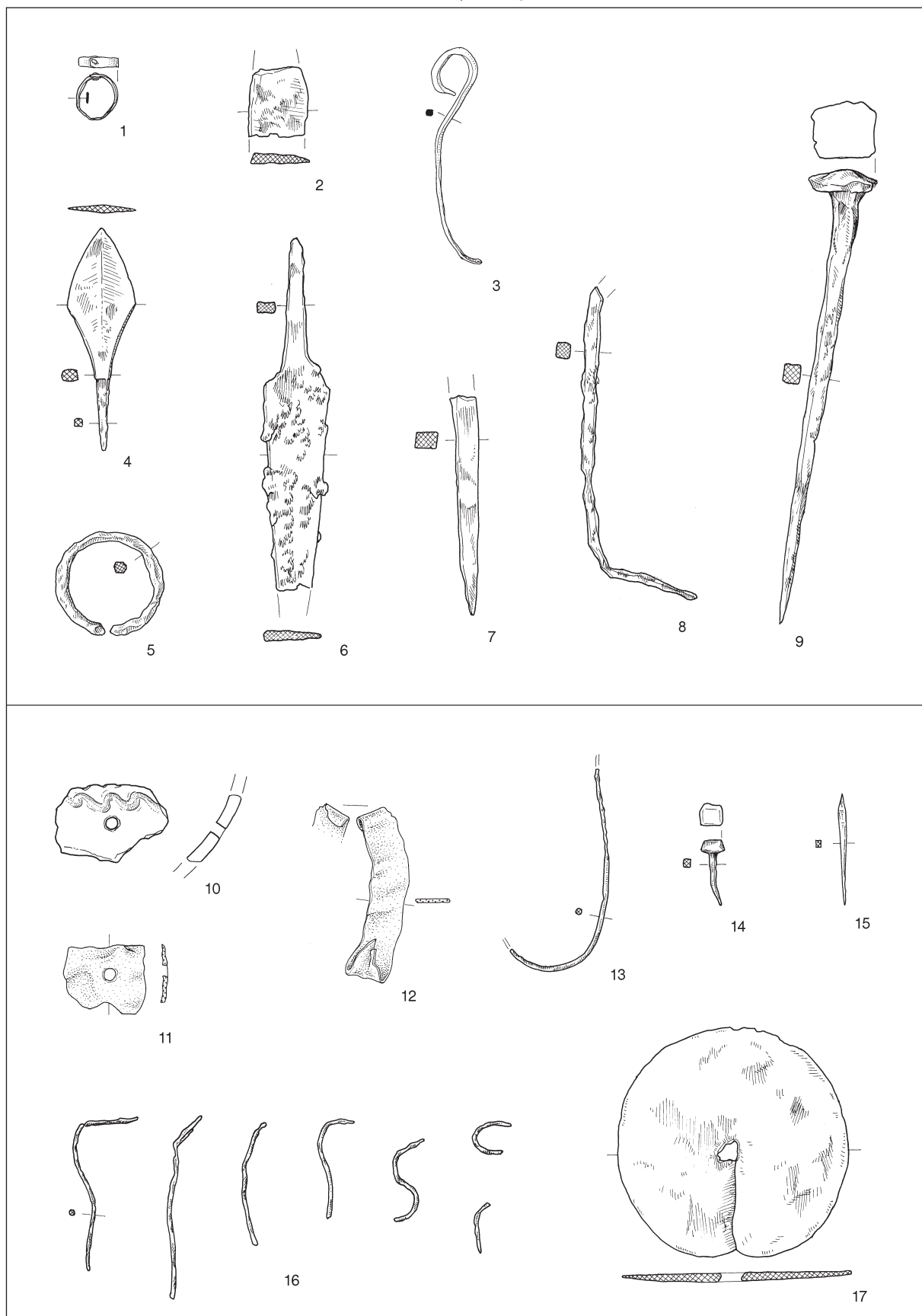

T. 47: Tonovcov grad, sklop cerkva. 1,3 bron; 2,4-9,13-17 železo; 10 keramika; 11-12 svinec. M. = 1:2.

Pl. 47: Tonovcov grad, ecclesiastical complex. 1,3 bronze; 2,4-9,13-17 iron; 10 pottery; 11-12 lead. Scale = 1:2.

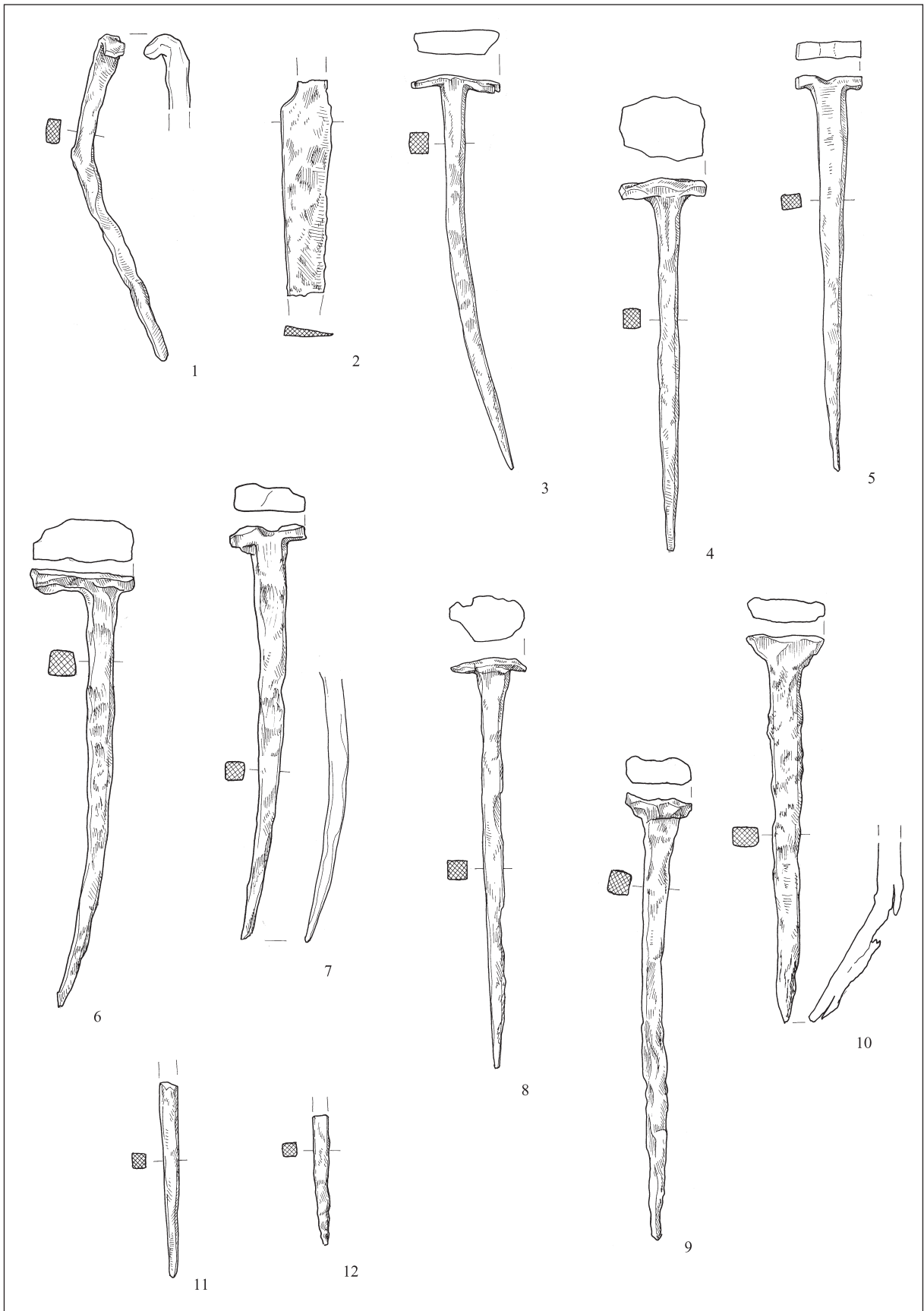

T. 48: Tonovcov grad, sklop cerkva. Vse železo. M. = 1:2.

Pl. 48: Tonovcov grad, ecclesiastical complex. All iron. Scale = 1:2.

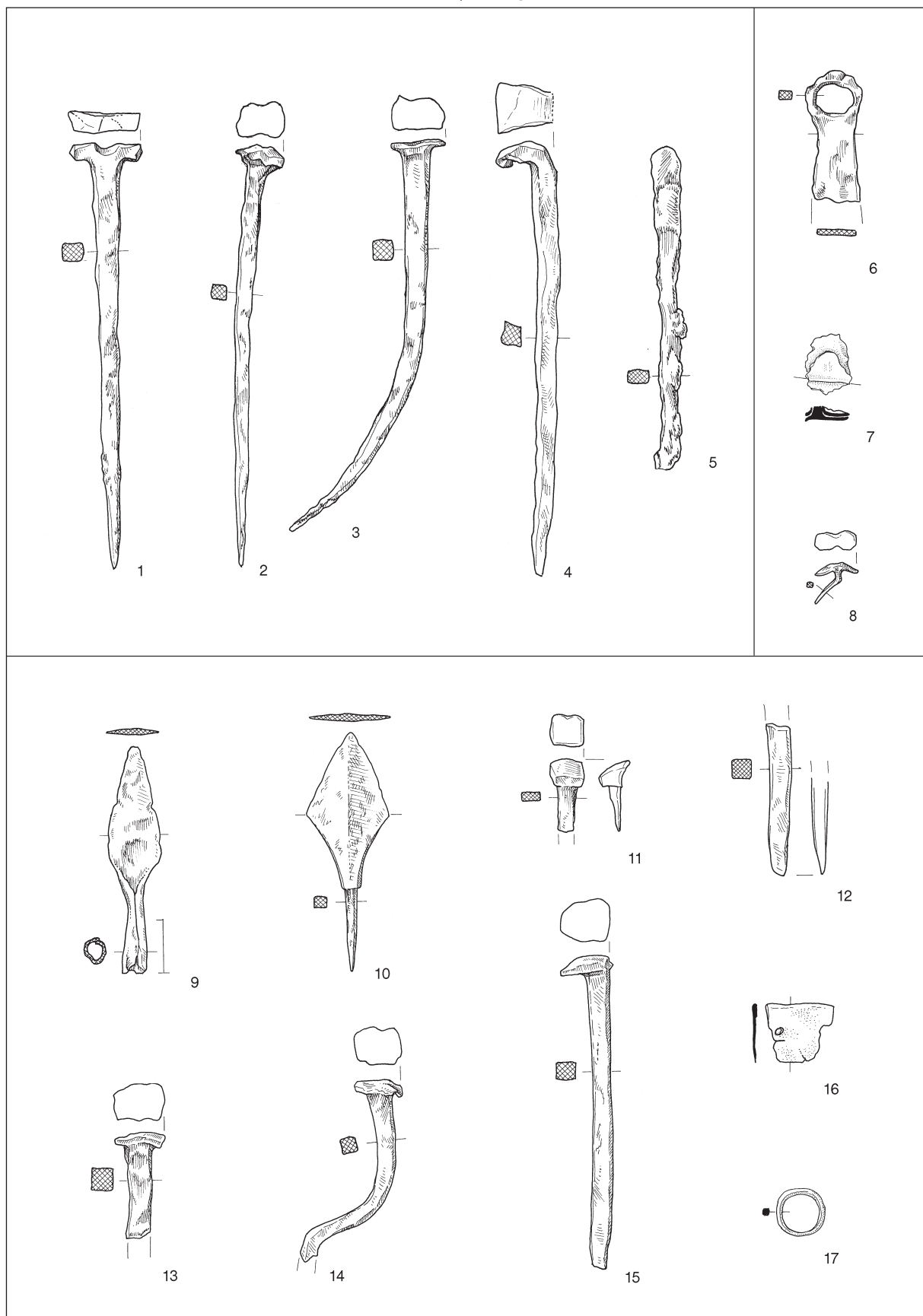

T. 49: Tonovcov grad, sklop cerkva. 1-6,8-15 železo; 7,16-17 bron. M. = 1:2.

Pl. 49: Tonovcov grad, ecclesiastical complex. 1-6,8-15 iron; 7,16-17 bronze. Scale = 1:2.

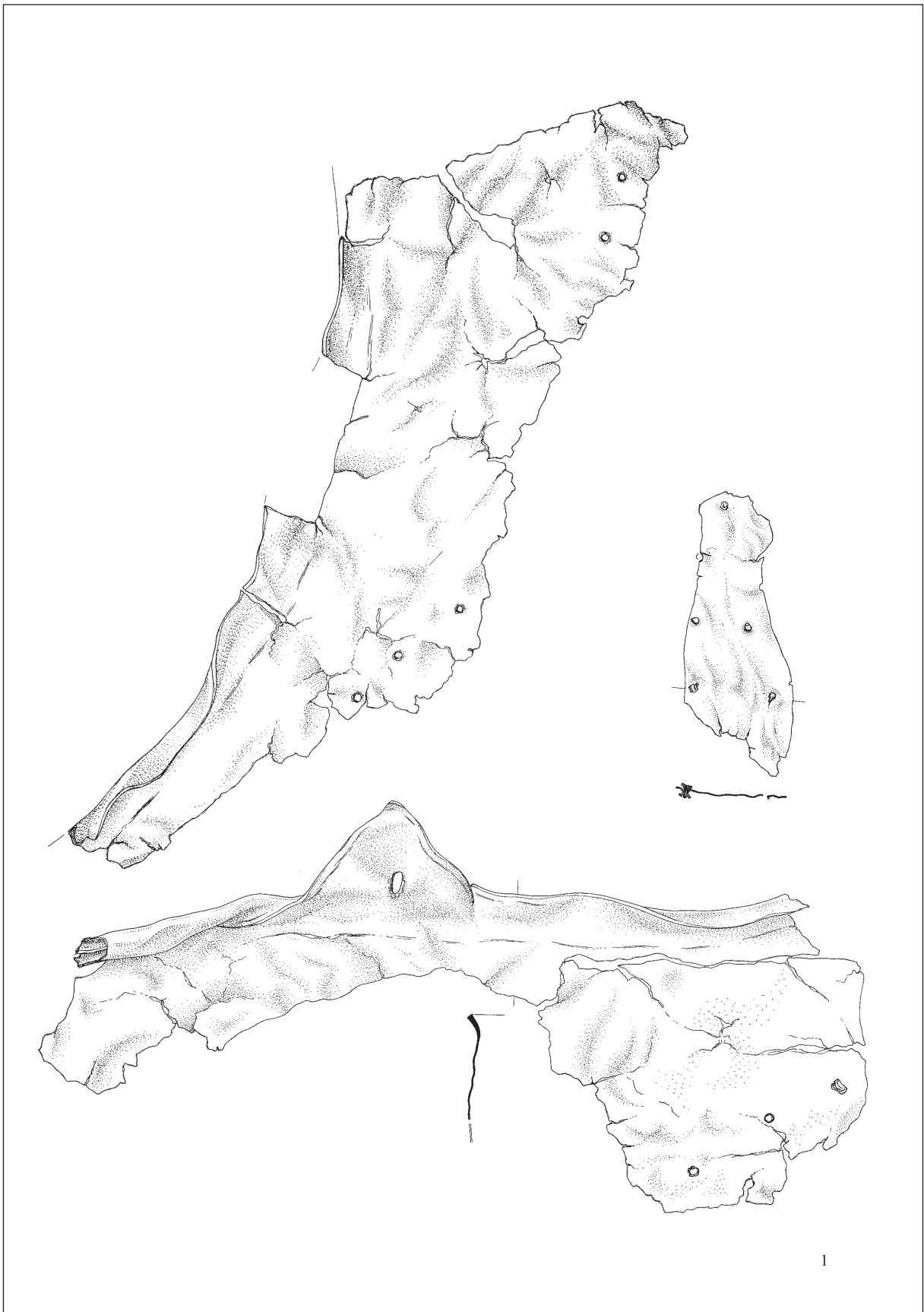

*T. 50:* Tonovcov grad, sklop cerkva. Vse bron. M. 2:5.

*Pl. 50:* Tonovcov grad, ecclesiastical complex. All bronze. Scale 2:5.

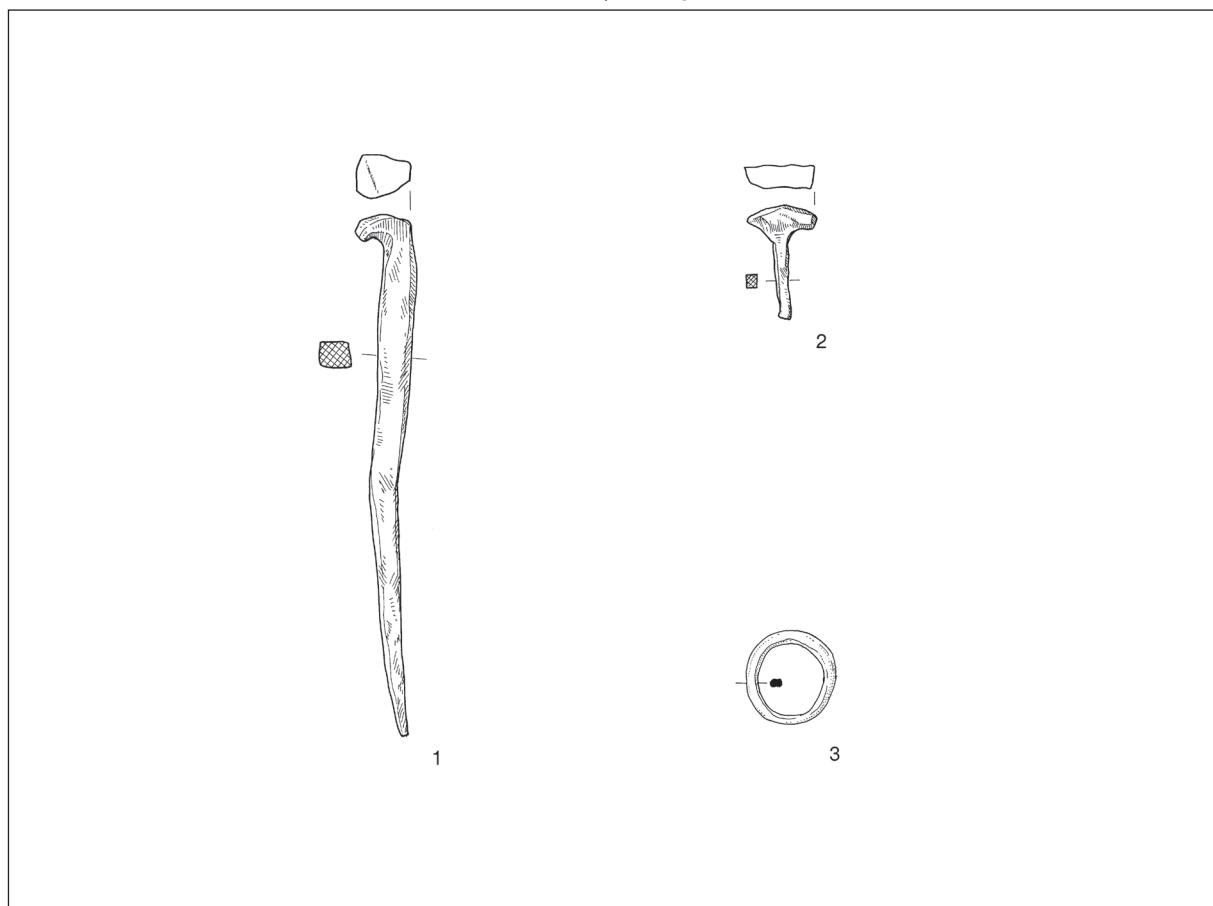

Gr. 3

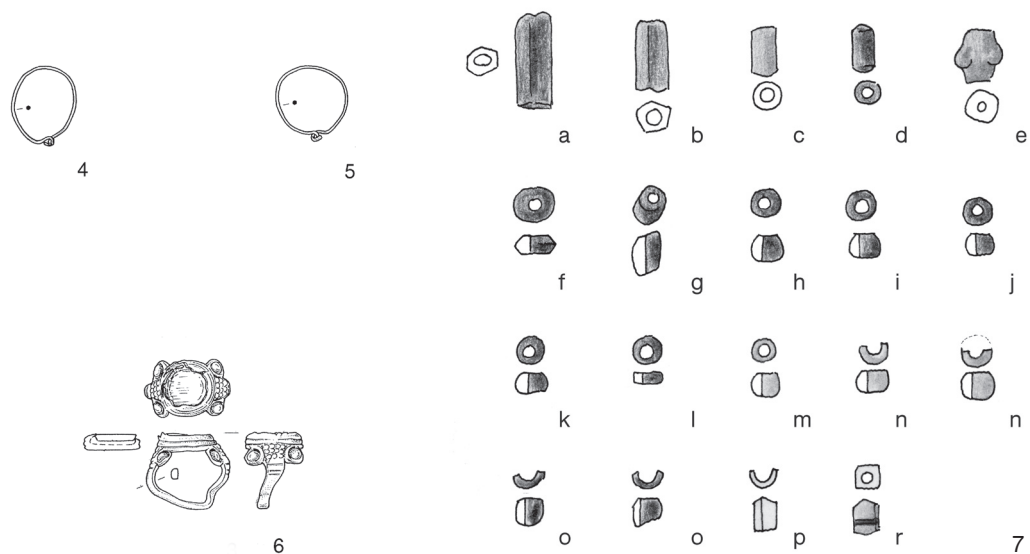

*T. 51:* Tonovcov grad, 1–3 sklop cerkva; 4–7 grob 3. 1–2 železo; 3–5 bron; 6 srebro in steklo ali kamen; 7 steklo. M. 1–6 = 1:2; 7 = 1:1.  
*Pl. 51:* Tonovcov grad, 1–3 ecclesiastical complex; 4–7 grave 3. 1-2 iron; 3-5 bronze; 6 silver and glass or stone; 7 glass. Scale 1-6 = 1:2; 7 = 1:1.

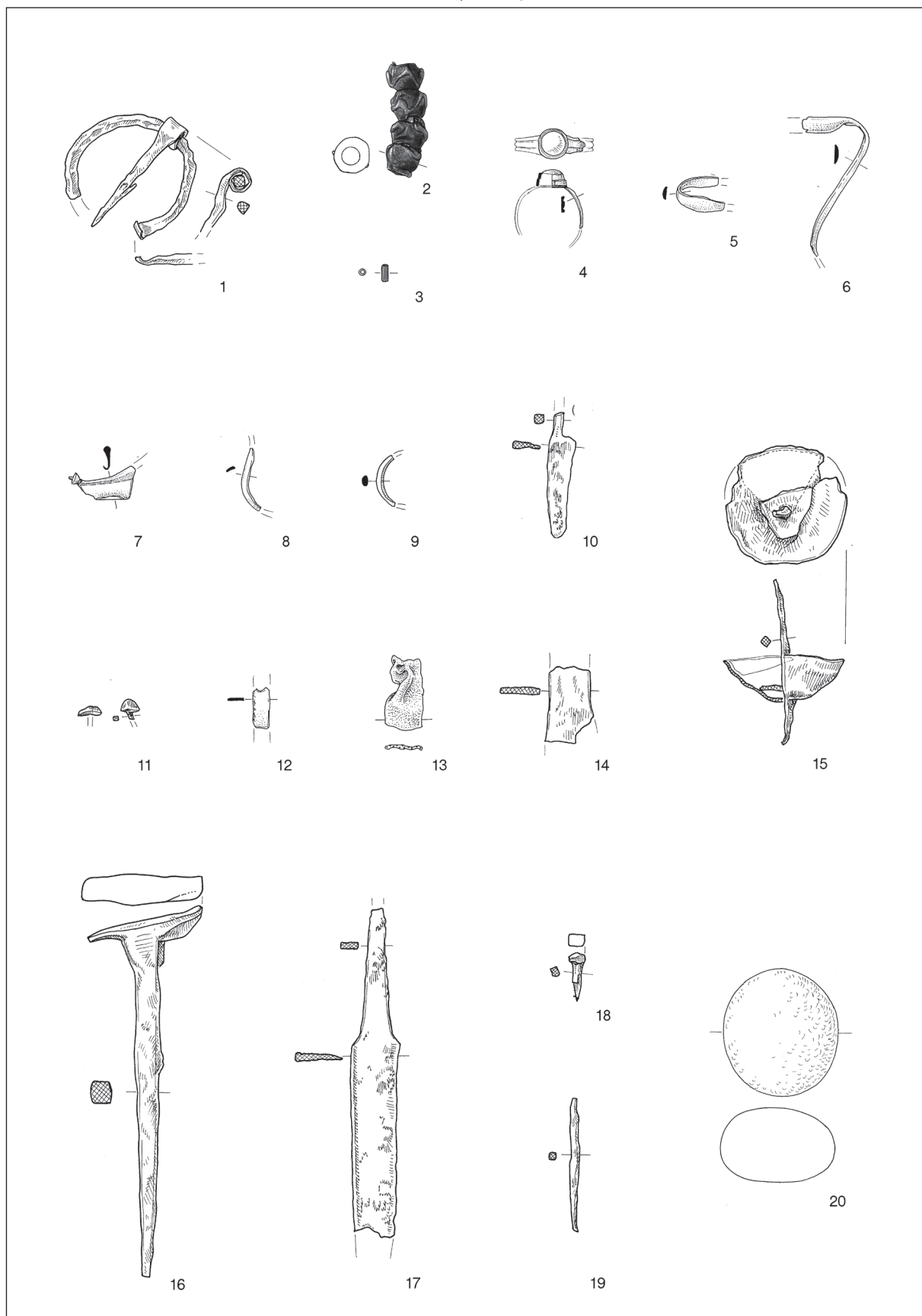

*T. 52:* Tonovcov grad, prostor med osrednjo in južno cerkvijo. 1,10–11,14–19 železo; 2–3 steklo; 4 bron in steklo ali kamen; 5–9,12 bron; 13 svinec; 20 kamen. M. = 1:2.

*Pl. 52:* Tonovcov grad, the area between the north and main church. 1,10–11,14–19 iron; 2–3 glass; 4 bronze and glass or stone; 5–9,12 bronze; 13 lead; 20 stone. Scale = 1:2.

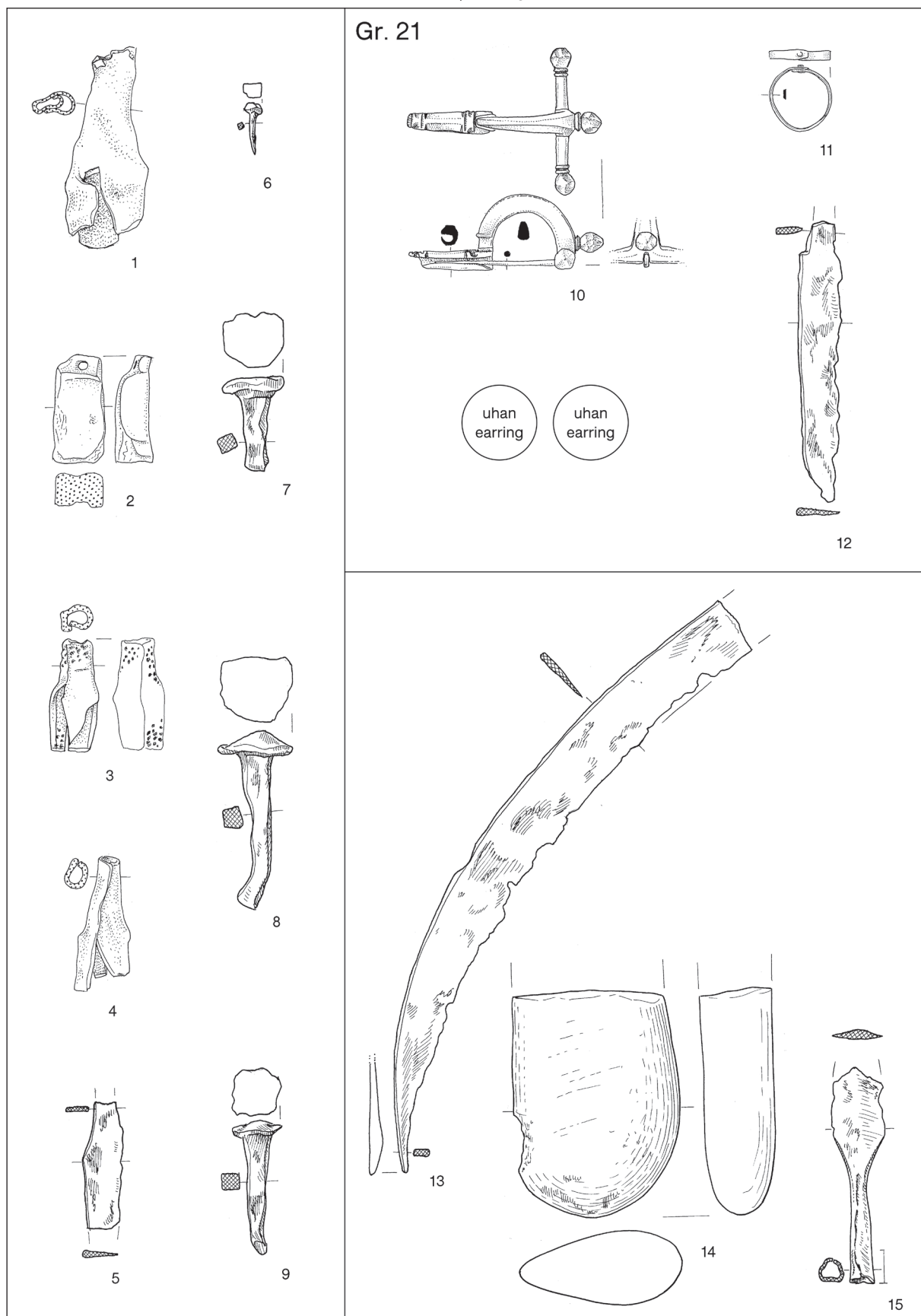

*T.* 53: Tonovcov grad, 1–9 prostor med osrednjo in južno cerkvijo; 10–12 grob 21; 13–15 cisterna. 1–4 svinec; 5–9,12–13,15 železo; 10–11 bron; 14 kamen. M. = 1:2.

*Pl.* 53: Tonovcov grad, 1–9 the area between the north and main church; 10–12 grave 21; 13–15 cistern. 1–4 lead; 5–9,12–13,15 iron; 10–11 bronze; 14 stone. Scale = 1:2.

TABLE / PLATES

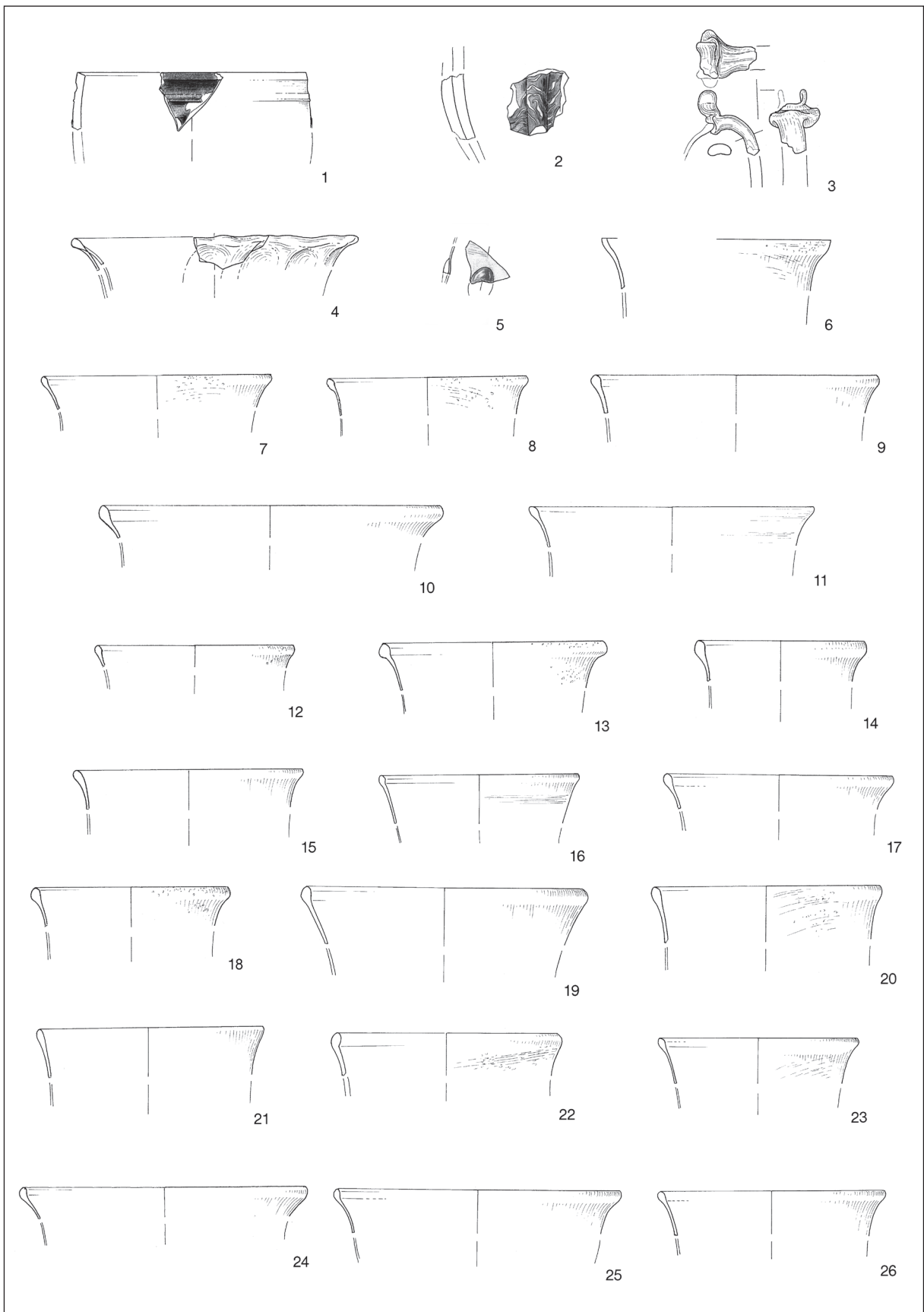

T. 54: Tonovcov grad, stavba 1. Vse steklo. M. = 1:2.

Pl. 54: Tonovcov grad, building 1. All glass. Scale = 1:2.



TABLE / PLATES

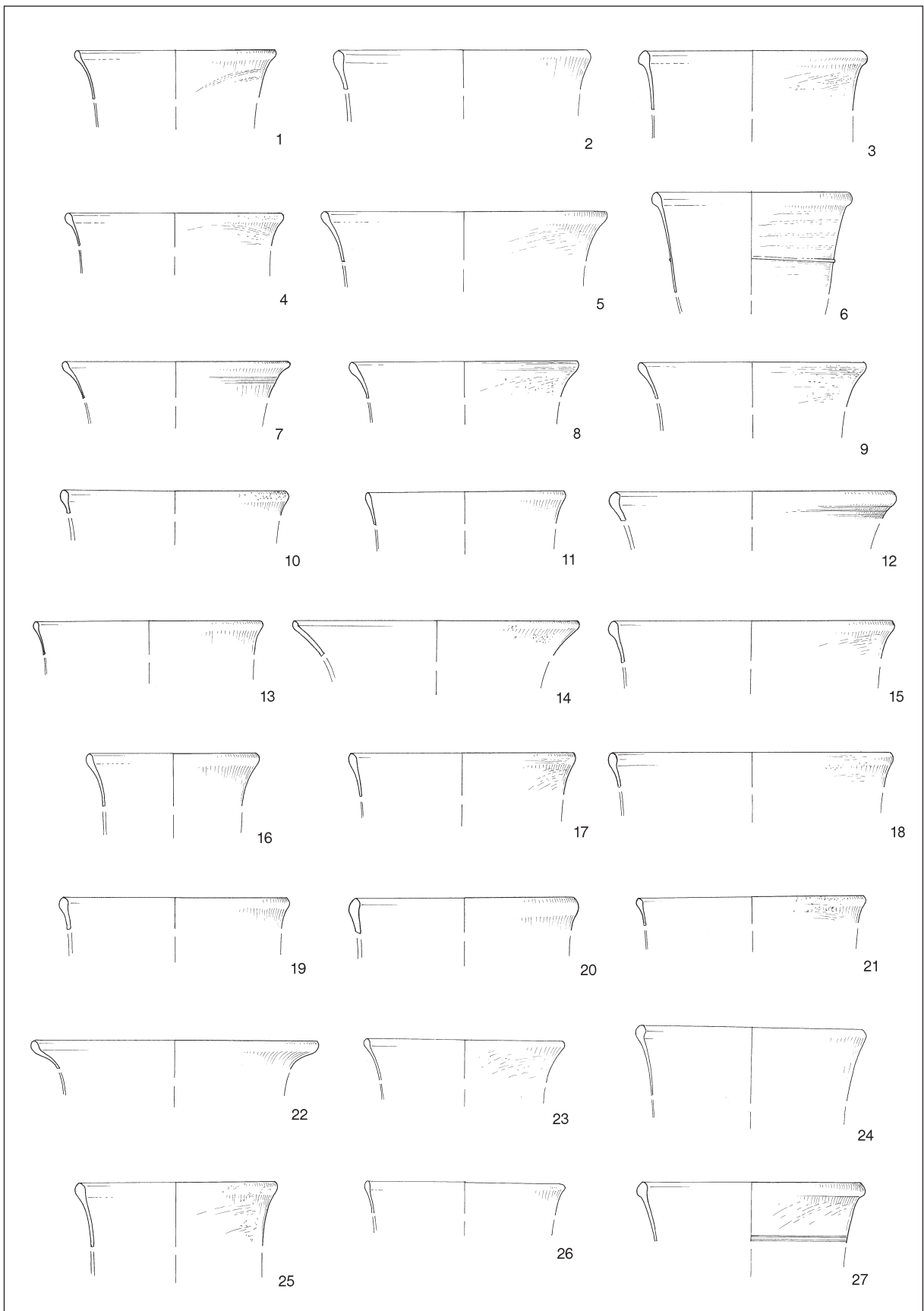

T. 55: Tonovcov grad, stavba 1. Vse steklo. M. = 1:2.

Pl. 55: Tonovcov grad, building 1. All glass. Scale = 1:2.

TABLE / PLATES

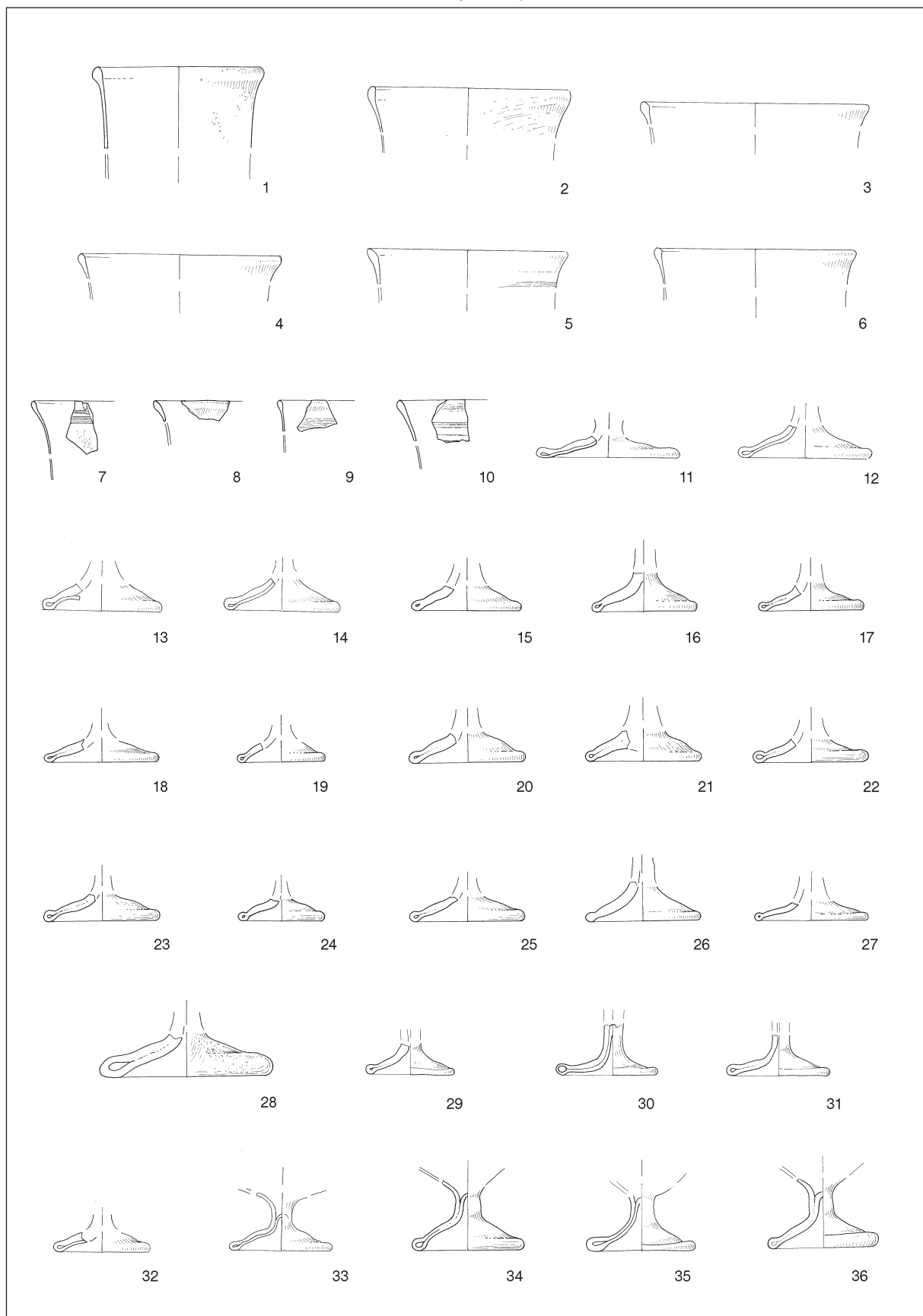

T. 56: Tonovcov grad, stavba 1. Vse steklo. M. = 1:2.

Pl. 56: Tonovcov grad, building 1. All glass. Scale = 1:2.

TABLE / PLATES

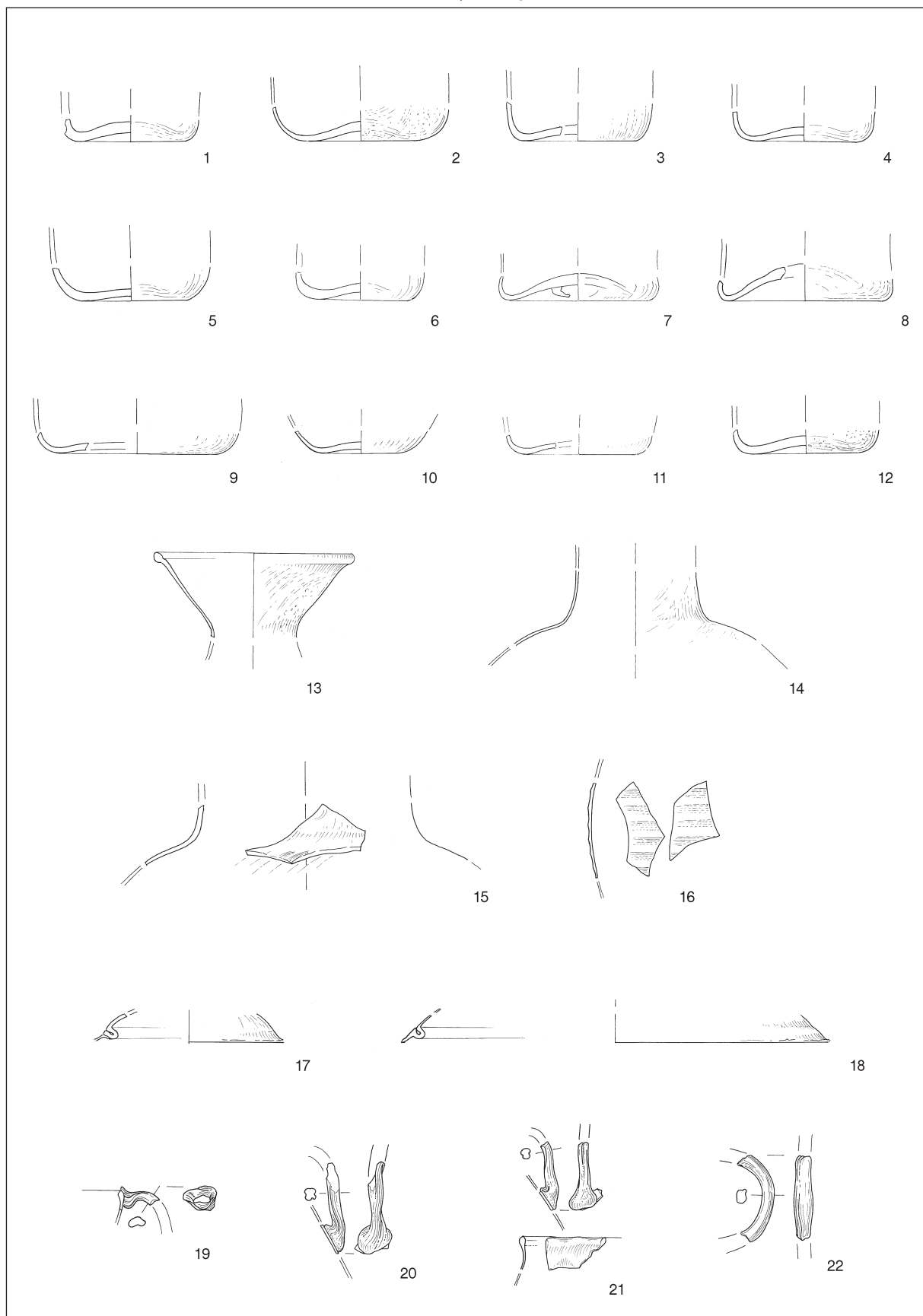

T. 57: Tonovcov grad, stavba 1. Vse steklo. M. = 1:2.

Pl. 57: Tonovcov grad, building 1. All glass. Scale = 1:2.

TABLE / PLATES

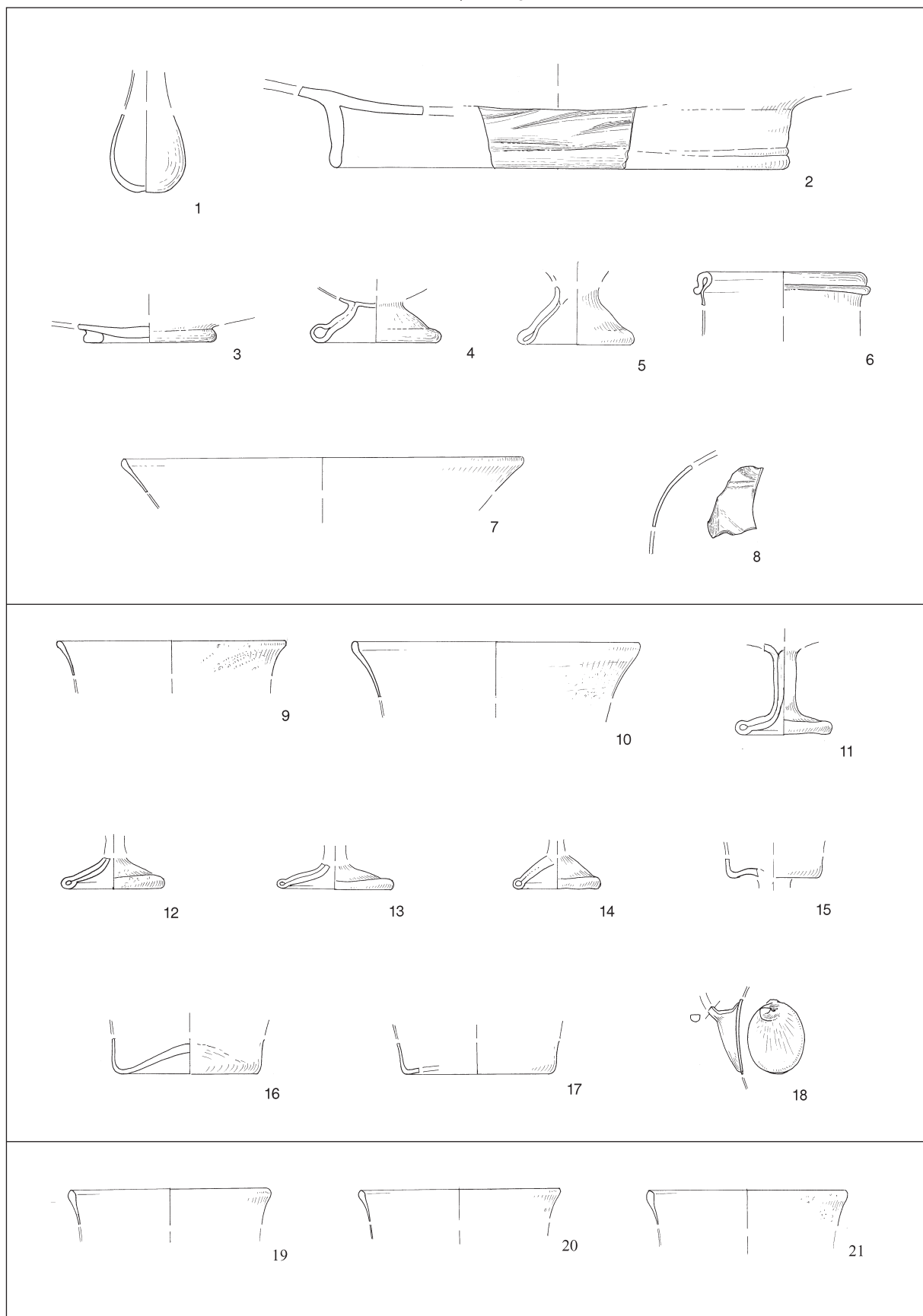

T. 58: Tonovcov grad, 1-8 stavba 1; 9-18 stavba 2; 19-21 stavba 3. Vse steklo. M. = 1:2.

Pl. 58: Tonovcov grad, 1-8 building 1; 9-18 building 2; 19-21 building 3. All glass. Scale = 1:2.

TABLE / PLATES

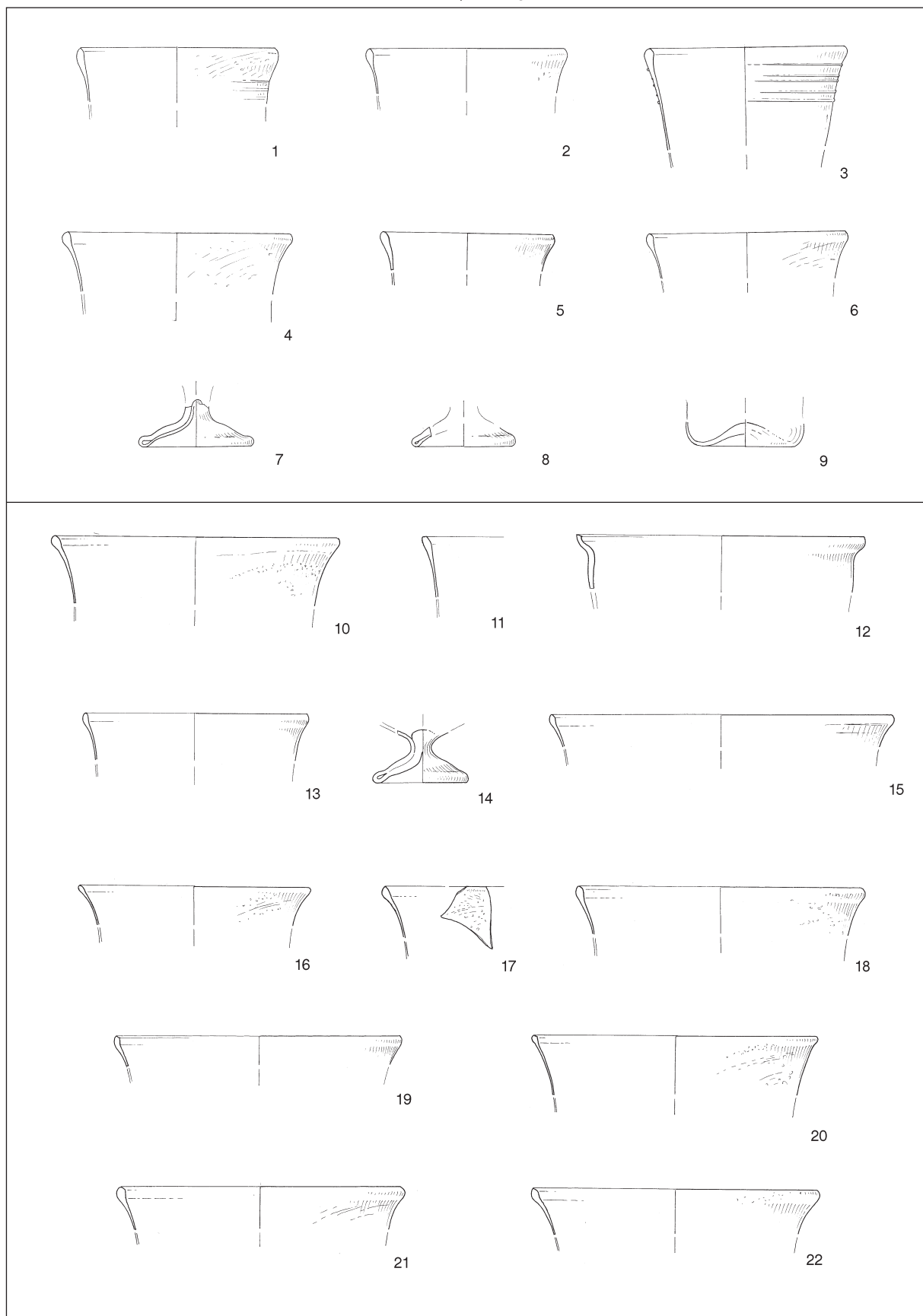

*T. 59:* Tonovcov grad, 1–9 stavba 3; 10–22 sklop cerkva. Vse steklo. M. = 1:2.

*Pl. 59:* Tonovcov grad, 1–9 building 3; 10–22 ecclesiastical complex. All glass. Scale = 1:2.

TABLE / PLATES

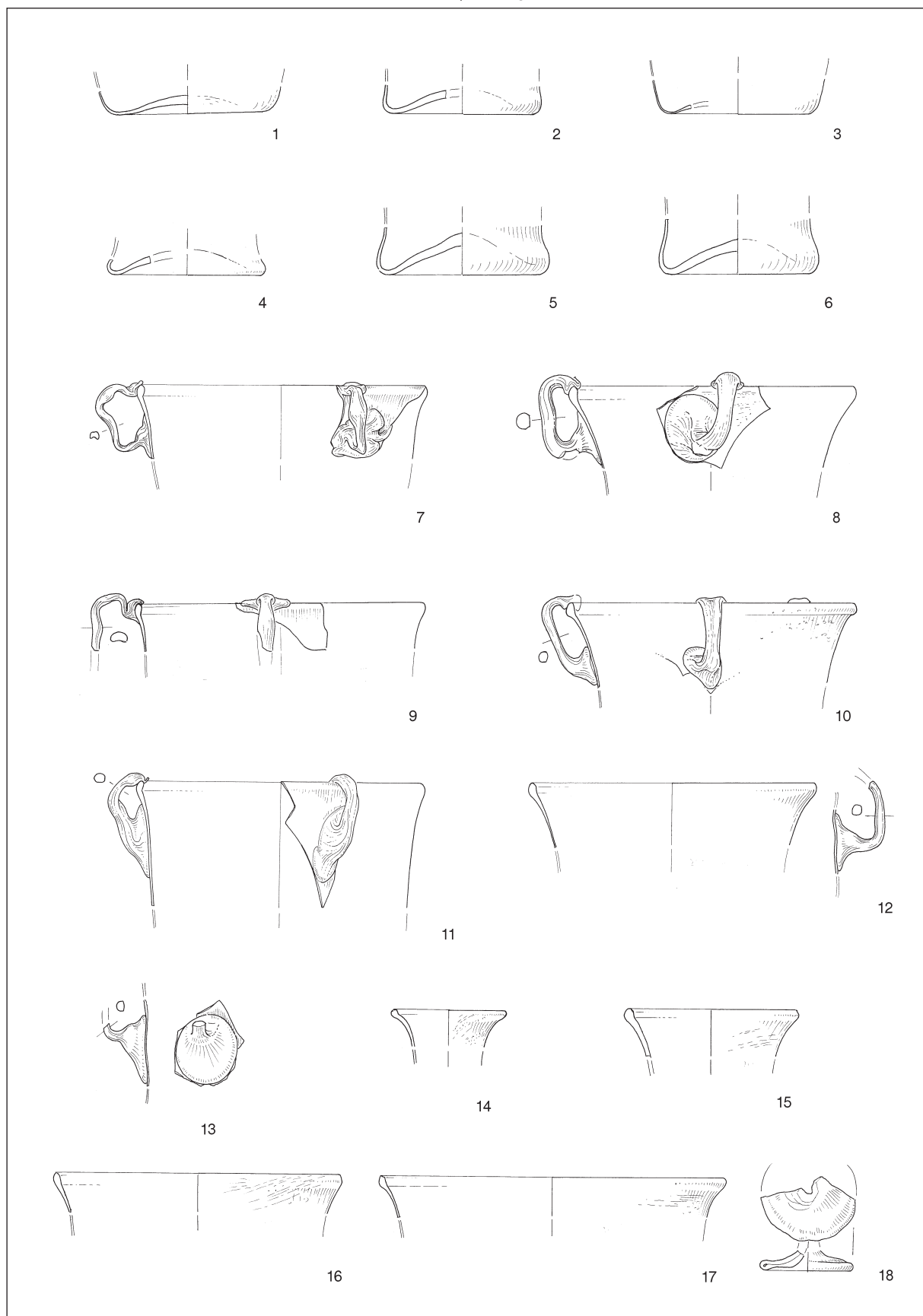

T. 60: Tonovcov grad, sklop cerkva. Vse steklo. M. = 1:2.

Pl. 60: Tonovcov grad, ecclesiastical complex. All glass. Scale = 1:2.

TABLE / PLATES

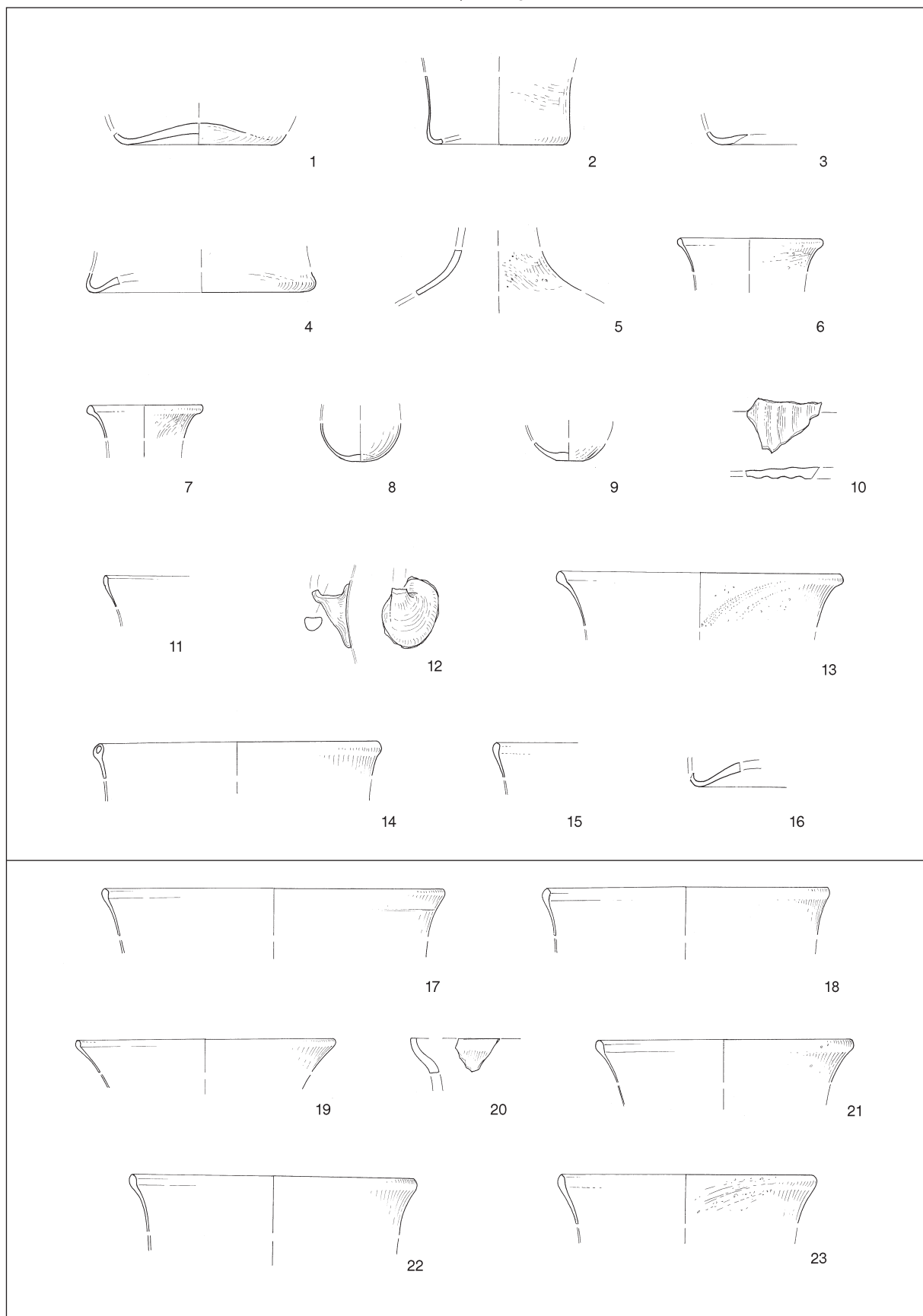

*T. 61:* Tonovcov grad, 1-16 sklop cerkva; 17-23 prostor med severno in osrednjo cerkvijo. Vse steklo. M. = 1:2.

*Pl. 61:* Tonovcov grad, 1-16 ecclesiastical complex; 17-23 the area between the north and the main church. All glass. Scale = 1:2.

TABLE / PLATES

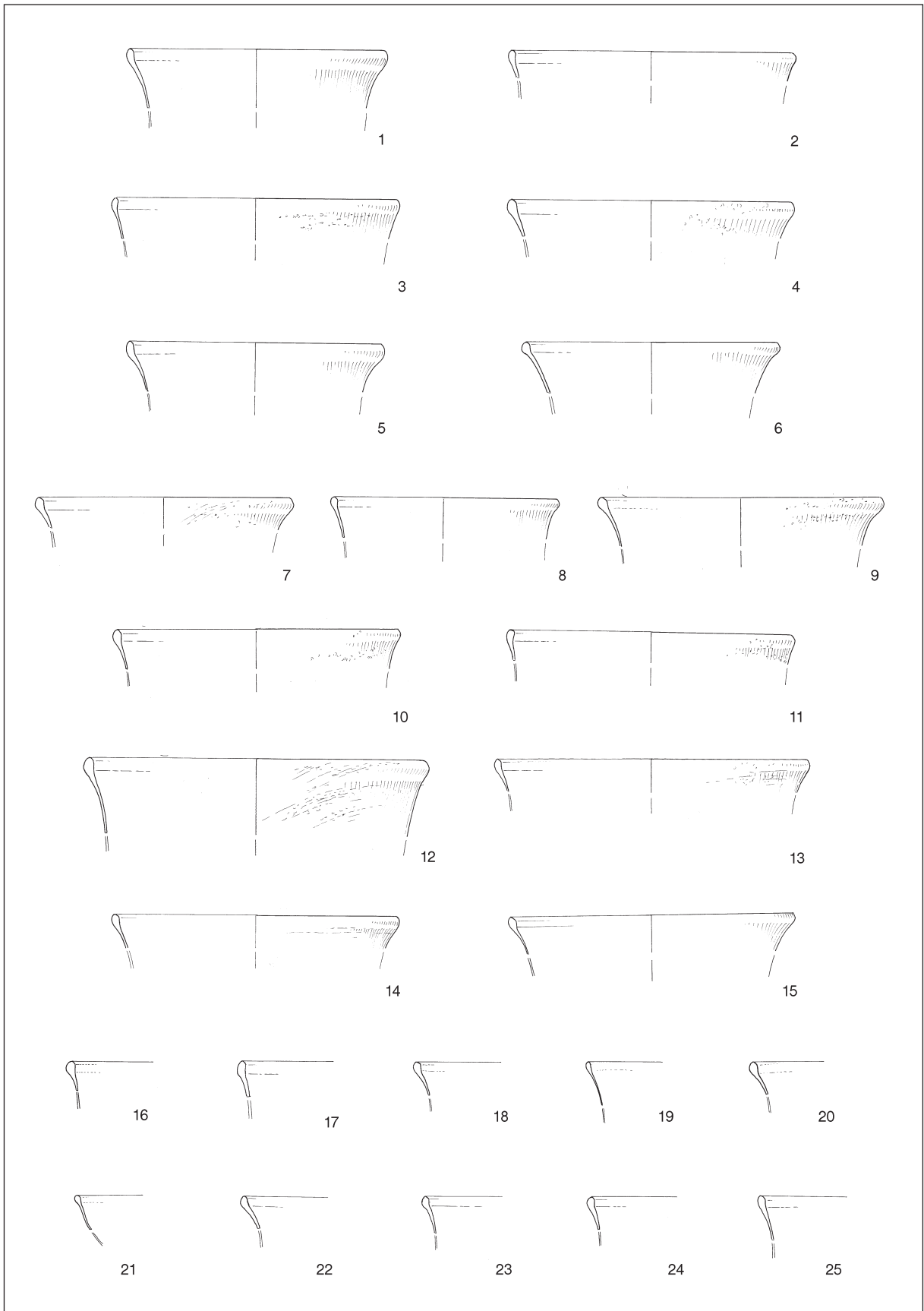

*T. 62:* Tonovcov grad, prostor med severno in osrednjo cerkvijo. Vse steklo. M. = 1:2.

*Pl. 62:* Tonovcov grad, the area between the north and the main church. All glass. Scale = 1:2.



TABLE / PLATES

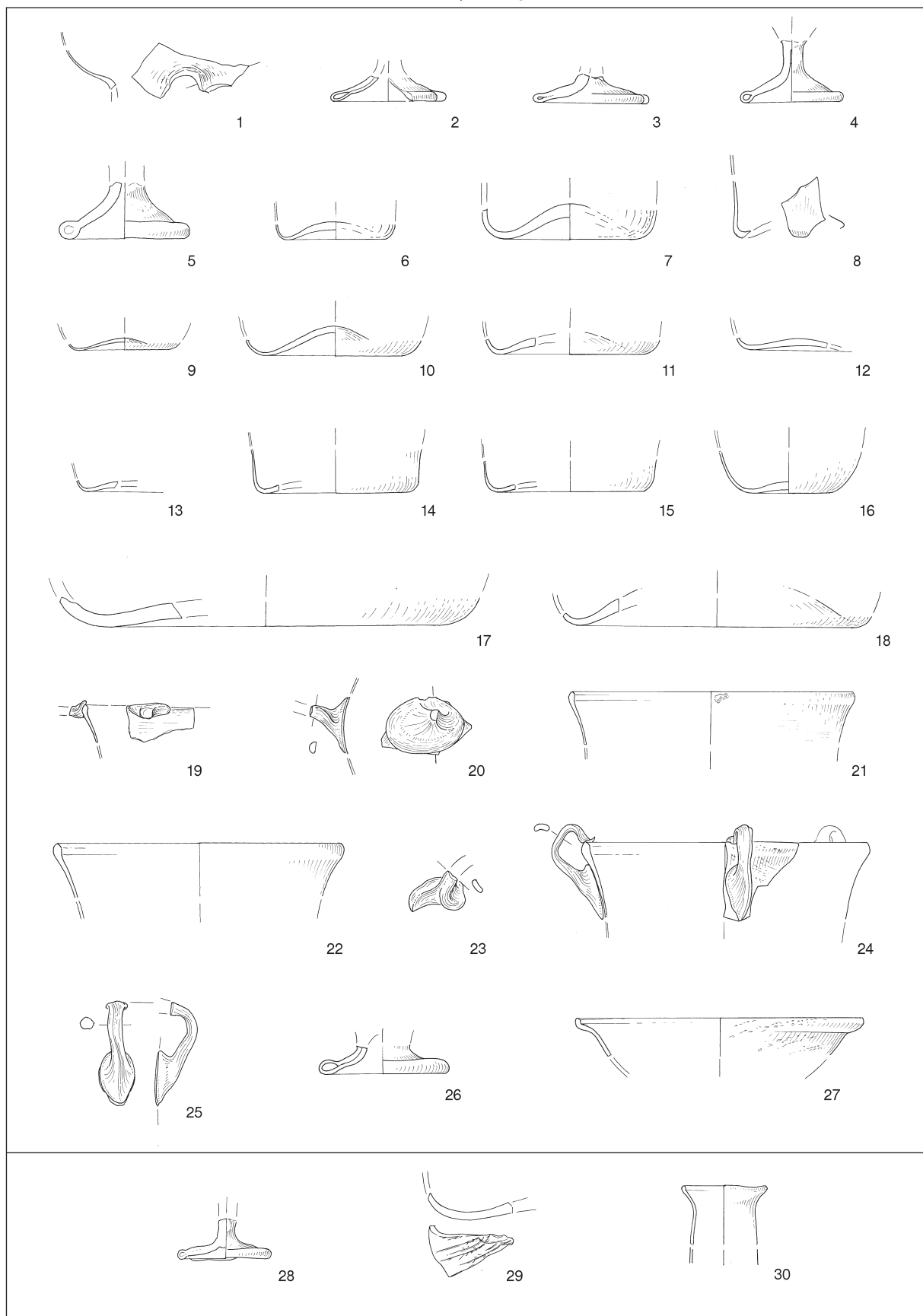

T. 63: Tonovcov grad, 1-27 prostor med severno in osrednjo cerkvijo; 28-30 cisterna. Vse steklo. M. = 1:2.

Pl. 63: Tonovcov grad, 1-27 the area between the north and the main church; 28-30 cistern. All glass. Scale = 1:2.

TABLE / PLATES

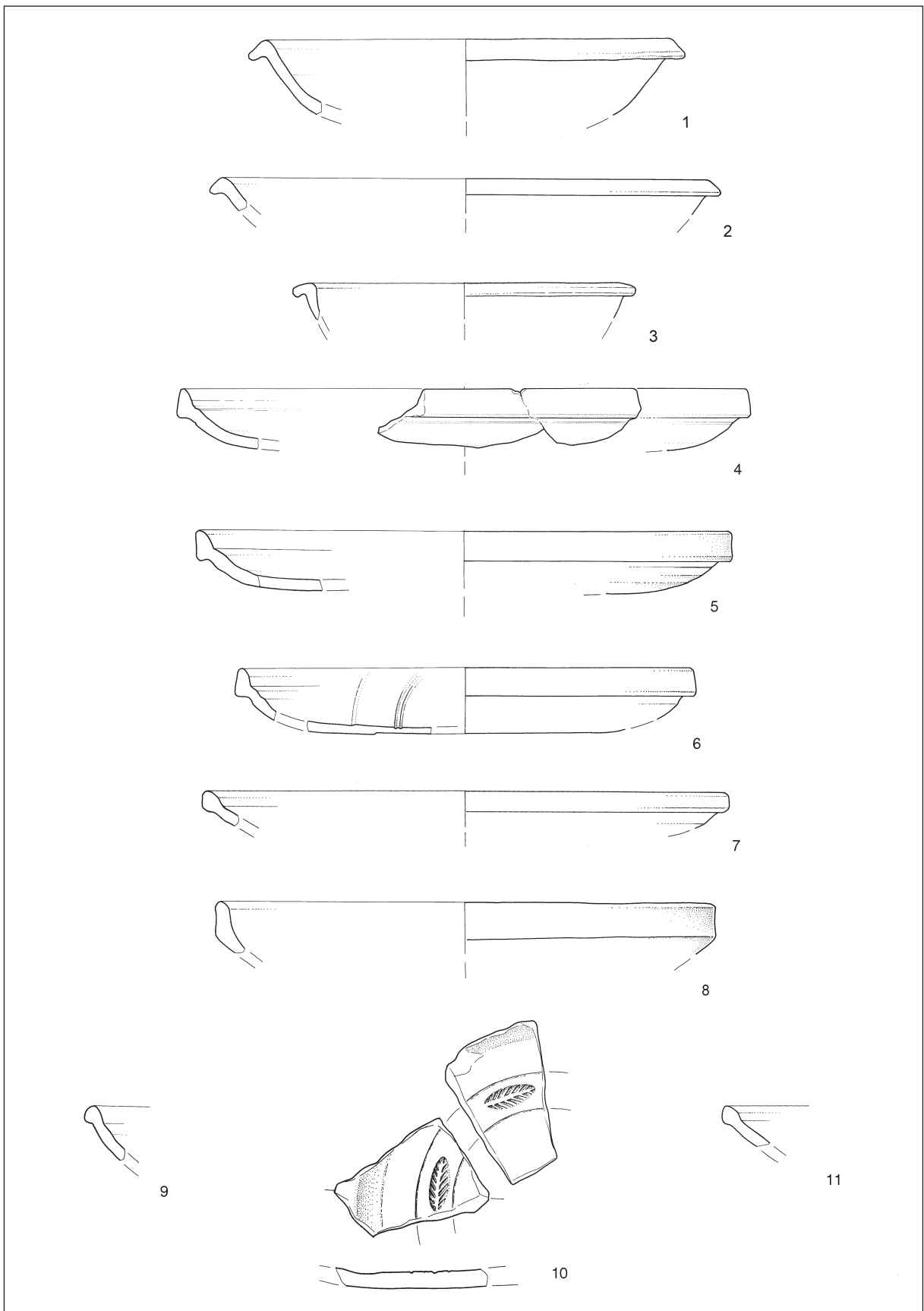

T. 64: Tonovcov grad, stavba 1. Uvožena keramika. M. = 1:3.

Pl. 64: Tonovcov grad, building 1. Imported pottery. Scale = 1:3.

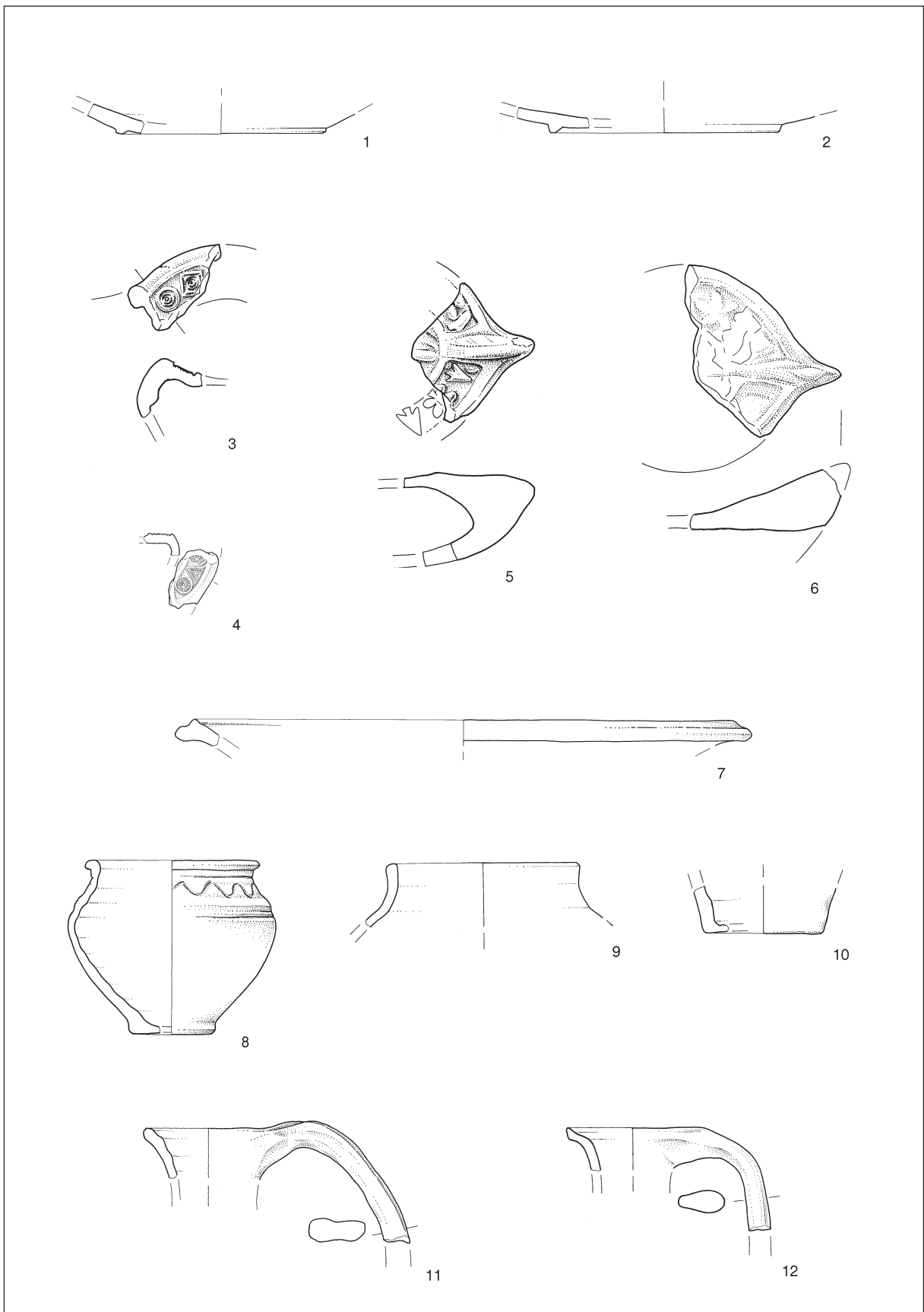

*T.* 65: Tonovcov grad, stavba 1. Uvožena keramika. M. 1,2,7-12 = 1:3; 3-6 = 1:2.

*Pl.* 65: Tonovcov grad, building 1. Imported pottery. Scale 1,2,7-12 = 1:3; 3-6 = 1:2.

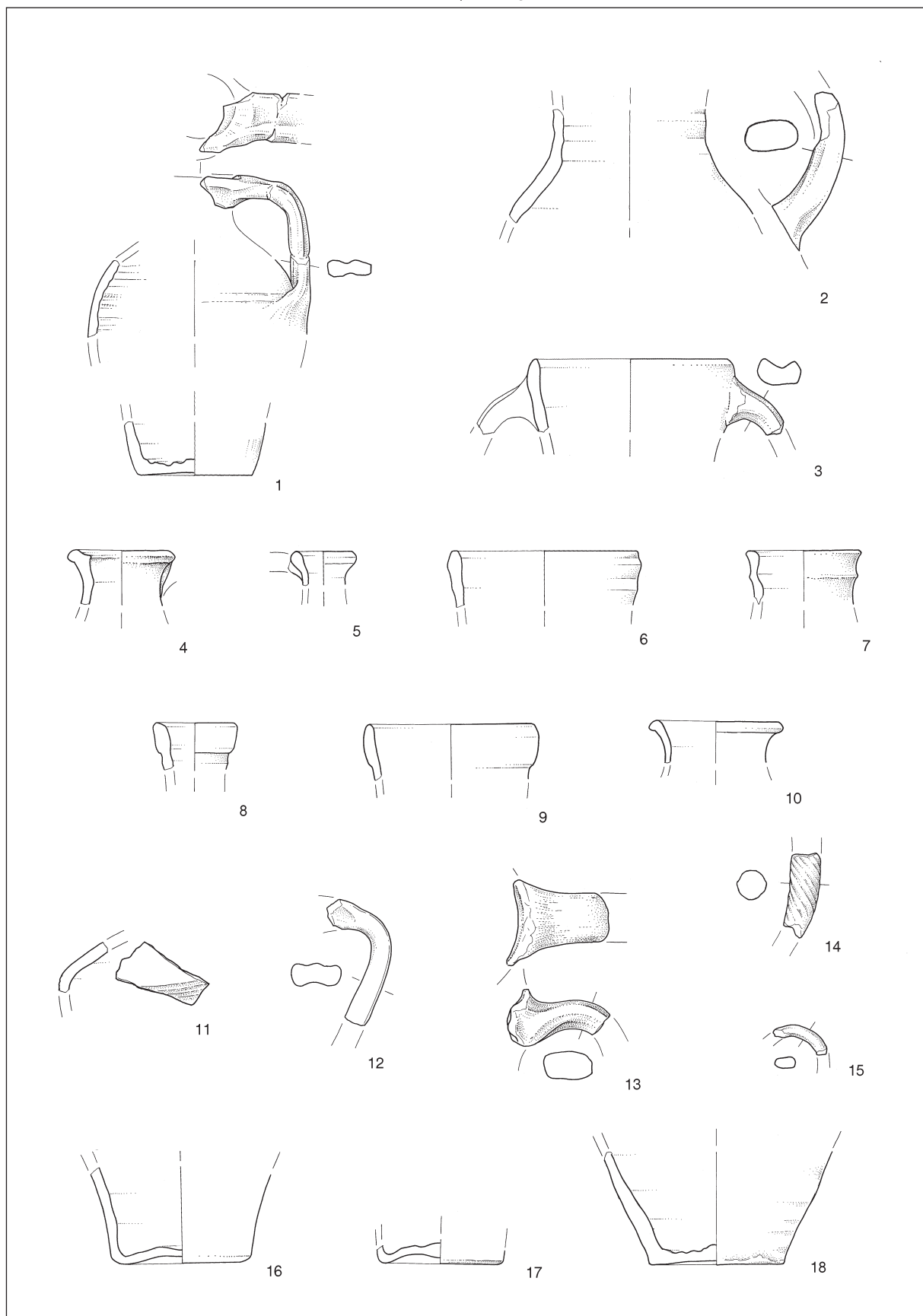

T. 66: Tonovcov grad, stavba 1. Uvožena keramika. M. = 1:3.

Pl. 66: Tonovcov grad, building 1. Imported pottery. Scale = 1:3.

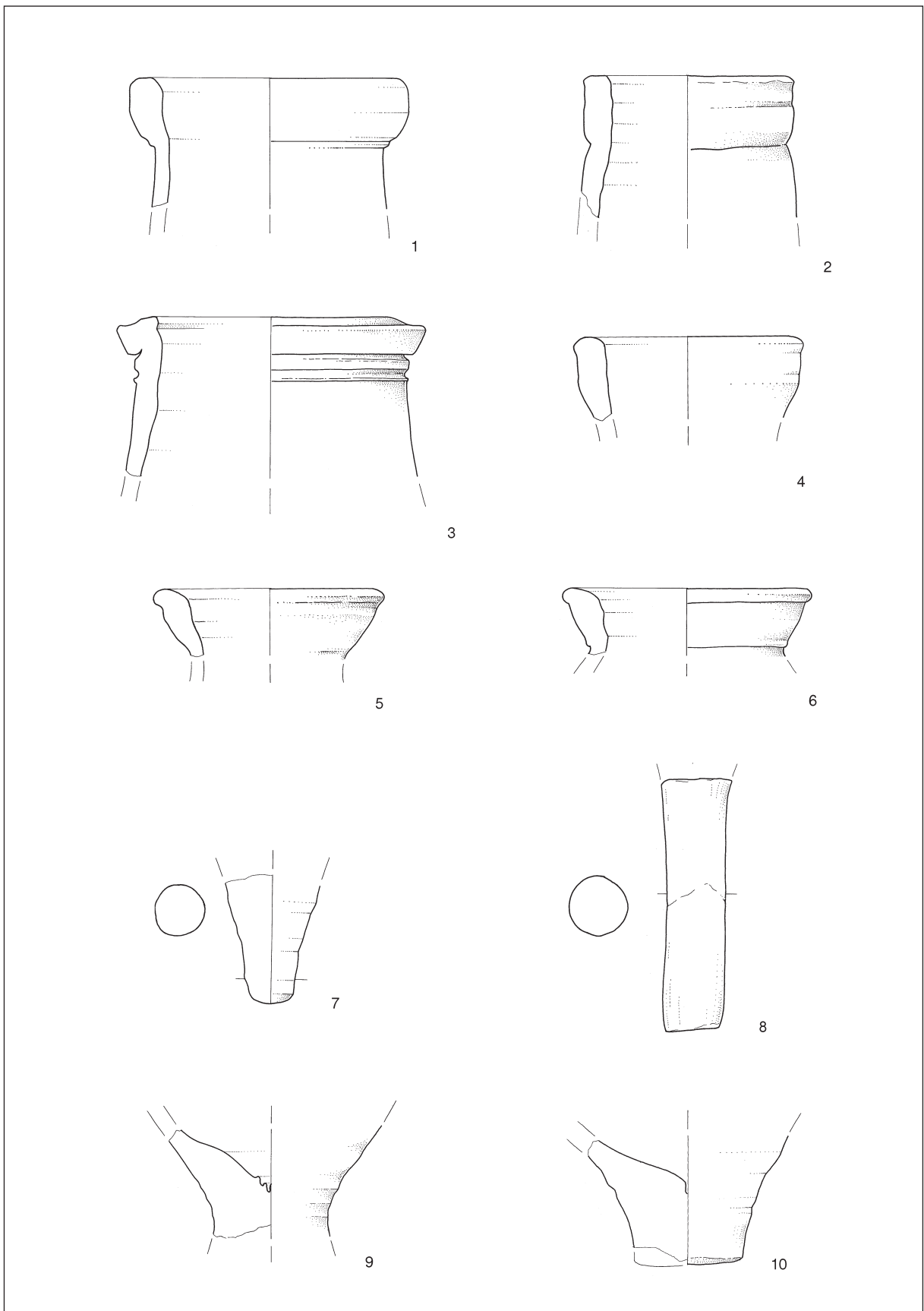

T. 67: Tonovcov grad, stavba 1. Uvožena keramika. M. = 1:3.

Pl. 67: Tonovcov grad, building 1. Imported pottery. Scale = 1:3.

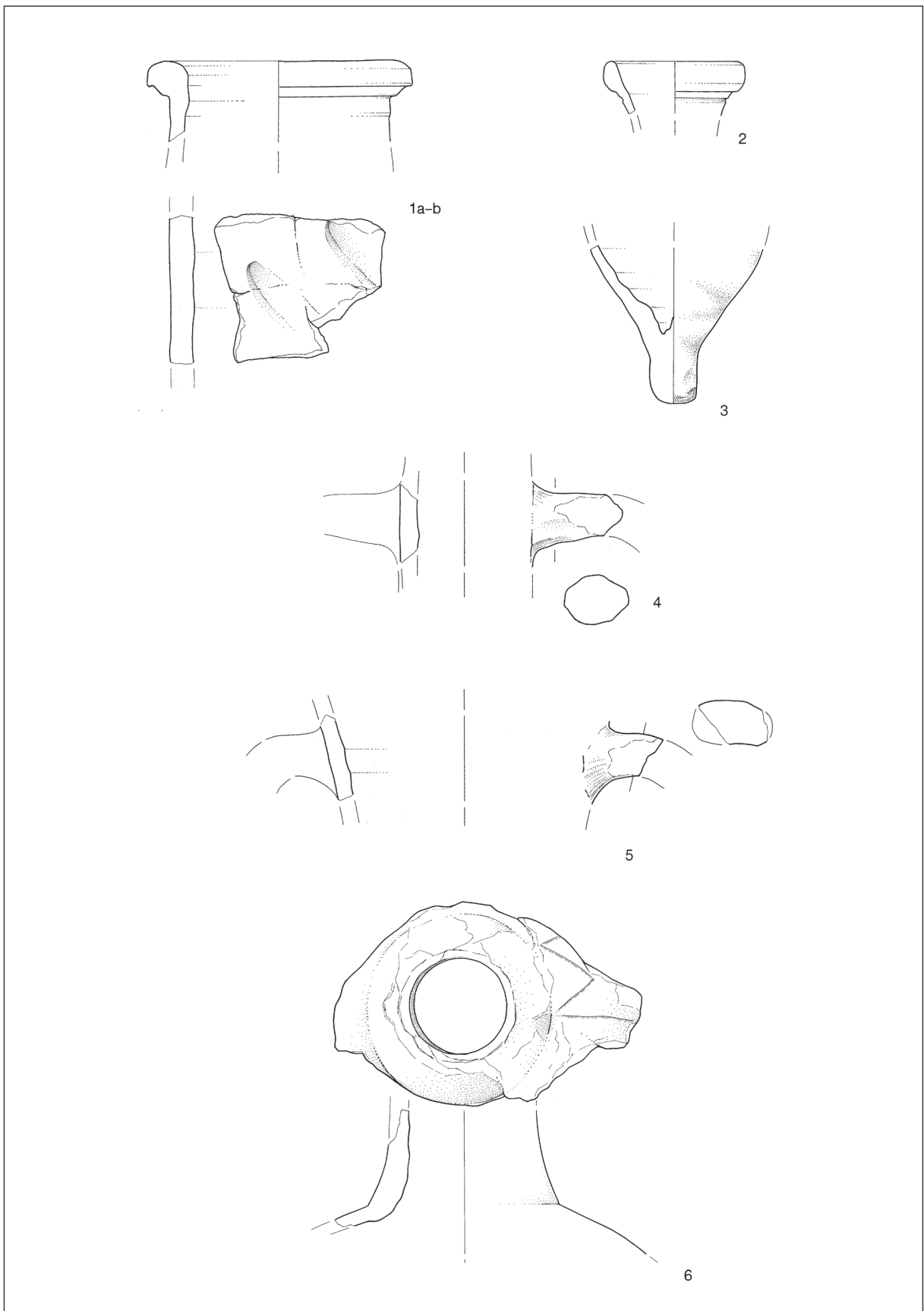

*T. 68:* Tonovcov grad, stavba 1. Uvožena keramika. M. = 1:3.

*Pl. 68:* Tonovcov grad, building 1. Imported pottery. Scale = 1:3.

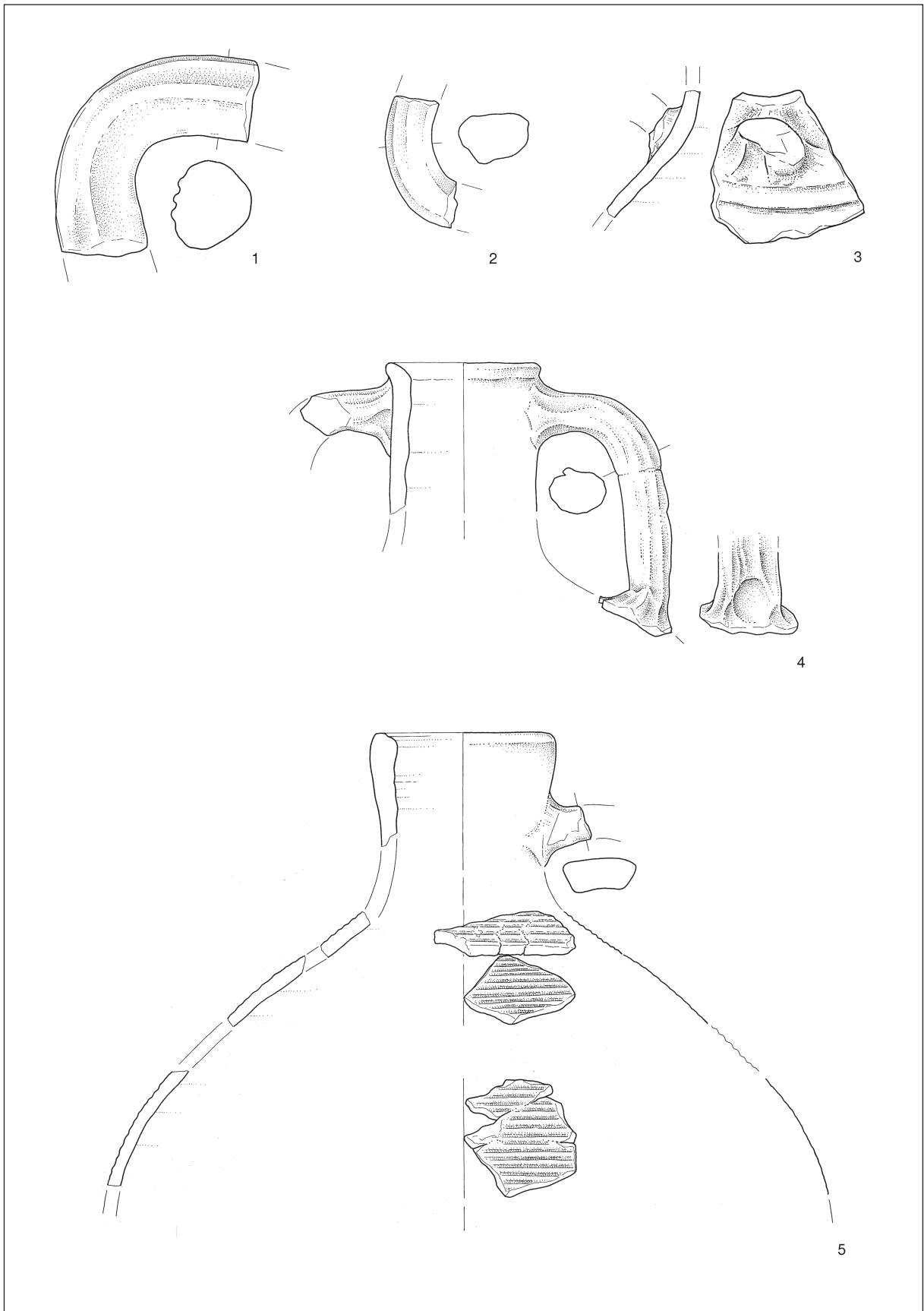

T. 69: Tonovcov grad, stavba 1. Uvožena keramika. M. = 1:3.

Pl. 69: Tonovcov grad, building 1. Imported pottery. Scale = 1:3.

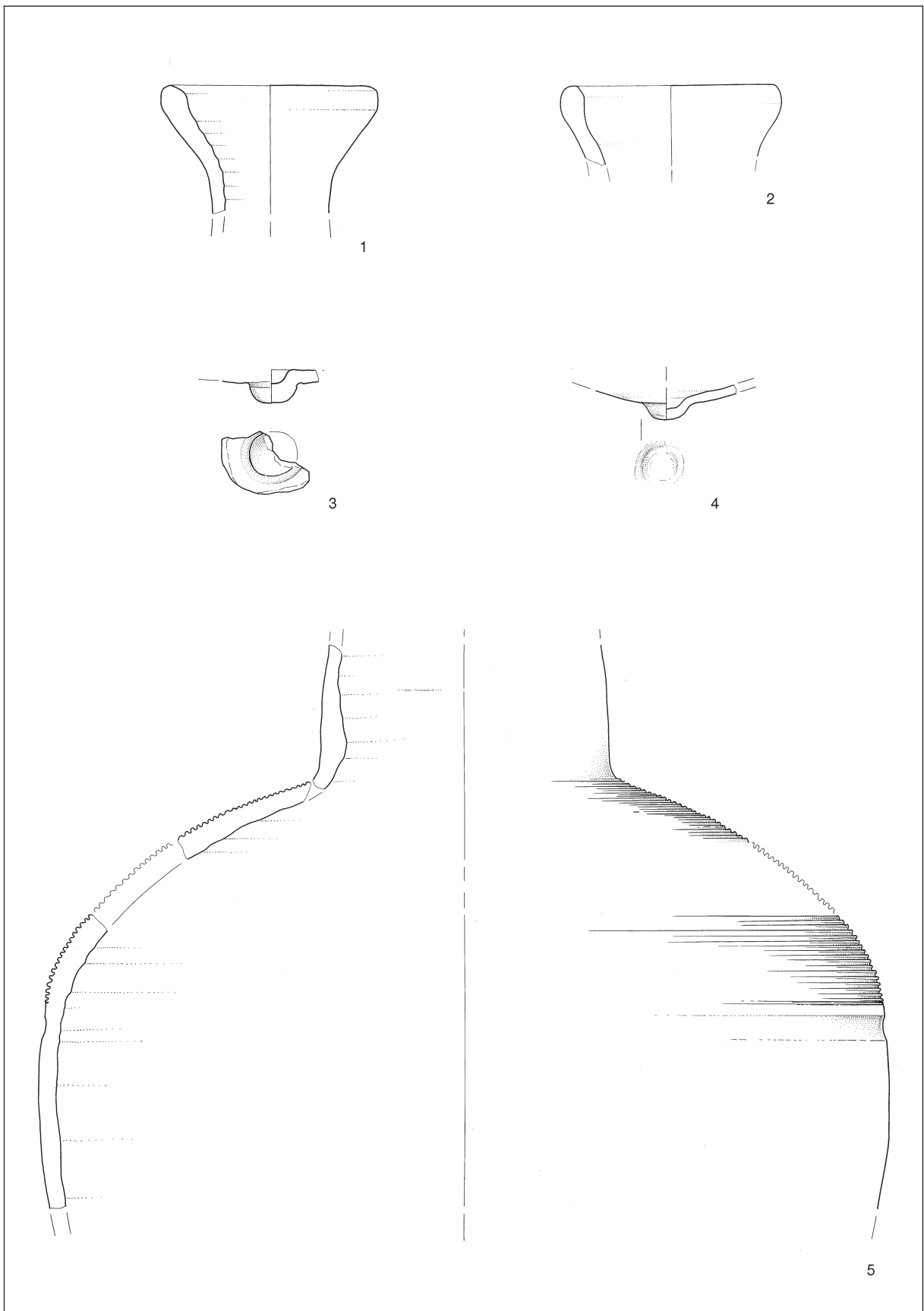

*T. 70:* Tonovcov grad, stavba 1. Uvožena keramika. M. = 1:3.

*Pl. 70:* Tonovcov grad, building 1. Imported pottery. Scale = 1:3.



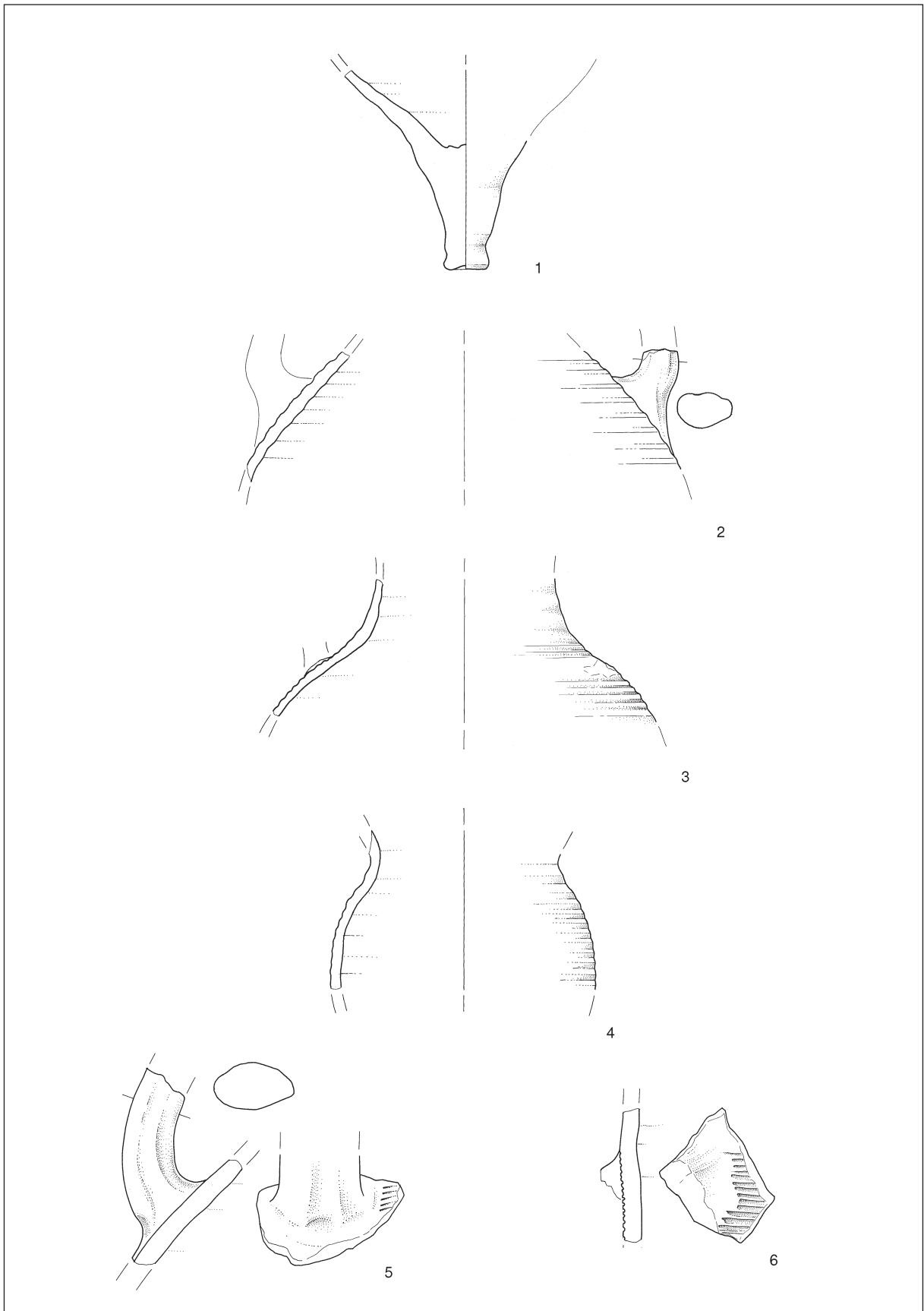

*T. 71:* Tonovcov grad, stavba 1. Uvožena keramika. M. = 1:3.

*Pl. 71:* Tonovcov grad, building 1. Imported pottery. Scale = 1:3.

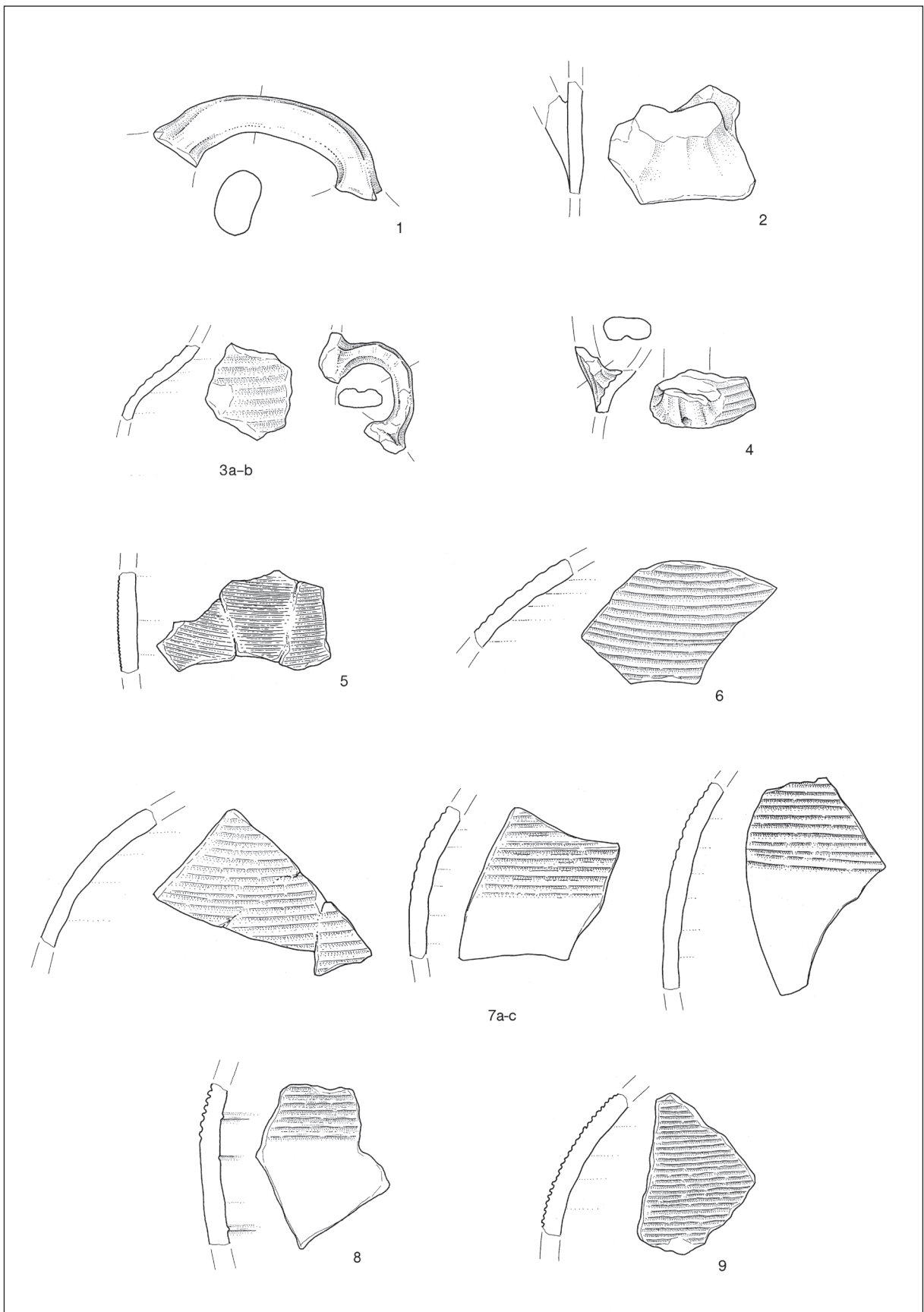

T. 72: Tonovcov grad, stavba 1. Uvožena keramika. M. = 1:3.

Pl. 72: Tonovcov grad, building 1. Imported pottery. Scale = 1:3.

TABLE / PLATES

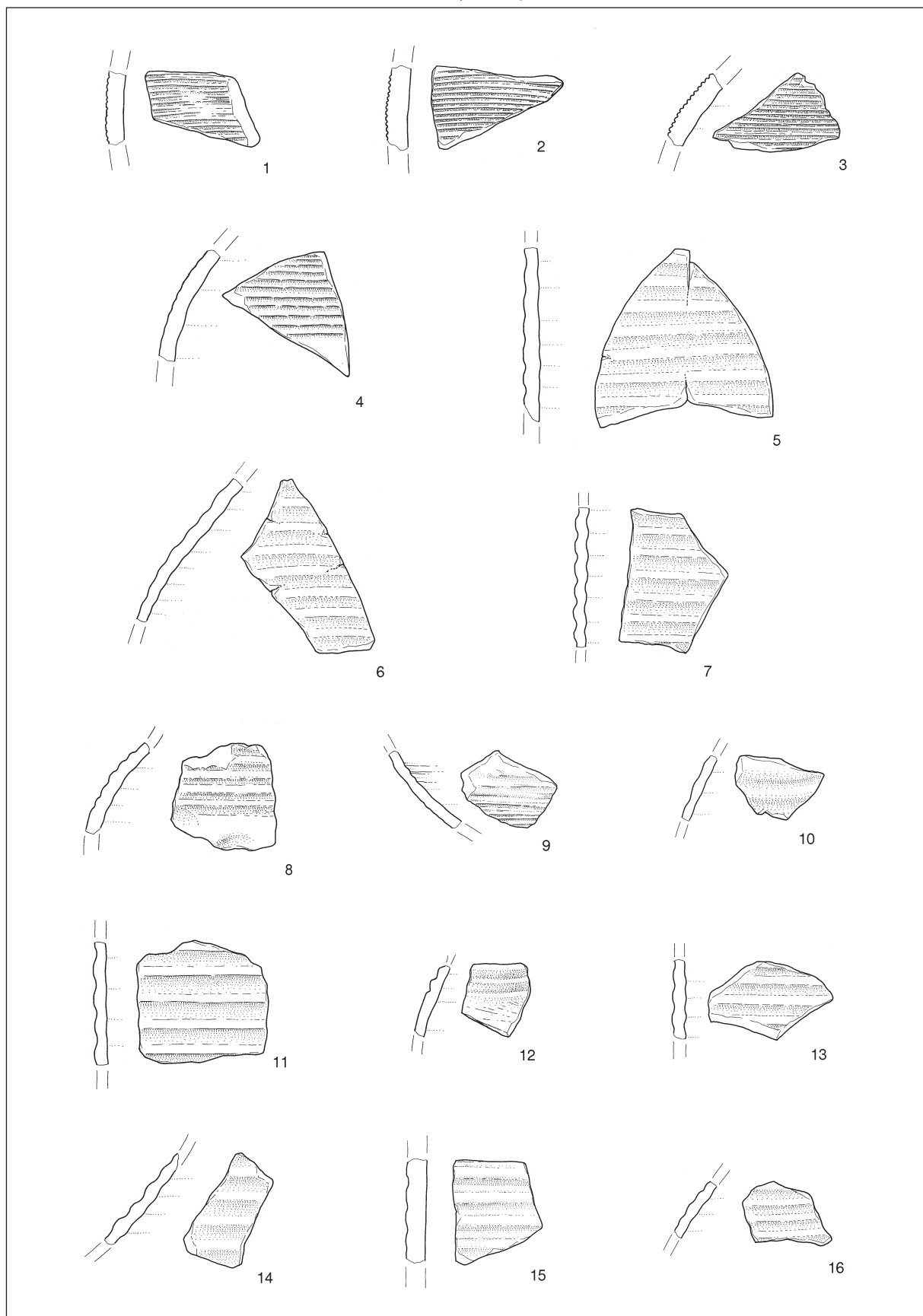

T. 73: Tonovcov grad, stavba 1. Uvožena keramika. M. = 1:3.

Pl. 73: Tonovcov grad, building 1. Imported pottery. Scale = 1:3.

TABLE / PLATES

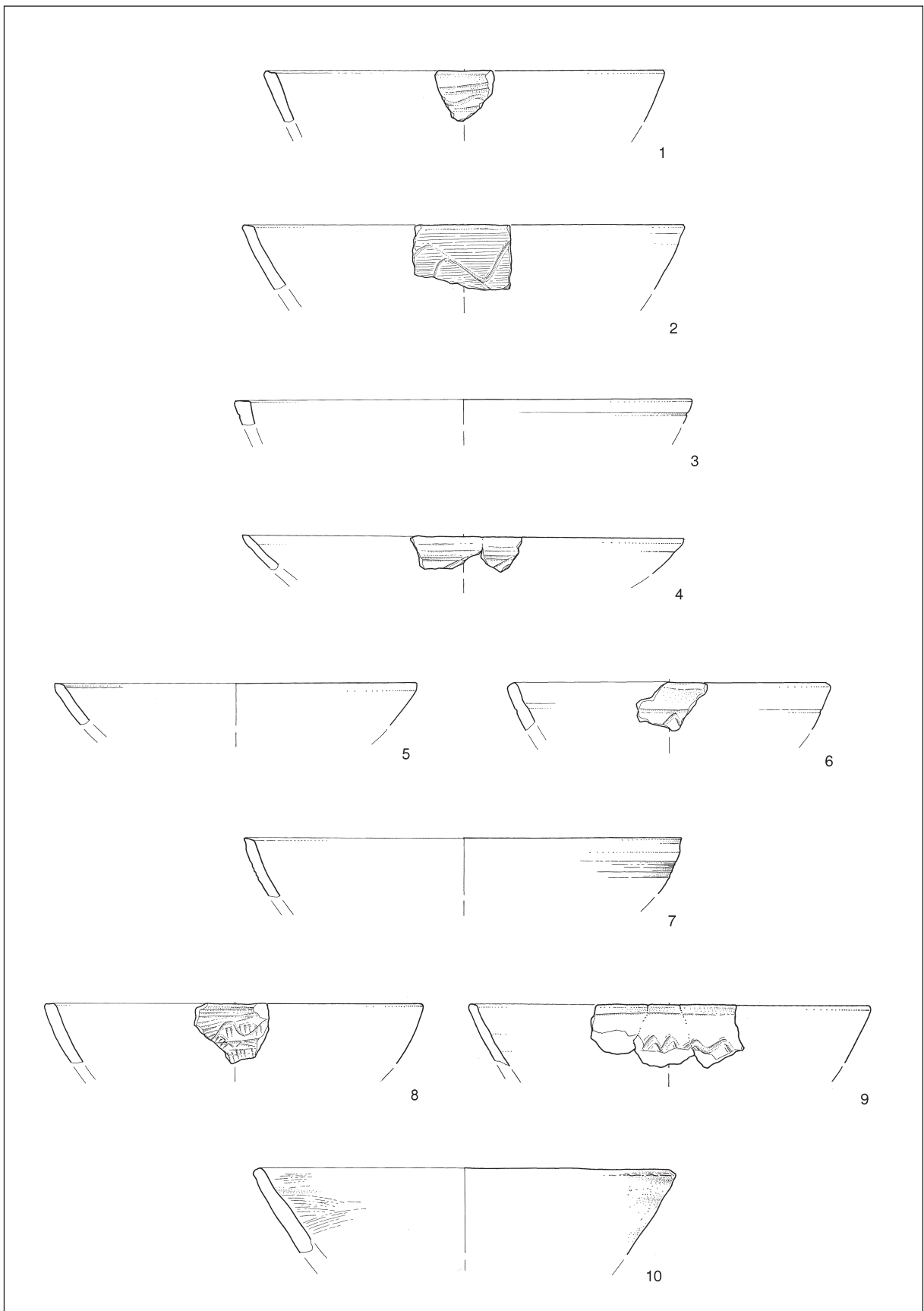

T. 74: Tonovcov grad, stavba 1. Groba keramika – sklede, tip 1. M. = 1:3.  
 Pl. 74: Tonovcov grad, building 1. Coarse ware – bowls, type 1. Scale = 1:3.

TABLE / PLATES

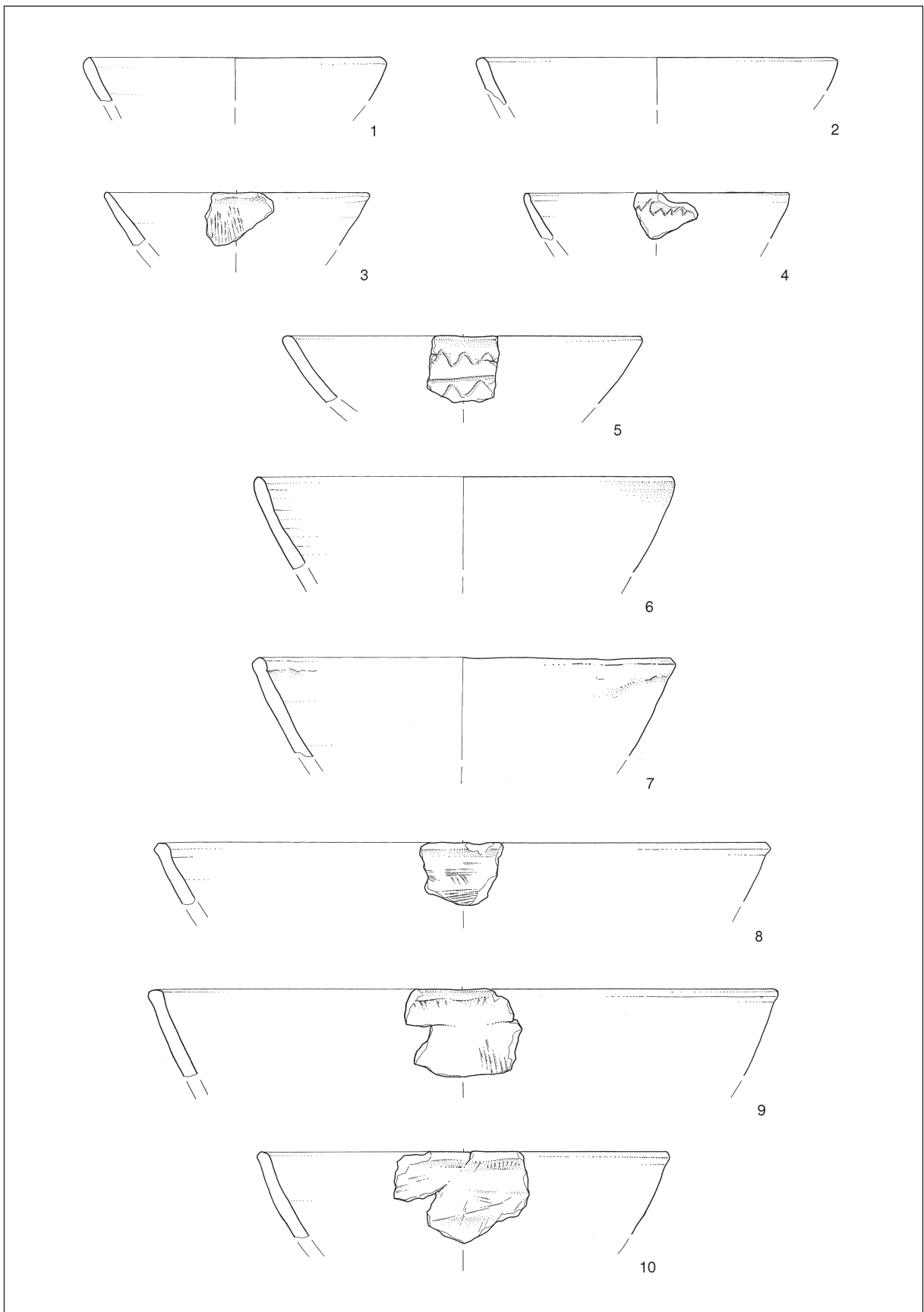

*T. 75:* Tonovcov grad, stavba 1. Groba keramika – sklede, tip 1. M. = 1:3.

*Pl. 75:* Tonovcov grad, building 1. Coarse ware – bowls, type 1. Scale = 1:3.

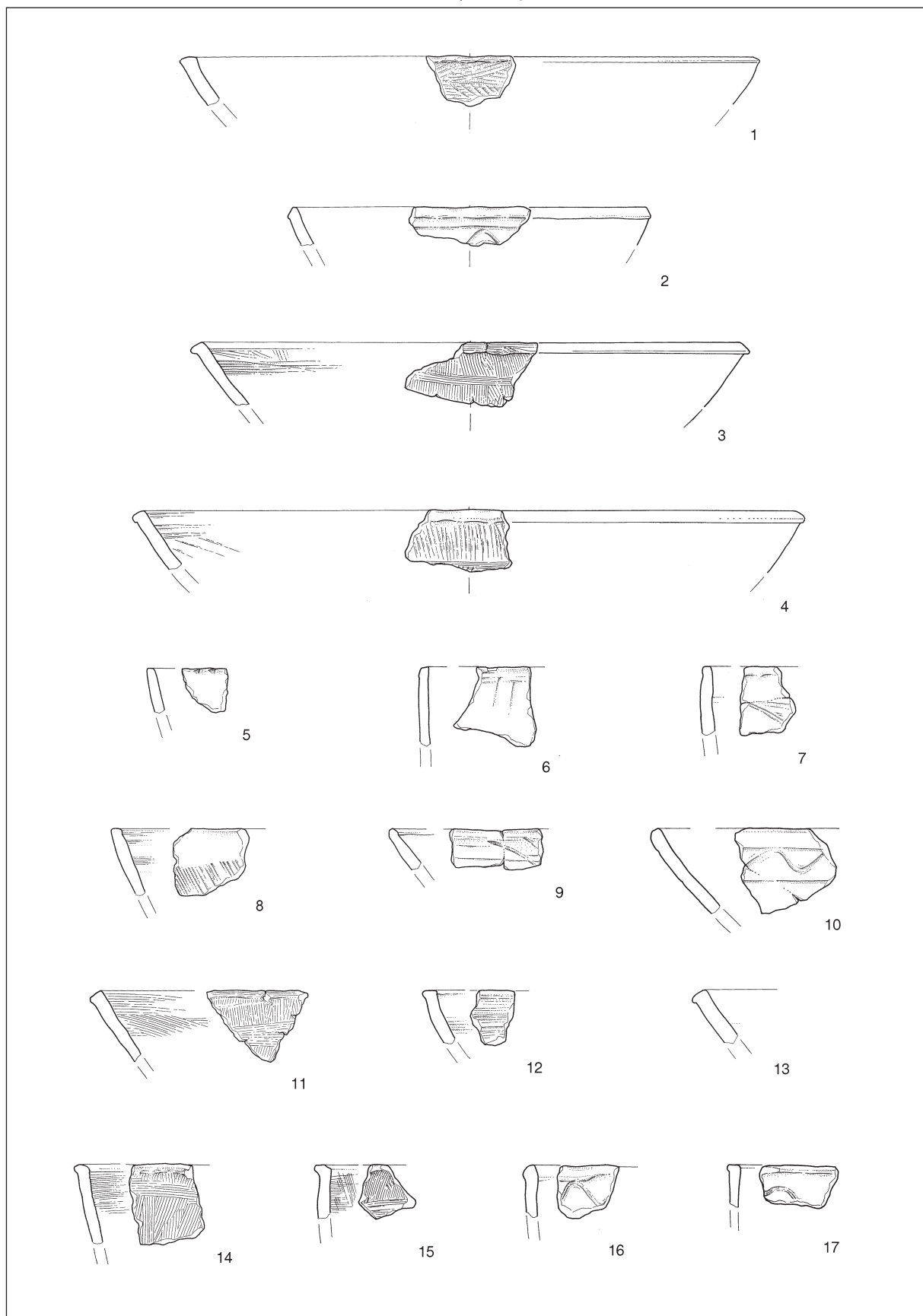

T. 76: Tonovcov grad, stavba 1. Groba keramika – sklede, tip 1. M. = 1:3.  
 Pl. 76: Tonovcov grad, building 1. Coarse ware – bowls, type 1. Scale = 1:3.

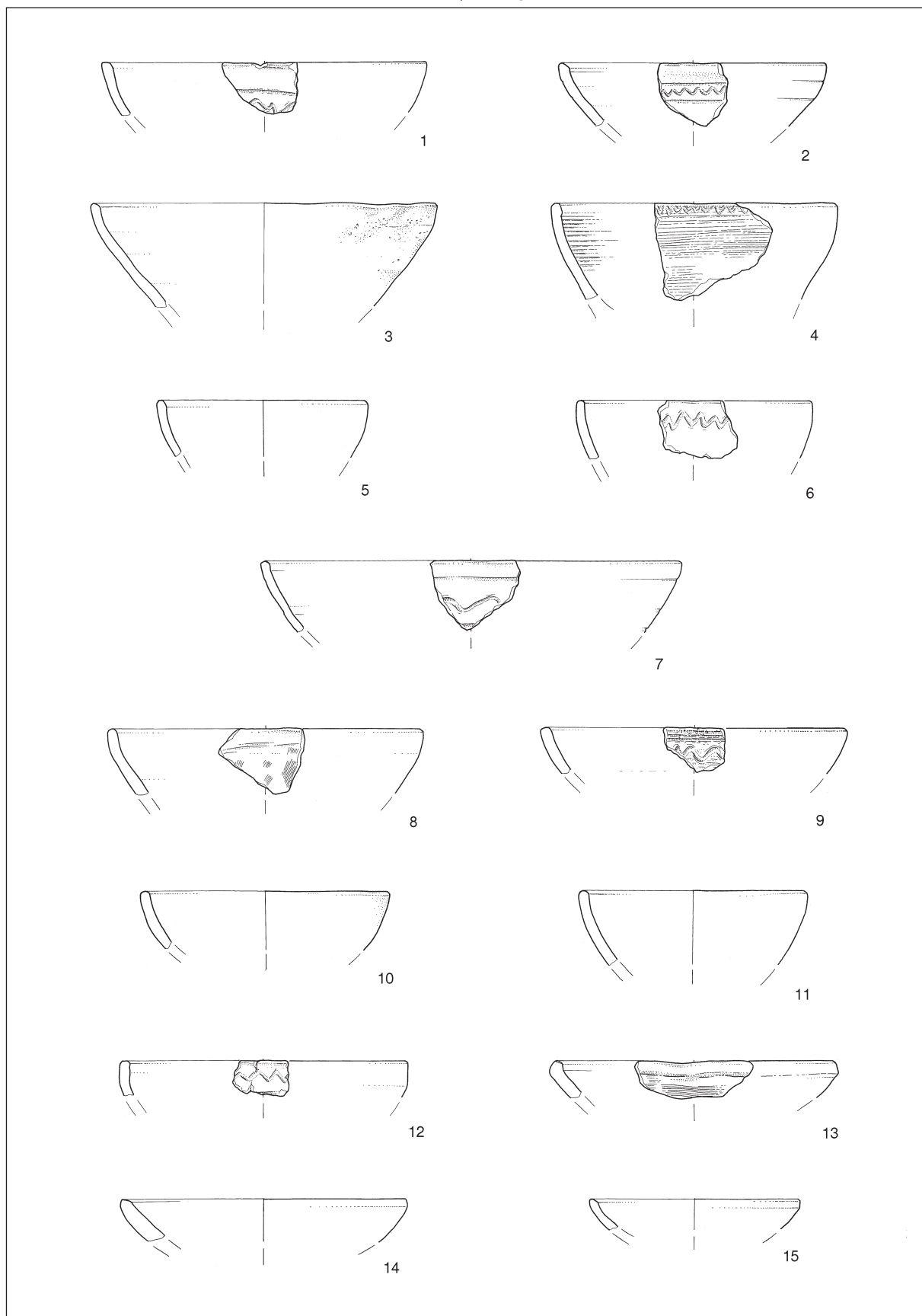

*T. 77:* Tonovcov grad, stavba 1. Groba keramika – sklede, tip 2. M. = 1:3.

*Pl. 77:* Tonovcov grad, building 1. Coarse ware – bowls, type 2. Scale = 1:3.

TABLE / PLATES

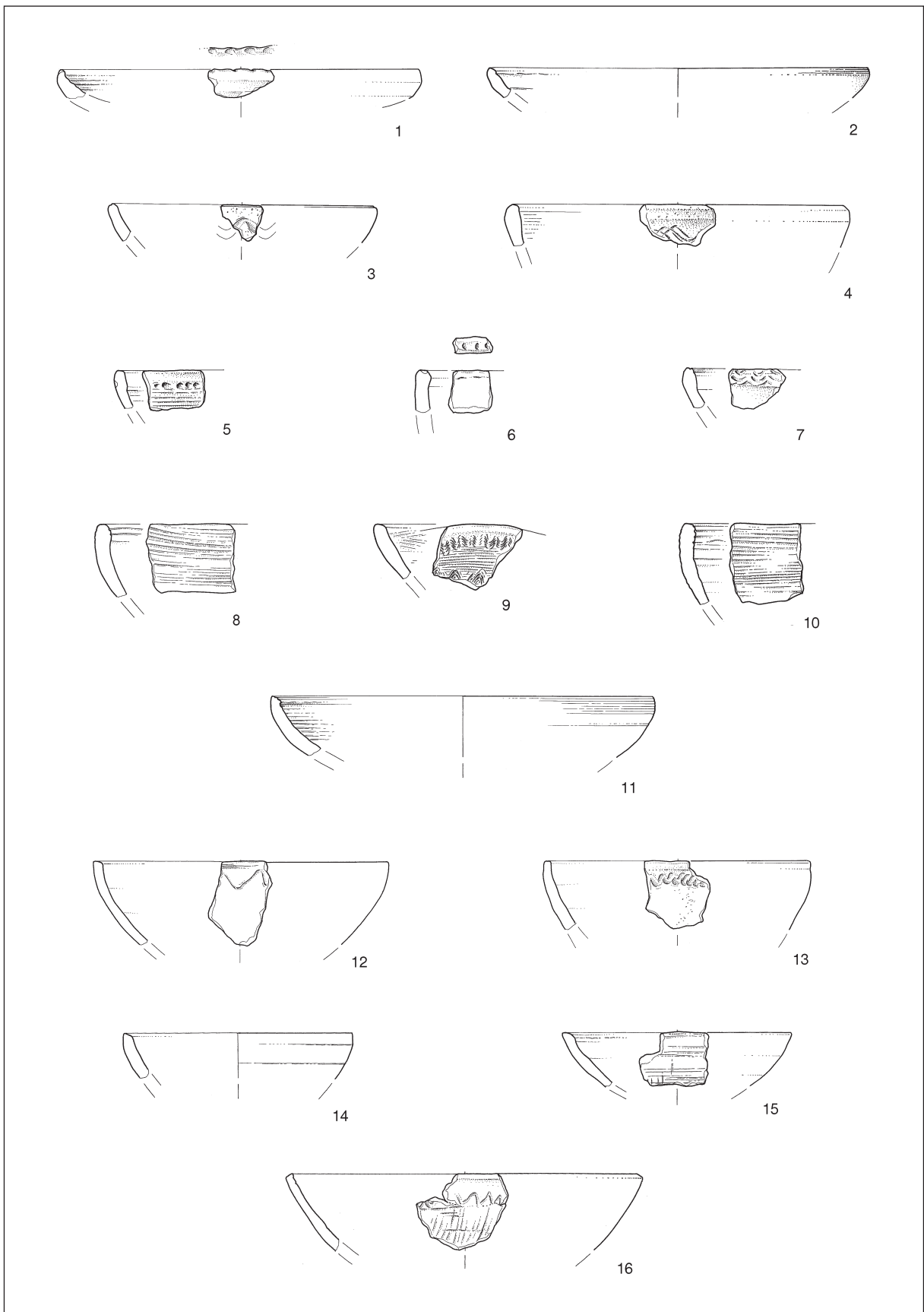

T. 78: Tonovcov grad, stavba 1. Groba keramika – sklede, tip 2. M. = 1:3.

Pl. 78: Tonovcov grad, building 1. Coarse ware – bowls, type 2. Scale = 1:3.



TABLE / PLATES

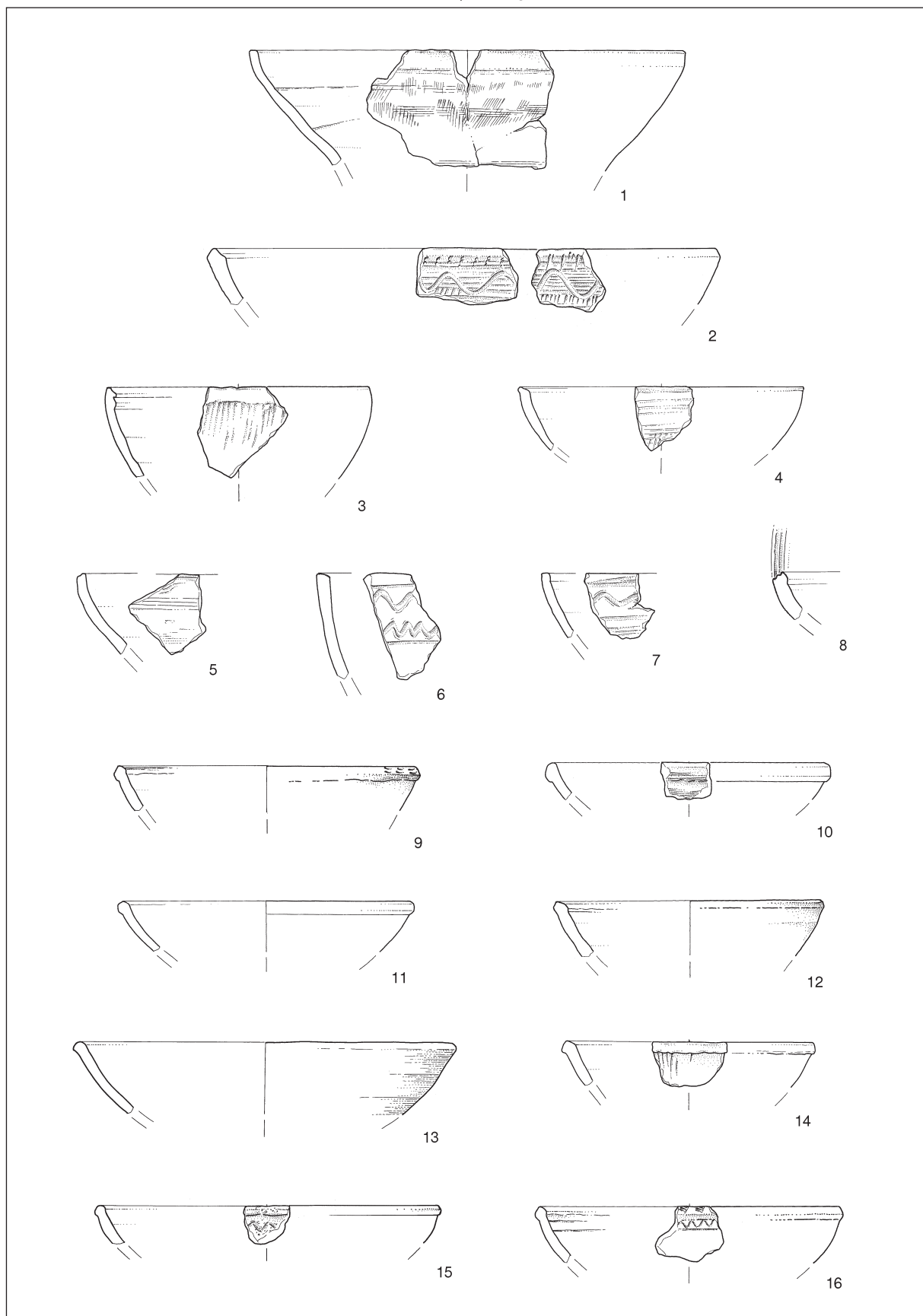

*T. 79:* Tonovcov grad, stavba 1. Groba keramika – sklede. 1–8 tip 2; 9–16: tip 3. M. = 1:3.

*Pl. 79:* Tonovcov grad, building 1. Coarse ware – bowls. 1–8 type 2; 9–16 type 3. Scale = 1:3.

TABLE / PLATES

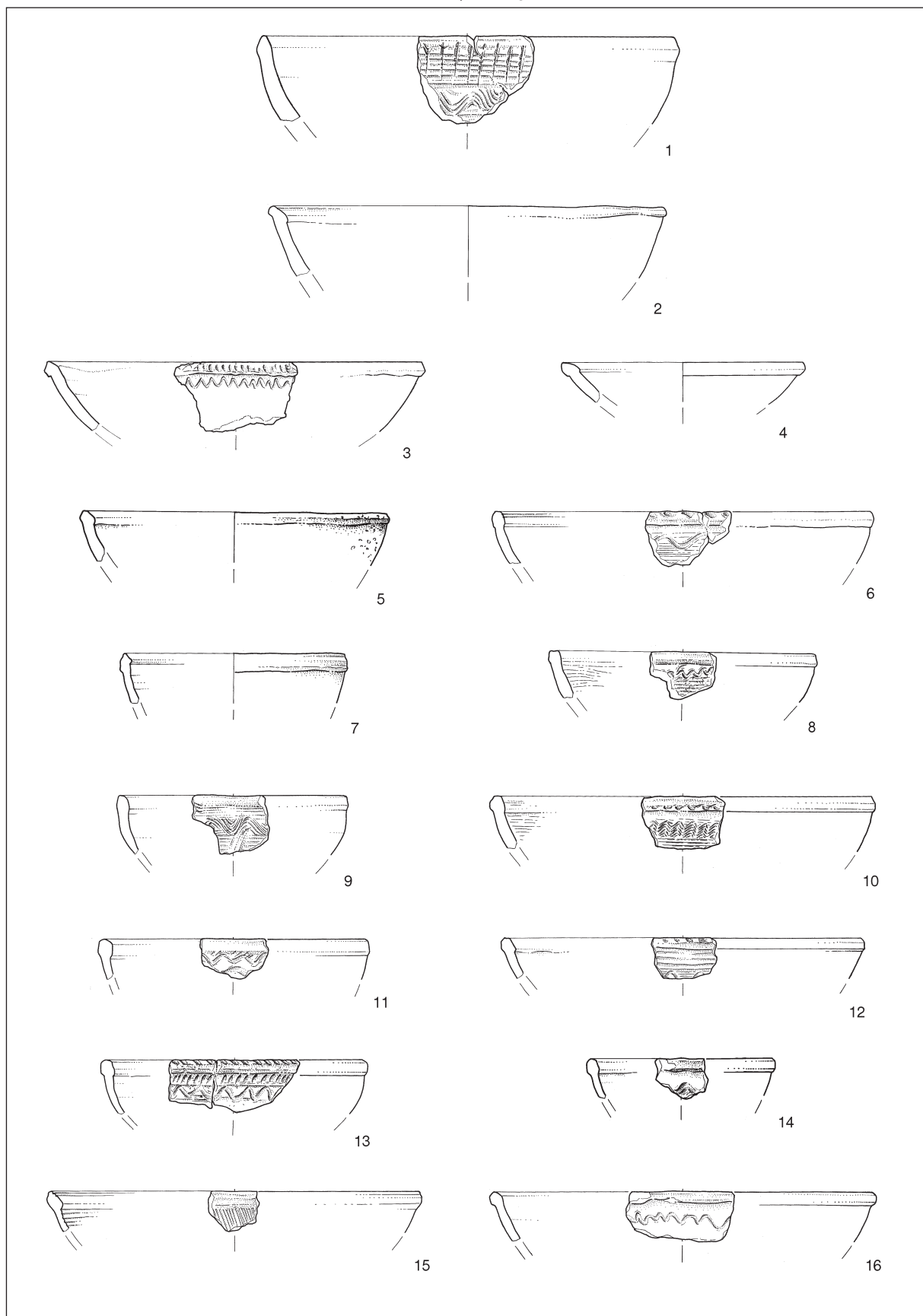

*T. 80:* Tonovcov grad, stavba 1. Groba keramika – sklede, tip 3. M. = 1:3.  
*Pl. 80:* Tonovcov grad, building 1. Coarse ware – bowls, type 3. Scale = 1:3.

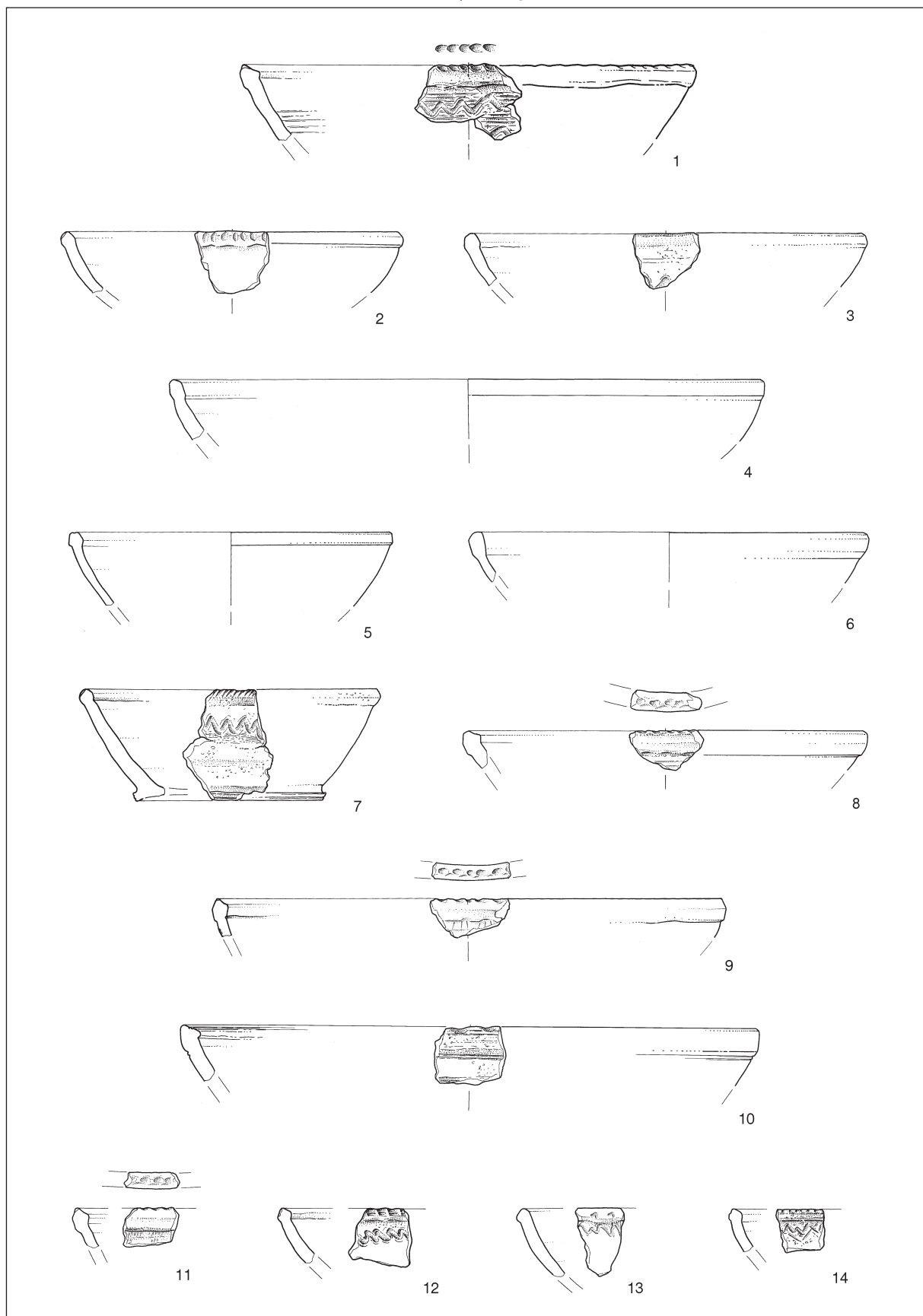

T. 81: Tonovcov grad, stavba 1. Groba keramika – sklede, tip 3. M. = 1:3.  
 Pl. 81: Tonovcov grad, building 1. Coarse ware – bowls, type 3. Scale = 1:3.

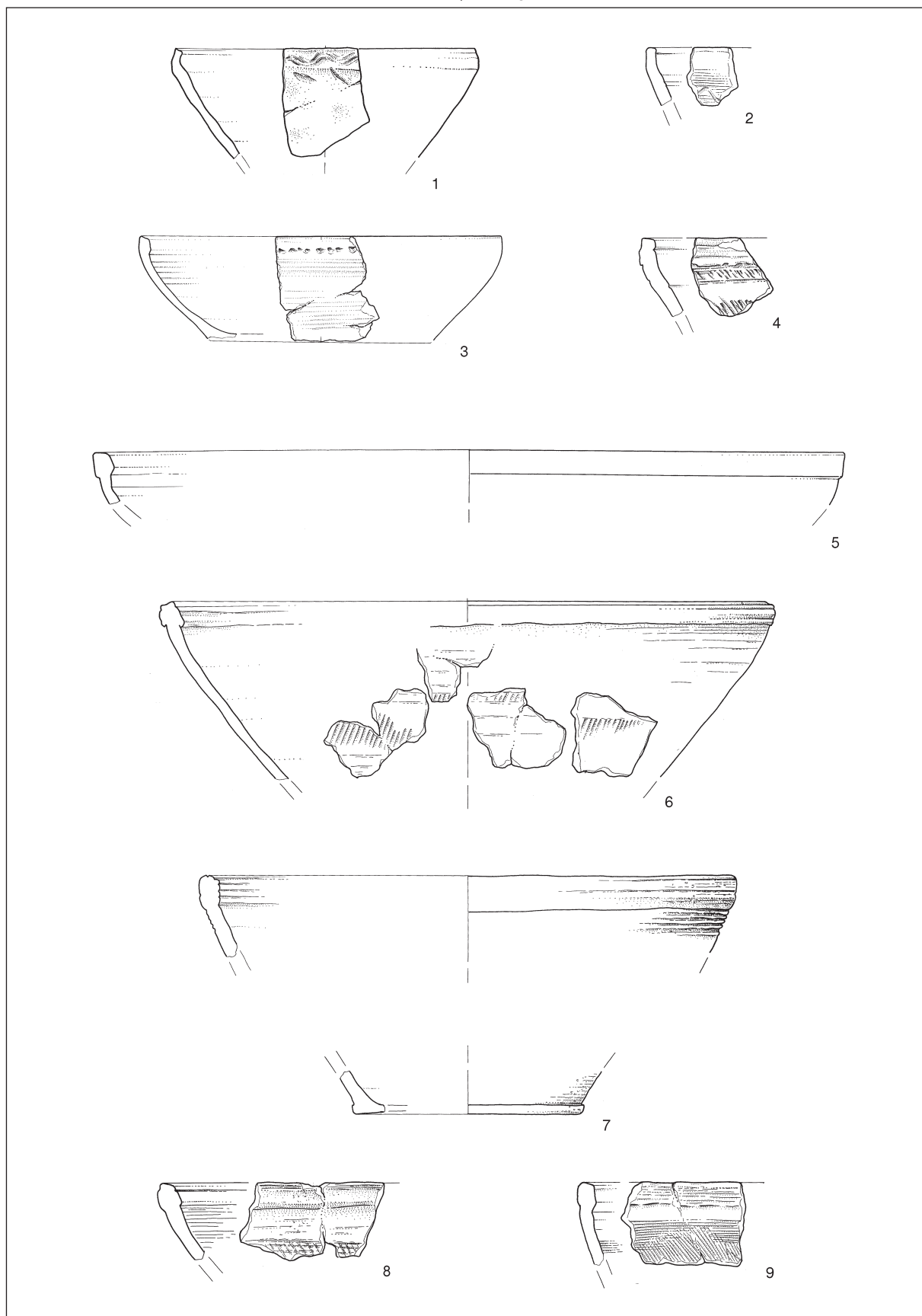

*T. 82:* Tonovcov grad, stavba 1. Groba keramika – sklede. 1-4 tip 4; 5-9 tip 5. M. = 1:3.

*Pl. 82:* Tonovcov grad, building 1. Coarse ware – bowls. 1-4 type 3; 5-9 type 4. Scale = 1:3.

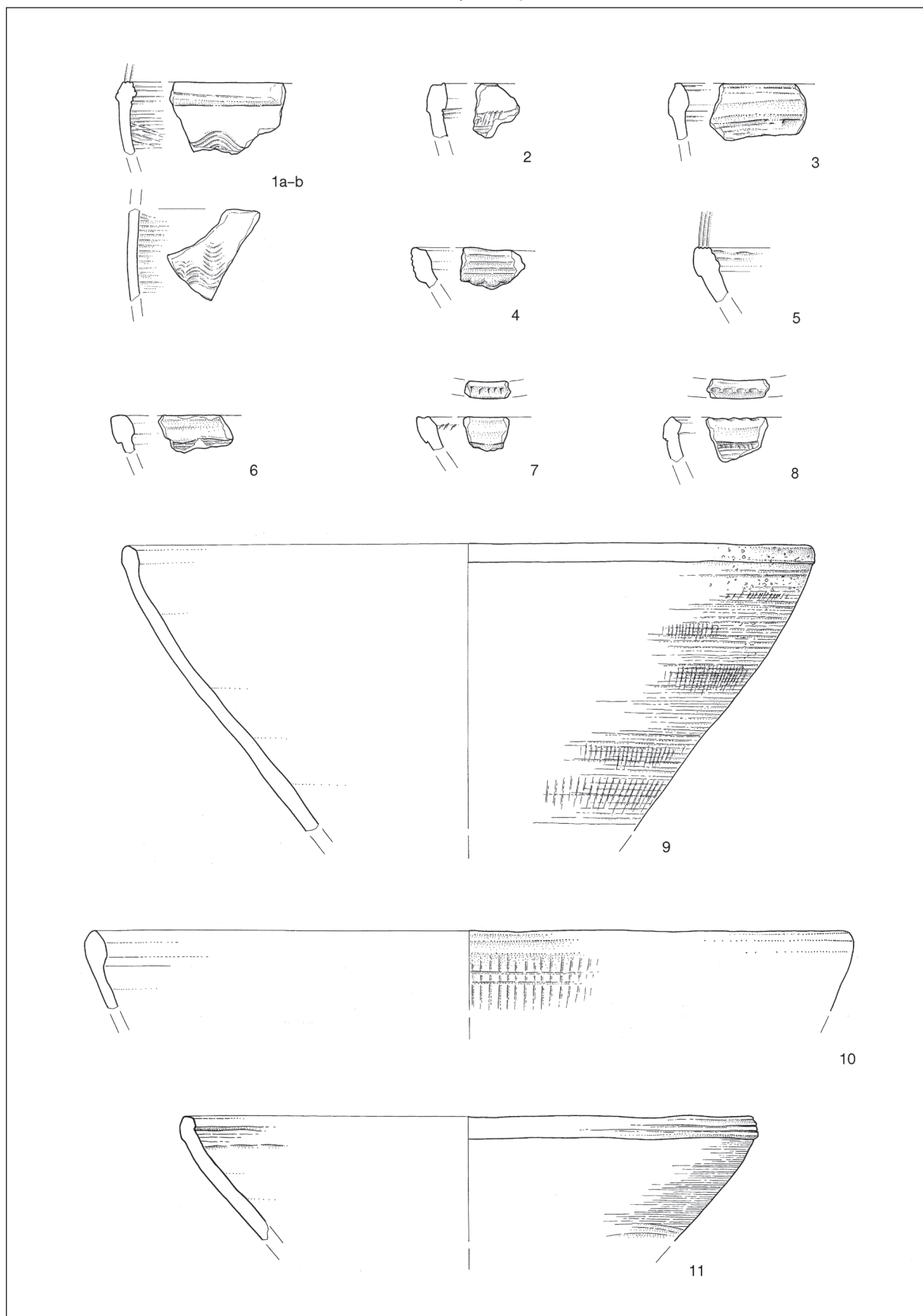

T. 83: Tonovcov grad, stavba 1. Groba keramika – sklede, tip 5. M. = 1:3.  
 Pl. 83: Tonovcov grad, building 1. Coarse ware – bowls, type 5. Scale = 1:3.

TABLE / PLATES

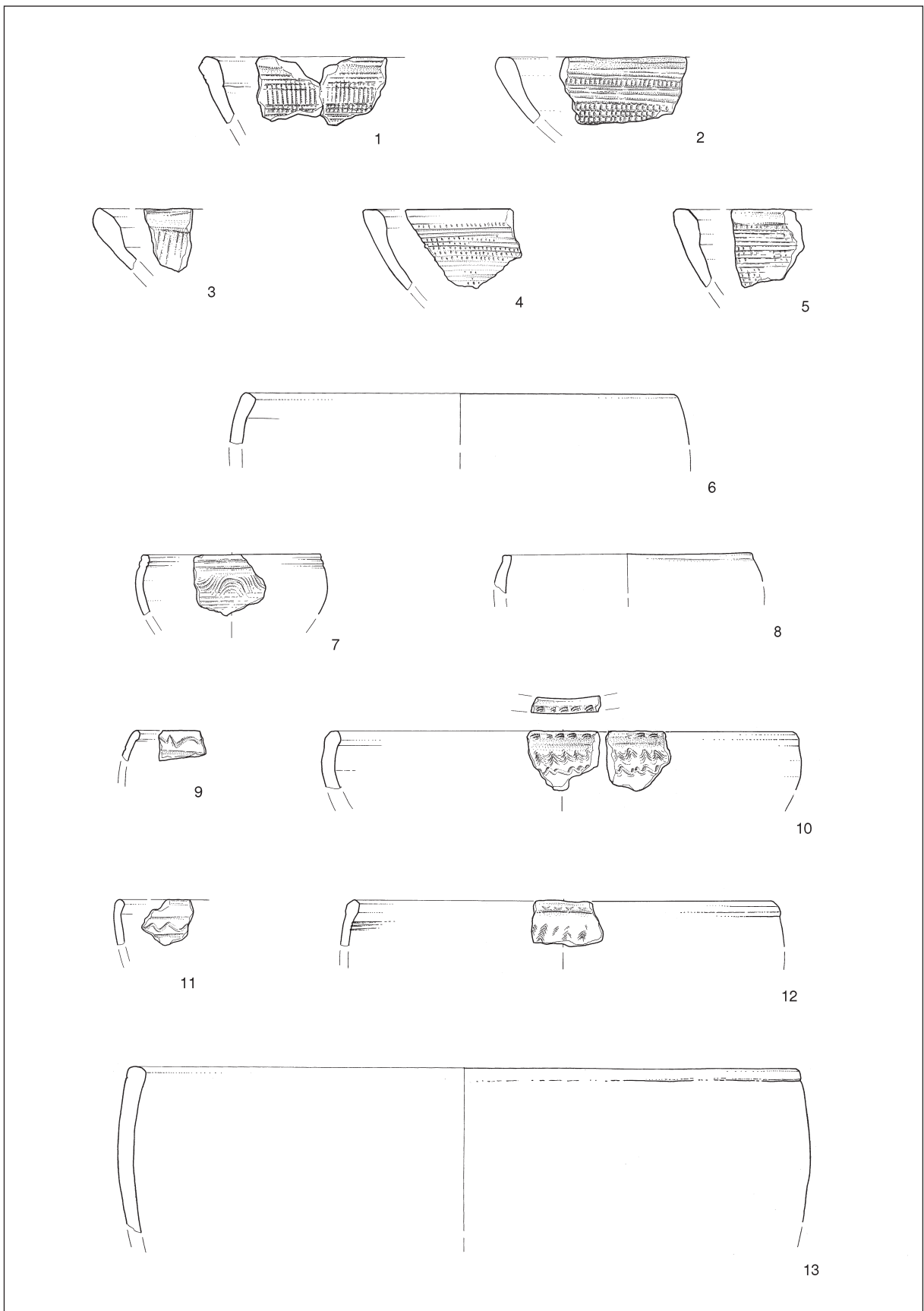

*T. 84:* Tonovcov grad, stavba 1. Groba keramika – skleda. 1–5 tip 5; 6–13 tip 6. M. = 1:3.

*Pl. 84:* Tonovcov grad, building 1. Coarse ware – bowls. 1–5 type 5; 6–13 type 6. Scale = 1:3.

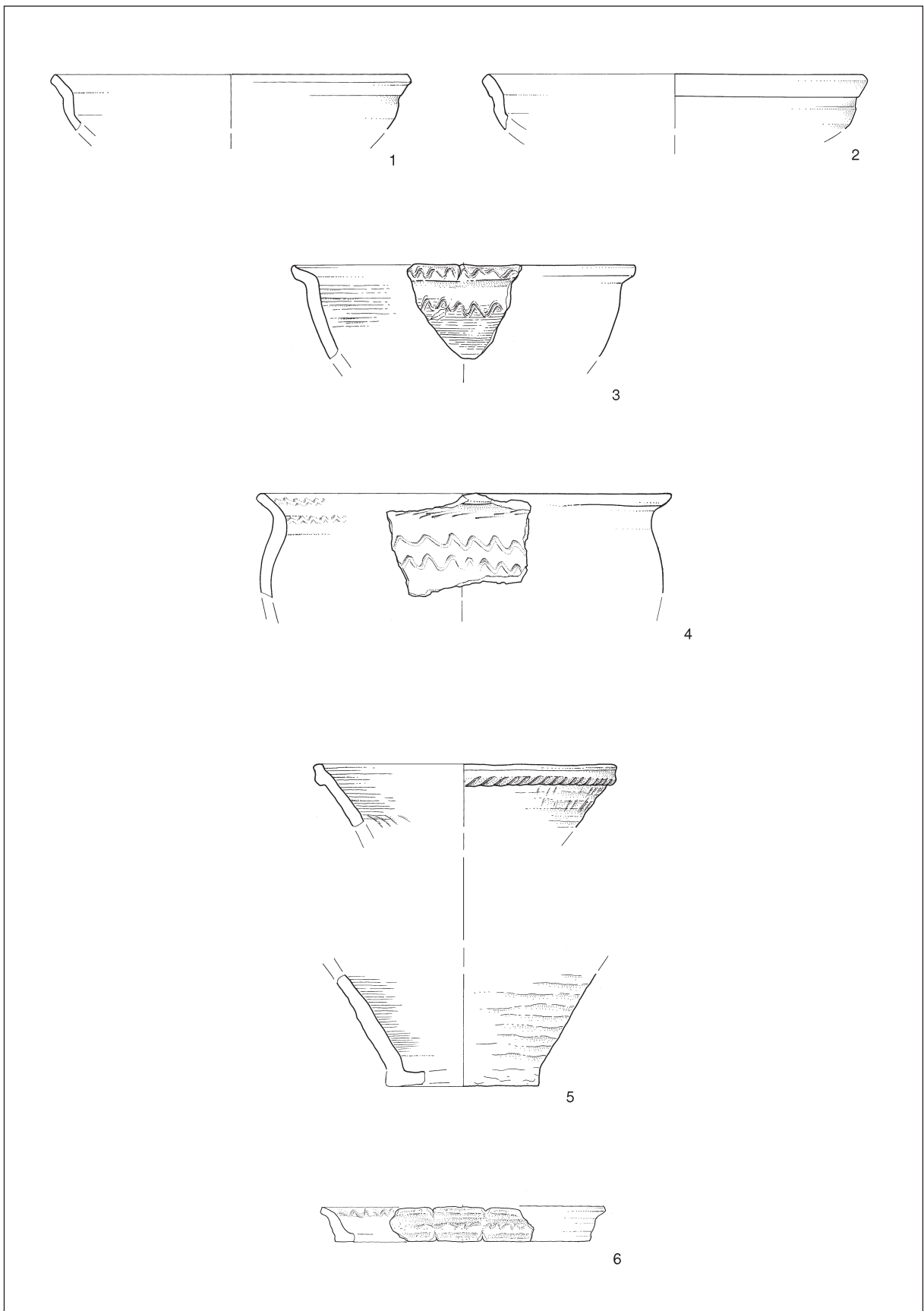

*T. 85:* Tonovcov grad, stavba 1. Groba keramika – sklede. 1–3 tip 7; 4 tip 8; 5 tip 9. 6 krožnik. M. = 1:3.  
*Pl. 85:* Tonovcov grad, building 1. Coarse ware – bowls. 1–3 type 7; 4 tipe 8; 5 type 9. 6 plate. Scale = 1:3.

TABLE / PLATES

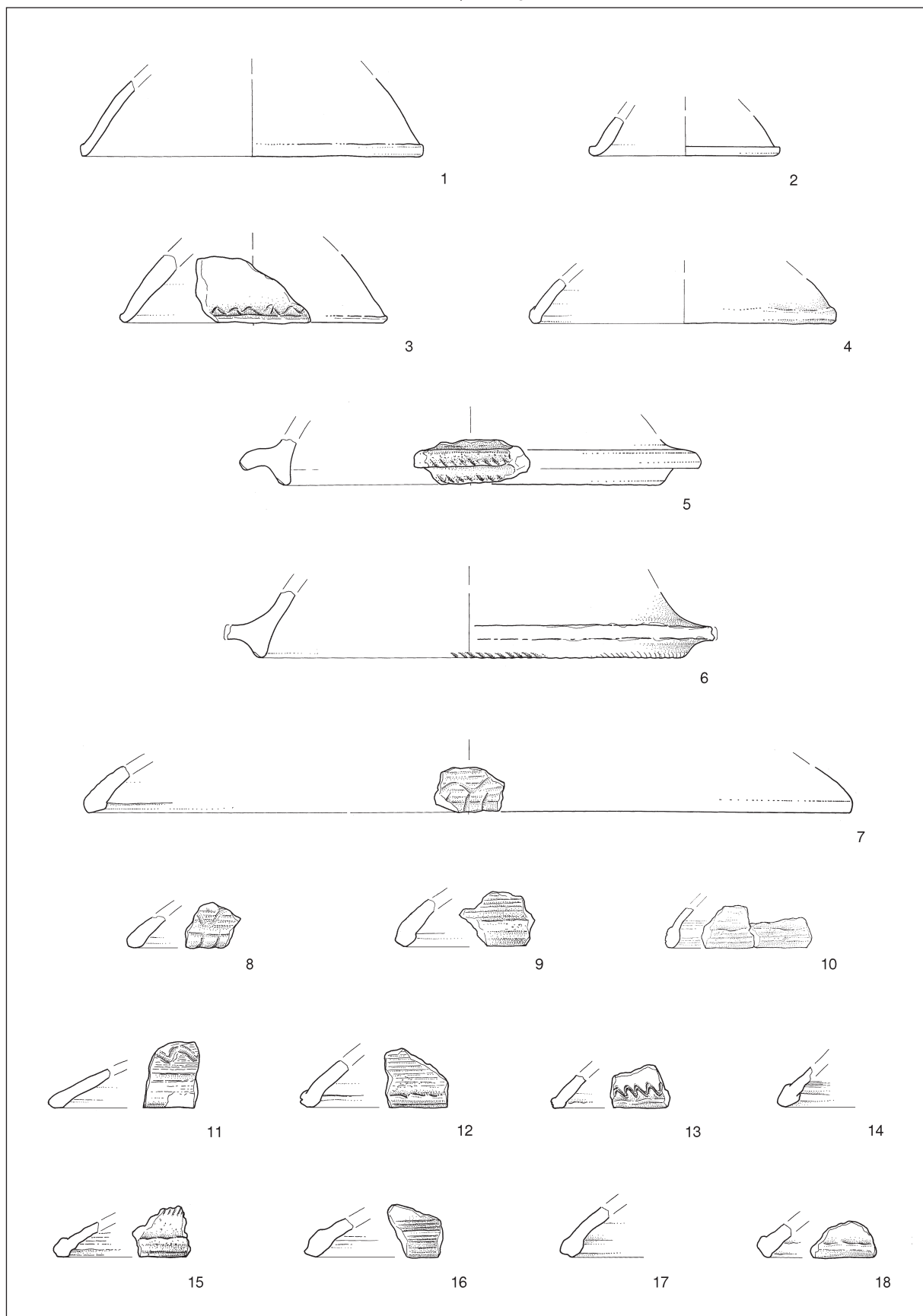

T. 86: Tonovcov grad, stavba 1. Groba keramika – pokrovi. M. = 1:3.

Pl. 86: Tonovcov grad, building 1. Coarse ware – lids. Scale = 1:3.



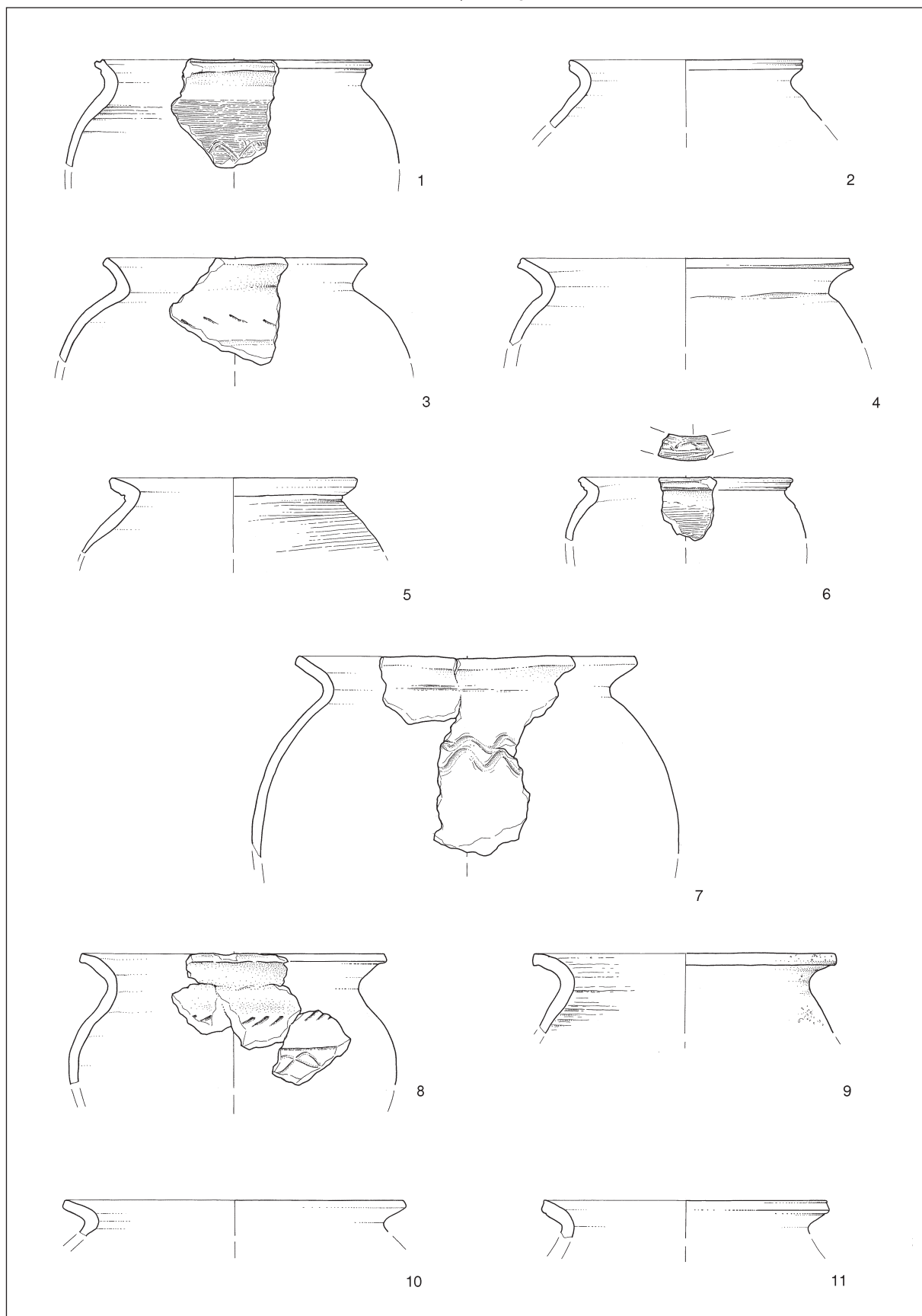

*T. 87:* Tonovcov grad, stavba 1. Groba keramika – lonci, tip 1. M. = 1:3.

*Pl. 87:* Tonovcov grad, building 1. Coarse ware – pots, type 1. Scale = 1:3.

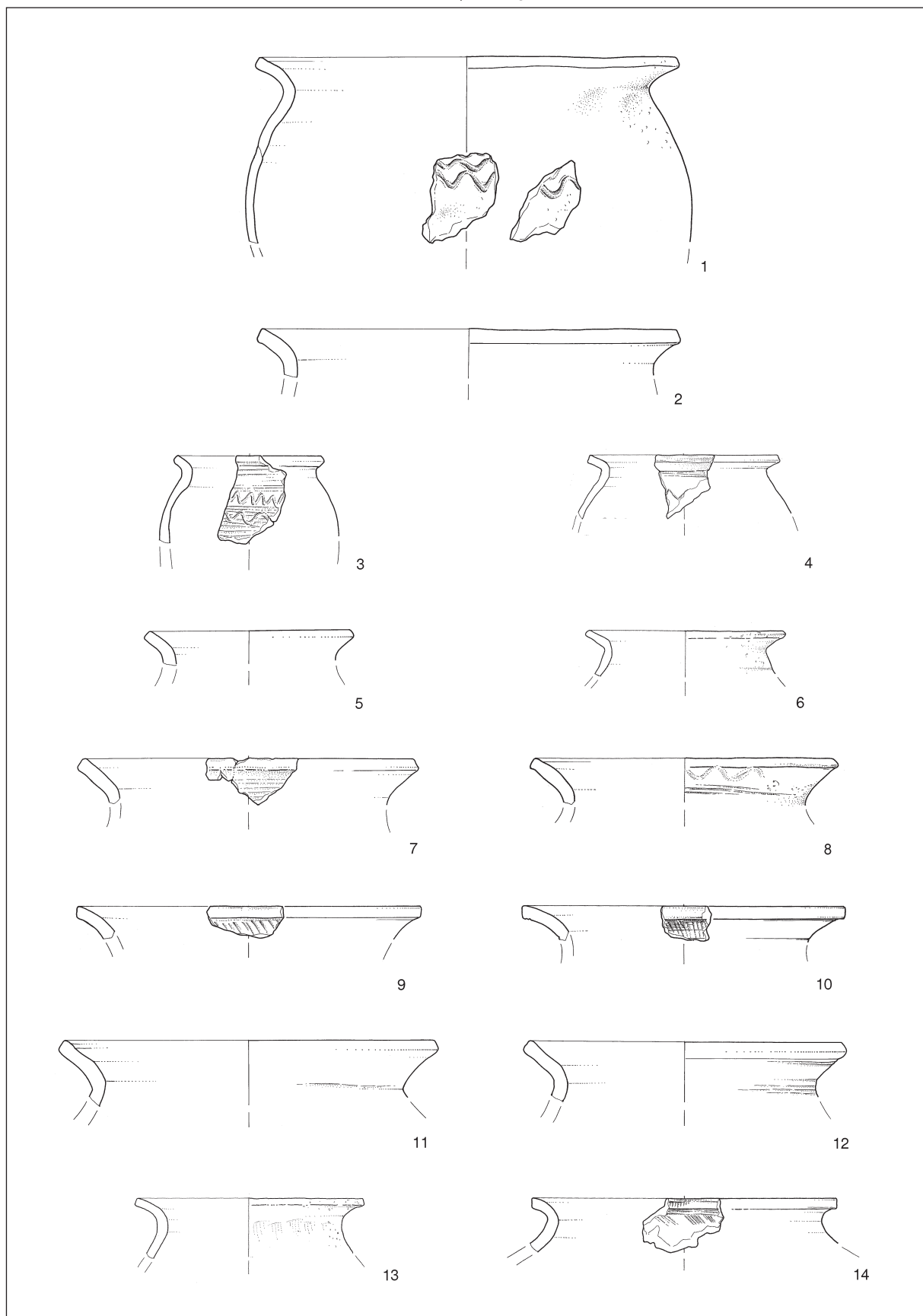

T. 88: Tonovcov grad, stavba 1. Groba keramika – lonci, tip 1. M. = 1:3.

Pl. 88: Tonovcov grad, building 1. Coarse ware – pots, type 1. Scale = 1:3.

TABLE / PLATES

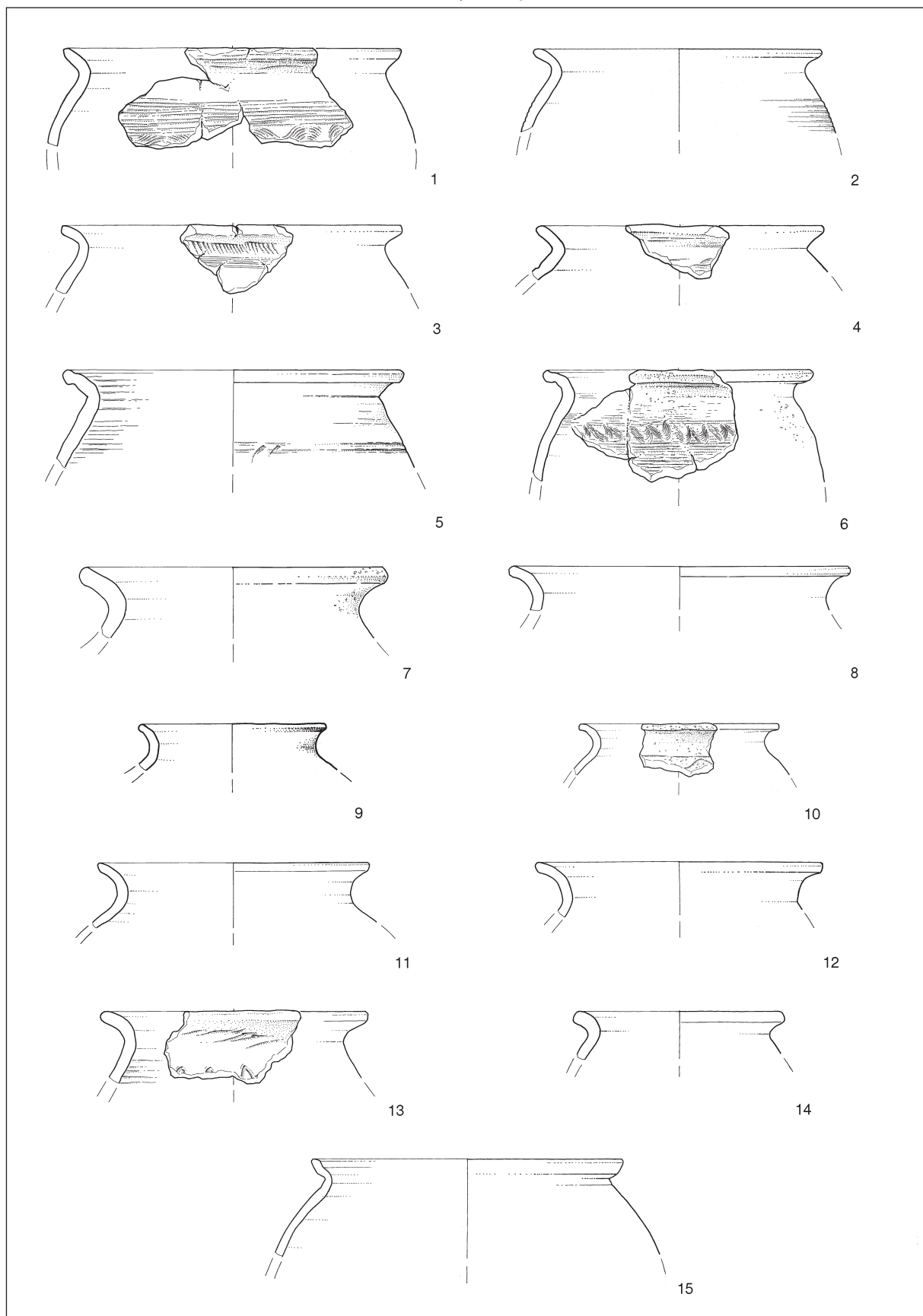

*T. 89:* Tonovcov grad, stavba 1. Groba keramika – lonci. 1–14 tip 1; 15 tip 2. M. = 1:3.

*Pl. 89:* Tonovcov grad, building 1. Coarse ware – pots. 1–14 type 1; 15 type 2. Scale = 1:3.

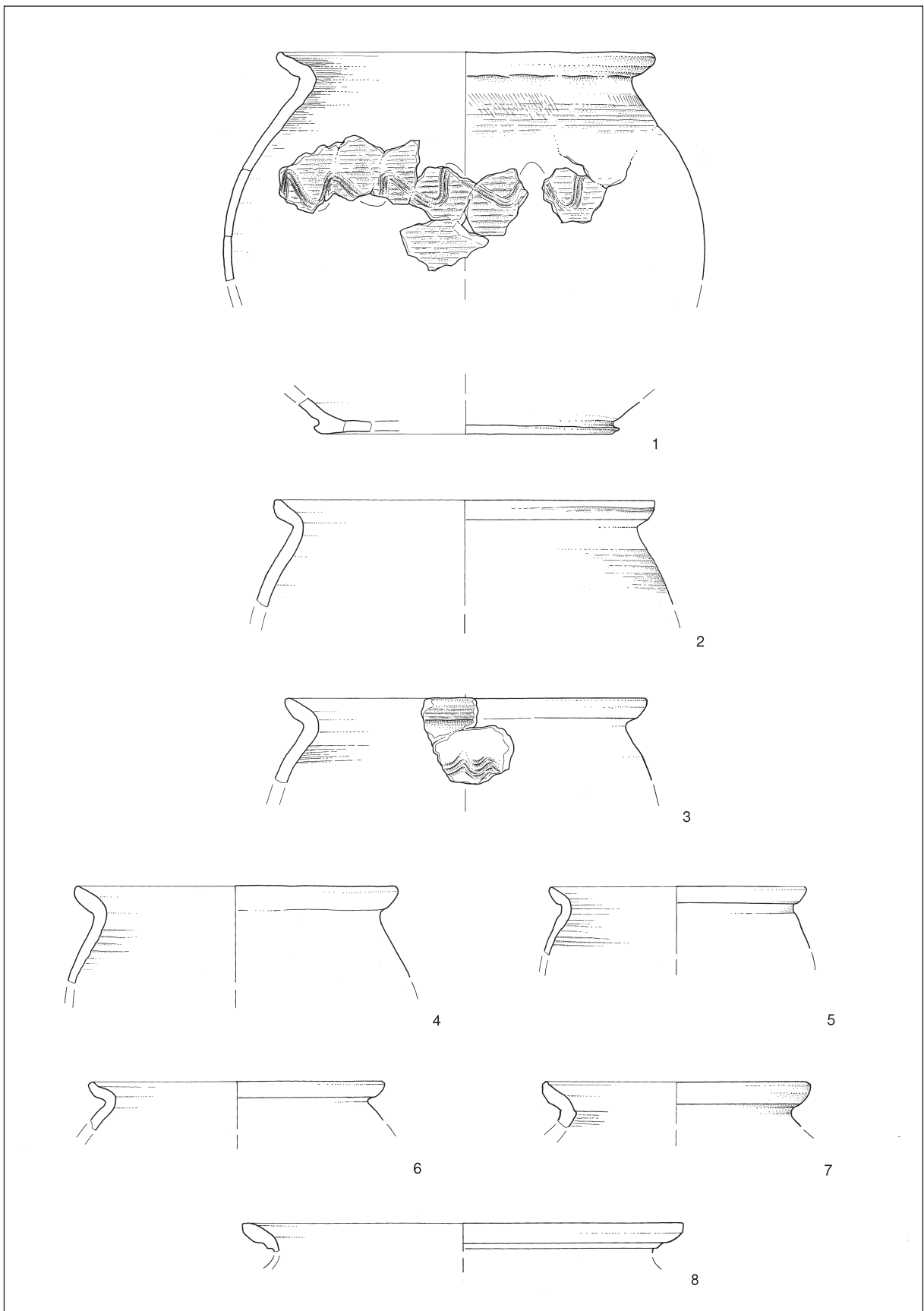

*T. 90:* Tonovcov grad, stavba 1. Groba keramika – lonci. 1–7 tip 2; 8 tip 3. M. = 1:3.

*Pl. 90:* Tonovcov grad, building 1. Coarse ware – pots. 1-7 type 2; 8 type 3. Scale = 1:3.

TABLE / PLATES

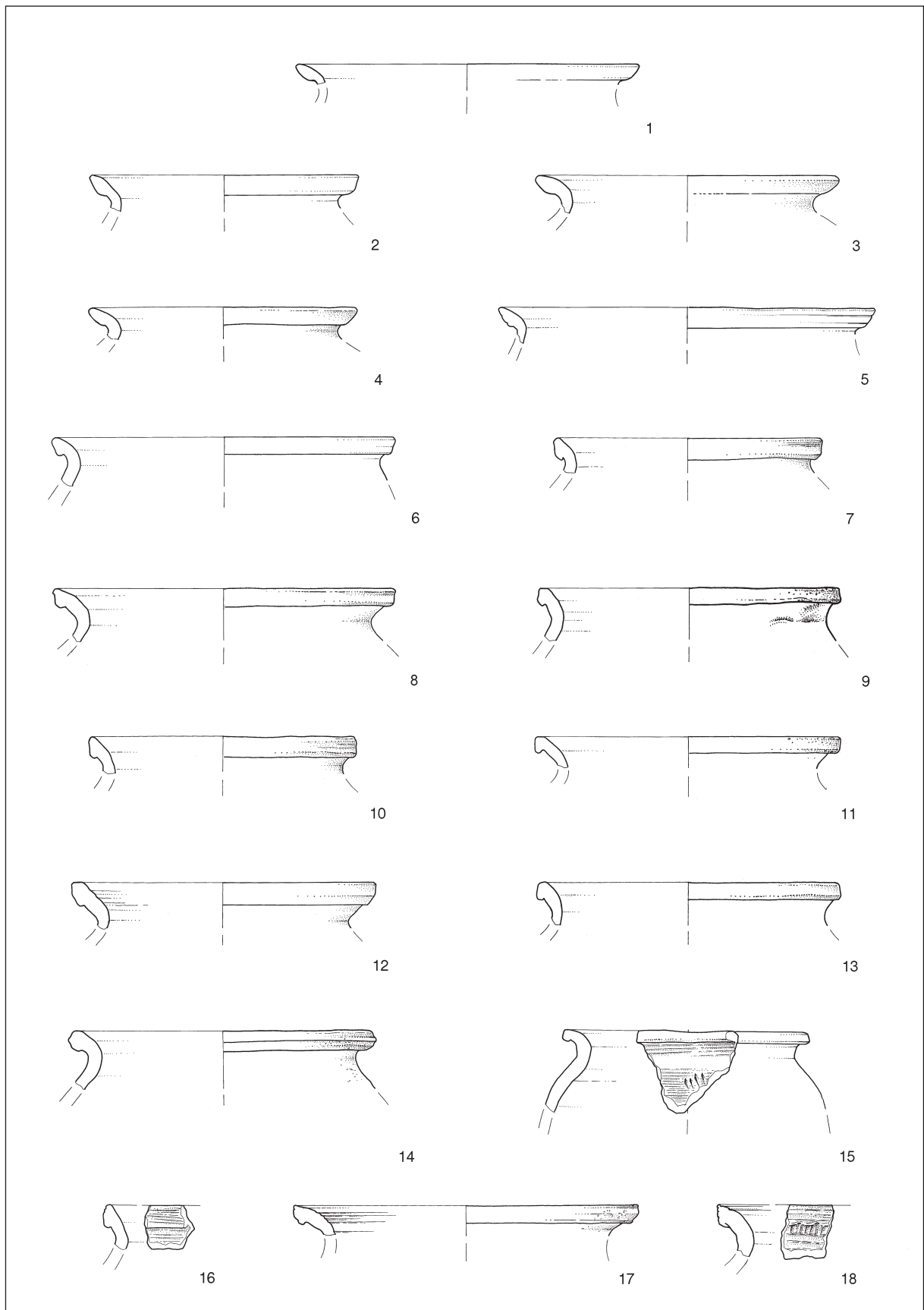

*T. 91:* Tonovcov grad, stavba 1. Groba keramika – lonci. 1–5 tip 3; 6–18 tip 4. M. = 1:3.

*Pl. 91:* Tonovcov grad, building 1. Coarse ware – pots. 1-5 type 3; 6-18 type 4. Scale = 1:3.

TABLE / PLATES

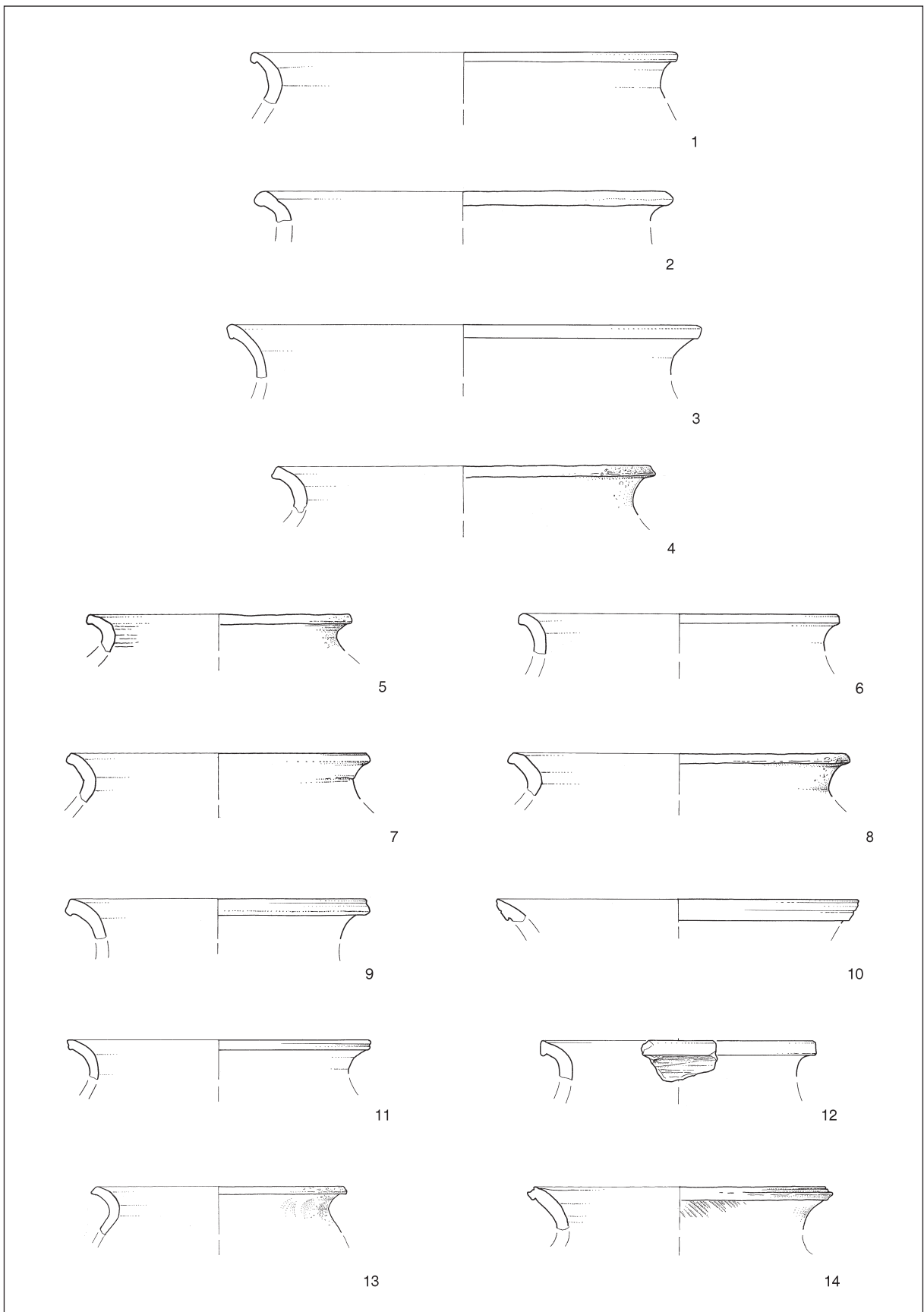

T. 92: Tonovcov grad, stavba 1. Groba keramika – lonci, tip 4. M. = 1:3.

Pl. 92: Tonovcov grad, building 1. Coarse ware – pots, type 4. Scale = 1:3.

TABLE / PLATES

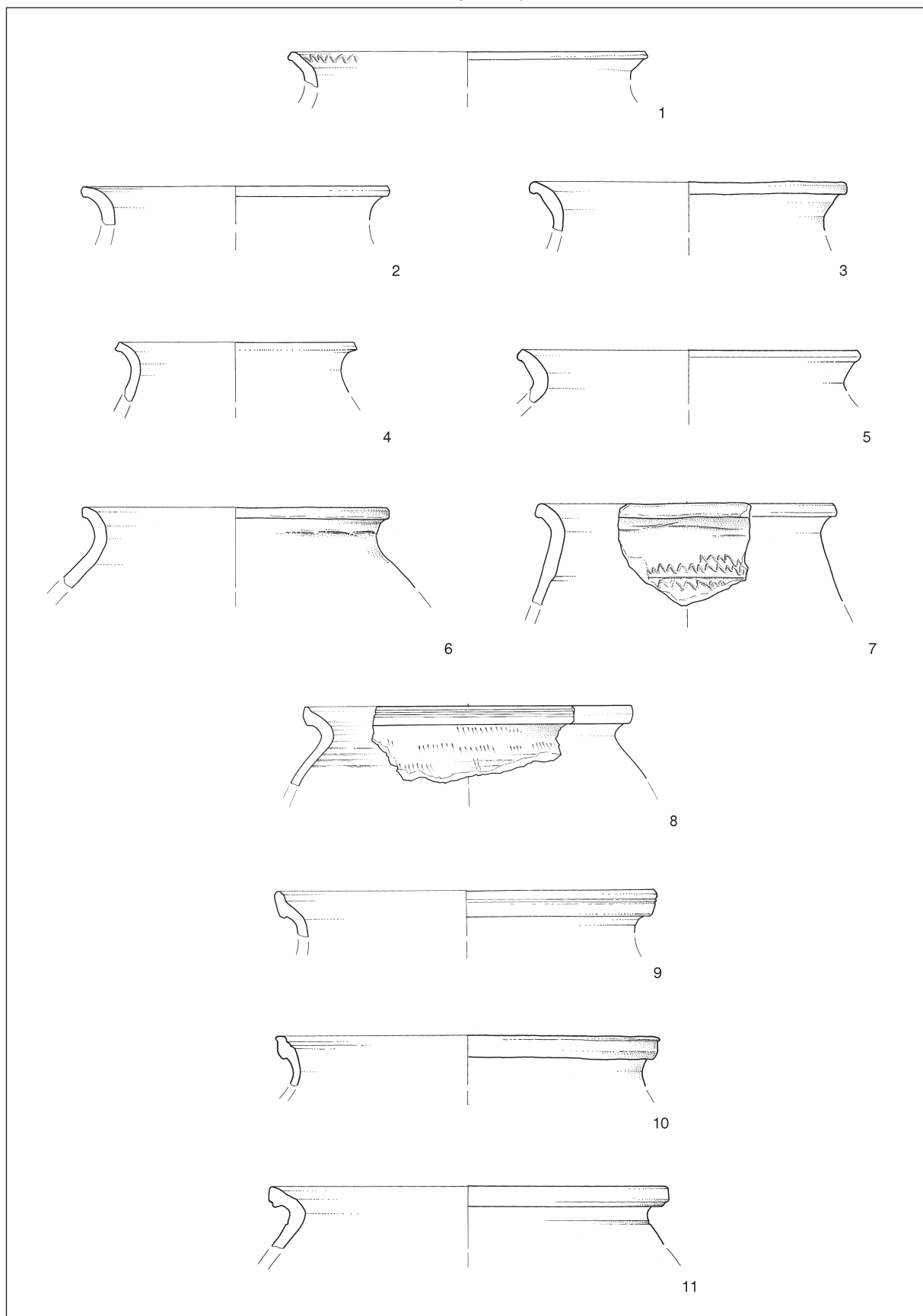

*T. 93:* Tonovcov grad, stavba 1. Groba keramika – lonci. 1–7 tip 4; 8–11 tip 5. M. = 1:3.

*Pl. 93:* Tonovcov grad, building 1. Coarse ware – pots. 1-7 type 4; 8-11 type 5. Scale = 1:3.

TABLE / PLATES

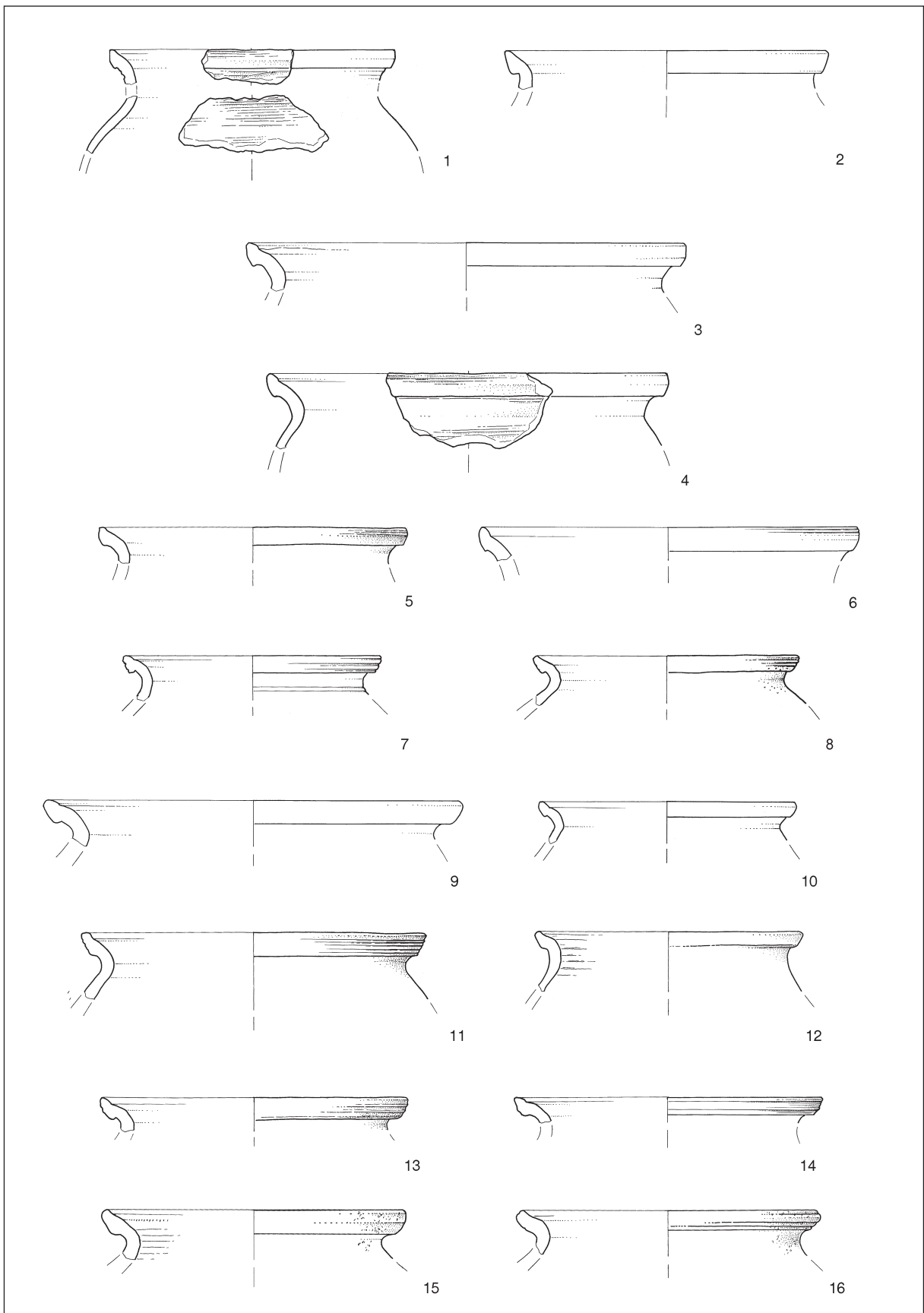

T. 94: Tonovcov grad, stavba 1. Groba keramika - lonci, tip 5. M. = 1:3.

Pl. 94: Tonovcov grad, building 1. Coarse ware - pots, type 5. Scale = 1:3.



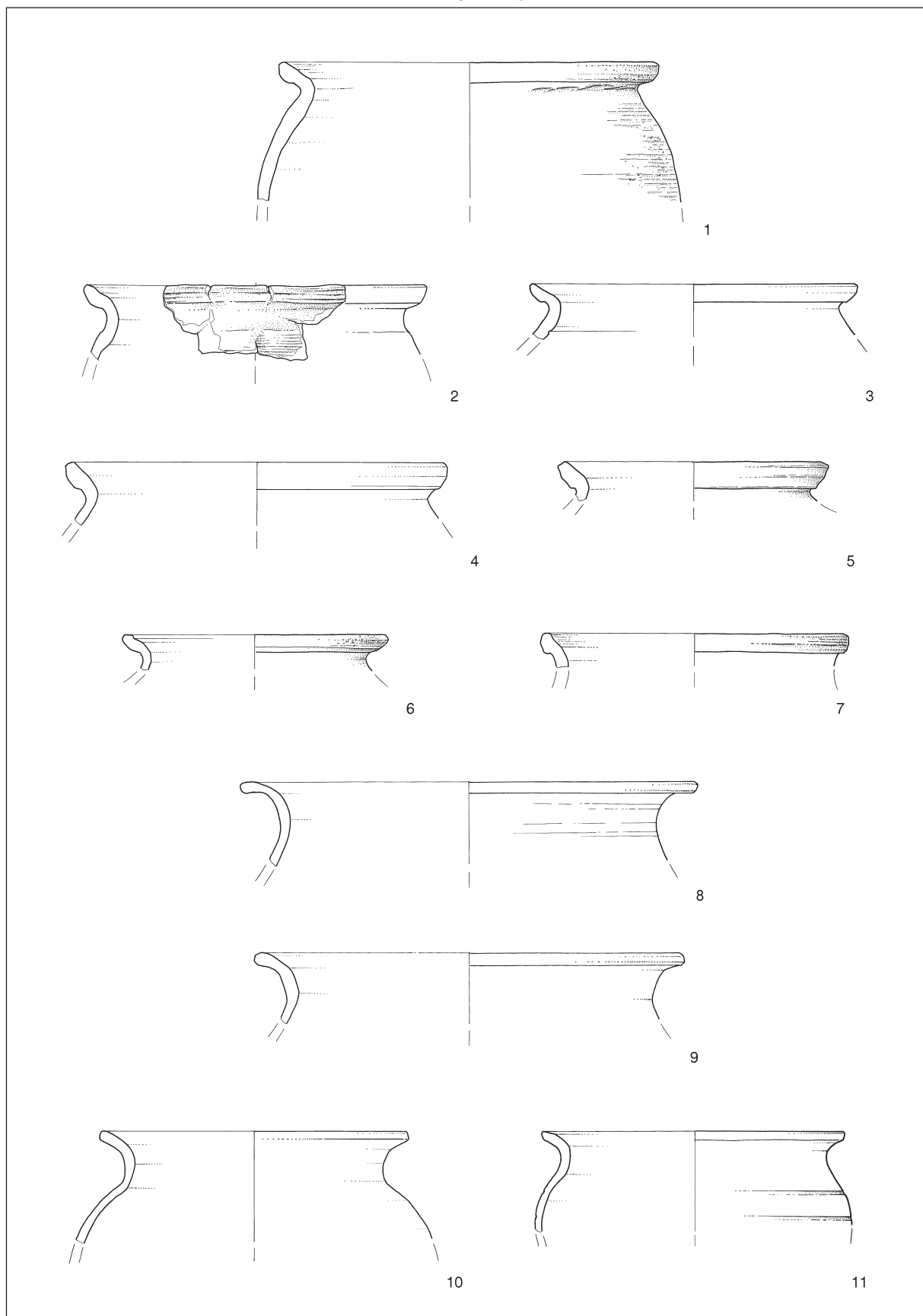

*T. 95:* Tonovcov grad, stavba 1. Groba keramika – lonci. 1–7 tip 5; 8–11 tip 6. M. = 1:3.

*Pl. 95:* Tonovcov grad, building 1. Coarse ware – pots. 1-7 type 5; 8-11 type 6. Scale = 1:3.

TABLE / PLATES

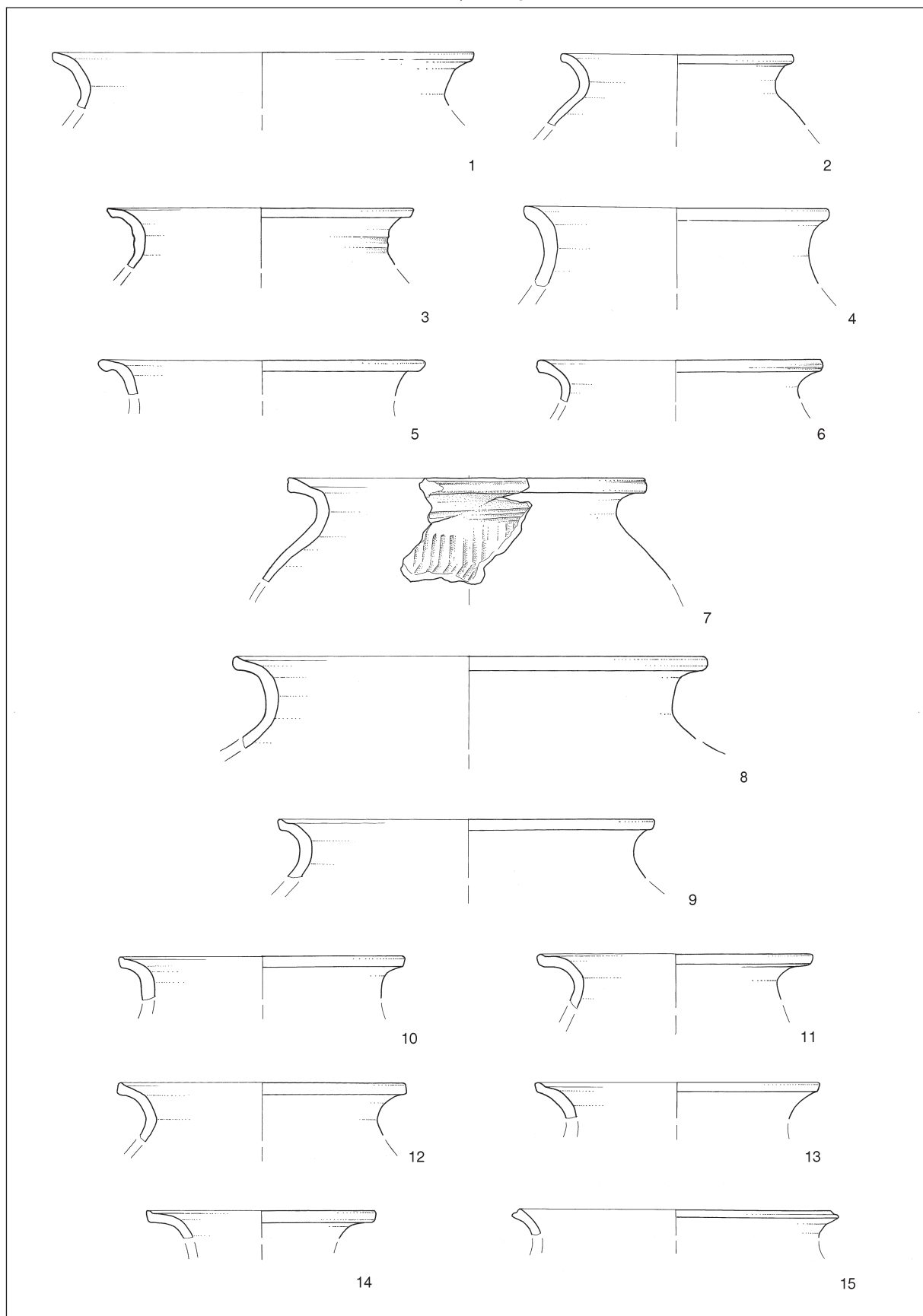

T. 96: Tonovcov grad, stavba 1. Groba keramika – lonci, tip 6. M. = 1:3.

Pl. 96: Tonovcov grad, building 1. Coarse ware – pots, type 6. Scale = 1:3.

TABLE / PLATES

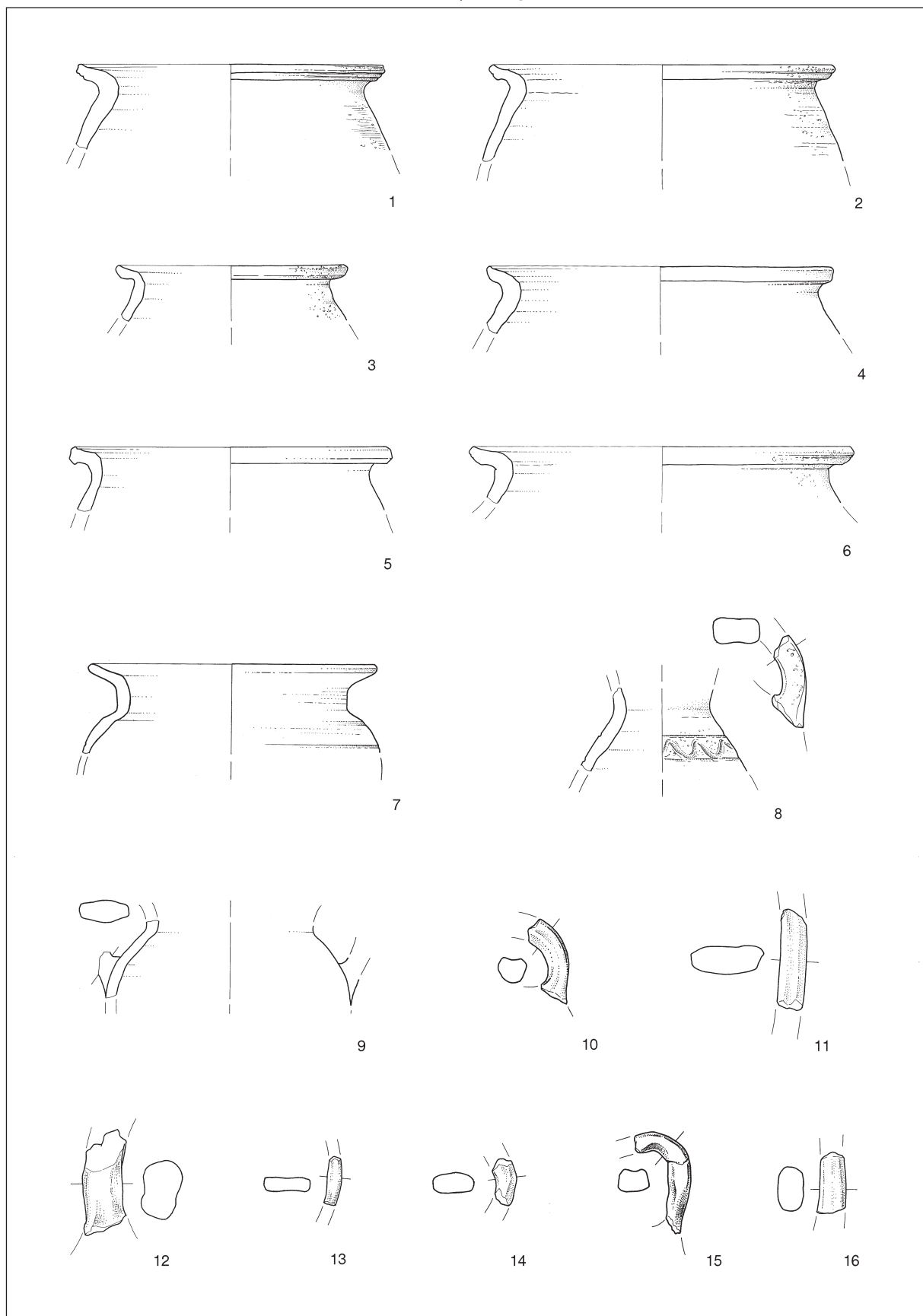

T. 97: Tonovcov grad, stavba 1. Groba keramika – lonci. 1–6 tip 7; 7 tip 8. 8–16 vrči. M. = 1:3.

Pl. 97: Tonovcov grad, building 1. Coarse ware – pots. 1-6 type 7; 7 type 8. 8-16 jugs. Scale = 1:3.

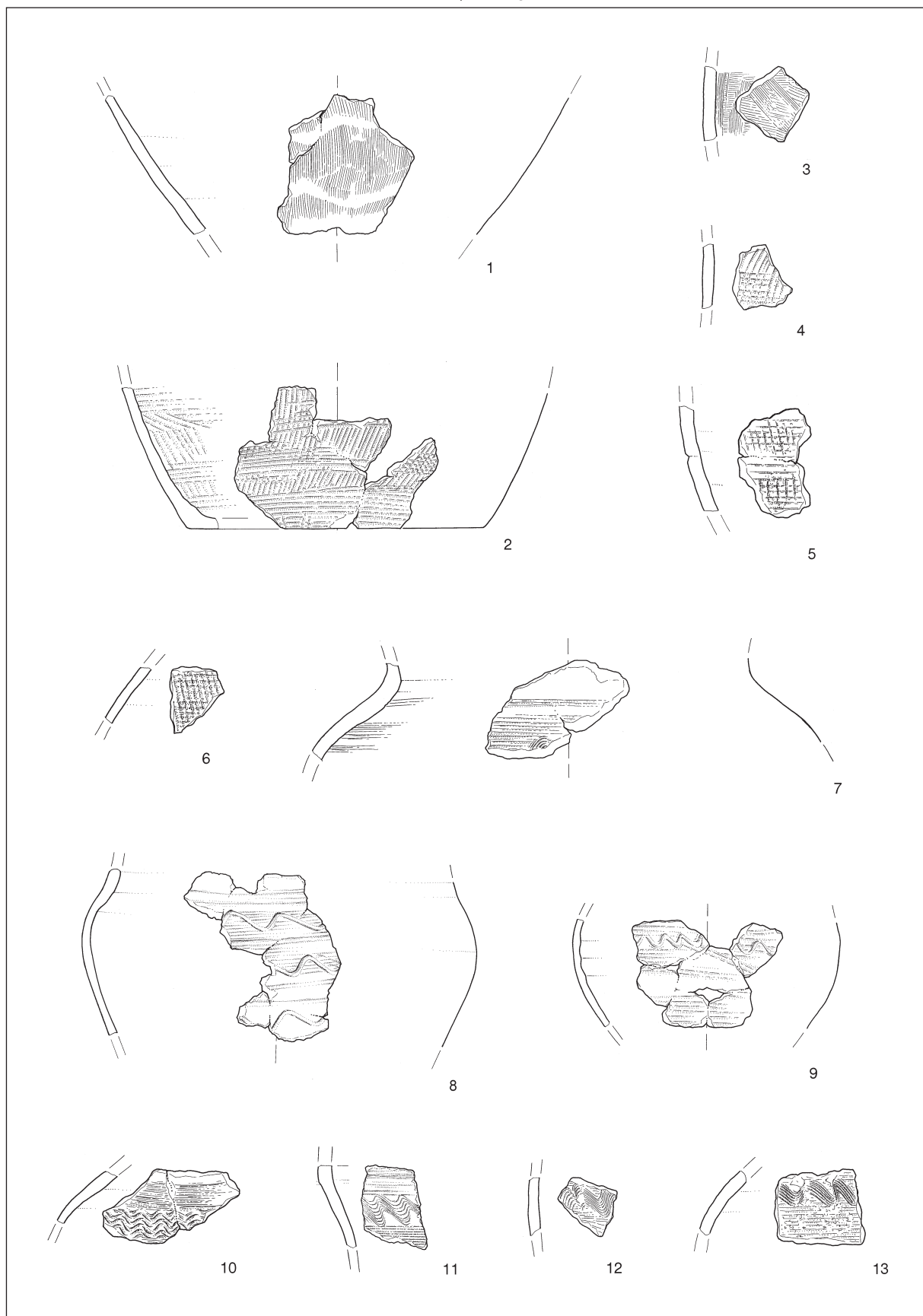

T. 98: Tonovcov grad, stavba 1. Groba keramika – okras. M. = 1:3.

Pl. 98: Tonovcov grad, building 1. Coarse ware – ornament. Scale = 1:3.

TABLE / PLATES

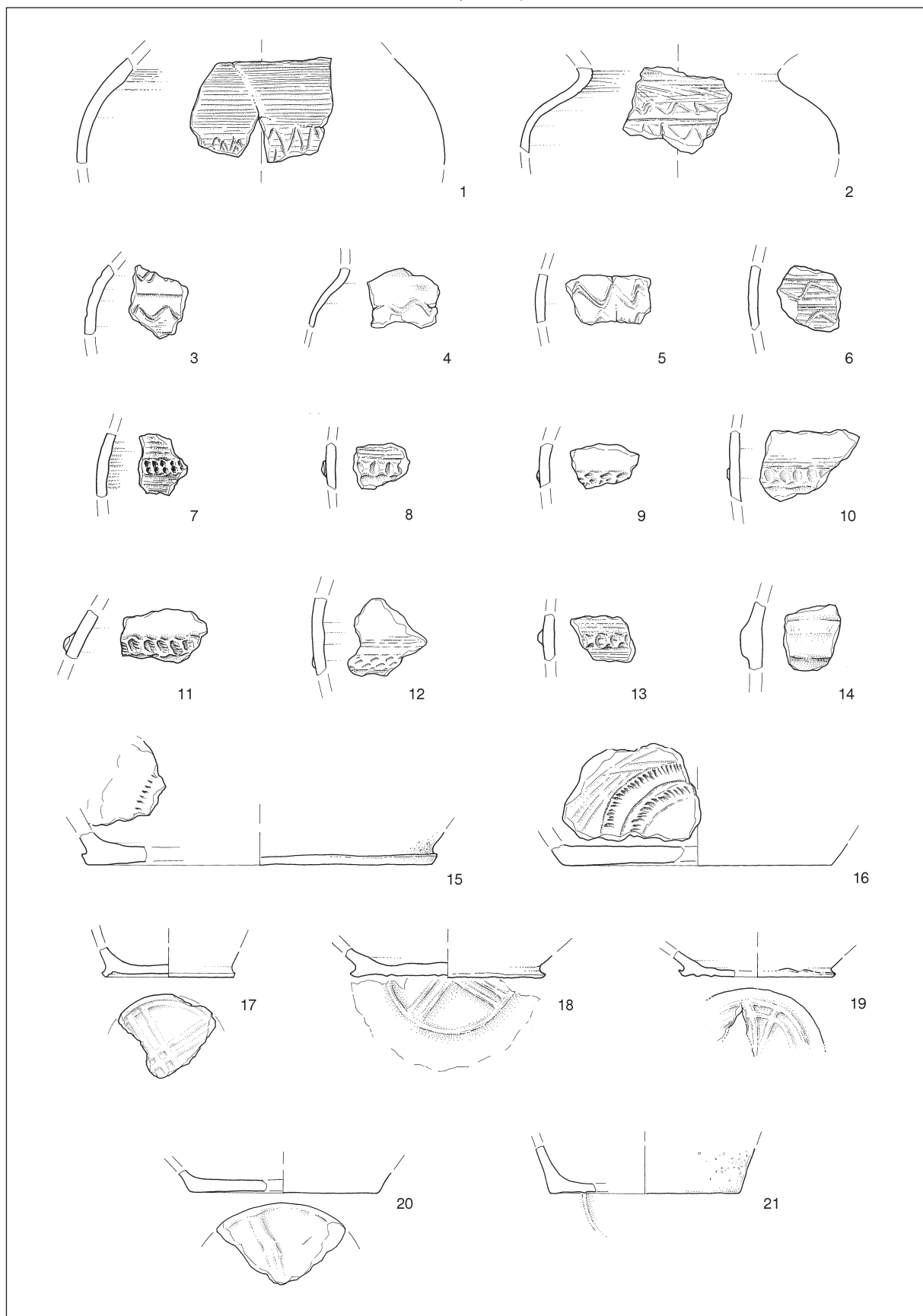

T. 99: Tonovcov grad, stavba 1. Groba keramika – okras. M. = 1:3.

Pl. 99: Tonovcov grad, building 1. Coarse ware – ornament. Scale = 1:3.

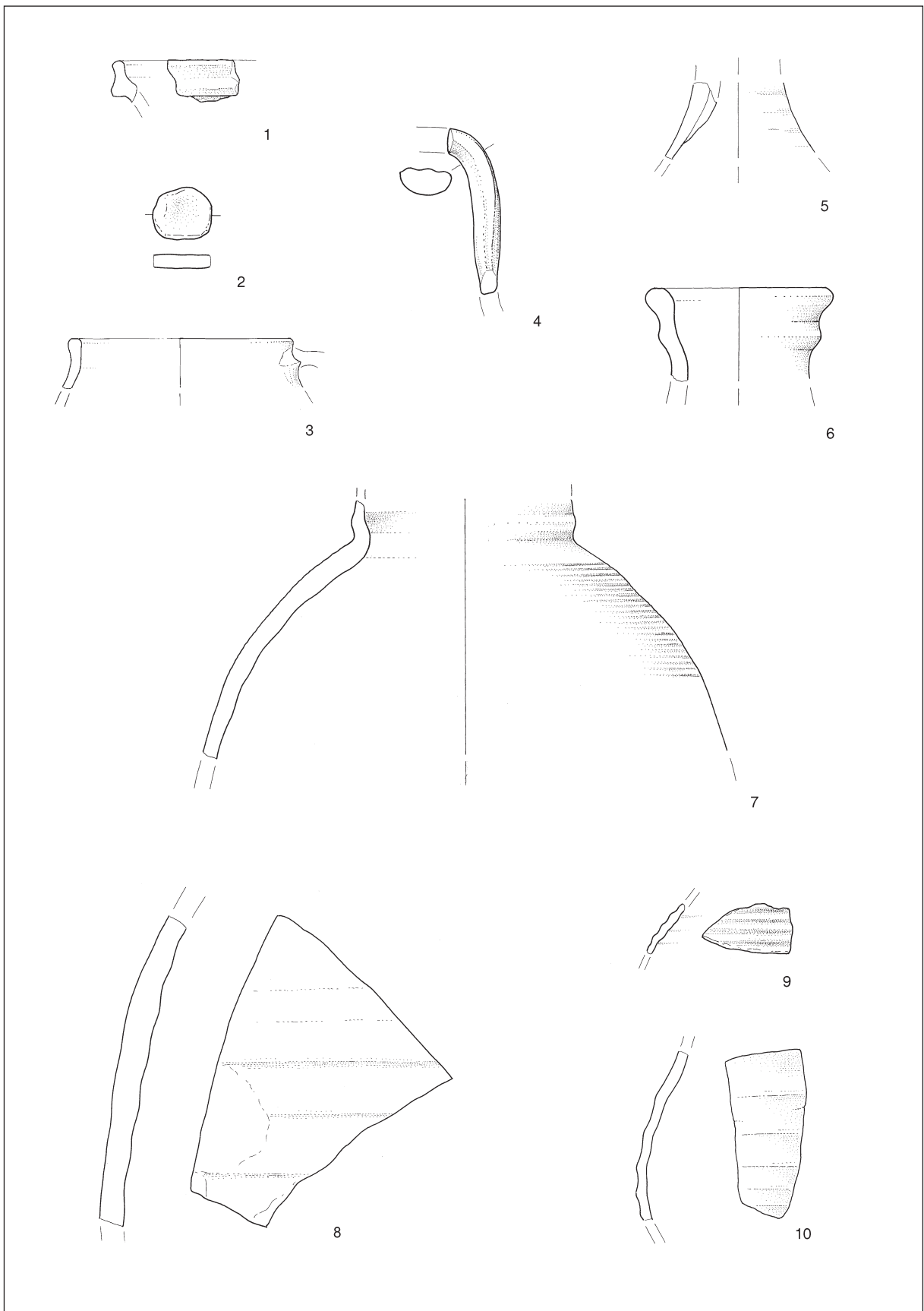

*T. 100:* Tonovcov grad, stavbi 2 in 3. Uvožena keramika. M. = 1:3.

*Pl. 100:* Tonovcov grad, buildings 2 and 3. Imported pottery. Scale = 1:3.

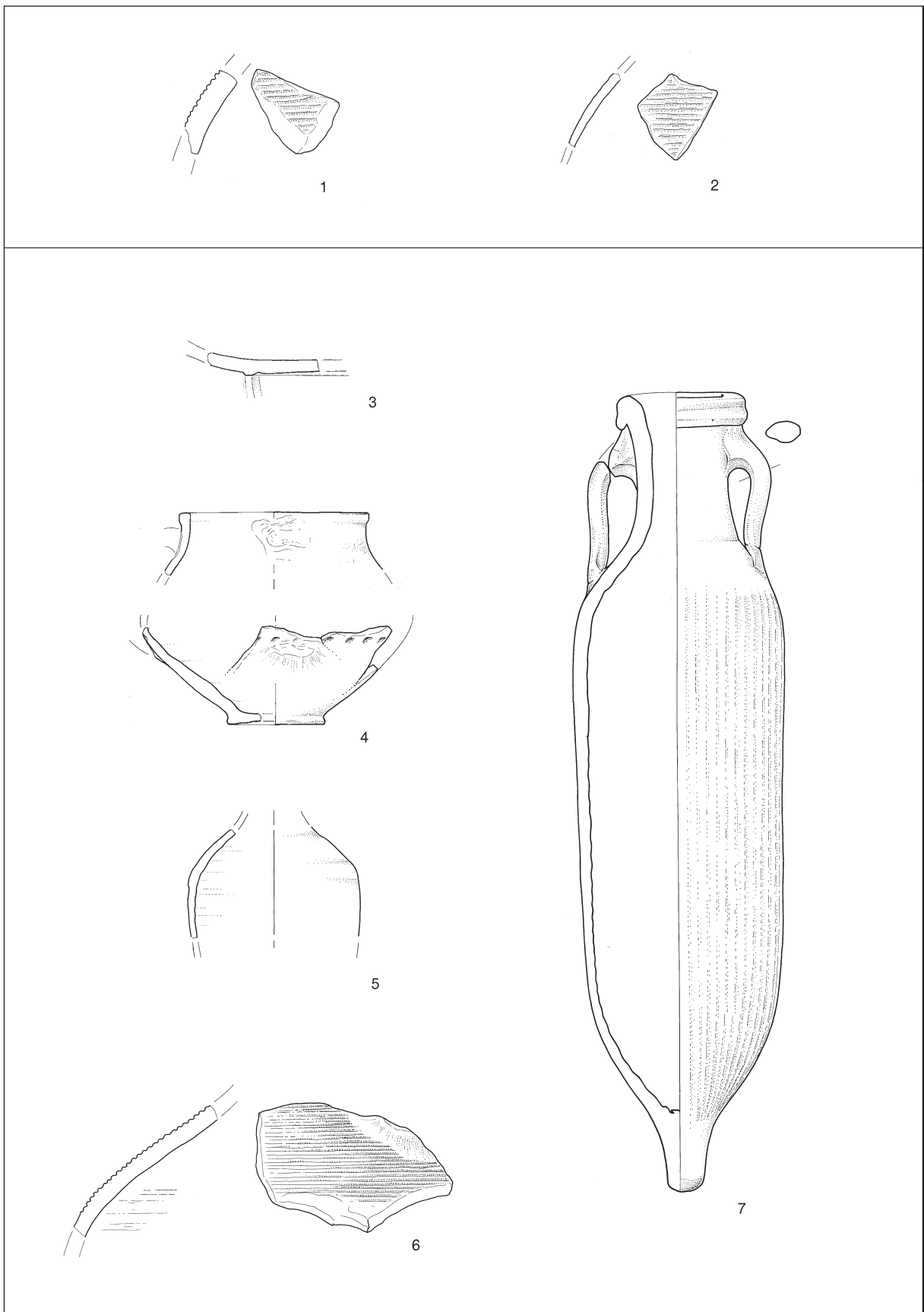

*T. 101:* Tonovcov grad. 1-2 stavbi 2 in 3; 3-7 sklop cerkva. Uvožena keramika. M. = 1:3.

*Pl. 101:* Tonovcov grad. 1-2 buildings 2 and 3; 3-7 ecclesiastical complex. Imported pottery. Scale = 1:3.

TABLE / PLATES

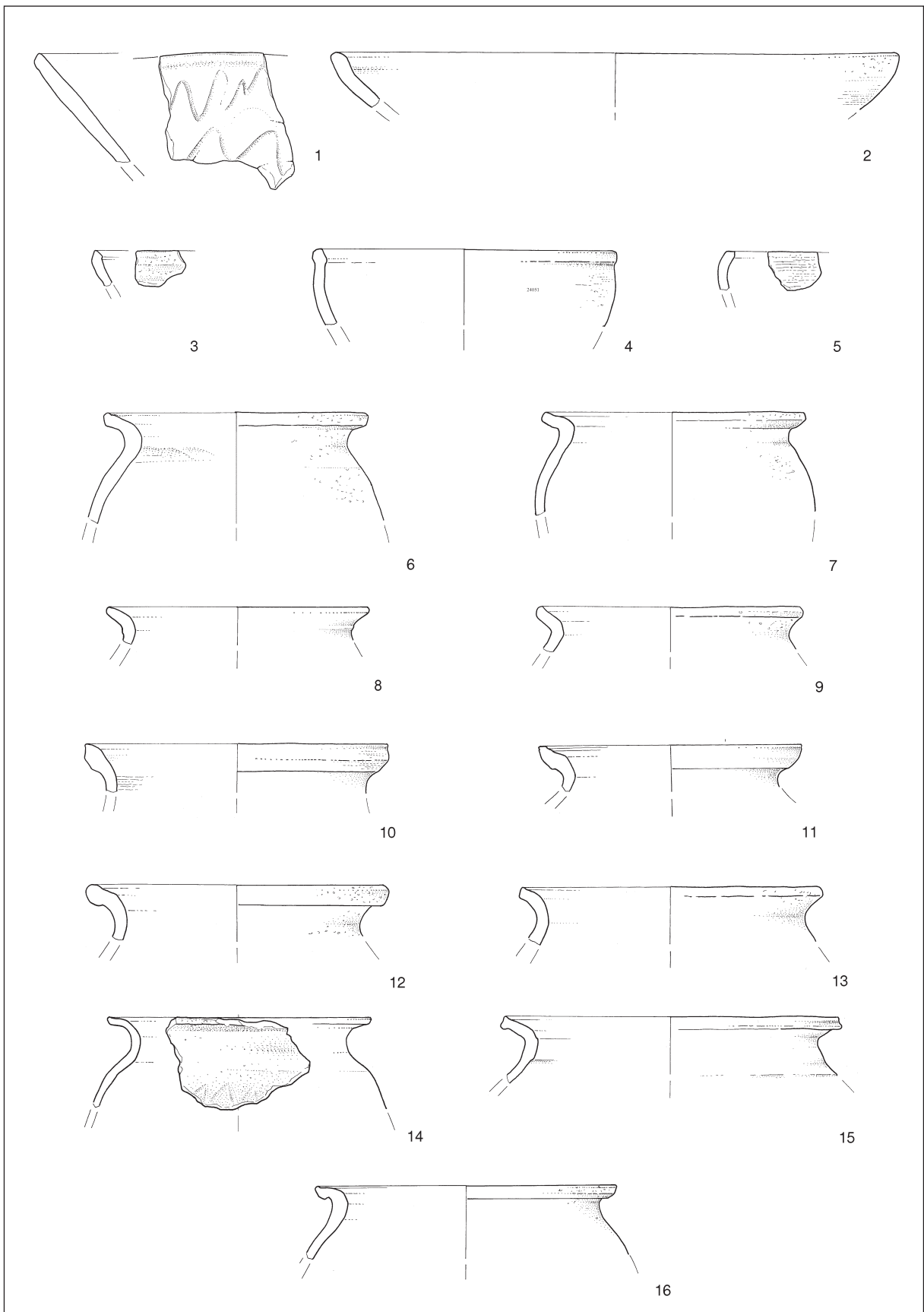

T. 102: Tonovcov grad, stavbi 2 in 3. Groba keramika. M. = 1:3.

Pl. 102: Tonovcov grad, buildings 2 and 3. Coarse ware. Scale = 1:3.



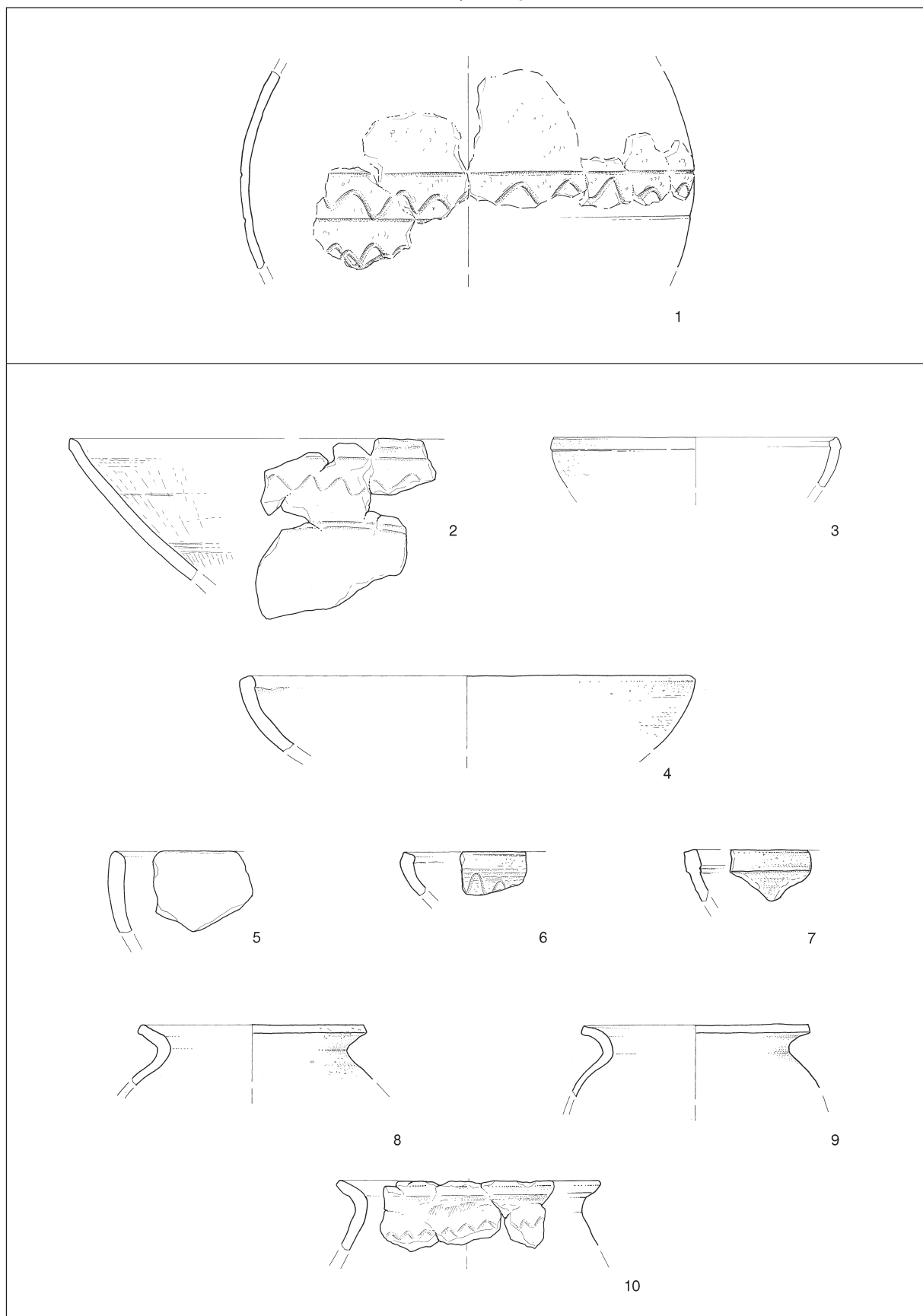

*T. 103:* Tonovcov grad. 1 stavba 3; 2–10 sklop cerkva. Groba keramika. M. = 1:3.

*Pl. 103:* Tonovcov grad. 1 building 3; 2-10 ecclesiastical complex. Coarse ware. Scale = 1:3.

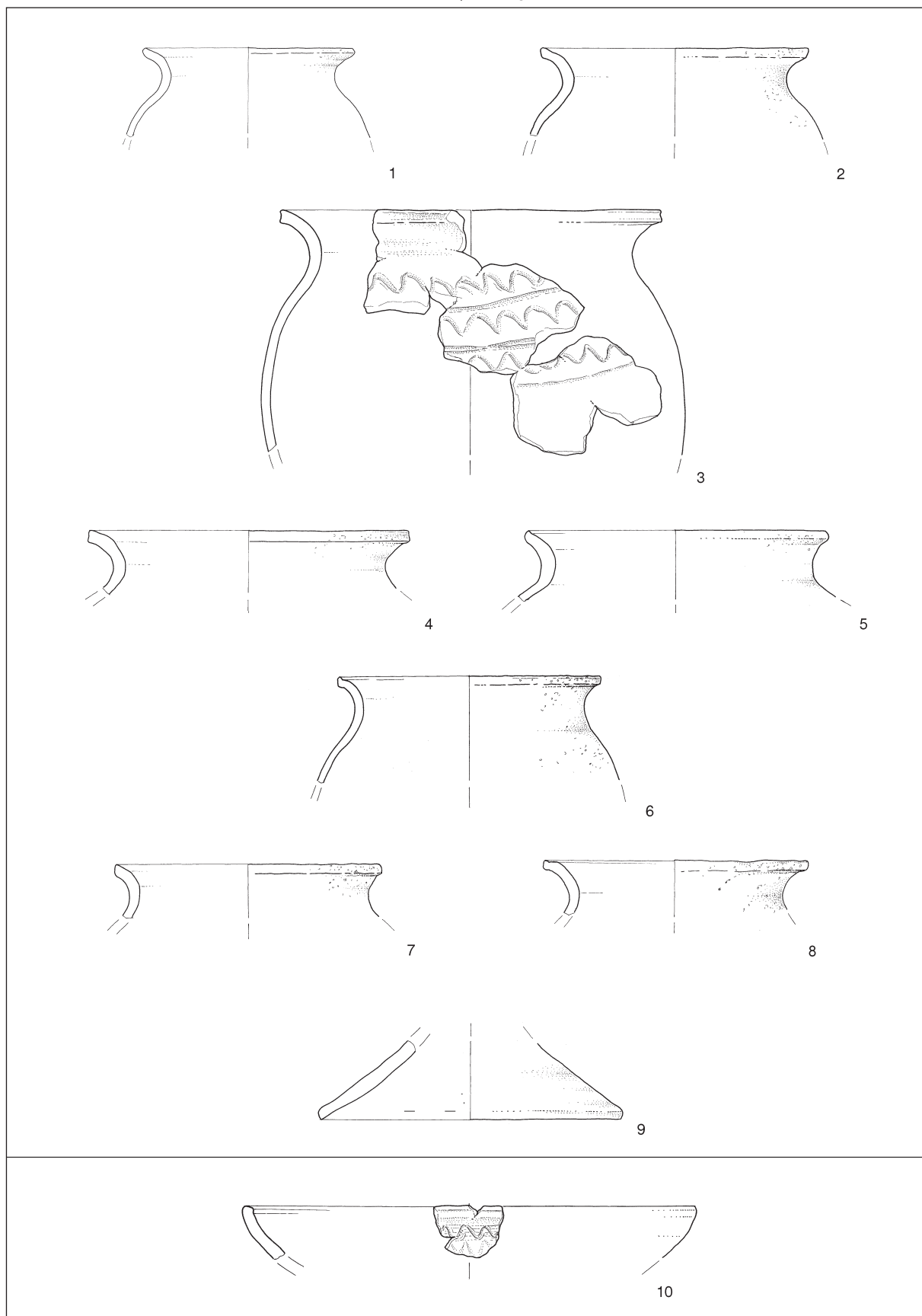

*T. 104:* Tonovcov grad. 1–9 sklop cerkva; 10 prostor med osrednjo in južno cerkvijo. Groba keramika. M. = 1:3.

*Pl. 104:* Tonovcov grad. 1–9 ecclesiastical complex; 10 the area between the main and south church. Coarse ware. Scale = 1:3.

TABLE / PLATES

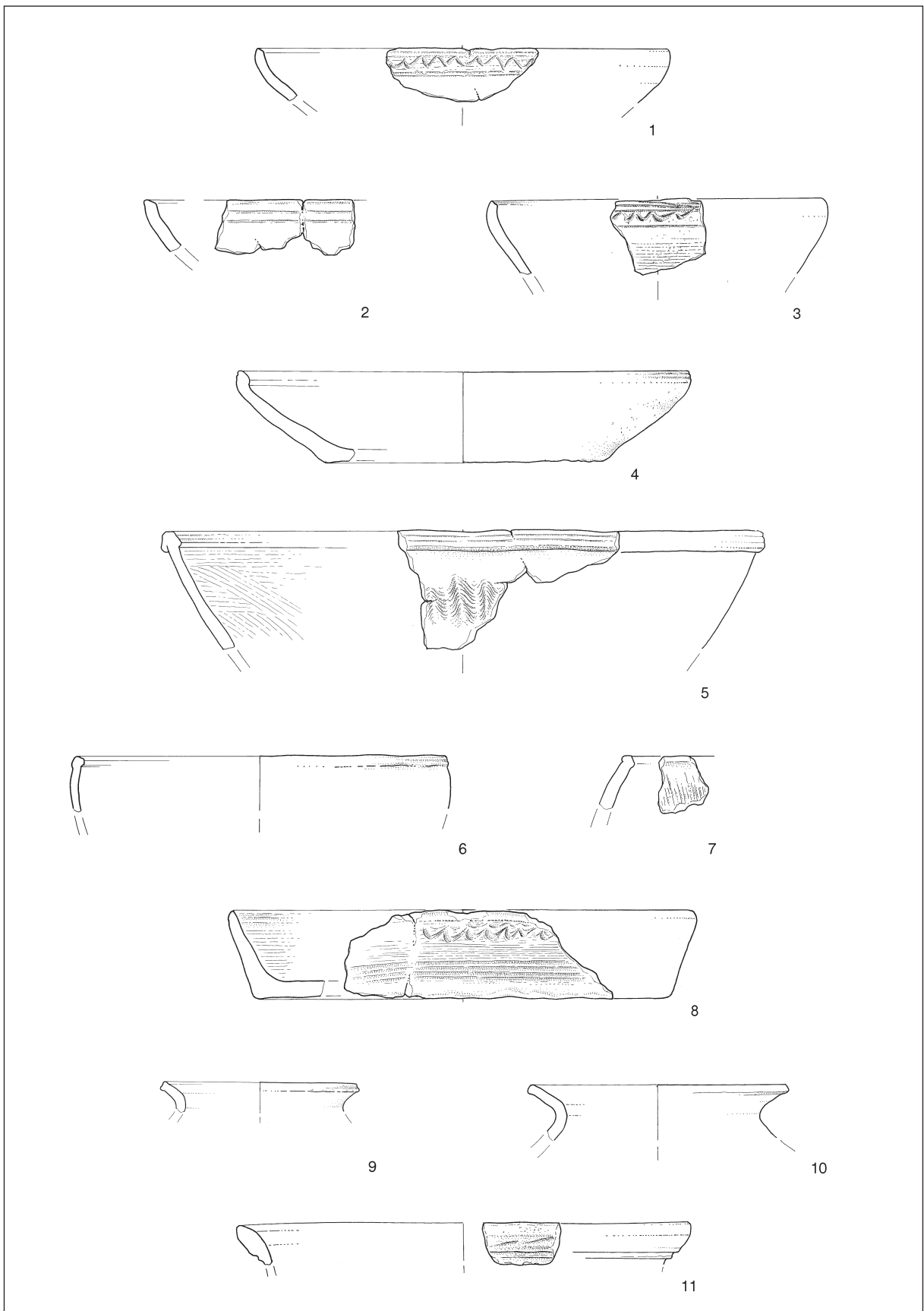

*T. 105:* Tonovcov grad, prostor med osrednjo in južno cerkvijo. Groba keramika. M. = 1:3.

*Pl. 105:* Tonovcov grad, the area between the main and south church. Coarse ware. Scale = 1:3.

TABLE / PLATES

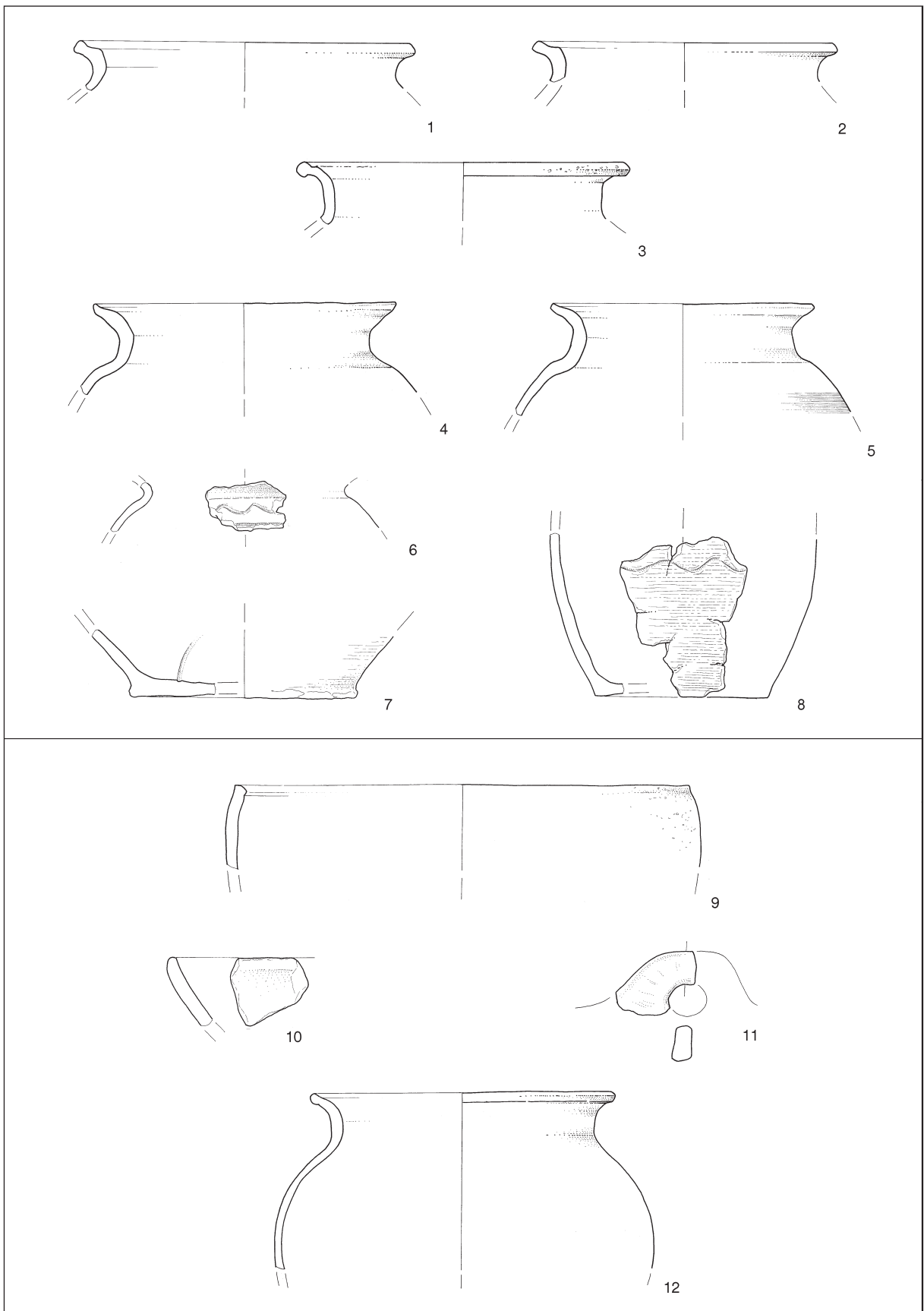

*T. 106*: Tonovcov grad. 1–8 prostor med osrednjo in južno cerkvijo; 9–12 cisterna. Groba keramika. M. = 1:3.

*Pl. 106*: Tonovcov grad. 1-8 the area between the main and south church; 9-12 cistern. Coarse ware. Scale = 1:3.

# SEZNAM AVTORJEV

## LIST OF CONTRIBUTORS

Francesco Boschin  
U.R. di Ecologia Preistorica  
Dipartimento di Scienze Ambientali "G. Sarfatti"  
Università degli Studi di Siena  
Via T. Pendola 62  
I-53100 Siena  
fboschin@hotmail.com

Dragan Božič  
Inštitut za arheologijo  
Znanstvenoraziskovalnega centra SAZU  
Novi trg 2  
SI-1000 Ljubljana  
dragan.bozic@zrc-sazu.si

Janez Dirjec  
Inštitut za arheologijo  
Znanstvenoraziskovalnega centra SAZU  
Novi trg 2  
SI-1000 Ljubljana  
iza@zrc-sazu.si

K. Patrick Fazioli  
Department of Anthropology  
University at Buffalo  
380 MFAC, North Campus  
Amherst, NY 14261 (USA)

Peter Kos  
Narodni muzej Slovenije  
Prešernova 20  
1000 Ljubljana  
peter.kos@nms.si

Petra Leben Seljak  
Dobračevska ulica 44  
SI-4226 Žiri  
petra.leben@gmail.com

Tina Milavec  
Oddelek za arheologijo  
Filozofska fakulteta, Univerza v Ljubljani  
Zavetiška 5  
SI-1000 Ljubljana  
tina.milavec@ff.uni-lj.si

Zvezdana Modrijan  
Inštitut za arheologijo  
Znanstvenoraziskovalnega centra SAZU  
Novi trg 2  
SI-1000 Ljubljana  
zvezdana.modrijan@zrc-sazu.si

Borut Toškan  
Inštitut za arheologijo  
Znanstvenoraziskovalnega centra SAZU  
Novi trg 2  
SI-1000 Ljubljana  
borut.toskan@zrc-sazu.si

Matija Turk  
Lunačkova 4  
SI-1000 Ljubljana  
matijaturkow@gmail.com

## Opera Instituti Archaeologici Sloveniae

1. Janez Dular, Slavko Ciglencečki, Anja Dular, Kučar. Železnodobno naselje in zgodnjekrščanski stavbni kompleks na Kučarju pri Podzemlju / Eisenzeitliche Siedlung und frühchristlicher Gebäudekomplex auf dem Kučar bei Podzemelj, 1995. (EUR 14.60)
2. Ivan Turk (ed.), Moustérienska »koščena piščal« in druge najdbe iz Divjih bab I v Sloveniji / Mousterian »bone flute« and other finds from Divje Babe I cave site in Slovenia, 1996. (EUR 14.60)
3. Jana Horvat (with contributions by Vesna Svetličič, Meta Bole, Metka Culiberg, Draško Josipović, Marko Stokin, Nina Zupančič), Sermin. Prazgodovinska in zgodnjersimska naselbina v severozahodni Istri / A Prehistoric and Early Roman Settlement in Northwestern Istria, 1997. (EUR 14.60)
4. Slavko Ciglencečki (with contributions by Zvezdana Modrijan, Andreja Dolenc Vičič, Ivan Turk), Tinje nad Loko pri Žusmu. Poznoantična in zgodnjersrednjeveška naselbina / Tinje oberhalb von Loka pri Žusmu. Spätantike und frühmittelalterliche Siedlung, 2000. (EUR 14.60)
5. Janez Dular, Irena Šavel, Sneža Tecco Hvala, Bronastodobno naselje Oloris pri Dolnjem Lakošu / Bronzezeitliche Siedlung Oloris bei Dolnji Lakoš, 2002. (EUR 14.60)
6. Janez Dular, Halštatske nekropole Dolenjske / Die hallstattzeitlichen Nekropolen in Dolenjsko, 2003. (EUR 20.70)
7. Irena Lazar, Rimsko steklo Slovenije / The Roman glass of Slovenia, 2003. (EUR 27.40)
8. Anton Velušček (ed.), Hočevarica. Eneolitsko kolišče na Ljubljanskem barju / An eneolithic pile dwelling in the Ljubljansko barje, 2004. (EUR 52.40)
9. Ivan Turk (ed.), Viktorjev spodmol in / and Mala Triglavca. Prispevki k poznavanju mezolitskega obdobja v Sloveniji / Contributions to understanding the Mesolithic period in Slovenia, 2004. (EUR 42.40)
10. Anton Velušček (ed.), Resnikov prekop. Najstarejša koliščarska naselbina na ljubljanskem barju / The oldest pile-dwelling settlement in the Ljubljansko barje, 2005. (EUR 40.00)
11. Andrej Gaspari (ed.), Zalog pri Verdu. Tabor kamenodobnih lovcev na zahodnem robu Ljubljanskega barja / Zalog near Verd. Stone Age hunters' camp at the western edge of the Ljubljansko barje, 2006. (EUR 43.00)
12. Janez Dular, Sneža Tecco Hvala, South-Eastern Slovenia in the Early Iron Age. Settlement - Economy - Society / Jugovzhodna Slovenija v starejši železni dobi. Poselitev - gospodarstvo - družba, 2007. (EUR 58.00)
13. Ivan Turk (ed.), Divje babe I. Paleolitsko najdišče mlajšega pleistocena v Sloveniji. I. del: Geologija in paleontologija / Divje babe I. Upper Pleistocene Palaeolithic site in Slovenia. Part I: Geology and Palaeontology, 2007. (EUR 82.00)
14. Andrej Pleterski (with Timotej Knific, Borut Toškan, Janez Dirjec, Benjamin Štular and Mateja Belak), Zgodnjersrednjeveška naselbina na blejski Pristavi. Najdbe / Frühmittelalterliche Siedlung Pristava in Bled. Funde, 2008. (EUR 51.00)
15. Benjamin Štular, Mali grad. Visokosrednjeveški grad v Kamniku / Mali grad. High Medieval Castle in Kamnik, 2008. (EUR 51.00)
16. Anton Velušček (ed.), Koliščarska naselbina Stare gmajne in njen čas. Ljubljansko barje v 2. polovici 4. tisočletja pr. Kr. / Stare gmajne pile-dwelling settlement and its era. The Ljubljansko barje in the 2nd half of the 4th millennium BC, 2009. (EUR 56.00)
17. Jana Horvat, Alma Bavdek, Okra. Vrata med Sredozemljem in Srednjo Evropo / Ocra. The gateway between the Mediterranean and Central Europe, 2009. (EUR 51.00)
18. Janez Dular, Marjana Tomanič Jevremov, Ormož. Utrjeno naselje iz pozne bronaste in starejše železne dobe / Ormož. Befestigte Siedlung aus der späten Bronze- und der älteren Eisenzeit, 2010. (EUR 57.00)

19. Andrej Pleterski (with contributions by Igorj Bahor, Vid Pleterski, Marko Žagar and Veronika Pflaum), Zgodnjesrednjevska naselbina na blejski Pristavi. Tafonomija, predmeti in čas. / Frühmittelalterliche Siedlung Pristava in Bled. Taphonomie, Fundgegenstände und zeitliche Einordnung, 2010. (EUR 39.00)

20. Jana Horvat and Andreja Dolenc Vičič (with the contribution of Marjana Tomanič Jevremov and Marija Lubšina Tušek), Arheološka najdišča Ptuja. Rabelčja vas / Archaeological Sites of Ptuj. Rabelčja vas, 2010. (EUR 45.00)

21. Borut Toškan (ed.), Drobci ledenodobnega okolja. Zbornik ob življenjskem jubileju Ivana Turka / Fragments of Ice Age environments. Proceedings in Honour of Ivan Turk's Jubilee, 2011. (EUR 45.00)

22. Anton Velušček (ed.), Spaha, 2011. (EUR 47.00)

23. Slavko Ciglencečki, Zvezdana Modrijan, Tina Milavec (with contributions of Benjamin Štular, Saša Čaval and Ivan Šprajc), Poznoantična utrjena naselbina Tonovcov grad pri Kobaridu. Naselbinski ostanki in interpretacija / Late Antique fortified settlement Tonovcov grad near Kobarid. Settlement remains and interpretation, 2011. (EUR 55.00)

Borut Toškan (ed.)

### **Drobci ledenodobnega okolja**

Zbornik ob življenjskem jubileju Ivana Turka

### **Fragments of Ice Age environments**

Proceedings in Honour of Ivan Turk's Jubilee

The monograph presents a compilation of seventeen chapters in which experts from different scientific fields discuss specific topics related to the Ice Age in Europe. Ten of them are devoted to the presentation, analysis and interpretation of palaeontological data concerning various large mammal species ranging from mastodon and mammoth to the cave hyena, ibex, cave lion and bears, with the emphasis being placed on the cave bear. Several chapters address the topic of Last Glacial climatic conditions in the Southeastern Alps by studying fossil micromammal and palaeobotanical remains as well as geoarchaeological data. A special article is devoted to a comprehensive review of previous analysis of the bone flute from Divje babe I, but includes also new musicological research findings on the extraordinary technical capabilities of this oldest musical instrument. The concluding chapter presents a study of old manuscripts and printed sources, providing some interesting insights into the discovery of one of the most significant palaeontological sites in Slovenia - the cave of Mokriška jama.

The monograph »Fragments of Ice Age environments« is dedicated to the anniversary of the prominent researcher of the Slovenian Palaeolithic - Ivan Turk. His work, main achievements and selected bibliography are briefly presented in the introductory chapter.

2011, (Opera Instituti Archaeologici Sloveniae, 21), 280 pages, 44 b-w photographs, 10 drawings, 52 tables, 71 graphs and 9 maps, 20 × 29 cm, hardcover, ISBN 978-961-254-257-3.

Price: EUR 45.00

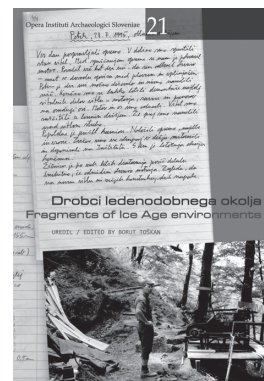

Anton Velušček (ed.)

## Spaha

In the collected papers the results of the research on hilltop settlement Spaha above Brezovica pri Predgradu are introduced. The site was excavated by Greta Hirschbäck-Merhar during the years 1979 and 1984.

Spaha was settled in the period of Sava group, Lasinja culture, horizon of pottery with furrowed incisions, and probably also in the period of Urnfield culture. In the 16th century on the top of Spaha a watchtower was erected, from which the local community was being informed about the arrivals of plundering hordes of Turks. The reasons for the settling the top of the hill are searched in the appearance of first copper ore prospectors in this part of Europe and in the vicinity of deposits of raw material used for querns which were most probably used by agriculture communities of nearby Bela krajina.

In the monograph are presented the relative and absolute chronologies of the Neolithic and earlier Eneolithic period of continental Slovenia.

2011, (Opera Instituti Archaeologici Sloveniae, 22), 296 pages, 88 b-w and colour photos, drawings and charts, 31 tables, 27 graphs and 42 plates, 21 x 29 cm, hardcover, ISBN 978-961-254-290-0.  
Price: EUR 47.00



Slavko Ciglenečki, Zvezdana Modrijan, Tina Milavec  
(with contributions of Benjamin Štular, Saša Čaval, Ivan Šprajc)

## Poznoantična utrjena naselbina Tonovcov grad pri Kobaridu Naselbinski ostanki in interpretacija Late Antique fortified settlement Tonovcov grad near Kobarid Settlement remains and interpretation

This monograph presents the results of archaeological investigations of the Late Antique fortified hilltop settlement Tonovcov grad near Kobarid. This settlement is one of the best preserved Late Antique settlements in Slovenia and the southeastern Alpine area. In the first chapters, the geographical position and the research history are presented. Following are the overview of archaeological sites in the Soča River valley and the road network in Late Antiquity.

Investigations, performed between 1993 and 2005, revealed the remains of three early Christian churches, some dwelling houses and a water cistern. The book presents the stratigraphic situation and the settlement phases in all excavation areas (building 1, buildings 2 and 3, ecclesiastical complex, water cistern) as well as their dating. The first Late Antique settlement phase started in the middle of the 4th century and lasted to the first decades of the 5th century. Due to the strong building activities at the beginning of the 6th century, the buildings of the first phase were poorly preserved, however many small finds were found. The life in the settlement reached its peak in the 6th century. Buildings 1 and 2 and an ecclesiastical complex of three connected churches were built. The quality of the preservation of the churches enabled a broader study of early Christian architecture in the eastern Alpine and Adriatic area.

The settlement is placed in the broader framework of the western Slovenia and Friuli in the Late Antiquity. In the second half of the 4th century it represented an important part of the Late Roman defence system of Italy and in the 6th century this was a religious and administrative centre of the autochthonous inhabitants in the Soča River valley.

2011, (Opera Instituti Archaeologici Sloveniae, 23), 304 pages, 211 b-w and colour photos, drawings and charts, 5 inserts, 20 x 29 cm, hardcover, ISBN 978-961-254-331-0.  
Price: EUR 55.00

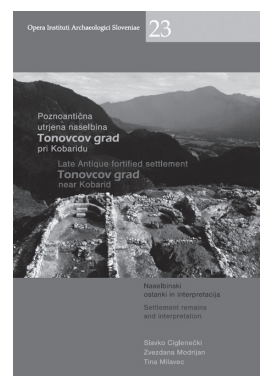





Založba ZRC / ZRC Publishing  
<http://zalozba.zrc-sazu.si>  
ISSN 1408-5208



55 €

